

EXHIBIT A:

Repealed Text for Chapter 23.48: SEATTLE MIXED

23.48.002 Scope of provisions

A. This Chapter 23.48 identifies uses that are or may be permitted in Seattle Mixed (SM) zones and establishes development standards. The SM zone boundaries are shown on the Official Land Use Map. The "D" suffix with a height limit range may be applied to SM zoned land in the West Dravus area.

B. Other regulations, such as requirements in Chapter 23.53 (streets, alleys and easements); Chapter 23.54 (standards for parking quantity, access and design); Chapter 23.54 (standards for solid waste storage); Chapter 23.55 (signs); and Chapter 23.86 (methods for measurements) may apply to development proposals. Communication utilities and accessory communication devices except as exempted in Section 23.57.002 are subject to the regulations in this Chapter 23.48 and additional regulations in Chapter 23.57.

Subchapter I - Use Provisions

23.48.004 Uses

A. Permitted uses

1. All uses are permitted outright, either as principal or accessory uses, except those specifically prohibited by subsection 23.48.004.B and those permitted only as conditional uses by subsection 23.48.004.C.

2. Adult cabarets shall comply with the requirements of subsection 23.47A.004.H.

3. In the SM 85-240 zone, permitted nonresidential uses are limited to a height of 20 feet above the street-level of structures with residential uses and are subject to the development standards of subsection 23.48.014.B.

B. Prohibited uses. The following uses are prohibited as both principal and accessory uses, except as otherwise noted:

1. All high-impact uses;
2. All heavy manufacturing uses;
3. General manufacturing uses greater than 25,000 square feet of gross floor area for an individual business establishment;
4. Drive-in businesses, except gas stations;
5. Jails;
6. Adult motion picture theaters and adult panorams;
7. Outdoor storage, except for outdoor storage associated with florists and horticulture uses;
8. Principal use surface parking;
9. Animal shelters and kennels;
10. Animal husbandry;
11. Park and pool lots;
12. Park and ride lots;
13. Work release centers;
14. Recycling;
15. Solid waste management; and
16. Mobile home parks.

C. Conditional uses

1. Conditional uses are subject to the procedures described in Chapter 23.76, Procedures for Master Use Permits and Council Land Use Decisions, and shall meet the provisions of both Section 23.42.042 and this subsection 23.48.004.C.

2. Mini-warehouses and warehouses may be permitted by the Director as administrative conditional uses if:

- a. The street level portion of a mini-warehouse or warehouse only fronts on an east/west oriented street, or an alley; and
- b. Vehicular entrances, including those for loading operations, will not disrupt traffic or transit routes; and
- c. The traffic generated will not disrupt the pedestrian character of an area by significantly increasing the potential for pedestrian-vehicle conflicts.

D. Required street-level uses

1. One or more of the uses listed in this subsection 23.48.004.D are required at street-level on all lots abutting streets designated as Class 1 Pedestrian Streets shown on Map A for 23.48.014, except as required in subsection 23.48.004.D.3. The following uses qualify as required street-level uses:

- a. General sales and service uses;
- b. Eating and drinking establishments;
- c. Entertainment uses;
- d. Public libraries;
- e. Public parks; and
- f. Arts facilities.

2. Standards for required street-level uses. Required street-level uses shall meet the development standards in subsection 23.48.014.E.

3. Within the SM 160/85-240 zone, for development meeting the standards in subsection 23.48.017.B, structures with a street-facing façade along 8th Avenue N. or a designated neighborhood green street (Map A for 23.48.014) shall have a minimum of 10 percent of the length of the street-level portion of that street-facing facade occupied by general sales and service uses, eating and drinking establishments, or entertainment uses, that shall meet the development standards for required street-level uses in subsection 23.48.014.E.

Subchapter II - Development Standards

23.48.008 Lot area limits for nonresidential uses in the SM/R 55/85 zone

A. In the SM/R 55/85 zone, development with nonresidential uses only, except hotels with 100 rooms/suites or fewer, is limited to a lot area of 21,600 square feet or less.

B. Development on lots greater than 21,600 square feet in area shall include residential use in an amount of gross floor area equal to 60 percent or more of the gross floor area in nonresidential use, except for development that is an elementary or secondary school, or a hotel with 100 rooms/suites or fewer.

C. Two lots of up to 21,600 square feet each, separated by an alley and connected above grade by a skybridge or other similar means shall be considered two separate lots for the purposes of this Section 23.48.008. Such a connection above grade, across the alley may be allowed pursuant to the City Council's approval of an aerial alley vacation or temporary use permit.

D. Nonresidential structures on adjacent lots not separated by an alley, subject to this Section 23.48.008, shall not be internally connected.

E. Nonresidential uses existing prior to November 6, 1996 that do not meet the requirements of Section 23.48.006 are allowed to expand by an amount of gross floor area not to exceed 20 percent of the existing gross floor area, without meeting the requirements of this Section 23.48.008. This provision may only be used once for an individual use.

F. Nonresidential use exception. A nonresidential structure may be permitted where a residential or mixed use structure would otherwise be required, subject to the following:

1. The proposal is comprised of two or more lots within the same SM/R zone;
and

2. The amount of gross floor area in residential use in the structures on both lots is equal to at least 60 percent of the total gross floor area of the total combined development on the lots included in the proposal; and

3. The nonresidential structure is subject to design review to ensure compatibility with the residential character of the surrounding area; and

4. The proposal meets one or more of the following:

a. The project includes the rehabilitation of a landmark structure or incorporates structures or elements of structures of architectural or historical significance as identified in the Seattle Comprehensive Plan or design guidelines; or

b. The project includes general sales and service uses, eating and drinking establishments, major durables retail sales uses, entertainment uses, human service uses or child care centers at the street level in an amount equal to 50 percent of the structure's footprint; or

c. On the lot(s) accommodating the required amount of residential use, as specified in subsection 23.48.008.F.2, a minimum of 10 percent of all new housing units in the proposal are provided as affordable housing as defined in Chapter 23.58A, and shall be maintained as affordable housing for a period of at least 20 years, or a minimum of 10 percent of all new housing units in the proposal are provided as townhouses.

23.48.009 Floor area ratio

A. General provisions

1. All gross floor area not exempt under subsection 23.48.009.D counts toward the maximum gross floor area allowed under the floor area ratio (FAR) limits.

2. The applicable FAR limit applies to the total non-exempt gross floor area of all structures on the lot.

3. If a lot is in more than one zone, the FAR limit for each zone applies to the portion of the lot located in that zone.

B. Floor Area Ratio (FAR) limits in SM zones

1. Except as otherwise specified in this subsection 23.48.009.B, FAR limits in SM zones exclusive of specified SM zones within the South Lake Union Urban Center are as shown in Table A for 23.48.009.

Table A for 23.48.009		
Floor Area Ratios in Seattle Mixed Zones, excluding specified SM zones within the South Lake Union Urban Center		
ZONE	Base FAR for all uses	Maximum FAR for all uses
SM 40	3	3.5
SM 65	3.5	5
SM 85	4.5 (1)	6 (1)
SM 125	5	8
SM 160	5	9
SM 240	6	13
SM/R 55/85	NA	NA
SM/D 40-85	NA	NA

Footnotes for Table A for 23.48.009:
 NA (not applicable) refers to zones where uses are not subject to an FAR limit.
 (1) Within the area shown on Map A for 23.48.009, all gross floor area occupied by a residential use is exempt from FAR calculations.

2. Except as otherwise specified in this subsection 23.48.009.B, FAR limits for specified SM zones within the South Lake Union Urban Center are as shown in Table B for 23.48.009.

Table B for 23.48.009			
FAR Limits for Specified Zones in South Lake Union Urban Center			
Zone	FAR limits for nonresidential uses		Maximum FAR for structures that do not exceed the base residential height limit and include any residential use.
	Base FAR	Maximum FAR	
SM 85/65-125	4.5	6	4.5
SM 85/65-160	4.5	7	4.5
SM 160/85-240	4.5*	7	6
SM 85-240	0.5	NA	6

Table B for 23.48.009 FAR Limits for Specified Zones in South Lake Union Urban Center			
Zone	FAR limits for nonresidential uses		Maximum FAR for structures that do not exceed the base residential height limit and include any residential use.
	Base FAR	Maximum FAR	
SM 240/125- 400	5*	7	10
*In the SM 160/85-240, and SM 240/125-400 zones, an additional increment of 0.5 FAR above the base FAR is permitted on lots meeting conditions of 23.48.009.B.4.			

3. FAR for development including a mix of residential and nonresidential uses.

a. For zones included on Table B for 23.48.009, development including a mix of nonresidential uses and residential uses that do not exceed the base height limit for residential use shall:

1) obtain extra floor area for any chargeable nonresidential floor area above the base FAR for nonresidential uses as prescribed in Table B for 23.48.009; and

2) not exceed the lower of the maximum FAR for nonresidential uses in Table B of 23.48.009 or the maximum FAR for structures that do not exceed the base height limit and include any residential use in Table B of 23.48.009.

b. For the SM 160/85-240 and SM 240/125-400 zones, residential uses are allowed above the base height limit in structures having nonresidential uses that exceed 85 feet in height, if the following conditions are met:

1) All uses are subject to the maximum FAR limit for nonresidential uses in Table B for 23.48.009, and for the purposes of calculating FAR, floor area in residential use shall be included as chargeable floor area;

2) If residential and nonresidential uses are combined on the same story, the floor area limits of subsection 23.48.013.B.3 apply;

3) Stories occupied only by residential uses may exceed the maximum height limit for nonresidential uses, and all stories above the base height limit for residential use that are only occupied by residential uses are subject to the floor area limits of 23.48.013.B.2 and the maximum façade width standards of 23.48.013.E;

4) Extra residential floor area above the base height limit for residential use shall be obtained as provided for in Section 23.48.011;

5) Extra nonresidential floor area above the base FAR for nonresidential uses shown on Table B for 23.48.009 shall be obtained as provided for in Section 23.48.011; and

6) For the purposes of applying standards for limits on towers per block in subsection 23.48.013.F, the project shall be considered to be a structure with nonresidential uses exceeding 85 feet in height; and

7) For the purposes of applying tower separation standards in subsection 23.48.013.G, the structure shall be considered to be a residential tower.

4. For the zones included on Table B for 23.48.009, an additional increment of up to 0.5 FAR is permitted for nonresidential uses above the base FAR of the zone if a lot meets the conditions of either subsection 23.48.009.B.4.a or subsection 23.48.009.B.4.b.

a. The lot includes one or more qualifying Landmark structures, subject to the following conditions:

1) The structure is rehabilitated to the extent necessary so that all features and characteristics controlled or designated by ordinance pursuant to Chapter 25.12 are in good condition and consistent with the applicable ordinances and with any certificates of approval issued by the Landmarks Preservation Board, all as determined by the Director of Neighborhoods; and

2) A notice is recorded in the King County real estate records, in a form satisfactory to the Director, regarding the bonus allowed and the effect thereof under the terms of this Chapter 23.48.

3) For purposes of this Section 23.48.009, a "qualifying Landmark" is a structure that:

a) is subject, in whole or in part, to a designating ordinance pursuant to Chapter 25.12; and

b) is on a lot on which no improvement, object, feature or characteristic has been altered or removed contrary to any provision of Chapter 25.12 or any designating ordinance.

4) A qualifying Landmark that allows for the additional increment of FAR under this subsection 23.48.009.B.4 is not eligible as a Landmark TDR or Landmark TDP sending site. For so long as any of the chargeable floor area of the increment allowed above the base FAR of the zone under this subsection 23.48.009.B.4 remains on the lot, each Landmark for which the increment was granted shall remain designated as a Landmark under Chapter 25.12 and the owner shall maintain the exterior and interior of each qualifying Landmark in good condition and repair and in a manner that preserves the features and characteristics that are subject to designation or controls by ordinance unless the Landmarks Preservation Board has issued a Certificate of Approval for the modification or demolition of the Landmark.

5) The amount of additional increment of FAR permitted above the base FAR under subsection 23.48.009.B.4 is not more than the square footage of floor area in the Landmark structure(s).

b. The lot includes an open space that is a minimum of 10,000 square feet in area and that has been improved as open space accessible to the public prior to the effective date of this ordinance, subject to the following conditions:

1) The Director, in consultation with the Director of the Seattle Parks and Recreation Department, determines that the design and location of the open space provides a public benefit and is suitable for recreational use;

2) Declaration. The owner(s) of the lot where the open space is located shall execute and record a declaration and voluntary agreement in a form acceptable to the Director identifying the open space provided to qualify for the additional increment of FAR above the base FAR; acknowledging that the right to develop and occupy a portion of the gross floor area on the lot using the additional increment of floor area is based upon the long-term provision and maintenance of the open space and that development is restricted in the open space; and committing to provide and maintain the open space; and

3) Duration; Alteration. The owners of the lot granted the additional increment of floor area above the base FAR as a result of having the open space on the lot shall provide and maintain the open space for as long as the increment of additional floor area allowed above the base FAR exists. The open space amenity allowing for the additional increment of floor area above the base FAR may be altered or removed only to the extent that either or both of the following occur: An amount of chargeable floor area equal to the increment of floor area allowed above the base FAR under this subsection 23.48.009.B.4.b is

a) removed or converted to a use for which extra nonresidential floor area is not required under the provisions of the zone; or

b) is subject to provisions for gaining extra nonresidential floor area through alternative means consistent with the provisions of the zone and provisions for allowing extra nonresidential floor area in Chapter 23.58A. Alteration or removal of the open space may be further restricted by the provisions of the zone and by conditions of any applicable permit.

4) The amount of extra FAR permitted above the base FAR is not more than three times the square footage of open space provided to qualify for that increment of FAR.

5. In the SM 85/65-160 zone on the blocks bounded by Valley Street, Mercer Street, Westlake Avenue North, and Fairview Avenue North, hotel use is permitted above 85 feet in height and is subject to the same provisions as residential use exceeding the base height limit for residential use, provided that all development standards that apply to a residential tower also apply to the hotel use, including the provisions of Section 23.48.011 for gaining extra residential floor area.

6. In the SM 85/65-125, SM 85/65-160, SM 160/85-240, SM 85-240, and SM 240/125-400 zones within South Lake Union Urban Center, for residential tower structures that have only nonresidential uses up to or above the base height limit for residential uses, the FAR limits for all nonresidential uses in the structure are the same as the FAR limits specified for nonresidential uses in Table B for 23.48.009.

7. On lots with multiple structures that include a residential tower exempt from FAR calculations, the applicable FAR limits for all other structures shall be based on the total lot area minus the area of the lot required for the podium and residential tower development in order to meet the coverage limit of subsection 23.48.013.A. For the portion of the lot with the residential tower, the FAR limit for permitted nonresidential uses in a residential tower that is also a mixed use structure shall be based on the area of the portion of the lot occupied by the residential tower.

8. Within the area in the SM 160/85-240 zone meeting the standards for location in subsection 23.48.017.B, structures designed for research and development laboratory use and administrative office associated with research and development laboratories are permitted a base FAR of 5 and a maximum FAR of 7, provided that the maximum number of floors provided above grade is eight.

9. Within zones that have an incentive zoning suffix, the number in the suffix shall be the base floor area ratio.

C. All non-exempt floor area above the base floor area ratio is considered extra floor area. Extra floor area may be obtained, up to the maximum floor area ratio, only through the provision of public amenities meeting the standards of Section 23.48.011 and Chapter 23.58A.

D. The following floor area is exempt from maximum FAR limits:

1. All gross floor area underground.

2. Portions of a story that extend no more than 4 feet above existing or finished grade, whichever is lower, excluding access, to increase privacy for residential units in the first full story above grade.

3. The floor area contained in a Landmark structure subject to controls and incentives imposed by a designating ordinance if the owner of the Landmark has executed and recorded an agreement acceptable in form and content to the Landmarks Preservation Board providing for the rehabilitation and maintenance of the historically significant features of the structure including but not limited to a Certificate of Approval for the modification of the Landmark. This exemption does not apply to a lot from which a Landmark TDP or TDR has been transferred under Chapter 23.58A and does not apply for purposes of determining TDR or TDP available for transfer under Chapter 23.58A.

4. As an allowance for mechanical equipment, in any structure 65 feet in height or more, 3.5 percent of the total chargeable gross floor area in a structure is exempt from FAR calculations. Calculation of the allowance includes the remaining gross floor area after all exempt space allowed in this subsection 23.48.009.D has been deducted. Mechanical equipment located on the roof of a structure, whether enclosed or not, is not included as part of the calculation of total gross floor area.

5. All gross floor area for solar collectors and wind-driven power generators.

6. In the South Lake Union Urban Center, street-level uses identified in subsection 23.48.004.D, whether required or not, and that meet the development standards of subsection 23.48.014.E; except that at locations meeting the conditions of Section 23.48.017, only gross floor area at street-level that is a general sales and service, eating and drinking establishment, or entertainment use is exempt.

7. In the South Lake Union Urban Center, all residential use in a residential tower in the SM 85/65-125, SM 85/65-160, SM 160/85-240, SM 85-240, and SM 240/125-400 zones, except residential use in a mixed use project under the provisions of 23.48.009.3.b.

8. In the SM 85/65-160 zone on the blocks bounded by Valley Street, Mercer Street, Westlake Avenue North, and Fairview Avenue North, all floor area in hotel use pursuant to subsection 23.48.009.B.5.

9. In the South Lake Union Urban Center, floor area in child care use and elementary and secondary schools.

10. In the SM 85 zone shown on Map A for 23.48.009, all gross floor area occupied by a residential use.

Map A for 23.48.009:

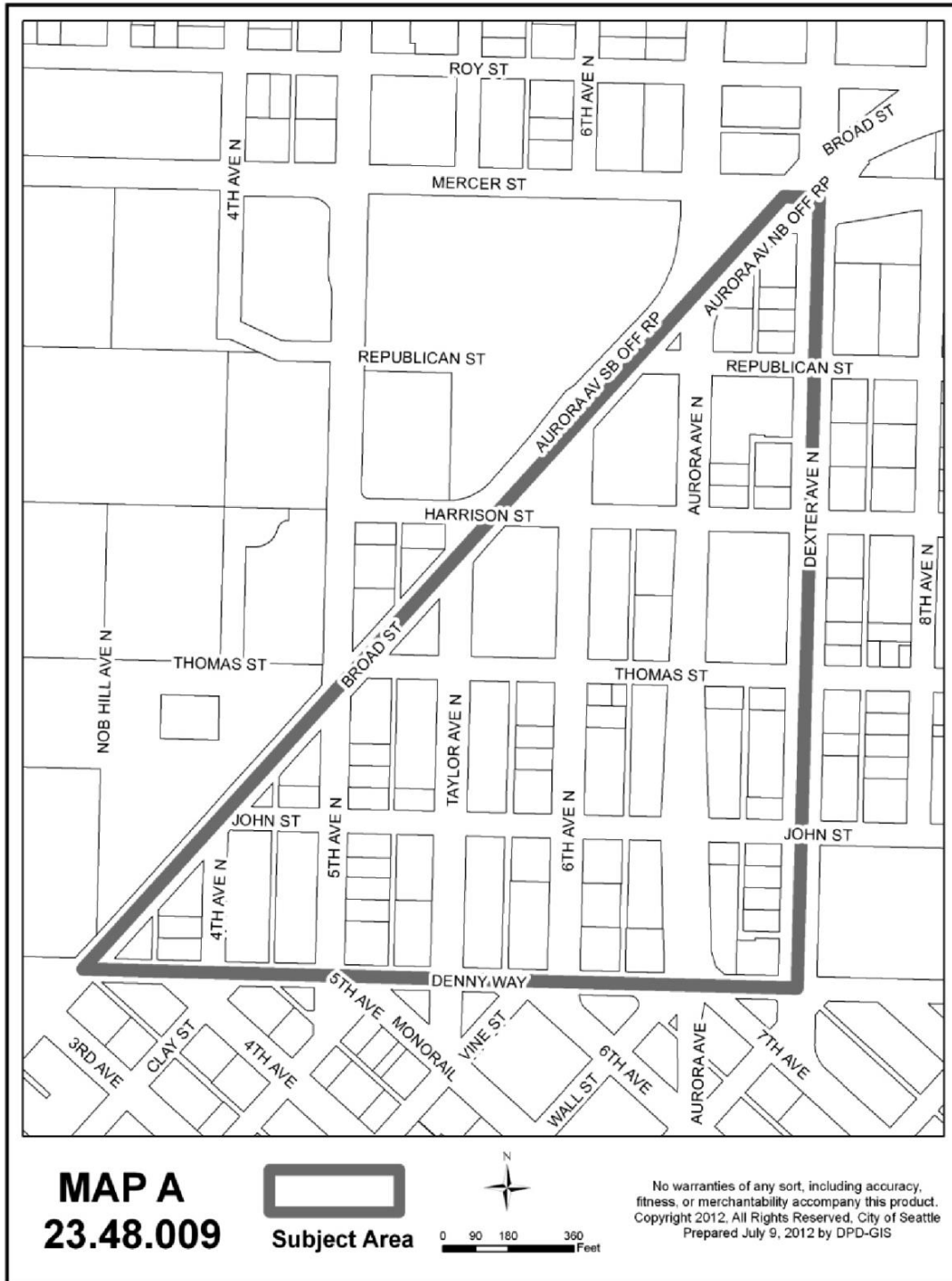

E. Minimum FAR

1. A minimum FAR shown in Table C for 23.48.009 is required whenever more than 1,000 square feet of gross floor area is added to or removed from a lot located in a Station Area Overlay District and abutting a Class 1 or Class 2 Pedestrian Street.

Table C for 23.48.009: Minimum Floor Area Ratio (FAR)						
Height Limit	40 feet	65 feet	85 feet	125 feet	160 feet	240 feet
Minimum FAR	1.5	2	2	2.5	2.5	3

2. The minimum FAR requirement provided in subsection 23.48.009.E.1 does not apply if:

- a. additional floor area is added to an existing structure on a lot that is nonconforming with respect to the minimum FAR shown in Table C for 23.48.009;
- b. the lot is larger than five acres;
- c. all existing gross floor area is demolished to create a vacant lot; or
- d. parks and open space is the principal use of the lot.

3. Portions of the lot designated as a steep slope, wetland, or riparian corridor or as a buffer to one of these areas, as defined in Chapter 25.09, shall not be included when calculating lot size for the purpose of determining the minimum FAR requirement provided in subsection 23.48.009.E.1.

4. The Director, in consultation with the Director of the Department of Neighborhoods, may waive the minimum FAR requirement provided in subsection 23.48.009.E.1 for lots that contain a designated landmark, or for lots within a Landmark District pursuant to Title 25 or within a Special Review District pursuant to Chapter 23.66, if the Director determines a waiver is necessary to preserve the integrity of a landmark or meet adopted District design and development guidelines.

5. The following gross floor area is not counted toward the minimum FAR requirement provided in subsection 23.48.009.E.1:

- a. Gross floor area below grade; and
- b. Gross floor area containing parking.

23.48.010 Structure height

A. Base and maximum height limits

1. Except as otherwise provided in this Section 23.48.010, maximum structure height for Seattle Mixed (SM) zones are as designated on the Official Land Use Map. In certain zones, as specified in this Section 23.48.010, the maximum structure height is allowed only for particular uses or only under specified conditions, or both. Where height limits are established for portions of a structure that contain specified types of uses, the applicable height limit for the structure is the highest applicable height limit for the types of uses in the structure, unless otherwise specified.

2. In zones listed below in this subsection 23.48.010.A.2, the applicable height limit for portions of a structure that contain nonresidential and live-work uses is shown as the first figure after the zone designation, and the base height limit for portions of a structure in residential use is shown as the first figure following the "/". The third figure shown is the maximum residential height limit. Except as stated in Section 23.48.010 (height exceptions), the base residential height limit is the applicable height limit for portions of a structure in residential use if the structure does not gain extra residential floor area under the provisions of Chapter 23.58A, and the maximum residential height limit is the height limit for portions of a structure in residential use if the structure includes extra floor area under the provisions of Chapter 23.58A and if the structure complies with the standards for tower development specified in Section 23.48.013 (Upper-level development standards) and Section 23.48.014 (street-level development standards):

SM 85/65-125

SM 85/65-160

SM 160/85-240

SM 240/125-400

3. In the SM 85/65-160 zone on the blocks bounded by Valley Street, Mercer Street, Westlake Avenue North, and Fairview Avenue North, hotel use is permitted above 85 feet in height and is subject to the same provisions as residential use exceeding the base height limit for residential use, provided that all development standards that apply to a residential tower also apply to the hotel use, including the provisions of Section 23.48.011 for gaining extra residential floor area.

4. In the SM 85-240 zone, the base height limit is shown as the first figure, and the second figure is the maximum residential height limit. Except as stated in subsections 23.48.010.G and 23.48.010.H, the base height limit is the applicable height limit for portions of a structure if the structure does not gain extra residential floor area under the provisions of Chapter 23.58A, and the maximum residential height limit is the height limit for portions of a structure in residential use if the structure includes extra residential floor area under the provisions of Chapter 23.58A, and if the structure complies with the standards for residential tower development in this Chapter 23.48.

B. Height limits in the SM/R 55/85 zone

1. New structures occupied only by nonresidential uses are subject to a height limit of 55 feet.

2. Structures occupied only by residential uses and mixed-use structures with 60 percent or more of the structure's gross floor area in residential use are subject to a height limit of 85 feet.

C. Height limits in the Seattle Mixed/Dravus 40-85 (SM/D 40-85) zone

1. Base height limit. Structures in the SM/D 40-85 zone are subject to a height limit of 40 feet, except as otherwise provided in subsection 23.48.016.C.2.

2. Additional height for structures with only residential uses above 40 feet. A structure in the SM/D 40-85 zone that has only residential uses above a height of 40 feet is subject to a maximum height limit of 85 feet, if the following conditions are met:

a. The applicant satisfies the conditions for bonus development under Section 23.48.011;

b. The portion of any structure above 45 feet in height shall be set back at least 50 feet from W. Dravus Street, except that the first 4 feet of the horizontal projection of decks, balconies with open railings, eaves, cornices, and gutters is permitted in the required setback, and the exceptions for pitched roofs and rooftop features of subsection 23.48.016.C.3 are allowed above the 45 foot height limit in the required setback.

3. Exceptions for pitched roofs and rooftop features. Additional height above the applicable limit pursuant to subsections 23.48.016.C.1, 23.48.016.C.2, or 23.48.016.C.2.b, is allowed for pitched roofs and certain rooftop features, as set forth in subsections 23.48.010.D and 23.48.010.E.

D. Additional height permitted in the SM 160/85-240 and SM 85-240 zones within the South Lake Union Urban Center

1. Increases in the maximum height limit in the SM 160/85-240 and SM 85-240 zones. In the SM 160/85-240 and SM 85-240 zones in the South Lake Union Urban Center, a structure is allowed additional height of up to 30 percent above the maximum height limit for residential uses, and, in the SM 160/85-240 zone, up to 20 percent above the height limit for nonresidential uses, if all of the following conditions are met:

a. The project includes an elementary school or a kindergarten through eighth grade school operated by the Seattle Public School District that meets the specifications promulgated by the Seattle Public School District, which may include minimum space requirements for academic core functions, child care, administrative offices, a library, maintenance facilities, food service, and specialty instruction space;

b. Prior to issuance of a Master Use Permit, the applicant shall submit a letter to the Director from the Seattle School District indicating that, based on the Master Use Permit plans, the school district has determined that the development could meet the School District's specifications;

c. Prior to issuance of a building permit, the applicant shall submit a written certification by the School District to the Director that the School District's specifications have been met;

d. The amount of floor area allowed to exceed the applicable height limit is equivalent to the amount of enclosed floor area on the lot in school use;

e. The floor area added through the increase in height is subject to the development standards in Sections 23.48.012 and 23.48.013 that apply to structures that exceed the base height for residential use or the applicable podium height for nonresidential uses;

f. The floor area allowed to exceed the maximum residential height limit is not subject to the provisions for gaining extra residential floor area in Chapter 23.58A; should the school use be discontinued, floor area gained through the provisions of this Section 23.48.010 shall be subject to the provisions of Chapter 23.58A; and

g. The allowances for rooftop features in subsection 23.48.010.G shall apply above the structure height permitted under this subsection 23.48.010.D.

2. Additional height above the applicable height limit for portions of a structure that contain nonresidential and live-work uses is permitted in the SM 160/85-240 zone at locations and under the conditions specified in Section 23.48.017.

E. A proposal to build a structure greater than 85 feet in height in the SM 85/65-160 and SM 160/85-240 zones and located north of Mercer Street and West of Fairview Avenue within the South Lake Union Urban Center, requires the applicant to show that the proposed structure height will not physically obstruct use of the flight path shown on Map A for 23.48.010 or endanger aircraft operations.

Map A for 23.48.010: South Lake Union Seaport Flight Corridor

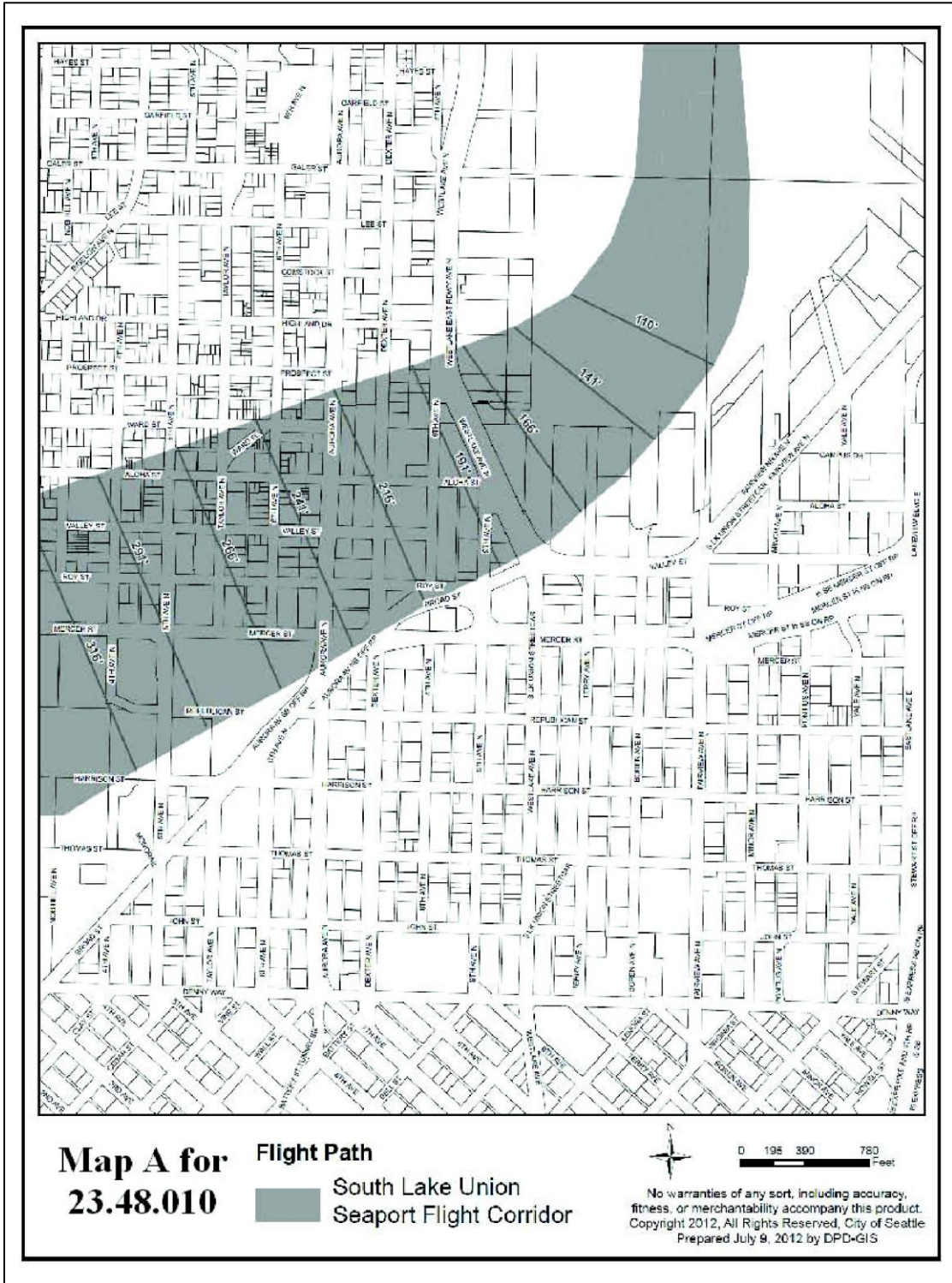

F. All non-exempt floor area located above the base height is considered extra floor area. Extra floor area may be obtained above the base height, up to the maximum height, only through the provision of public amenities meeting the standards of Section 23.48.011 and Chapter 23.58A.

G. Pitched roofs. In SM zones with a height limit of 85 feet or less, the ridge of a pitched roof with a minimum slope of 6 to 12 may extend 10 feet above the height limit. The ridge of a pitched roof with a minimum slope of 4 to 12 may extend 5 feet above the height limit (Exhibit A for 23.48.010). No portion of a shed roof shall be permitted to extend beyond the height limit under this provision.

Exhibit A for 23.48.010 Pitched Roofs

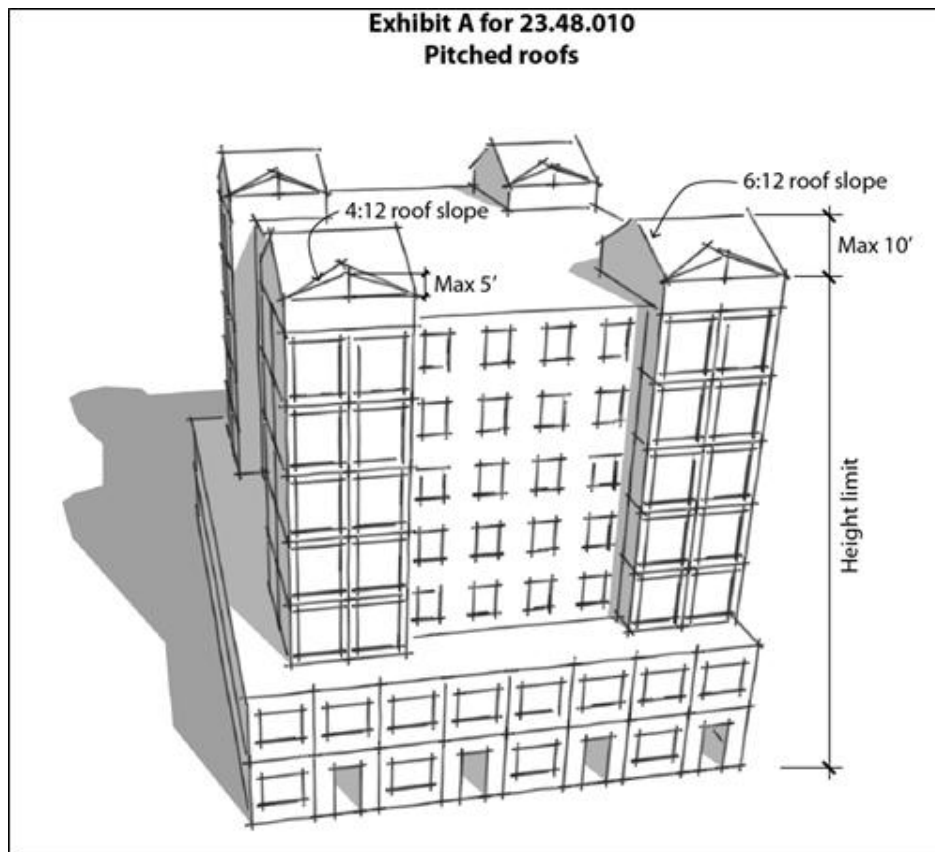

H. Rooftop features.

1. Smokestacks, chimneys, flagpoles, and religious symbols for religious institutions are exempt from height controls, except as regulated in Chapter 23.64, Airport Height Overlay District, provided they are a minimum of 10 feet from any side or rear lot line.

2. Open railings, planters, skylights, clerestories, greenhouses, parapets and firewalls may extend up to 4 feet above the maximum height limit with unlimited rooftop coverage.

3. Solar collectors may extend up to 7 feet above the maximum height limit, with unlimited rooftop coverage.

4. The following rooftop features may extend up to 15 feet above the maximum height limit, so long as the combined total coverage of all features listed in this subsection 23.48.010.H.4 does not exceed 20 percent of the roof area, or 25 percent of the roof area if the total includes stair or elevator penthouses or screened mechanical equipment:

- a. Solar collectors;
- b. Stair penthouses;
- c. Mechanical equipment;
- d. Atriums, greenhouses, and solariums;
- e. Play equipment and open-mesh fencing that encloses it, as long as the fencing is at least 15 feet from the roof edge;
- f. Minor communication utilities and accessory communication devices, except that height is regulated according to the provisions of Section 23.57.012; and
- g. Covered or enclosed common amenity area for structures exceeding a height of 125 feet.

5. For structures greater than 85 feet in height, elevator penthouses up to 25 feet above the height limit are permitted. If the elevator provides access to a rooftop designed to provide usable open space, elevator penthouses up to 35 feet above the height limit are permitted.

6. Greenhouses that are dedicated to food production are permitted to extend 15 feet above the applicable height limit, as long as the combined total coverage of all features gaining additional height listed in this subsection 23.48.010.H does not exceed 50 percent of the roof area.

7. At the applicant's option, the combined total coverage of all features listed in subsections 23.48.010.H.4 and 23.48.010.H.5 above may be increased to 65 percent of the roof area, provided that all of the following are satisfied:

- a. All mechanical equipment is screened; and
- b. No rooftop features are located closer than 10 feet to the roof edge.

8. In order to protect solar access for property to the north, the applicant shall either locate the rooftop features listed in this subsection 23.48.010. H.8 at least 10 feet from the north edge of the roof, or provide shadow diagrams to demonstrate that the proposed location of such rooftop features would shade property to the north on January 21st at noon no more than would a structure built to maximum permitted bulk:

- a. Solar collectors;
- b. Planters;
- c. Clerestories;
- d. Atriums, greenhouses and solariums;
- e. Minor communication utilities and accessory communication devices

according to the provisions of Section 23.57.012;

- f. Nonfirewall parapets;
- g. Play equipment.

9. Screening. Rooftop mechanical equipment and elevator penthouses shall be screened with fencing, wall enclosures, or other structures.

10. For height limits and exceptions for communication utilities and accessory communication devices, see Section 23.57.012.

23.48.011 Extra floor area in Seattle Mixed zones

A. General

1. Developments containing extra floor area obtained under Sections 23.48.009 or 23.48.010 shall provide public amenities according to the standards of this Section 23.48.011 and Chapter 23.58A. If the development is not located within the Local Infrastructure Project Area for Downtown and South Lake Union as shown in Map A for 23.58A.044, extra floor area shall be achieved through the requirements of subsection 23.48.011.B. If the development is located within the Local Infrastructure Project Area for Downtown and South Lake Union as shown in Map A for 23.58A.044, extra floor area shall be achieved through the requirements of subsection 23.48.011.C.

2. Definitions in Section 23.58A.004 apply in this Section 23.48.011 unless otherwise specified.

B. Calculation outside of an adopted Local Infrastructure Project Area

1. Means to achieve extra residential floor area.

a. If the maximum height limit for residential use is 85 feet or lower or the lot is located outside of the South Lake Union Urban Center and the Mount Baker Station Area Overlay District, the applicant shall use bonus residential floor area for affordable housing pursuant to Section 23.58A.014 to achieve all extra residential floor area on the lot.

b. If the maximum height limit for residential use is greater than 85 feet and the lot is located in the South Lake Union Urban Center, the applicant shall:

1) achieve 60 percent of the extra residential floor area on the lot by using bonus residential floor area for affordable housing pursuant to Section 23.58A.014; and

2) achieve 40 percent of the extra residential floor area by using open space transferable development potential or Landmark transferable development potential pursuant to subsection 23.48.011.D and Section 23.58A.042.

c. If the maximum height limit for residential use is greater than 85 feet and the lot is located in the Mount Baker Station Area Overlay District, the applicant shall:

- 1) achieve 60 percent of the extra residential floor area on the lot by using bonus residential floor area for affordable housing pursuant to Section 23.58A.014; and
- 2) achieve 40 percent of the extra residential floor area by using open space amenities pursuant to Section 23.58A.040.

2. Means to achieve extra nonresidential floor area.

a. If the maximum height limit for nonresidential use is 85 feet or lower or the lot is located outside of the South Lake Union Urban Center and the Mount Baker Station Area Overlay District, the applicant shall use bonus nonresidential floor area for affordable housing and child care pursuant to Section 23.58A.024 to achieve all extra nonresidential floor area on the lot.

b. If the maximum height limit for nonresidential use is greater than 85 feet and the lot is located in the South Lake Union Urban Center, the applicant shall:

1) achieve 75 percent of the extra nonresidential floor area on the lot by using bonus nonresidential floor area for affordable housing and child care pursuant to Section 23.58A.024, or housing transferable development rights pursuant to subsection 23.48.011.D and Section 23.58A.042, or both.

2) achieve 25 percent of the extra nonresidential floor area by using open space transferable development rights or Landmark transferable development rights pursuant to subsection 23.48.011.D and Section 23.58A.042.

c. If the maximum height limit for nonresidential use is greater than 85 feet and the lot is located in the Mount Baker Station Area Overlay District, the applicant shall:

1) achieve 75 percent of the extra nonresidential floor area on the lot by using bonus nonresidential floor area for affordable housing pursuant to Section 23.58A.024; and

2) achieve 25 percent of the extra nonresidential floor area by using open space amenities pursuant to Section 23.58A.040.

3. If a development is outside of an adopted Local Infrastructure Project Area at the time a Master Use Permit decision is issued for the development, and the development is inside of an adopted Local Infrastructure Project Area before the first building permit after excavation and shoring is ready to issue for the development, then the applicant may elect to achieve extra floor area through acquiring regional development credits pursuant to Section 23.58A.044 for the portion of extra floor area specified in subsection 23.48.011.B.1.b or 23.48.011.B.2.b, as applicable, in lieu of the open space transferable development potential or Landmark transferable development potential specified in subsection 23.48.011.B.1.b, or the open space transferable development rights or Landmark transferable development rights specified in 23.48.011.B.2.b.

C. Calculation within an adopted Local Infrastructure Project Area

1. Means to achieve extra residential floor area. If the maximum height limit for residential use is 85 feet or lower, the applicant shall use bonus residential floor area for affordable housing pursuant to Section 23.58A.014 to achieve all extra residential floor area on the lot. If the maximum height limit for residential use is greater than 85 feet, the applicant shall:

a. achieve 60 percent of the extra residential floor area on the lot by using bonus residential floor area for affordable housing pursuant to Section 23.58A.014; and

b. achieve 40 percent of extra residential floor area by acquiring regional development credits pursuant to Section 23.58A.044.

2. Means to achieve extra nonresidential floor area. If the maximum height limit for nonresidential use is 85 feet or lower, the applicant shall use bonus nonresidential floor area for affordable housing and child care pursuant to Section 23.58A.024 to achieve all extra nonresidential floor area on the lot. If the maximum height limit for nonresidential use is greater than 85 feet, the applicant shall:

a. achieve 75 percent of the extra residential floor area on the lot by using bonus nonresidential floor area for affordable housing and child care pursuant to Section 23.58A.024, or housing transferable development rights pursuant to subsection 23.48.011.D and Section 23.58A.042, or both; and

b. achieve 25 percent of extra nonresidential floor area by acquiring regional development credits pursuant to Section 23.58A.044.

D. Standards for Transferable Development Potential (TDP) and Transferable Development Rights (TDR).

1. All lots in the South Lake Union Urban Center that meet the definition of a TDR or TDP sites in Chapter 23.84A are eligible for transfer.

2. Receiving sites in the South Lake Union Urban Center may only receive TDP or TDR from sending sites in the South Lake Union Urban Center except that receiving sites in the South Lake Union Center may receive Landmark or open space TDP or TDR from sending sites in Downtown or South Downtown if the applicant demonstrates to the satisfaction of the Director that no private or public entities are offering such TDP or TDR for sale in the South Lake Union Urban Center, at a price per square foot no greater than the fee-in-lieu rates for the payment option for affordable housing under Section 23.58A.014 for TDP and the payment option for affordable housing and childcare under Section 23.58A.024 for TDR.

3. A cumulative combination of TDR and TDP exceeding a total of five times the lot area may not be transferred from any lot.

E. Minimum requirement. Developments containing any extra floor area shall meet the following requirements:

1. LEED requirement.

a. Except as described in 23.48.011.E.1.b, the applicant will earn a LEED Gold rating or meet a substantially equivalent standard, and shall demonstrate compliance with that commitment, in accordance with the provisions of Section 23.48.025.

b. An applicant may choose to earn at least a LEED Silver rating, if the Director of the Office of Sustainability and Environment determines that the development is served by a district energy provider. A building is considered served by a district energy provider if it is capable of connecting to a district energy system and has a contract with a district energy utility to serve primary heating and/or cooling needs. A district energy provider is an entity with a franchise agreement with the City that maintains a closed-loop district energy utility system that is either currently or scheduled to primarily use renewable and/or waste heat sources, per the system development plans and timeframes of an agreement with the City and the district energy provider. A district energy provider may, subject to City approval, rely on a temporary on-site or near-by transitional plant that is installed and maintained by the provider prior to connection of the development to a permanent district energy system.

2. Transportation Management Program. The applicant will provide a Transportation Management Program (TMP), consistent with requirements for TMPs in any applicable Director's Rule, that demonstrates to the satisfaction of the Director in consultation with the Director of Transportation, that no more than 40 percent of trips to and from the development will be made using single-occupant vehicles (SOVs). The TMP shall be submitted with the Master Use Permit application.

a. For purposes of measuring the percent of trips to and from the development made using SOVs in the TMP, the number of SOV trips shall be calculated for the p.m. peak hour in which an applicant expects the largest number of vehicle trips to be made by employees at the site (the p.m. peak hour of the generator).

b. Compliance with this subsection 23.48.011.E.2 does not affect the responsibility of any employer to comply with Seattle's Commute Trip Reduction (CTR) Ordinance.

3. Energy management plan. The applicant will provide an energy management plan, approved by the Superintendent of Seattle City Light, demonstrating specific energy

conservation or alternative energy generation methods or on-site electrical systems that together can ensure that the existing electrical system can accommodate the projected loads from the development. The approved energy management plan shall be submitted prior to issuance of a Building Permit. The Director, after consulting with the Superintendent of Seattle City Light, may condition the approval of the Building Permit on the implementation of the energy management plan.

23.48.012 Upper-level setback requirements

A. The following requirements for upper-level setbacks in this subsection 23.48.012.A apply to structures on lots abutting a street shown on Maps A and B for 23.48.012, except for those structures in the South Lake Union Urban Center with nonresidential uses above 85 feet in height or residential uses above the base height limit for residential use, which are subject to the upper-level setback requirements of subsection 23.48.013.C.

1. For all zones except the SM 240/125-400 zone, any portion of a structure greater than 45 feet in height is required to set back from a lot line abutting a street shown on Maps A and B for 23.48.012. In the SM 240/125-400 zone, portions of a structure greater than 75 feet in height are required to set back from a lot line abutting a street shown on Map A for 23.48.012.

2. A setback of 1 foot for every 2 additional feet of height is required for any portion of a structure exceeding the maximum height permitted without a setback according to subsection 23.48.012.A.1, up to a maximum setback of 15 feet measured from the street lot line, as shown in Exhibit A for 23.48.012.

Map A for 23.48.012: Upper-Level Setbacks in South Lake Union

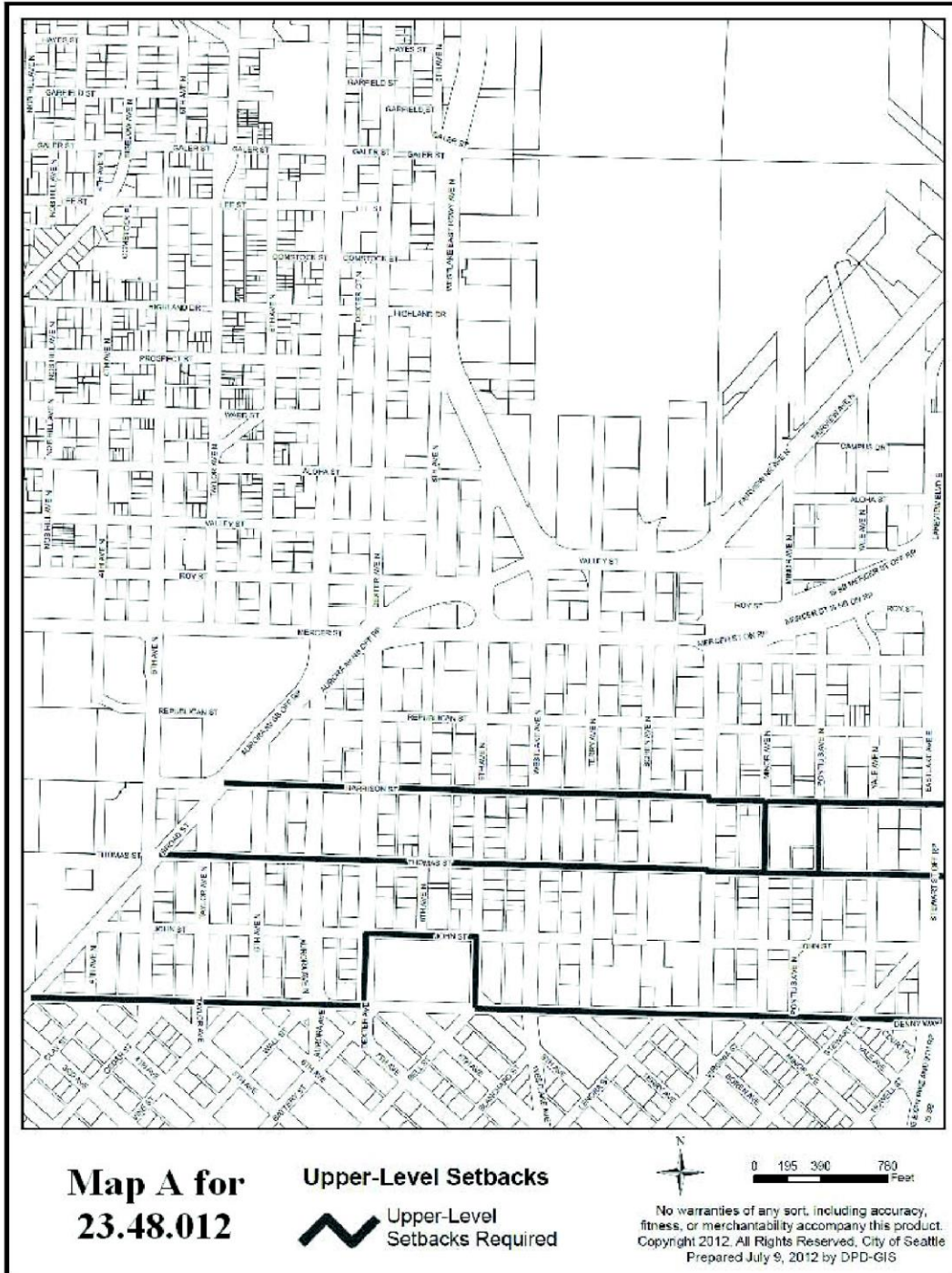

B. Upper-level setbacks in the SM 85/65-160 zone. The following requirements for upper-level setbacks in this subsection 23.48.012.B apply to all development in the SM 85/65-160 zone on the blocks bounded by Valley Street, Mercer Street, Westlake Avenue North, and Fairview Avenue North:

1. Portions of a structure above 45 feet in height shall set back a minimum of 15 feet from street lot lines abutting Valley Street, Westlake Avenue North, Terry Avenue North, Boren Avenue North, and Fairview Avenue North as shown in Exhibit B for 23.48.012.

2. In addition to the upper-level setbacks specified in subsection 23.48.012.B.1, additional upper-level setbacks are required for tower structures that include residential use above the base height limit for residential use, or hotel use above a height of 85 feet, according to the provisions of subsection 23.48.013.C.3.

**Exhibit A for 23.48.012
Stepped upper-level setbacks**

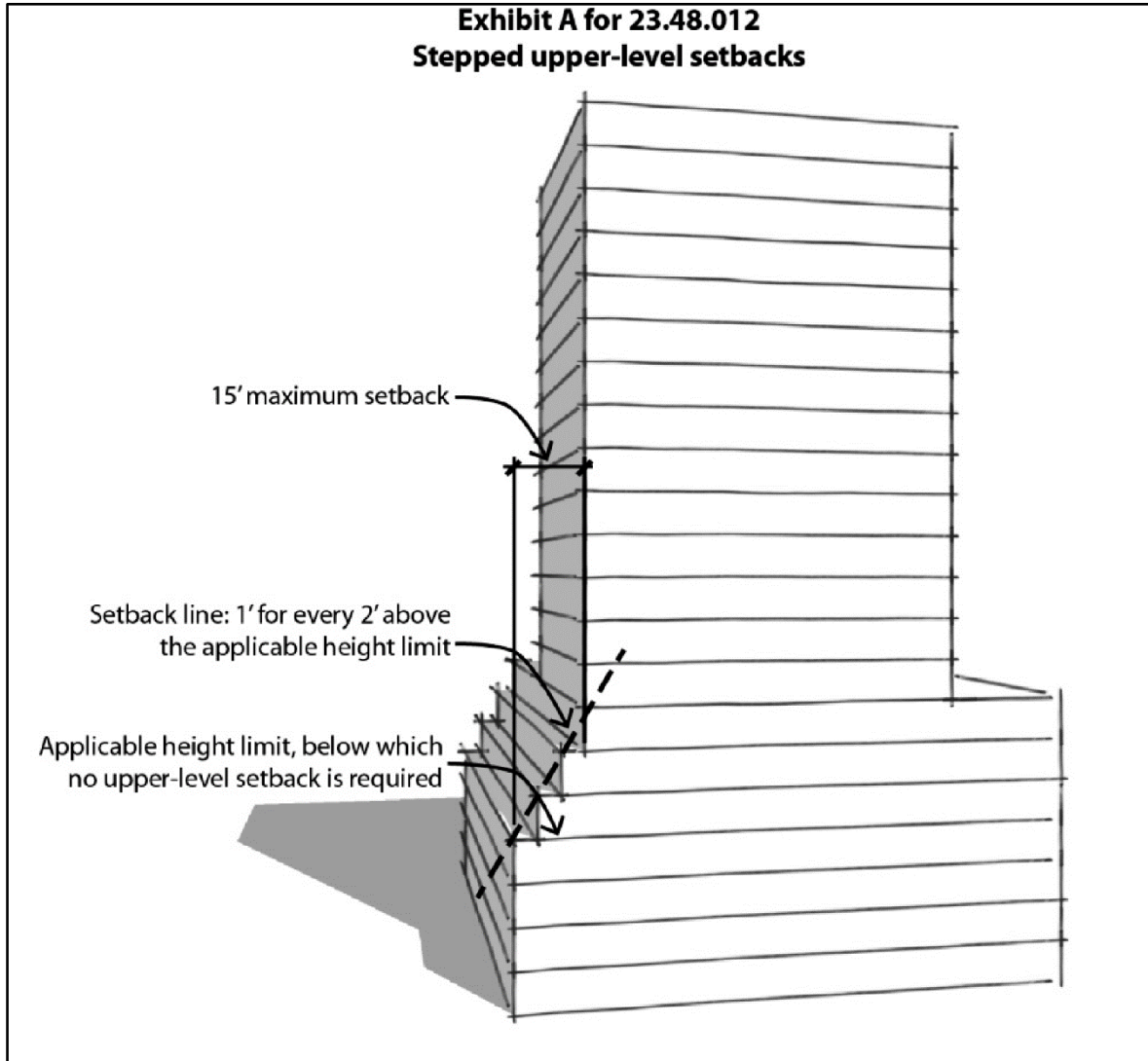
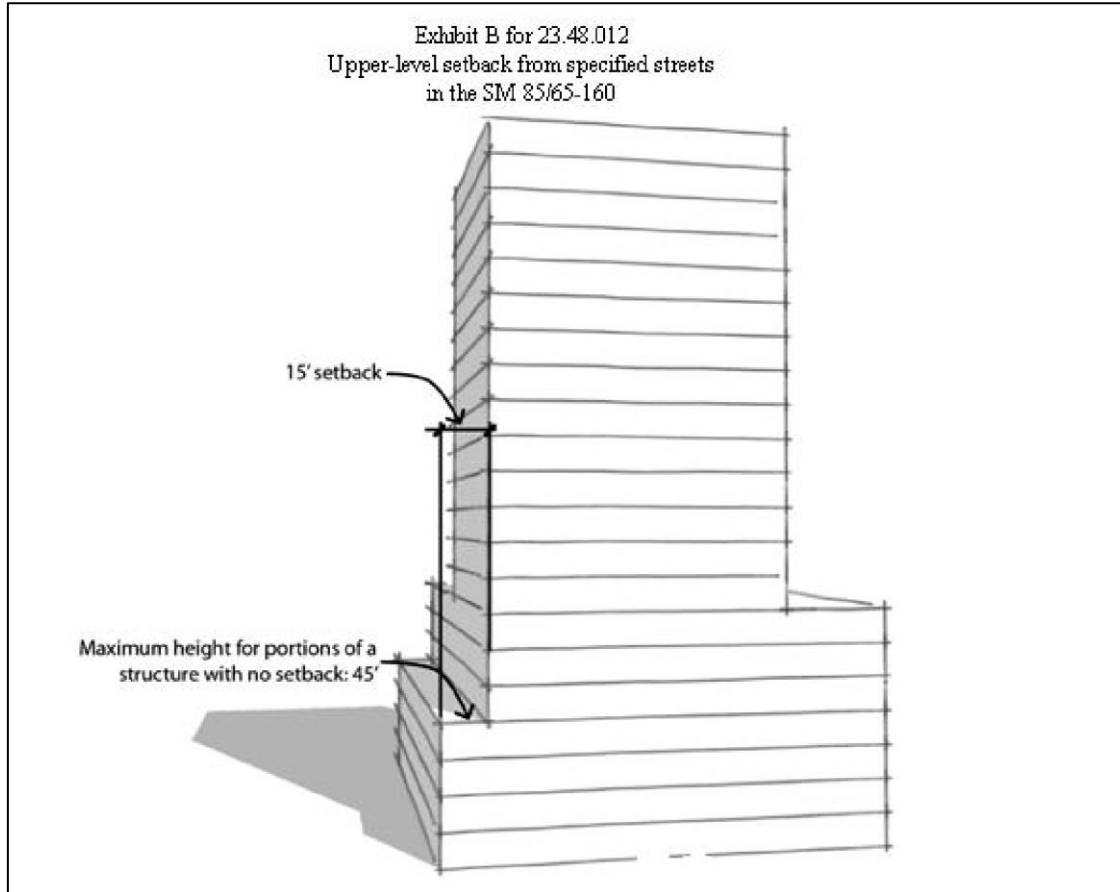

Exhibit B for 23.48.012
Upper-level setback from specified streets in the SM 85/65-160



C. Upper-level setbacks on alleys in the SM/R 55/85 zone. For lots abutting an alley in the SM/R 55/85 zone, portions of a structure greater than 25 feet in height shall set back a minimum of 1 foot from the alley lot line for every 2 feet of additional height above 25 feet, up to a maximum setback of 15 feet measured from the alley lot line, as shown in Exhibit A for 23.48.012.

D. Projections permitted in required upper-level setbacks. Horizontal projections, including decks, balconies with open railings, eaves, cornices, and gutters are permitted to extend a maximum of 4 feet in required setbacks (Exhibit C for 23.48.012).

Exhibit C for 23.48.012
Horizontal projection into upper-level setbacks

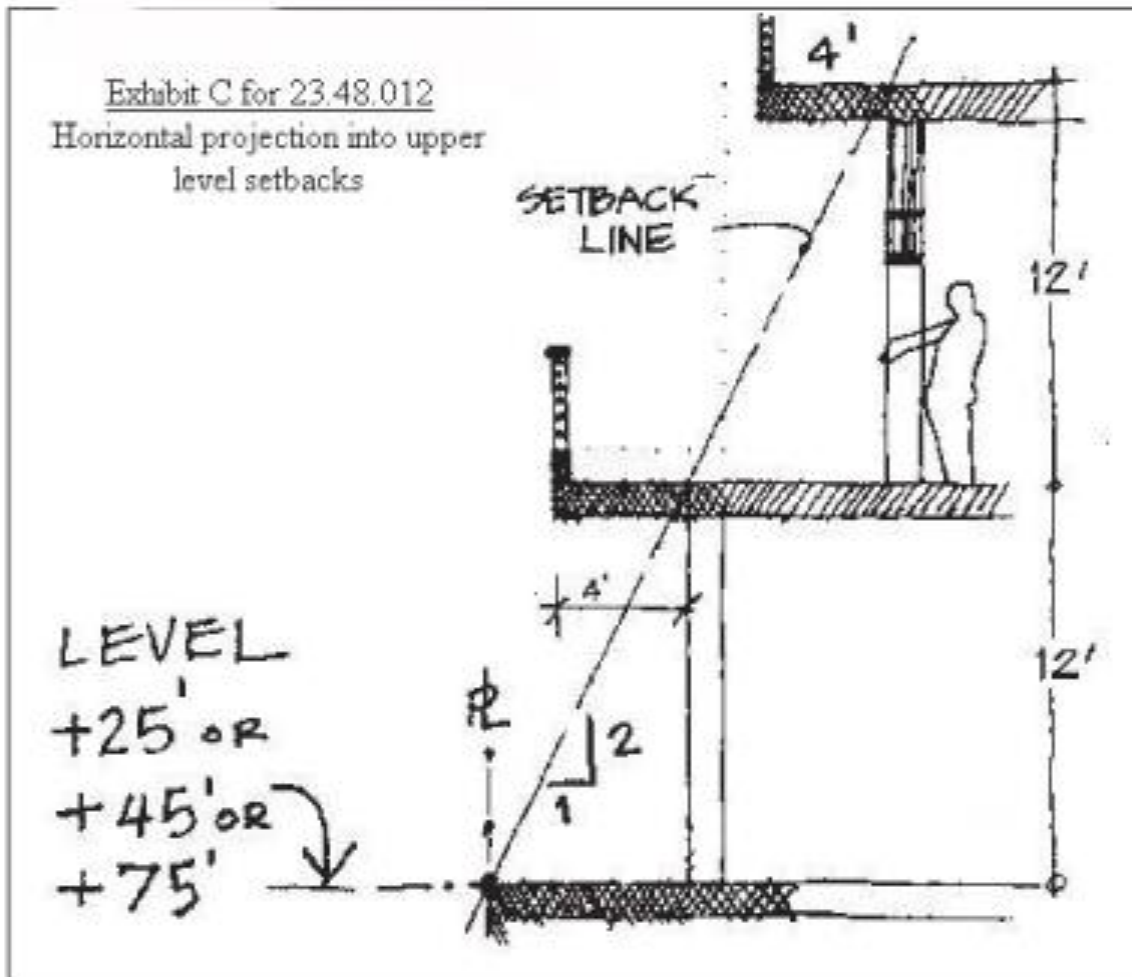

23.48.013 Upper-level development standards for specific building types in SM zones in the South Lake Union Urban Center

Lots in the SM 85/65-125, SM 85/65-160, SM 160/85-240, SM 85-240, and SM 240/125-400 zones that are located within the South Lake Union Urban Center are subject to upper-level development standards that may include upper level coverage limits, gross floor area limits and podium heights, upper-level setbacks, façade modulation, maximum facade widths, a limit on the number of towers per block, and tower separation requirements, as specified in this Section

23.48.013. For the purpose of this Section 23.48.013, a tower is either a structure with non-residential uses above a height of 85 feet, the podium, or a structure that has residential uses that exceed the base height limit established for residential uses in the zone under subsection 23.48.010.A.2.

A. Upper-level coverage limit. For residential towers, the average gross floor area of all stories above the podium height specified on Map A for 23.48.013 shall not exceed 50 percent of the lot area, provided that:

1. In no case shall the gross floor area of stories above the podium height exceed the gross floor area limits of subsection 23.48.013.B.2; and

2. The limit on towers per block in subsection 23.48.013.F apply.

B. Floor area limits and podium heights. The following provisions apply to development in the SM 85/65-125, SM 85-240, SM 85/65-160, SM 160/85-240, and SM 240/125-400 zones located within the South Lake Union Urban Center:

1. Floor area limit for structures or portions of structures occupied by non-residential uses.

a. Except as specified in subsections 23.48.013.B.1.b and 23.48.013.B.1.c, there is no floor area limit for nonresidential uses in a structure that does not contain nonresidential uses above 85 feet in height.

b. There is no floor area limit for a structure that includes research and development uses and does not exceed a height of 105 feet, provided that the following conditions are met:

1) A minimum of two floors in the structure are occupied by research and development uses and have a floor-to-floor height of at least 14 feet; and

2) The structure has no more than seven stories.

c. Within locations in the SM 160/85-240 zone meeting the standards in subsection 23.48.017.B, there is no floor area limit for structures that do not exceed a height of

120 feet and that are designed for research and development laboratory use and administrative office associated with research and development laboratories.

d. For structures with nonresidential uses that exceed a height of 85 feet, or that exceed the height of 105 feet under the provisions of subsection 23.48.013.B.1.b, or 120 feet under subsection 23.48.013.1.c, each story of the structure above the specified podium height indicated for the lot on Map A for 23.48.013 is limited to a maximum gross floor area of 24,000 square feet per story, except that the average gross floor area for stories above the specified podium height is 30,000 square feet for structures on a lot that meets the following conditions:

- 1) The lot has a minimum area of 60,000 square feet; and
- 2) The lot includes an existing open space or a qualifying

Landmark structure and is permitted an additional increment of FAR above the base FAR, as permitted in subsection 23.48.009.B.4.

2. Floor area limit for residential towers. For a structure with residential use that exceeds the base height limit established for residential uses in the zone under subsection 23.48.010.A.2, the following maximum gross floor area limit applies:

a. For a structure that does not exceed a height of 160 feet, excluding rooftop features that are otherwise permitted above the height limit under the provisions of subsection 23.48.010.I, the gross floor area for stories with residential use that extend above the podium height indicated for the lot on Map A for 23.48.013 shall not exceed 12,500 square feet per story, or the floor size established by the upper-level coverage limit in subsection 23.48.013.A, whichever is less.

b. For a structure that exceeds a height of 160 feet, the following limits apply:

- 1) The average gross floor area for all stories with residential use that extend above the podium height indicated for the lot on Map A for 23.48.013 shall not

exceed 10,500 square feet, or the floor size established by the upper-level coverage limit in subsection 23.48.013.A, whichever is less.

2) The gross floor area of any single residential story above the podium height shall not exceed 11,500 square feet.

3. Floor area limit for mixed use development. This subsection 23.48.013.B.3 applies to structures that include both residential and non-residential uses, as provided for in 23.48.009.3.b.

a. For a story that includes both residential and non-residential uses, the gross floor area limit for all uses combined shall not exceed the floor area limit for non-residential uses, provided that the floor area occupied by residential use shall not exceed the floor area limit otherwise applicable to residential use.

b. For a mixed use structure with residential uses located on separate stories from non-residential uses, the floor area limits shall apply to each use at the applicable height limit.

4. Podium standards. The standards for podiums only apply to projects that are subject to a floor area limit in this subsection 23.48.013.B, and apply only to the lower portion of the structure that are not subject to the floor area limit.

a. Height limit for podiums. The specific podium height for a lot is shown on Map A for 23.48.013, and the height limit extends from the street lot line to the parallel alley lot line, or, where there is no alley lot line parallel to the street lot line, from the street lot line to a distance of 120 feet from the street lot line, or to the rear lot line, if the lot is less than 120 feet deep.

b. Area limit for podiums. For the podiums of structures with residential uses that exceed the base height limit established for the zone under subsection 23.48.010.A.2 and for structures with non-residential uses that exceed a height of 85 feet, the average lot coverage of all the stories below the podium height specified on Map A for 23.48.013 shall not

exceed 75 percent of the lot area, except that 100 percent lot coverage is permitted for each story if the total number of stories below the podium height is three, or fewer, stories, or if the conditions in subsection 23.48.013.B.4.c apply.

c. The area limit on podiums in subsection 23.48.013.B.4.b does not apply if a lot includes one of the following:

- 1) Usable open space that meets the provisions of 23.48.014.G; or
- 2) A structure that has been in existence prior to 1965 and the

following conditions are met;

a) The structure is rehabilitated and maintained to comply with applicable codes and shall have a minimum useful life of at least 50 years from the time that it was included on the lot with the project allowed to waive the podium area limit;

b) The owner agrees that the structure shall not be significantly altered for at least 50 years from the time that it was included on the lot with the project allowed to waive. Significant alteration means the following:

i. Alteration of the exterior facades of the structure, except alterations that restore the facades to their original condition;

ii. Alteration of the floor-to-ceiling height of the street level story, except alterations that restore the floor-to-ceiling height to its original condition; or

iii. The addition of stories to the structure, unless the proposed addition is no taller than the maximum height to which the structure was originally built, or the addition is approved through the design review process as compatible with the original character of the structure and is necessary for adapting the structure to new uses; and

c) If the structure is removed from the lot, then any use of the portion of the lot previously occupied by the structure shall be limited to usable open space.

The portion of the lot previously occupied by the structure shall be defined by a rectangle

enclosing the exterior walls of the structure as they existed at the time it was included on the lot with the project allowed to waive the podium area limit, with the rectangle extended to the nearest street frontage.

d. Additional height for podiums abutting Class 1 Pedestrian Streets.

Podium height for structures fronting on Class 1 Pedestrian Streets pursuant to Section 23.48.014, may exceed podium height limits shown on Map A for 23.48.013 by an average of 5 feet provided that floor-to-ceiling clearance at the ground floor is at least 15 feet.

Map A for 23.48.013 Podium Heights

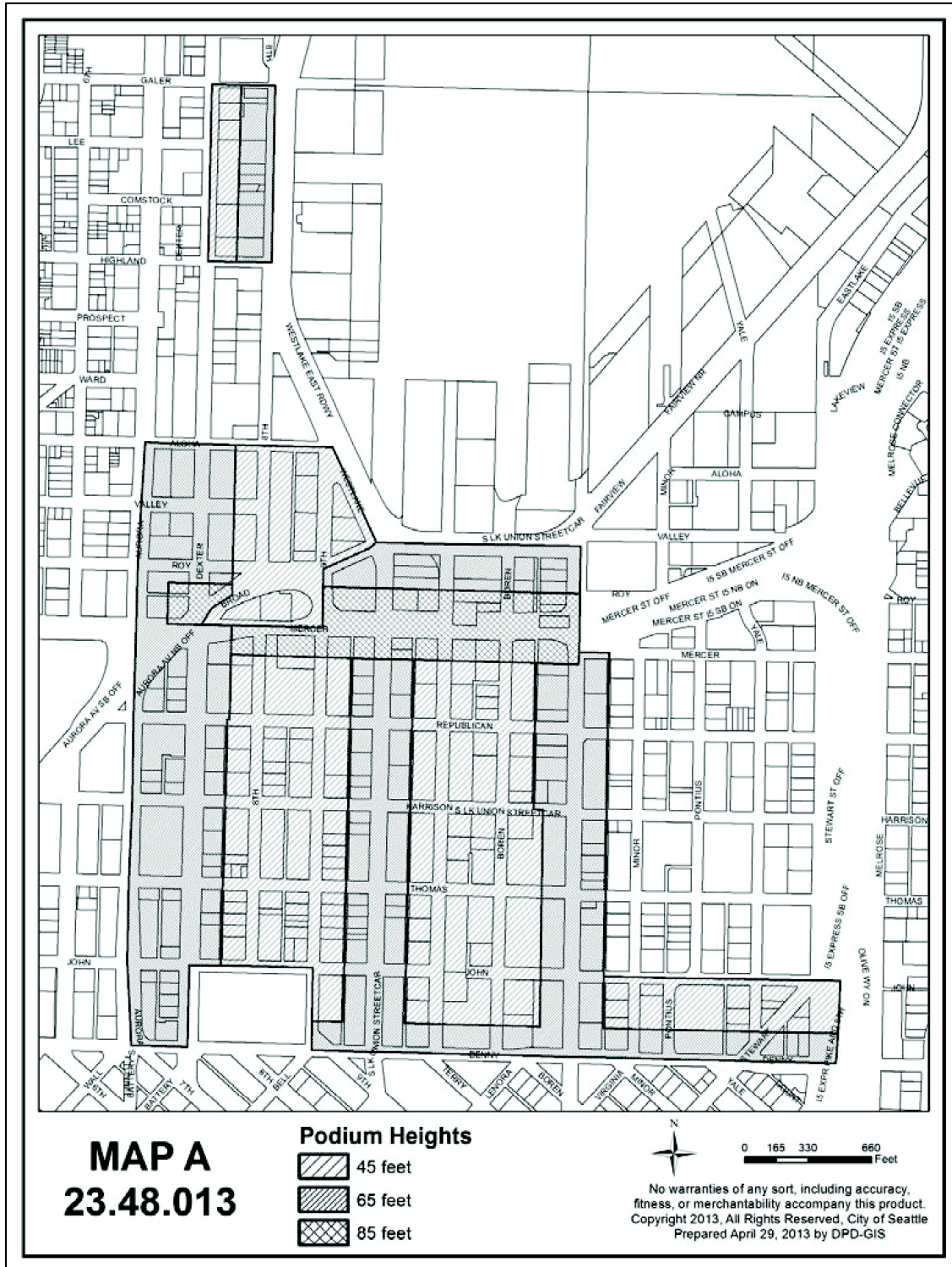

C. Upper-level setbacks

1. The following requirements for upper-level setbacks in this subsection 23.48.013.C.1 apply to development that meets the following conditions:
 - a. The development is on lot abutting a street shown on Map A for 23.48.013; and
 - b. For lots in the SM 85-240, SM 85/65-160, SM 160/85-240, and SM 240/125-400 zones located within the South Lake Union Urban Center, the development includes a tower structure with residential uses exceeding the base height limit established for residential uses in the zone under subsection 23.48.010.A.2, or includes a structure with non-residential uses that exceed a height of 85 feet.
2. The required upper-level setbacks for development specified in subsection 23.48.013.C.1 shall be provided as follows:
 - a. For portions of a structure facing the applicable street, the maximum height above which a setback is required is specified on Column 2 of Table A for 23.48.013.
 - b. For portions of a structure exceeding the maximum height above which a setback is required, the minimum depth of the setback, measured from the abutting applicable street lot line, is specified on Column 3 of Table A for 23.48.013.

Table A for 23.48.013 Required upper-level setbacks for development meeting the conditions of Section 23.48.013.C		
Column 1: Location of lot	Column 2: Height above which setback is required	Column 3: Minimum depth of setback from applicable street property line
Thomas Street, south side, from Aurora Ave N to 8 th Ave N	45 feet	50 feet
Thomas Street, south side, from 8 th Ave N to 9 th Ave N	45 feet	40 feet
Thomas Street, south side, between 9 th Ave N and alley between Fairview Ave N and Minor Ave N	45 feet	30 feet
John Street, north side, between Aurora Ave N and 9 th Ave N	45 feet	30 feet
John Street, north side, between 9 th Ave N and Boren Ave N	45 feet	15 feet
John Street, south side, between Aurora Ave N and Minor Ave N	45 feet	30 feet
Boren Ave N, both sides, between Mercer Street and John Street	65 feet (1)	10 feet (1)
Fairview Ave N, west side, from Mercer Street to John Street	65 feet	10 feet
Fairview Ave N, east side, from Mercer Street to John Street	65 feet	10 feet
Notes to Table A for 23.48.013: (1) On corner lots at intersections with Thomas and John Streets, for the portion of the lot subject to the setback requirements on these cross streets, the lower height above which setbacks are required and the greater distance of the setback from the cross streets apply.		

3. Upper-level setbacks for residential tower development in the SM 85/65-160 zone on the blocks bounded by Valley Street, Mercer Street, Westlake Avenue North, and Fairview Avenue North. For tower structures that include residential use above the base height limit for residential use, or hotel use above a height of 85 feet, upper-level setbacks, in addition to those specified in subsection 23.48.012.B.1, are required as follows:

a. Any portion of the structure above 65 feet in height shall set back a minimum of 30 feet from the following street lot lines:

1) the street lot line abutting the eastern edge of Westlake Avenue North from Mercer Street to Valley Street; and

2) the street lot line abutting the western edge of Fairview Avenue North from Mercer Street to Valley Street.

b. For lots abutting the street lot line on the southern edge of Valley Street between Westlake Avenue North and Fairview Avenue North, any portion of a structure above 65 feet in height shall provide a minimum setback of 25 feet.

4. Upper level setbacks for tower structures in the SM 160/85-240 zone for the block bounded by Mercer Street, Fairview Avenue North, Republican Street, and Boren Avenue North. In addition to upper level setback requirements in this subsection 23.48.013.C, for tower structures with residential or non-residential uses on lots in the SM 160/85-240 zone on the block bounded by Mercer Street, Fairview Avenue North, Republican Street, and Boren Avenue North, any portion of the tower structure above 85 feet shall be set back a minimum of 110 feet from the street lot line abutting Mercer Street.

5. Projections permitted in required upper-level setbacks. The first 4 feet of horizontal projection of decks, balconies with open railings, eaves, cornices, and gutters are permitted in required setbacks, as shown in Exhibit B for 23.48.012.

D. Facade modulation. For all structures with non-residential uses exceeding 85 feet in height, facade modulation is required for the street-facing portions of a structure located within

15 feet of a street lot line and exceeding the podium height specified for the lot on Map A for 23.48.013. No modulation is required for portions of a facade set back 15 feet or more from a street lot line.

1. The maximum length of a facade without modulation is prescribed in Table B for 23.48.013, Façade Modulation. This maximum length shall be measured parallel to each street lot line, and shall apply to any portion of a facade, including projections such as balconies, that is located within 15 feet of street lot lines.

Table B for 23.48.013	
Façade Modulation	
Height of street facing portion of structure	Maximum length of un-modulated façade within 15 feet of street lot line
For stories above the podium height specified on Map A for 23.48.013 up to 125 feet	150 feet
For stories above 125 feet	120 feet

2. If a portion of a facade that is within 15 feet of the street lot line is the maximum length permitted for an un-modulated facade, the length of the façade may be increased only if additional portions of the façade set back a minimum of 15 feet from the street lot line for a minimum distance of 40 feet. If the required setback is provided, additional portions of the façade may be located within 15 feet of the street lot line.

E. Maximum façade width. A maximum façade width applies to certain residential structures that exceed the base height limit for residential use, as specified in subsections 23.48.013.E.1 and 23.48.013.E.2 below. The maximum façade width only applies to portions of the structure above the podium height specified for the lot on Map A for 23.48.013.

1. Except in the SM 85/65-125 zone and the SM 85/65-160 zone on the blocks bounded by Valley Street, Mercer Street, Westlake Avenue North, and Fairview Avenue North,

for portions of a structure that exceed the podium height but do not exceed a height of 160 feet, and that have an average floor size exceeding 10,500 square feet, the maximum façade width is 120 feet along the general east/west axis of the site (perpendicular to the Avenues).

2. In the SM 85/65-125 zone, the maximum façade width is 105 feet along the general north/south axis of the site (parallel to the Avenues).

3. In the SM 85/65-160 zone, on the blocks bounded by Valley Street, Mercer Street, Westlake Avenue North, and Fairview Avenue North, the maximum façade width for portions of structures above the podium height is 105 feet along the general east/west axis of the site (perpendicular to the Avenues).

F. Limit on tower structures per block. The number of towers permitted on a block, which for the purposes of this subsection 23.48.013.F is defined as the area bounded by street lot lines, shall be as follows:

1. Only one residential tower, or one structure with nonresidential uses exceeding 85 feet in height, is permitted on a single block front, except as further limited by subsections 23.48.013.F.3, 23.48.013.F.4, and 23.48.013.F.5.

2. For purposes of this subsection 23.48.013.F an existing tower is either:

a. A tower that is physically present, except as provided below in subsection 23.48.13.F.2.b; or

b. A proposed tower for which a Master Use Permit decision has been issued, unless and until either:

1) the Master Use Permit issued pursuant to such a decision expires or is cancelled, or the related application is withdrawn by the applicant, without the tower having been constructed; or

2) a ruling by a hearing examiner or court reversing or vacating such a decision, or determining such decision or the Master Use Permit issued thereunder to be invalid, becomes final and no longer subject to judicial review.

3. In the SM 85/65-160 zone, only one residential tower structure or one non-residential tower structure with a hotel use meeting residential development standards is permitted per block.

4. In the SM 85/65-125 zone, more than one residential tower is permitted on a block front provided that the minimum lot area for a tower is 30,000 square feet.

5. Only one structure with nonresidential uses exceeding 85 feet in height is permitted on a block, unless the structure is permitted under Section 23.48.017 or unless all of the following conditions apply:

a. The structure is on a lot with a minimum area of 60,000 square feet. The area of one or more lots, separated only by an alley, may be combined for the purposes of calculating the minimum required lot area under this subsection 23.48.013.F.5. The minimum lot area is 59,000 square feet if the lot area was reduced below 60,000 square feet as a result of acquisition of right-of-way by the City;

b. A minimum separation of 60 feet is provided between all portions of structures on the lot that exceed the limit on podium height shown on Map A for 23.48.013. If the lot includes a qualifying Landmark structure, an average separation of 60 feet is permitted.

c. A minimum of 15 percent of the lot area is provided as landscaped open space at ground level, allowing for some area to be provided above grade to adapt to topographic conditions, provided that such open space is accessible to people with disabilities. The required open space shall have a minimum horizontal dimension of 15 feet and shall be provided as one continuous area.

d. A pedestrian connection meeting the development standards of subsection 23.48.014.F for through-block pedestrian connections for large lot developments is provided through the lot to connect the north-south avenues abutting the lot. If the lot abuts an avenue that has been vacated, the connection shall be to an easement providing public access

along the original alignment of the avenue. In addition, if the slope of the lot between the north-south avenues exceeds a slope of 10 percent, a hill-climb shall be provided.

e. The application of the provisions in this subsection 23.48.013.F.5 shall not result in more than two structures on a block with either nonresidential uses above 85 feet in height or with residential use above the base height limit for residential use, except as allowed by subsection 23.48.013.F.5.f.

f. For lots that, as a result of a street vacation, exceed 150,000 square feet, the Director shall, as a Type 1 decision, determine the permitted number of structures with non-residential uses above 85 feet in height or with residential use above the base height limit, based on the limits in subsection 23.48.013.F.5.e as applied to the block conditions existing prior to the street vacation.

g. The Director shall make a determination of project impacts on the need for pedestrian and bike facilities and complete a voluntary agreement between the property owner and the City to mitigate impacts, if any. The Director may consider the following as impact mitigation:

1) Pedestrian walkways on a lot, including through-block connections on through lots, where appropriate, to facilitate pedestrian circulation by connecting structures to each other and abutting streets;

2) Sidewalk improvements, including sidewalk widening, to accommodate increased pedestrian volumes and streetscape improvements that will enhance pedestrian comfort and safety;

3) Improvements to enhance the pedestrian environment, such as providing overhead weather protection, landscaping, and other streetscape improvements; and

4) Bike share stations.

h. For development that exceeds 85,000 or more square feet of gross office floor area, the Director shall make a determination as to the project's impact on the need

for open space. The Director may limit floor area or allow floor area subject to conditions, which may include a voluntary agreement between the property owner and the City to mitigate impacts, if any. The Director shall take into account subsection 23.49.016.A in assessing the demand for open space generated by an office development in an area permitting high employment densities.

1) The Director may consider the following as mitigation for open space impacts:

a) Open space provided on-site or off-site, consistent with the provisions in subsection 23.49.016.C, or provided through payment in lieu, consistent with subsection 23.49.016.D, except that in all cases the open space shall be located on a lot in an SM zone that is accessible to the development's occupants,

b) Additional pedestrian amenities through on-site or streetscape improvements provided as mitigation for impacts on pedestrian facilities pursuant to subsection 23.48.013.F.3.g., and

c) Public space inside or on the roof of a landmark building.

2) The Director may approve open space in lieu of that contained or referred to in subsection 23.49.016.C to mitigate project impacts, based on consideration of relevant factors, including the following:

a) the density or other characteristics of the workers anticipated to occupy the development compared to the presumed office employment population providing the basis for the open space standards applicable under Section 23.49.016; and

b) characteristics or features of the development that mitigate the anticipated open space impacts of workers or others using or occupying the project.

G. Tower separation. The following separation is required between structures with residential use above the base height limit for residential use and that are located on the same

block. For the purposes of this subsection 23.48.013.F, a block is defined as the area bounded by street lot lines.

1. A separation of 60 feet is required between all portions of the structure that exceed the base height limit for residential use, except as exempted by subsection 23.48.013.F.2.

2. No separation is required on blocks within the area bounded by Aurora Avenue North, John Street, Thomas Street and 9th Avenue North.

3. The projection of unenclosed decks and balconies, and architectural features such as cornices shall be disregarded in calculating tower separation.

23.48.014 Street-level development standards

A. General façade requirements

1. Primary pedestrian entrance. Each new structure facing a street is required to provide a primary building entrance for pedestrians from the street or a street-oriented courtyard that is no more than 3 feet above or below the sidewalk grade.

2. Minimum facade height. A minimum façade height is required for the street-facing facades of new structures, unless all portions of the structure are lower than the required minimum facade height listed below.

a. On Class 1 Pedestrian Streets, as shown on Map A for 23.48.014, the minimum height for street-facing façades is 45 feet.

b. On Class 2 Pedestrian Streets and Neighborhood Green Streets, as shown on Maps A and B for 23.48.014, the minimum height for street-facing facades is 25 feet.

c. On all other streets, the minimum height for street-facing facades is 15 feet.

3. Permitted setbacks from street lot lines. Except on lots subject to the provisions of subsection 23.48.014.B, the street-facing facades of a structure are permitted to set back from the street lot line as follows:

a. The street-facing facades of structures abutting Class 1 Pedestrian Streets, as shown on Map A for 23.48.014, shall be built to the street lot line for a minimum of 70 percent of the facade length, provided that the street frontage of any required outdoor amenity area, or other required open space, or usable open space provided in accordance with subsections 23.48.013.B.4.c, 23.48.014.F, or 23.48.014.G is excluded from the total amount of frontage required to be built to the street lot line.

**Exhibit A for 23.48.014
Percentage of Facade at Lot Line**

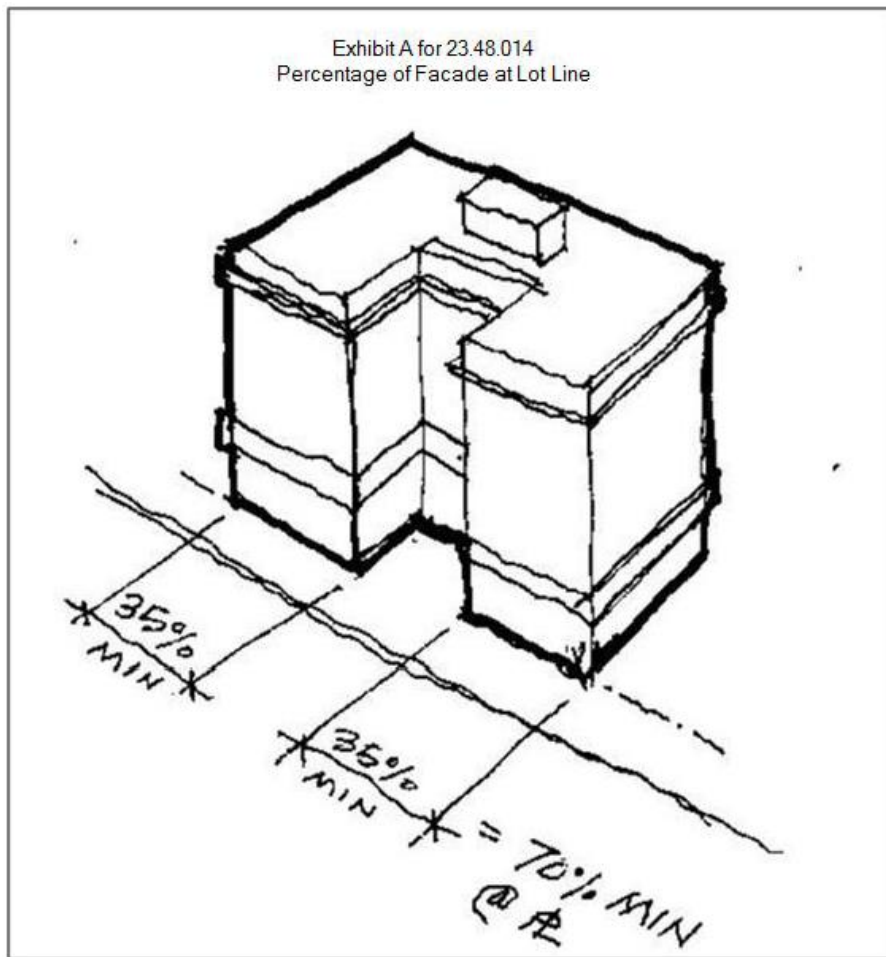

Map A for 23.48.014 Pedestrian Street Classifications in South Lake Union

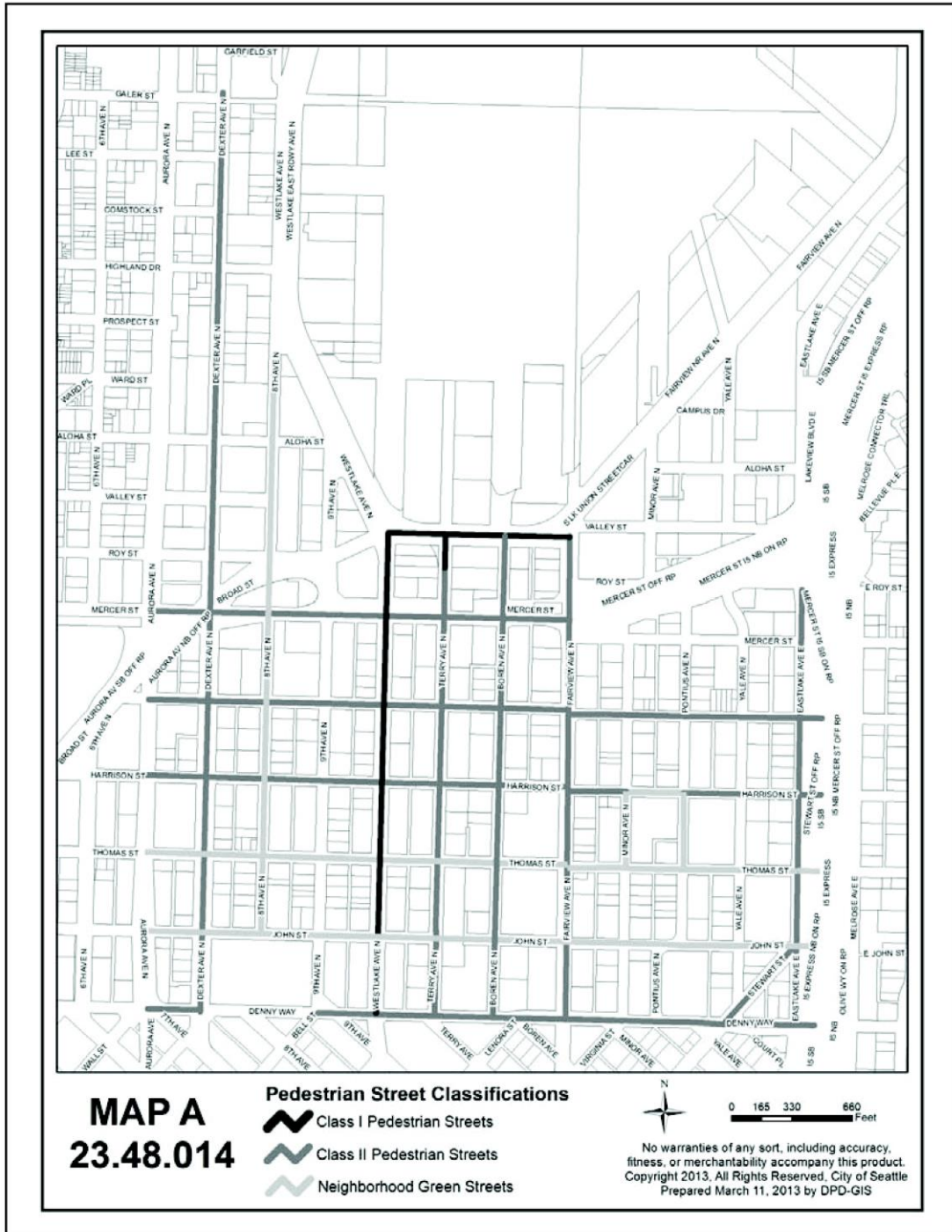

Map B for 23.48.014 Pedestrian Street Classifications in North Rainier

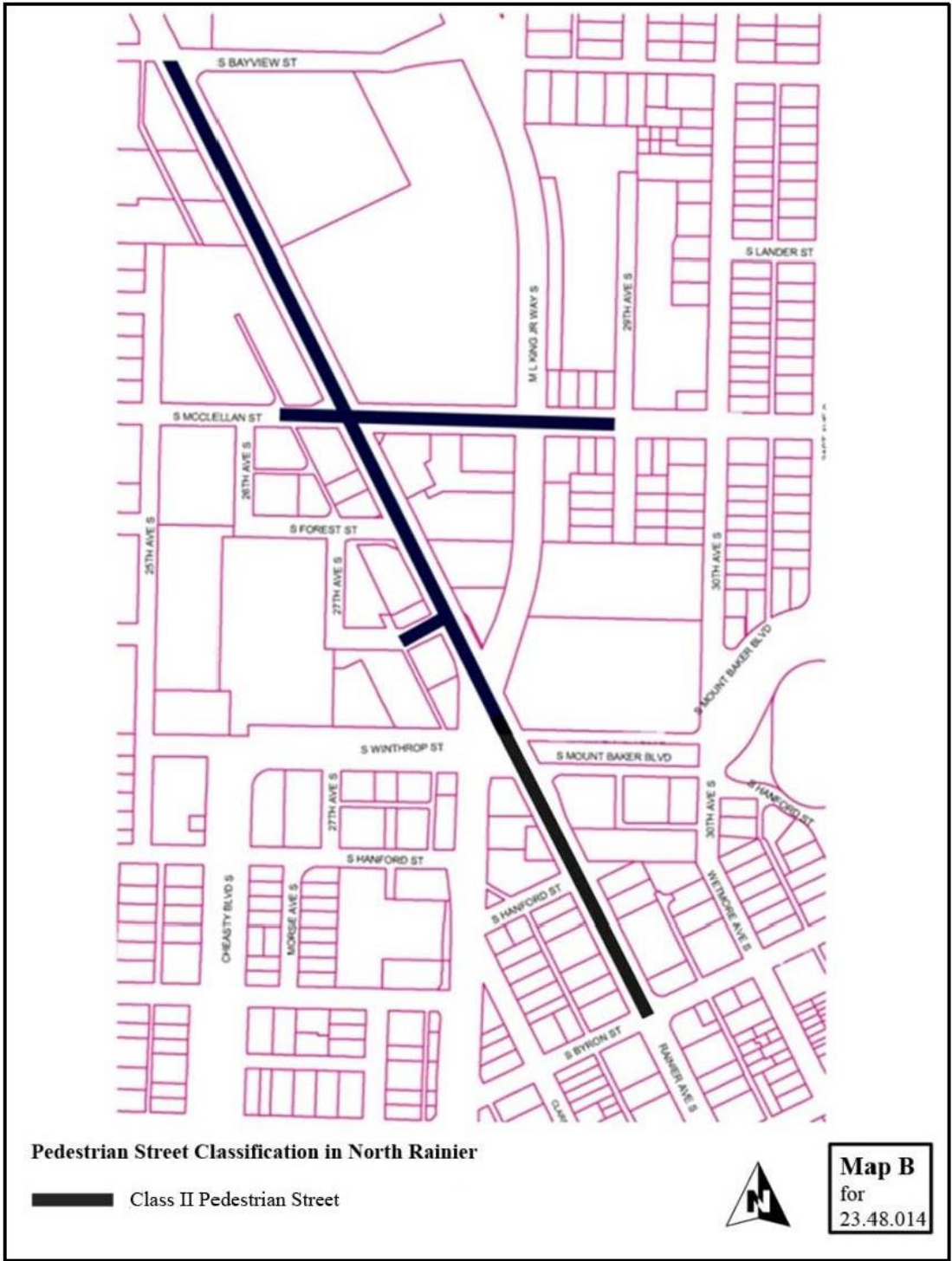

b. Except on Class 1 Pedestrian Streets, as shown on Map A for 23.48.014, and as specified in subsection 23.48.014.B.1, the street-facing façade of a structure may be set back up to 12 feet from the street lot line subject to the following (Exhibit B for 23.48.014):

- 1) The setback area shall be landscaped according to the provisions of Section 23.48.024;
- 2) Additional setbacks are permitted for up to 30 percent of the length of portions of the street façade that are set back from the street lot line, provided that the additional setback is located 20 feet or more from any street corner; and
- 3) Any required outdoor amenity area, or other required open space, or usable open space provided in accordance with subsections 23.49.013.B.4.c, 23.48.014.F or 23.48.014.G is not considered part of the setback area and may extend beyond the limit on setbacks from the street lot line that would otherwise apply under subsections 23.48.014.A.3.b or 23.49.014.A.3.b.2.

Exhibit B for 23.48.014

Street level setback

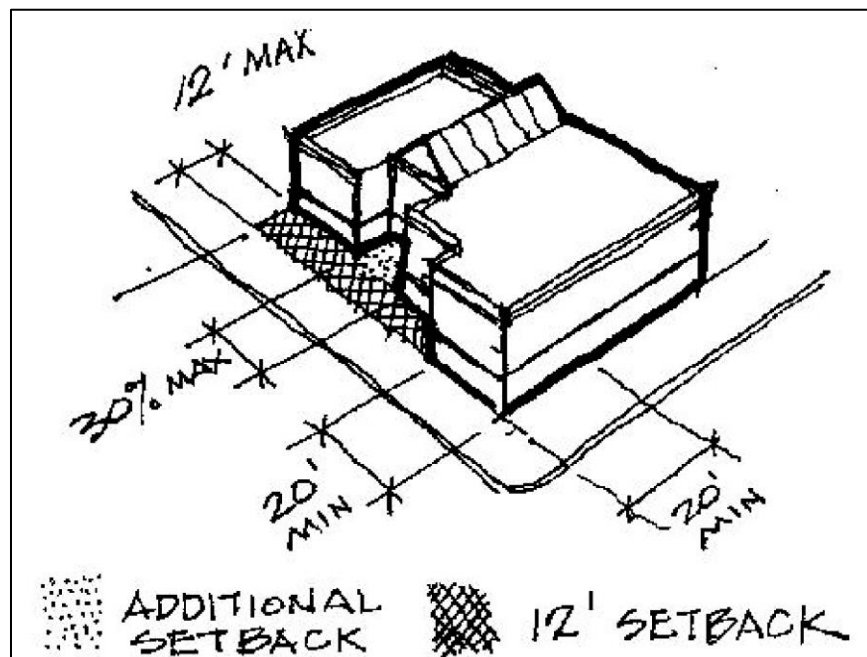

B. Additional façade requirements in the SM 85-240 zone. In addition to the provisions of subsection 23.48.014.A, the following standards apply in the SM 85-240 zone.

1. Required street-facing façade setback

a. All street-facing facades along 8th Avenue North, except those portions occupied by permitted non-residential uses and subject to the provisions of subsection 23.48.014.B.2, are required to set back an average of 10 feet from the street lot line, provided that no setback shall be less than 5 feet from the street lot line, and any setback area further than 15 feet from the street lot line shall not be included in the averaging calculation.

b. The setback requirement of this subsection 23.48.014.B.1 does not apply to the following:

1) Portions of the street-facing façade that are located no more than 40 feet from a street corner; and

2) Portions of the structure that are partially below grade and meet the following conditions:

a) The roof of the partially below-grade portion of the structure in the setback area is no more than 4 feet above finished grade;

b) The surface of the roof is used for private access or amenity area for abutting units; and

c) A landscaped area a minimum of 2 feet in depth measured from the abutting street lot line is maintained at grade level. As a Type I decision, the Director, in consultation with the Director of Transportation, may waive this requirement for a landscaped setback if it is determined that a continuous landscaped area can be provided in the right-of-way area abutting the street lot line.

c. Only ground-related residential units and floor area for building lobbies for residential uses are permitted within the portion of the story of the structure abutting the

required setback area, and each unit or lobby area is required to have direct access to the required setback area.

d. The street-level façade of lobby area abutting the required setback shall not exceed a width equivalent to 20 percent of the total width of the required setback measured along 8th Avenue North.

e. Private amenity area, unenclosed stoops, steps, or porches related to the abutting, ground level residential units or common amenity area with access to residential lobbies shall be provided within the required setback area.

f. Bay windows, canopies, horizontal projection of decks, balconies with open railings, eaves, cornices, gutters, and other similar architectural features are permitted to extend no more than 4 feet into required setbacks.

g. Driveways providing access to parking within a structure are not permitted within the required setback area.

2. Development standards for non-residential uses. Nonresidential uses are permitted on the ground floor of mixed use structures, subject to the following:

a. Non-residential uses are not permitted to extend more than 20 feet above the street level.

b. Non-residential uses are only permitted on corner portions of the lot that are within 20 lineal feet of intersecting street lot lines.

C. Additional requirements in the SM 85/65-160 zone on the blocks bounded by Valley Street, Mercer Street, Westlake Avenue North, and Fairview Avenue North. Street level facades on that portion of Terry Avenue between Mercer Street and Valley Street shall be set back an average of 10 feet from the lot line. In addition all street level facades on Valley Street within 50 feet of Terry Avenue shall be set back an average of 50 feet from the lot line.

Exhibit C for 23.48.014
Area where transparency and blank facade
requirements apply to structures

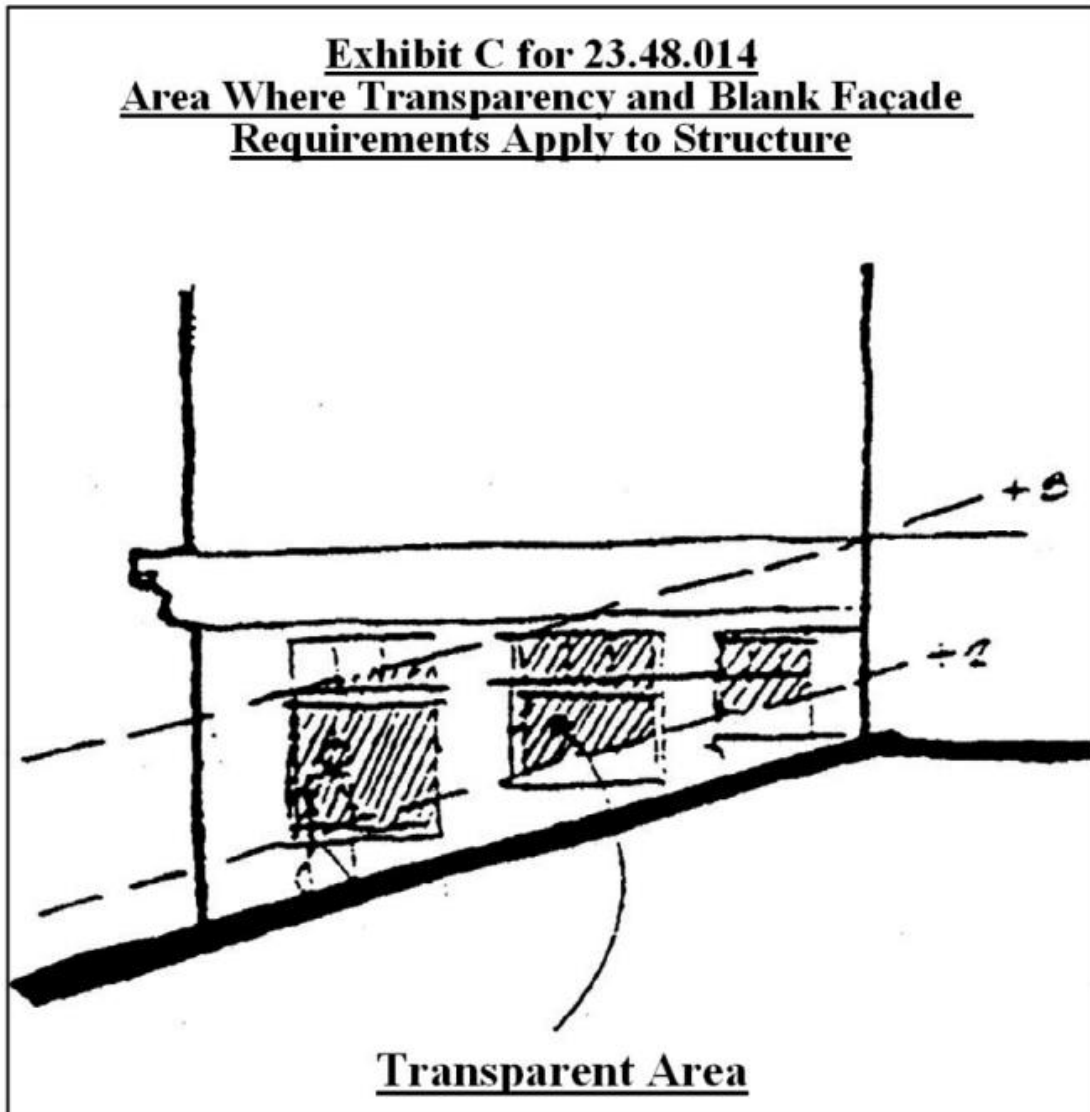

D. Transparency and blank facade requirements. The provisions of this subsection 23.48.014.C apply to the area of a street facing facade between 2 feet and 8 feet above a sidewalk (Exhibit C for 23.48.014).

1. Transparency requirements apply to all street-facing, street level facades, except for portions of structures in residential use, as follow:

a. For Class 1 and Class 2 Pedestrian Streets and Neighborhood Green Streets, shown on Maps A and B for 23.48.014, a minimum of 60 percent of the street facing facade must be transparent.

b. For all other streets not specified in subsection 23.48.014.D.1.a, a minimum of 30 percent of the street facing facade must be transparent.

c. If the slope of the street frontage of the facade exceeds 7.5 percent, the required amount of transparency shall be reduced to 45 percent of the street facing facade on Class 1 and Class 2 Pedestrian Streets and Neighborhood Green Streets, shown on Maps A and B for 23.48.014, and 22 percent of the street facing facade on all other streets.

d. Only clear or lightly tinted glass in windows, doors, and display windows are considered transparent. Transparent areas shall allow views into the structure or into display windows from the outside.

2. Blank facade limits. Any portion of the facade that is not transparent is considered to be a blank facade.

a. Blank facade limits for Class 1 and Class 2 Pedestrian Streets and Neighborhood Green Streets.

1) Blank facades shall be limited to segments 15 feet wide, except for garage doors, which may be wider than 15 feet. Blank facade width may be increased to 30 feet if the Director determines that the facade is enhanced by architectural detailing, artwork, landscaping, or other similar features that have visual interest. The width of garage doors shall be limited to the width of the driveway plus 5 feet.

2) Any blank segments of the facade shall be separated by transparent areas at least 2 feet wide.

3) The total of all blank facade segments, including garage doors, shall not exceed 40 percent of the street facade of the structure on each street frontage; or 55 percent if the slope of the street frontage of the facade exceeds 7.5 percent.

b. Blank facade limits for all other streets not specified in subsection 23.48.014.B.2.a.

1) Blank facades are limited to segments 30 feet wide, except for garage doors which may be wider than 30 feet. Blank facade width may be increased to 60 feet if the Director determines that the facade is enhanced by architectural detailing, artwork, landscaping, or other similar features that have visual interest. The width of garage doors shall be limited to the width of the driveway plus 5 feet.

2) Any blank segments of the facade shall be separated by transparent areas at least 2 feet wide.

3) The total of all blank facade segments, including garage doors, shall not exceed 70 percent of the street facade of the structure on each street frontage; or 78 percent if the slope of the street frontage of the facade exceeds 7.5 percent.

c. Blank facade limits do not apply to portions of structures in residential use.

E. Development standards for required street-level uses. Street-level uses required by subsection 23.48.004.D, and street-level uses exempt from FAR calculations under the provisions of subsection 23.48.009.D.6, whether required or not, shall meet the following development standards:

1. A minimum of 75 percent of each street frontage where street-level uses are required shall be occupied by uses listed in subsection 23.48.004.D. For structures with a street-facing facade along 8th Avenue N., located on blocks identified pursuant to subsection 23.48.017.B, or located on a designated neighborhood green street the minimum street frontage of required street-level uses is 10 percent of that street-facing facade. The remaining street

frontage at street-level may contain other permitted uses and/or pedestrian or vehicular entrances. The frontage of any outdoor common amenity area required for residential uses or other required open space shall not be counted in street frontage.

2. The space occupied by required street-level uses shall have a minimum floor-to-floor height of 13 feet and extend at least 30 feet in depth at street-level from the street front facade.

3. Required street-level uses shall be located within 10 feet of the street lot line, except that if outdoor amenity area required in subsection 23.48.020.B, or other required open space, abuts the applicable street lot line and separates the street-facing façade from the street, the required street-level use may abut the amenity area or open space.

4. Pedestrian access to required street-level uses shall be provided directly from the street, permitted outdoor common amenity area, or abutting required open space. Pedestrian entrances shall be located no more than 3 feet above or below sidewalk grade or at the same elevation as the abutting permitted outdoor common amenity area or required open space.

F. Required open area in the SM 85/65-160 zone. In the SM 85/65-160 zone on the blocks bounded by Valley Street, Mercer Street, Westlake Avenue North, and Fairview Avenue North, a minimum of 20 percent of the lot area shall be provided as open area that is located and configured to allow easy pedestrian access to project occupants from streets or other abutting public spaces, including access for persons with disabilities. The open area shall include the following:

1. A minimum of 60 percent of the required open area shall be provided as usable open space that meets the following conditions:

a. The usable open space is open from the ground to the sky and is visible and accessible to pedestrians from an abutting street, including persons with disabilities;

b. The open space is substantially at street-level, although portions are permitted to be within 4 feet of street level, provided that grade changes are gradual and do not

significantly disrupt the continuity of the space, and no part of the open space is significantly above or below the grade of the nearest abutting street;

c. The open space has a minimum horizontal dimension of 15 feet; and

d. The open space enhances visual and physical pedestrian connections between South Lake Union Park and development on the lot, and is accessible to the public, free of charge, during the hours of operation of South Lake Union Park.

2. At the applicant's option, up to 40 percent of the required open area may be provided as any combination of:

a. A woonerf that serves as a through-block pedestrian passageway and that satisfies the following:

1) The passageway is open to the sky, has a minimum width of 20 feet, and provides a direct and continuous connection between the north/south avenues abutting the lot;

2) The passageway is designed to provide safe pedestrian use, including a clear pathway demarcated as a priority pedestrian zone; and

3) The passageway is adequately lit and available for pedestrian use 24 hours every day

b. Open areas with a horizontal dimension that is less than 15 feet abutting a street lot line if one or more of the following:

1) An area abutting a sidewalk that extends the pedestrian area onto the lot to accommodate additional streetscape amenities, such as landscaping, street furniture, special lighting, public art, or extensions of right-of-way green factor treatments;

2) Setback areas abutting the street with a maximum depth of 10 feet that provide private usable open space, stoops, terraces, and/or landscaping for abutting ground level dwelling units that have direct access to the setback area, provided that the total

amount of such setback areas does not exceed half of the 40 percent portion of the open area allowed by this subsection 23.48.014.F.2; or

3) Additional sidewalk areas created by extending the curbline into the abutting street right-of-way that are improved with such streetscape amenities as landscaping, street furniture, special lighting, public art, or extensions of right-of-way green factor treatments.

c. Usable elevated open space up to a maximum of 40 feet above street-level, and that meets the following:

1) At least 50 percent of the perimeter of the elevated open space is not enclosed by a façade and is open and oriented to provide views of South Lake Union Park;

2) The minimum horizontal dimension of the open space is 15 feet, and

d. No more than 50 percent of the open areas allowed pursuant to this subsection 23.48.014.F.2 shall be:

1) Located more than 4 feet above street-level.; and

2) Comprised of unenclosed covered areas, such as arcades or areas beneath building overhangs or overhead weather protection attached to abutting facades that abut sidewalks or pedestrian paths across the lot, or freestanding pavilions or kiosks that provide overhead weather protection..

3. When authorized by the Director as a Type I decision pursuant to this subsection 23.49.014.F, lots within the SM 85/65-160 zone on the blocks bounded by Valley Street, Mercer Street, Westlake Avenue North, and Fairview Avenue North, may be combined, whether contiguous or not, for the purpose of allowing the open area required on a lot by this subsection 23.48.014.F to be met on one or more other lots within the SM 85/65-160 zone on the blocks bounded by Valley Street, Mercer Street, Westlake Avenue North, and Fairview Avenue North, according to the following provisions:

a. The Director shall allow lots to be combined to meet open area requirements if the Director determines that the combined amount of open area on all lots meets or exceeds the minimum amount required by subsection 23.48.014.F.1, and that the added flexibility will achieve better open space conditions, as indicated by the following:

1) The open area in general will provide for a better relationship between the development on the combined lots and South Lake Union Park;

2) The added flexibility will allow for better integration of open space and surrounding development and improve accessibility among the blocks in the SM 85/65-160 zone on the blocks bounded by Valley Street, Mercer Street, Westlake Avenue North, and Fairview Avenue North and adjacent areas;

3) A greater diversity of open space will be achieved for the area;

4) Greater public use of the open space will be encouraged;

5) The flexibility would result in open spaces that are more substantial in size and/or more adaptable to a greater variety of uses, or that establish a more significant neighborhood focal point than would otherwise likely occur; and/or

6) The open space provided will enhance urban form by promoting better massing, more usable open spaces with increased solar access, enhanced views within and through the site, and other improved conditions.

b. Prior to issuance of a Master Use Permit for any development that relies on one or more other lots within the SM 85/65-160 zone on the blocks bounded by Valley Street, Mercer Street, Westlake Avenue North, and Fairview Avenue North to meet the open area requirements of this subsection 23.48.014.F, the fee owners of both the property subject to the Master Use Permit and the lot(s) utilized to meet open area requirements for the Master Use Permit shall execute an appropriate agreement or instrument that is recorded in the King County real property records that:

1) Includes the legal description of each lot;

2) Acknowledges the specific extent to which the open space standards are met through a combination of the lots;

3) Provides that its covenants and conditions shall run with the land and shall be specifically enforceable by the parties and by the City of Seattle; and

4) Provides that the agreement or instrument shall be in effect unless the Master Use Permit expires, is cancelled, is withdrawn by the applicant, or the development allowed by the Master Use Permit no longer requires the other lot(s) in order to meet the open area requirements of this subsection 23.48.014.F.

G. Required usable open space in the SM 85/65-125, SM 85/65-160, SM 160/85-240 and SM 240/125-400 zones.

1. Except as provided for in subsection 23.48.014.G.3 and 23.48.014.G.4, in the SM 85/65-125, SM 85/65-160, SM 160/85-240 and SM 240/125-400 zones, on lots exceeding 30,000 square feet in area, proposed development containing extra floor area as provided for in Section 23.48.011 shall provide usable open space as follows:

a. The minimum amount of required usable open space shall be equal to 15 percent of the lot area and shall generally be accessible at street level, with variations in elevation allowed to accommodate changes in topography;

b. The average horizontal dimension for any area qualifying as required usable open space is 20 feet, and the minimum horizontal dimension is 10 feet, except that there is no minimum horizontal dimension for additional pedestrian area abutting a sidewalk that is provided according to subsection 23.48.014.G.1.f;

c. A minimum of 45 percent of the required usable open space shall be exterior space open to the sky and shall abut a street along at least one street frontage and provide both visual and physical access from the street to pedestrians, including persons with disabilities;

d. Up to a maximum of 20 percent of the required usable open space may be covered overhead to provide weather protected space and a widened sidewalk area, if the following conditions are met:

1) The open space abuts a street lot line and is open and accessible to pedestrians along the sidewalk and,

2) If the space is covered by portions of the structure above, or is provided as an arcade open to the street, the minimum vertical clearance is 20 feet;

e. Up to a maximum of 35 percent of the required usable open space may be provided as enclosed space, such as a public atrium, a shopping atrium, wintergarden, or covered portion of a through-block pedestrian connection, if the enclosed open space meets all of the following requirements:

1) Direct access is provided to pedestrians, including persons with disabilities, from the street, or from an outdoor, usable public open space abutting the street;

2) The space is provided as one continuous area that is a minimum of 2,000 square feet in size. Space, such as lobby area, that is used solely to provide access between the structure's principal street entrance and elevators, does not qualify as required usable open space;

3) The minimum floor-to-ceiling height is 15 feet;

4) The space is accessible to the public during normal business hours; and

f. Up to a maximum of 10 percent of the required usable open space may be provided as an area abutting a sidewalk that extends the pedestrian area onto the lot or accommodates landscaping or extensions of right-of way green factor treatment pursuant to Section 23.86.019. Minor changes between the sidewalk elevation and the elevation of the abutting sidewalk area are permitted to accommodate changes in topography, or to provide for features such as ramps that improve access for persons with disabilities.

2. Usable open space provided under this subsection 23.48.014.G is eligible to qualify as amenity area for residential uses under Section 23.48.020 or open space required for office use under Section 23.48.022, provided the applicable standards of these Sections are met.

3. Usable open space satisfying the requirements of this subsection 23.48.014.G may be provided on a site other than the project site, provided that the following conditions are met:

a. The alternate open space site is located within an SM zone and within 650 feet of the project site;

b. The amount of usable open space is no less than 10 percent of the lot area; and

c. The owner of any lot on which off-site open space is provided records a restrictive covenant in a form acceptable to the Director assuring compliance with requirements of this subsection 23.48.014.G.

H. Through-block pedestrian connections for large lot developments

1. A through-block pedestrian connection meeting the standards of subsection 23.48.014.G.2 is required in the SM 85/65-125, SM 85-240, SM 85/65-160, SM 160/85-240, and SM 240/125-400 zones for development described as follows:

a. Within the block defined as the area enclosed by street rights-of-way, the lot area of the development is a minimum of 60,000 square feet, except that the area of lots separated only by an alley right-of-way may be combined for the purposes of calculating the minimum required lot area;

b. The lot area of the development abuts the two north-south avenues for a minimum linear distance of 120 feet along each avenue.

2. The required through-block pedestrian connection shall meet the following development standards:

a. A continuous pedestrian passageway shall extend across the development lot to both abutting avenues. The alignment of the pedestrian connection and the point at which it intersects each avenue shall be no closer than 100 feet to an east-west street abutting the block, and the connection at the avenues shall be accessible at grade level from the sidewalk.

b. The required pedestrian connection shall have an average width of 25 feet and a minimum width of 15 feet. Any segment of the pedestrian passage that is covered from side to side shall have a minimum width of 20 feet.

c. The pedestrian passage shall be open to the sky, except that up to 35 percent of the length of the passageway may be covered and enclosed, provided the minimum height of covered portions is 13 feet. Unenclosed area of the pedestrian connection may be counted as required open space; and

d. If the pedestrian passage crosses an alley, the alley right-of-way shall be improved to ensure pedestrian safety and to reinforce the relationship between portions of the passageway on either side of the alley.

3. The Director may allow departures from the standards for through-block pedestrian connections as a Type I decision, if the applicant demonstrates that alternative treatments will better serve the development by enhancing pedestrian comfort and promoting greater use of the connection.

4. For development providing a through-block pedestrian connection on blocks with an alley, the allowed FAR from any lot included in the development may be transferred to any other lot of the development across the alley.

23.48.017 Additional height in certain SM-zoned areas in the South Lake Union Urban Center

A. Applicability and general provisions. For structures in the SM 160/85-240 zone designed for research and development laboratory use and administrative office associated with

research and development laboratories, structures that do not exceed a height of 120 feet are not subject to the floor area limits of subsection 23.48.013.B, provided the project complies with all the requirements of this Section 23.48.017. In order for a structure to qualify for the exemption from the floor area limit, at least one complete MUP application for a structure on the same block that has been permitted to extend up to a height of 120 feet without floor area limits shall be filed within nine months of February 17, 2010.

B. Location. A structure may be exempt from floor area limits of subsection 23.48.013.B if the structure:

1. is located on a block that is designated SM 160/85-240;
2. is bounded by arterial-designated streets on at least two sides;
3. is greater than 60,000 square feet in size and does not exceed 100,000 square feet in size; and
4. is not bisected by an alley or other public right-of-way.

C. Street-level uses. Street-level uses shall be provided as required by subsection 23.48.004.D.3.

D. LEED requirement. The applicant will strive to achieve a LEED Gold rating or better and at a minimum earn a LEED Silver rating or meet a substantially equivalent standard, and shall demonstrate compliance with that commitment, all in accordance with the provisions of Section 23.48.025.

E. Open space. A minimum of 20 percent of the lot area shall be useable open space. The purpose of the open space shall be to allow for public seating, passive recreation, and a mid-block pedestrian connection. For a multi-phase project, the open space requirement and the other requirements in this subsection 23.48.017.E shall be calculated and applied to the total project. The following standards apply to open space required under this subsection 23.48.017.E:

1. The open space shall be open during daylight hours and accessible to the general public, without charge, for a minimum of ten hours per day, except that access may be

temporarily limited as required for public safety, security, scheduled events, or maintenance reasons. Members of the public may not be asked to leave for any reason other than conduct that unreasonably interferes with the enjoyment of the space by others, unless the space is closed to the general public consistent with this subsection 23.48.017.E.1. No parking, storage or other use may be established on or above the surface of the open space except as provided in this subsection 23.48.017.E. Use of the open space by motor vehicles is prohibited. The open space shall be clearly identified with signage placed at a visible location at each street entrance providing access to the open space. The signage shall indicate, in letters legible to passersby, the nature of the open space, its availability for general public access, and directional information as needed.

2. The open space shall contain at least one contiguous area with a minimum of 3,000 square feet and a minimum horizontal dimension of 10 feet.
3. A minimum of 35 percent of the open space shall be landscaped with grass, ground cover, bushes and/or trees.
4. Either permanent or movable seating in an amount equivalent to one lineal foot for every 200 square feet of open space shall be available during hours of public access.
5. The open space shall be located and configured to provide easy access from streets or other abutting public spaces and convenient pedestrian circulation through the open space. The open space shall have a minimum frontage of 30 feet at grade abutting a sidewalk, and be visible from sidewalks on at least one street.
6. The open space shall be provided at ground level, except that some separation of multiple levels may be allowed, provided they are physically and visually connected.
7. Up to 20 percent of the open space may be covered by features accessory to public use of the open space, including: permanent, freestanding structures, such as retail kiosks, pavilions, or pedestrian shelters; structural overhangs; overhead arcades or other forms of overhead weather protection; and any other features approved by the Director that contribute to

pedestrian comfort and active use of the space. The following features within the open space area may count as open space: areas for temporary kiosks and pavilions, public art, water features, permanent seating that is not reserved for any commercial use, exterior stairs and mechanical assists that provide access to the open space and are available for public use, and any similar features approved by the Director. Seating or tables, or both, may be provided and reserved for customers of restaurants or other uses abutting the open space, however, the area reserved for customer seating shall not exceed 15 percent of the open space area or 500 square feet, whichever is less.

8. Public art shall be included in the public open space. The artwork may include but need not be limited to water features, or two or three-dimensional works in all media. The artwork shall be clearly visible to people using the open space, and, wherever possible, should be visible from the abutting streets. The property owner is responsible for maintaining all art features for the life of the buildings on the lot.

F. Transportation Management Program. The Master Use Permit application shall include a Transportation Management Program (TMP) consistent with requirements for TMPs in the applicable Director's Rule. The TMP shall be approved by the Director only if, after consulting with the Director of Transportation, the Director determines that no more than 40 percent of trips to and from the project will be made using single-occupant vehicles (SOVs).

1. For purposes of measuring attainment of SOV goals contained in the TMP, the number of SOV trips shall be calculated for the p.m. hour in which an applicant expects the largest number of vehicle trips to be made by employees at the site (the p.m. peak hour of the generator).

2. Compliance with this Section 23.48.017 does not affect the responsibility of any employer to comply with Seattle's Commute Trip Reduction (CTR) Ordinance.

G. Energy Management Plan. The Master Use Permit application shall include an energy management plan, approved by the General Manager and Chief Executive Officer of Seattle City

Light, containing specific energy conservation or alternative energy generation methods or on-site electrical systems that together can ensure that the existing electrical system can accommodate the projected loads from the project. The Director, after consulting with the Superintendent of Seattle City Light, may condition the approval of the Master Use Permit on the implementation of the energy management plan.

23.48.020 Amenity area for residential uses

A. Amenity area. Amenity area is required for all new development with more than 20 dwelling units.

B. Quantity of amenity area. An area equivalent to 5 percent of the total gross floor area in residential use shall be provided as amenity area, except that, in no instance shall the amount of required amenity area exceed the area of the lot.

C. Standards for amenity area. Required amenity area shall meet the following standards:

1. All residents of the project shall have access to the required amenity area, which may be provided at or above ground level.

2. A maximum of 50 percent of the required amenity area may be enclosed.

3. The minimum horizontal dimension for required amenity areas is 15 feet, except that the minimum horizontal dimension is 10 feet for amenity areas provided as landscaped open space accessible from the street at street-level. The minimum size of a required amenity area is 225 square feet.

4. Amenity area that is provided as landscaped, street-level open space that is accessible from the street shall be counted as twice the actual area in determining the amount provided to meet amenity area requirement.

5. In mixed use projects, the Director may permit a bonused public open space to satisfy a portion of the required amenity area, provided that the space meets the standards of this Section 23.48.020, and the Director finds that its design, location, access and hours of operation meet the needs of building residents.

6. Parking areas, driveways, and pedestrian access, except for pedestrian access meeting the Washington State Rules and Regulations for Barrier Free Design, shall not be counted as amenity area.

7. For a development that maintains a designated Seattle Landmark on the lot, the Director may, as Type I decision, waive or modify the amenity area requirement if it is determined that maintaining the Landmark structure significantly limits the ability to accommodate the required amenity area on the site.

8. For lots abutting a designated neighborhood green street, up to 50 percent of the amenity area requirement may be met by contributing to the development of the abutting green street. The Director may waive the requirement that the green street abut the lot and allow the improvement to be made to a green street located in the general vicinity of the project if the Director determines that the green street will benefit residents of the project.

23.48.022 Open space requirement for office uses

A. Finding. The City Council finds that:

1. With the increase in office development and the Comprehensive Plan's significant employment growth targets for the South Lake Union Urban Center, office workers will increasingly become major users of open space in the area.

2. Additional major office projects in South Lake Union will result in increased use of public open space. If additional major office projects in South Lake Union do not provide open space to offset the additional demands on public open space caused by such projects, the result will be overcrowding of public open space, adversely affecting the public health, safety and welfare.

3. Recent and projected office development in the South Lake Union Urban Center is generally comparable to office development in the abutting Downtown Urban Center in terms of tenant characteristics, density, and open space need. Therefore, the findings that support

the current open space requirement in major Downtown office projects are applicable to conditions in South Lake Union.

4. The additional open space needed to accommodate office workers is at least 20 square feet for each 1,000 square feet of office space.

5. As in Downtown, smaller office developments in South Lake Union may encounter design problems in incorporating open space, and the sizes of open spaces provided for office projects under 85,000 square feet may make them less attractive and less likely to be used. Therefore, and in order not to discourage small scale office development, projects involving less than 85,000 square feet of new office space should be exempt from any open space requirement.

B. Quantity of open space. Open space in the amount of 20 square feet for each 1,000 square feet of gross office floor area is required for the following projects:

1. The project is on a lot located in an SM zone within the South Lake Union Urban Center that has a height limit for nonresidential uses that exceeds 85 feet; and
2. The project includes 85,000 or more square feet of gross office floor area.

C. Standards for open space. Open space may be provided on-site or off-site, as follows:

1. On-site open space

- a. Open space on site or on an adjacent lot directly accessible from the project site shall satisfy the requirement of this Section 23.48.022 if it meets the standards of 23.48.014.G and the open space is accessible to all occupants of the building.

b. Open space provided on-site under this requirement is eligible for amenity feature bonuses, where allowed in Section 23.48.011 when the following standards are met:

- 1) The space has a minimum horizontal dimension of 20 feet and a minimum floor-to-ceiling height of 13 feet;

2) The space is directly accessible to pedestrians, including persons with disabilities, from the street, or from an outdoor usable open space abutting the street;

3) The space is available for use during normal business hours;

4) Enclosed areas providing the connection between the structure's primary pedestrian access to the street and elevator cores, such as lobby space, do not qualify as required open space.

2. Off-site public open space

a. Open space satisfying the requirement of this Section 23.48.022 may be on a site other than the project site, provided that it is within an SM zone and within one-quarter mile of the project site, open to the public without charge, and at least 3,000 square feet in contiguous area. The minimum size of off-site open space and maximum distance from the project may be increased or decreased for a project if the Director determines that such adjustments are reasonably necessary to provide for open space that will meet the additional need for open space caused by the project and enhance public access.

b. Public open space provided on a site other than the project site may qualify for a development bonus for the project if the open space meets the standards of Section 23.48.013.

3. Easement for off-site open space. The owner of any lot on which off-site open space is provided to meet the requirements of this Section 23.48.022 shall execute and record an easement in a form acceptable to the Director assuring compliance with the requirements of this Section 23.48.022. The Director is authorized to accept such an easement, provided that the terms do not impose any costs or obligations on the City.

4. Open space provided under this Section 23.48.022 shall qualify as the open space required under Section 23.48.014.F and 23.48.014.G.

D. Payment in lieu. In lieu of providing open space required under this Section 23.48.022, an owner may make a payment to the City if the Director determines that the payment will contribute to the improvement of a designated green street or to other public open space improvements abutting the lot or in the vicinity, in an amount sufficient to develop improvements that will meet the additional need for open space caused by the project, and that completion of the improvement within a reasonable time is feasible. Any such payment shall be placed in a dedicated fund or account and used within five years of receipt for the development of such improvements, unless the property owner and the City agree upon a different improvement involving the acquisition or development of public open space that will mitigate the impact of the project. A bonus may be allowed for a payment in lieu of providing the improvement made wholly or in part to satisfy the requirements of this Section 23.48.022, pursuant to Section 23.49.013.

E. Limitations. Open space satisfying the requirement of this Section 23.48.022 for any project shall not be used to satisfy the open space requirement for any other project, nor shall any bonus be granted to any project for open space meeting the requirement of this Section 23.48.022 for any other project. When a transmitting antenna is sited or proposed to be sited on a rooftop where required open space is located, see Section 23.57.013. Open space on the site of any building for which a Master Use Permit decision was issued or a complete building permit application was filed prior to the effective date of this ordinance, that was not required under the Land Use Code in effect when such permit decision was issued or such application filed, but that would have been required for the same building by this Section 23.48.022, shall not be used to satisfy the open space requirement or to gain an FAR bonus for any other project.

23.48.024 Screening and landscaping standards

A. Landscaping requirements

1. All landscaping provided to meet the requirements of this Section 23.48.024 shall comply with the Director's rules adopted to foster the long-term health, viability, and

coverage of plantings. The Director's rules shall address, at a minimum, the type and size of plants, spacing of plants, use of drought-tolerant plants, and access to light and air for plants. these rules.

2. Landscaping that achieves a Green Factor score of .30 or greater, pursuant to Section 23.86.019, is required for any lot with:

- a. development containing more than four dwelling units; or
- b. development, either a new structure or an addition to an existing structure, containing more than 4,000 square feet of nonresidential uses; or
- c. any parking lot containing more than 20 new parking spaces for automobiles.

3. Landscaping required by this Section 23.48.024 to achieve the Green Factor score of .30 may be met on one or more other lots within the SM 85/65-160 zone, on the blocks bounded by Valley Street, Mercer Street, Westlake Avenue North, and Fairview Avenue North, or their adjacent rights-of-way when a Green Factor score of .50 or greater is achieved and when, prior to issuance of a Master Use Permit for any development that relies on one or more other lots within the SM 85/65-160 zone, on the blocks bounded by Valley Street, Mercer Street, Westlake Avenue North, and Fairview Avenue North, or their adjacent rights-of-way to meet the landscaping requirement of this section, the fee owner of the lot(s) used to meet landscaping requirements shall execute a restrictive covenant that is recorded in the King County real property records that;

- a. restricts the use of that portion of the off-site property that is to meet the landscaping requirement of this section, to the landscaping required by this section;
- b. includes the legal descriptions of the lot burdened by the covenant;
- c. acknowledges the specific extent to which the Green Factor standards are met through a combination of the lots; and

d. provides that the covenant shall be in effect until the Master Use Permit terminates or the development allowed by the Master Use Permit no longer requires the off-site landscaping.

B. Where screening or landscaping is required for specific uses in subsection 23.48.024.C, the following types of screening and landscaping shall be provided:

1. Three foot high screening on street lot lines. The required screening may be provided as either:

- a. A fence or wall at least 3 feet in height; or
- b. A hedge or landscaped berm at least 3 feet in height.

2. Landscaping for setback areas and berms. Each setback area or berm required shall be planted with trees, shrubs, and grass or evergreen groundcover. Features such as pedestrian access meeting the Washington State Rules and Regulations for Barrier-Free Design, decorative pavers, sculptures or fountains may cover a maximum of 30 percent of each required landscaped area or berm. Landscaping shall be provided according to standards promulgated by the Director. Landscaping designed to provide treatment for storm water runoff qualifies as required landscaping.

C. Screening for specific uses

1. Gas stations shall provide 3 foot high screening along lot lines abutting all streets, except within required sight triangles.

2. Surface parking areas

a. Surface parking areas abutting streets. Surface parking areas shall provide 3 foot high screening along the lot lines abutting all streets, except within required sight triangles.

b. Surface parking areas abutting alleys. Surface parking areas shall provide 3 foot high screening along the lot lines abutting an alley. The Director may reduce or

waive the screening requirement for part or all of the lot line abutting the alley when required parking is provided at the rear lot line and the alley is necessary to provide aisle space.

3. Parking in structures. Except as provided for by subsection 23.48.034.B, parking located at or above street-level in a garage shall be screened according to the following requirements.

a. On Class 1 and 2 Pedestrian Streets, shown on Maps A and B for 23.48.014, parking is not permitted at street level unless separated from the street by other uses, provided that garage doors need not be separated. The facade of the separating uses shall be subject to the transparency and blank facade standards in Section 23.48.014.

**Exhibit A for 23.48.024
Screening for parking at street level (on Class II Pedestrian Streets)**

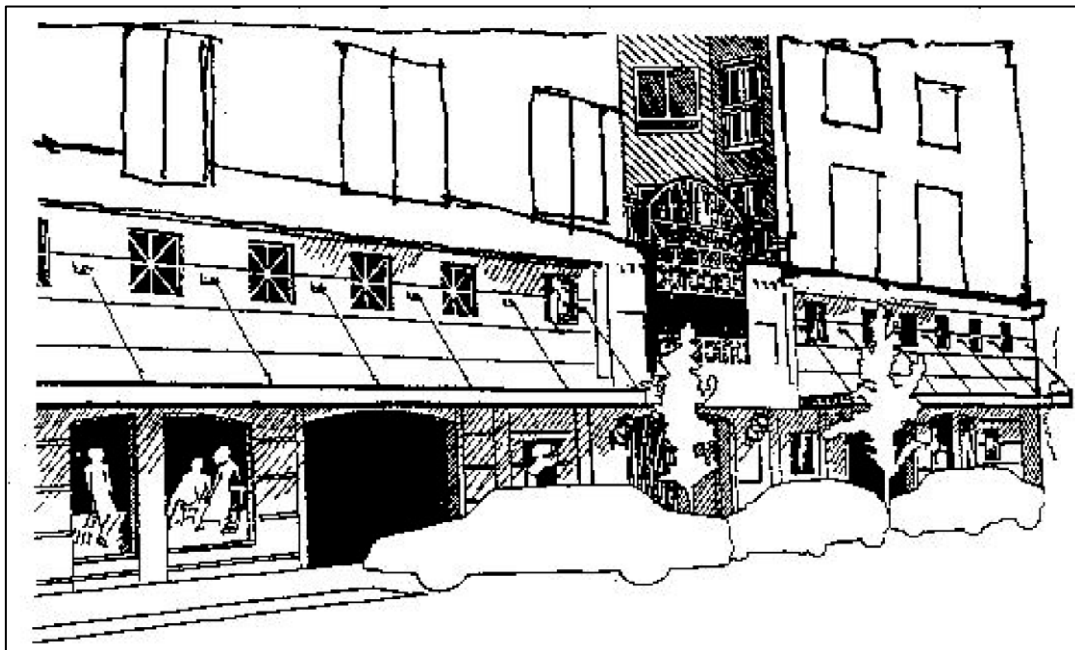

b. On all other streets, parking is permitted at street level when at least 30 percent of the street frontage of the parking area, excluding that portion of the frontage occupied by garage doors, is separated from the street by other uses. The facade of the separating uses

shall be subject to the transparency and blank wall standards in Section 23.48.014. The remaining parking shall be screened from view at street level and the street facade shall be enhanced by architectural detailing, artwork, landscaping, or similar visual interest features (Exhibit A for 23.48.024).

c. The perimeter of each floor of parking above street level shall have an opaque screen at least 3.5 feet high.

4. Fences or free-standing walls associated with utility services uses may obstruct or allow views to the interior of a site. Where site dimensions and site conditions allow, applicants are encouraged to provide both a landscaped setback between the fence or wall and the right-of-way, and a fence or wall that provides visual interest facing the street lot line, through the height, design or construction of the fence or wall, including the use of materials, architectural detailing, artwork, vegetated trellises, decorative fencing, or similar features. Any fence or free-standing wall for a utility service use shall provide either:

a. A landscaped area a minimum of 5 feet in depth between the wall or fence and the street lot line; or

b. Architectural detailing, artwork, vegetated trellises, decorative fencing, or similar features to provide visual interest facing the street lot line, as approved by the Director.

D. Street trees requirements

1. Street trees shall be provided in all planting strips. Existing street trees may count toward meeting the street tree requirement.

2. Exceptions to street tree requirements

a. Street trees are not required when a change of use is the only permit requested.

b. Street trees are not required for temporary use permits.

c. Street trees are not required if an existing structure is expanded by less than 1,000 square feet. Generally, two street trees shall be required for each additional 1,000

square feet of expansion. Rounding of fractions, per subsection 23.86.002.B, is not permitted. The number of street trees shall be controlled by the Seattle Department of Transportation standard.

3. If it is not feasible to plant street trees according to City standards, either a landscaped setback a minimum of 5 feet deep is required along the street lot line, or landscaping other than trees may be located in the planting strip according to Department of Transportation standards. The street trees shall be planted in the landscaped area at least 2 feet from the street lot line if they cannot be placed in the planting strip.

23.48.025 Demonstration of LEED rating

A. Applicability. This Section 23.48.025 applies if a commitment to earn a LEED rating or substantially equivalent standard is a condition of a permit. Applicants for all new development, except additions and alterations, gaining extra residential floor area pursuant to Section 23.48.011, or seeking to qualify for the higher FAR limit in the applicable Table A for 23.48.009 or Table B for 23.48.009, shall make a commitment that the structure will meet Leadership in Energy and Environmental Design (LEED) rating, except that an applicant who is applying for funding from the Washington State Housing Trust Fund and/or the Seattle Office of Housing to develop new affordable housing, as defined in Section 23.58A.180 may elect to meet green building performance standards by meeting the Washington Evergreen Sustainable Development Standards (ESDS).

B. The Director is authorized to determine, as a Type I decision, whether the applicant has demonstrated that a new structure has earned a LEED rating or met a substantially equivalent standard. The Director may establish by rule procedures for determining whether an applicant has demonstrated that a new structure has earned a LEED rating or met any such substantially equivalent standard, provided that no rule shall assign authority for making a final determination to any person other than an officer of the Department of Planning and Development or another City agency with regulatory authority and expertise in green building practices.

C. Demonstration of compliance; penalties

1. The applicant shall demonstrate to the Director the extent to which the applicant has complied with the commitment to earn a LEED rating no later than 180 days after issuance of final Certificate of Occupancy for the new structure, or such later date as may be allowed by the Director for good cause, by submitting a report analyzing the extent credits were earned toward such rating from the U.S. Green Building Council or another independent entity approved by the Director. Performance is demonstrated through an independent report from a third party, pursuant to subsection 23.90.018.D. For purposes of this Section 23.48.025, if the Director shall have approved a commitment to achieve a substantially equivalent standard, the term "LEED rating" shall mean such other standard.

2. Failure to submit a timely report regarding a LEED rating from an approved independent entity by the date required is a violation of the Land Use Code. The penalty for such violation is \$500 per day from the date that the report was due to the date it is submitted, without any requirement of notice to the applicant.

3. Failure to demonstrate, through an independent report as provided in this subsection 23.48.025 D, full compliance with the applicant's commitment to earn a LEED rating, is a violation of the Land Use Code. The penalty for each violation is an amount determined as follows:

$$P = [(LSM-CE)/LSM] \times CV \times 0.0075, \text{ where:}$$

P is the penalty;

LSM is the minimum number of credits to earn the required LEED rating;

CE is the number of credits earned as documented by the report; and

CV is the Construction Value as set forth on the building permit for the new structure.

Example:

Construction Value	\$200,000,000.00
--------------------	------------------

Minimum LEED Credits for rating	33
Credits Earned	32
Penalty = $[(33-32)/33] \times 200,000,000 \times .0075 =$	\$45,454.55

4. Failure to comply with the applicant's commitment to earn a LEED rating is a violation of the Land Use Code independent of the failure to demonstrate compliance; however, such violation shall not affect the right to occupy any chargeable floor area, and if a penalty is paid in the amount determined under subsection 23.48.025.C.3, no additional penalty shall be imposed for the failure to comply with the commitment.

5. If the Director determines that the report submitted provides satisfactory evidence that the applicant's commitment is satisfied, the Director shall issue a certificate to the applicant so stating. If the Director determines that the applicant did not demonstrate compliance with its commitment to earn a LEED rating in accordance with this Section 23.48.025, the Director may give notice of such determination, and of the calculation of the penalty due, to the applicant.

6. If, within 90 days, or such longer period as the Director may allow for good cause, after initial notice from the Director of a penalty due under this subsection 23.48.025.C, the applicant shall demonstrate, through a supplemental report from the independent entity that provided the initial report, that it has made sufficient alterations or improvements to earn a LEED rating, or to earn more credits toward such a rating, then the penalty owing shall be eliminated or recalculated accordingly. The amount of the penalty as so re-determined shall be final. If the applicant does not submit a supplemental report in accordance with this subsection 23.48.025.C by the date required under this subsection 23.48.025.C, then the amount of the penalty as set forth in the Director's original notice shall be final.

7. Any owner, other than the applicant, of any lot on which the bonus development was obtained or any part thereof, shall be jointly and severally responsible for compliance and liable for any penalty due under this subsection 23.48.025.C.

D. Use of penalties. A subfund shall be established in the City's General Fund to receive revenue from penalties under subsection 23.48.025.C. Revenue from penalties under that subsection 23.48.025.C shall be allocated to activities or incentives to encourage and promote the development of sustainable buildings. The Director shall recommend to the Mayor and City Council how these funds should be allocated.

23.48.026 Noise standards

All permitted uses are subject to the noise standards of Section 23.47A.018.

23.48.028 Odor standards

All permitted uses are subject to the odor standards of Section 23.47A.020.

23.48.030 Light and glare standards

All permitted uses are subject to the light and glare standards of Section 23.47A.022.

23.48.032 Required parking and loading

A. Off-street parking spaces and bicycle parking are required according to Section 23.54.015, Required parking.

B. Maximum parking limit for non-residential uses, except for non-residential uses in the Mount Baker Station Overlay District.

1. Except as provided in subsections 23.48.032.B.2, 23.48.032.B.3, and 23.48.032.B.4 parking for non-residential uses, except in the Mount Baker Station Overlay District, is limited to one parking space per every 1,000 square feet of gross floor area in non-residential use.

2. Parking for nonresidential uses in excess of the maximum quantity identified in subsection 23.48.032.B.1 may be permitted as a special exception pursuant to Chapter 23.76. When deciding whether to grant a special exception, the Director shall consider evidence of

parking demand and the availability of alternative means of transportation, including but not limited to the following:

- a. Whether the additional parking will substantially encourage the use of single occupancy vehicles;
- b. Characteristics of the work force and employee hours, such as multiple shifts that end when transit service is not readily available;
- c. Proximity of transit lines to the lot and headway times of those lines;
- d. The need for a motor pool or large number of fleet vehicles at the site;
- e. Proximity to existing long-term parking opportunities within the area which might eliminate the need for additional parking;
- f. Whether the additional parking will adversely affect vehicular and pedestrian circulation in the area;
- g. Potential for shared use of additional parking as residential or short-term parking;
- h. The need for additional short-term parking to support retail activity in areas where short-term parking and transit service is limited.

3. If on or before September 1, 2012, a lot is providing legal off-site parking for another lot, by means such as a recorded parking easement or off-site accessory parking covenant on the subject lot, then the number of such off-site parking spaces is allowed on the off-site lot in addition to one space per 1,000 square feet for nonresidential uses on the subject lot.

4. A lot in the SM 85/65-160 zone may exceed the maximum parking limit in subsection 23.48.032.B without approval of a special exception pursuant to subsection 23.48.032.B.2 when, prior to issuance of a Master Use Permit for the lot that exceeds the maximum parking limit, the fee owners of both the property subject to the Master Use Permit for the lot that exceeds the maximum parking limit and the fee owners of the property subject to the Master Use Permit execute a restrictive covenant that is recorded in the King County real

property records that limits the amount of parking that can be provided on other lot(s), such that the total quantity of parking provided as part of the Master Use Permit together with the parking to be provided on the other lot(s) subject to the restrictive covenant does not exceed the maximum parking limit in subsection 23.48.032.B.

C. Loading berths shall be provided pursuant to Section 23.54.035, Loading berth requirements and space standards.

D. Where access to a loading berth is from an alley, and truck loading is parallel to the alley, a setback of 12 feet is required for the loading berth, measured from the centerline of the alley, as shown in Exhibit D for 23.47A.014. This setback shall be maintained up to a height of 16 feet.

23.48.034 Parking and loading location, access and curbcuts

A. Parking accessory to nonresidential uses may be provided on-site and/or within 800 feet of the lot to which it is accessory, according to the provisions of Section 23.54.025, Parking covenants.

B. Parking location within structures

1. Parking at street level

a. Except as permitted under subsections 23.48.034.B.1.b and 23.48.034.B.1.c, parking is not permitted at street-level unless separated from the street by other uses, provided that garage doors need not be separated.

b. Due to physical site conditions such as topographic or geologic conditions, parking is permitted in stories that are partially below street-level and partially above street level without being separated from the street by other uses, if:

1) The street front portion of the parking that is at or above street-level does not abut a Class 1 Pedestrian Street requiring street-level uses; and

2) The street front portion of the parking that is at or above street-level, excluding garage and loading doors and permitted access to parking, is screened from view at the street-level; and

3) The street-facing facade is enhanced by architectural detailing, artwork, landscaping, stoops and porches providing access to residential uses, or similar visual interest features.

c. Parking is permitted in a story that is partially above street-level and partially below street-level in a structure permitted in a setback area under the provisions of subsection 23.48.014.B.2.b.

2. Parking above the first story of a structure. The following provisions apply to development in the SM 85/65-125, SM 85/65-160, SM 160/85-240, SM 85-240, and SM 240/125-400 zones within the South Lake Union Urban Center:

a. Except as provided in subsection 23.48.034.B for parking partially above street-level and partially below street-level, parking within structures is permitted above the first story under the following conditions:

1) One story of parking is permitted above the first story of a structure for each story of parking provided below grade that is of at least equivalent capacity, up to a maximum of two stories of parking above the first story.

2) For parking located on a story above the first story of a structure, a minimum of 30 percent of the length of the parking area measured along each street frontage shall be separated from the street by another use. On lots located at street intersections, the separation of parking area by another use shall be provided at the corner portion(s) of the structure.

3) The parking area on a story above the first story of the structure that is not separated from the street by another use shall be enclosed by facades along all street

frontages. Facades shall be designed to minimize the impacts of glare from vehicle headlights and interior garage lighting on pedestrian views from the street.

b. The Director may permit more than two stories of parking above the first story of the structure, or may permit other exceptions to subsection 23.48.034.B.2, as a Type I decision, if the Director finds that locating parking below grade is infeasible due to physical site conditions such as a high water table or proximity to a tunnel. In such cases, the Director shall determine the maximum feasible amount of parking that can be provided below grade, if any, and the amount of additional parking to be permitted above street level. Site size is not a basis for granting an exception under this subsection 23.48.034.B.2.b.

C. Accessory surface parking is permitted under the following conditions:

1. All accessory surface parking shall be located at the rear or to the side of the principal structure.
2. The amount of lot area allocated to accessory surface parking shall be limited to 30 percent of the total lot area.
3. In the SM 85/65-125, SM 85/65-160, SM 160/85-240, SM 85-240, and SM 240/125-400 zones in the South Lake Union Urban Center, accessory surface parking is prohibited unless separated from all street lot lines by another use within a structure.

D. Parking and loading access. If a lot abuts more than one right-of-way, the location of access for parking and loading shall be determined by the Director, depending on the classification of rights-of-way, as shown on Maps A and B for 23.48.014, according to the following:

1. Access to parking and loading shall be from the alley when the lot abuts an alley improved to the standards of subsection 23.53.030.C and use of the alley for parking and loading access would not create a significant safety hazard as determined by the Director.
2. If the lot does not abut an improved alley, or use of the alley for parking and loading access would create a significant safety hazard as determined by the Director, parking

and loading access may be permitted from the street. If the lot abuts more than one street, the location of access is determined by the Director, as a Type I decision, after consulting with the Director of Transportation. Unless the Director otherwise determines under subsection 23.48.034.D.3.c, access is allowed only from a right-of-way in the category, determined by the classifications shown on Maps A and B for 23.48.014, that is most preferred among the categories of rights-of-way abutting the lot, according to the ranking set forth below, from most to least preferred (a portion of a street that is included in more than one category is considered as belonging only to the least preferred of the categories in which it is included).

- a. An undesignated street;
- b. Class 2 Pedestrian Street;
- c. Class 1 Pedestrian Street;
- d. Designated Neighborhood Green Street.

3. The Director may allow or require access from a right-of-way other than one indicated by subsection 23.48.034.D.1 or subsection 23.48.034.D.2 if, after consulting with the Director of Transportation on whether and to what extent alternative locations of access would enhance pedestrian safety and comfort, facilitate transit operations, facilitate the movement of vehicles, minimize the on-street queuing of vehicles, enhance vehicular safety, or minimize hazards, the Director finds that an exception to the access requirement is warranted. Curb cut controls on designated green streets shall be evaluated on a case-by-case basis, but generally access from green streets is not allowed if access from any other right-of-way is possible.

E. Curb cut width and number

1. Permitted access shall be limited to one two-way curbcut. In the event the site is too small to permit one two-way curbcut, two one-way curbcuts shall be permitted.

2. Curbcut width and number of curbcuts shall satisfy the provisions of Section 23.54.030, except as modified in this Section 23.48.034.

23.48.035 Assisted living facilities

A. In addition to the requirements of subsection 23.48.035.B, assisted living facilities are subject to the development standards of the zone where they are located, except that density limits and amenity area requirements do not apply to assisted living facilities.

B. Other requirements

1. Minimum unit size. Assisted living units shall be designed to meet the minimum square footage required by WAC 388-110-140.

2. Facility kitchen. An on-site kitchen that serves the entire assisted living facility is required.

3. Communal area. Communal areas that are either interior or exterior spaces, such as solariums, decks and porches, recreation rooms, dining rooms, living rooms, foyers and lobbies, and gardens or other outdoor landscaped areas shall be provided as follows:

a. The total amount of communal area shall equal at least 10 percent of the total floor area in assisted living units. In calculating the total floor area in assisted living units, all of the area of each unit, excluding the bathroom, shall be counted, including counters, closets and built-ins;

b. Service areas, including, but not limited to, the facility kitchen, laundry, hallways and corridors, supply closets, operations and maintenance areas, staff areas and offices, and rooms used only for counseling or medical services, shall not be counted as required communal area; and

c. A minimum of 400 square feet of the required communal area shall be provided as an outdoor area with a minimum dimension of 10 feet. Outdoor areas provided as required communal area shall be accessible to people with disabilities.

d. Adequate seating for residents and guests shall be provided for required communal areas.

23.48.036 Pet daycare centers

In addition to the development standards of the zone, pet daycare centers are subject to the following requirements:

A. Pet daycare centers that were established of record before July 31, 2006, may continue notwithstanding nonconformity with development standards, provided the provisions of this Section 23.48.036 are met.

B. The pet daycare center shall be permitted by the Public Health—Seattle and King County, as required by Section 10.72.020.

C. Facilities for the boarding of animals may occupy no more than 30 percent of the gross floor area of the pet daycare center.

D. Required loading pursuant to Section 23.54.015 may be provided in a public right-of-way if the applicant can demonstrate to the Director, in consultation with the Director of Transportation, that pedestrian circulation or vehicle traffic will not be significantly impacted.

E. Applicants shall submit at the time of permit application, written operating procedures, such as those recommended by the American Boarding and Kennel Association (ABKA) or the American Kennel Club (AKC). Such procedures shall be followed for the life of the business and shall prevent animal behavior that impacts surrounding uses, including excessive barking.

F. Violations of this Section 23.48.036

1. The exemption in subsection 25.08.500.A of the Noise Control Ordinance to uses permitted under Chapter 10.72, provisions for pet kennels and similar uses, does not apply to pet daycare centers.

2. When a notice of violation is issued for animal noise, the Director may require the pet daycare center to submit a report from an acoustical consultant that describes potential measures to be taken by the pet daycare center to prevent or mitigate noise impacts. The Director may require measures, including but not limited to: development or modification of operating procedures; cessation of the use of outdoor area(s); closure of windows and doors; reduction in

hours of operation; and use of sound attenuating construction or building materials such as insulation and noise baffles. The Director may order the pet daycare center to be closed on a temporary or permanent basis.

Subchapter III. Nonconforming Uses and Structures

23.48.038 Relocating landmark structures

When an historic landmark structure is relocated, any nonconformities with respect to development standards shall transfer with the relocated structure.