



SEATTLE CITY COUNCIL

Legislative Summary

CB 119622

Record No.: CB 119622

Type: Ordinance (Ord)

Status: Passed

Version: 2

Ord. no: Ord 125946

In Control: City Clerk

File Created: 08/22/2019

Final Action: 10/04/2019

Title: AN ORDINANCE relating to pedestrian and business interactions in the public place; making updates to regulations for cafés in the public place; making updates to pedestrian clearance standards to align with existing standards and amendments to clarify regulations; making technical corrections; and amending Chapter 15.16 and Sections 15.02.042, 15.02.044, 15.02.046, 15.02.048, 15.04.035, 15.04.060, 15.04.070, 15.17.005, 15.17.006, 15.17.007, 15.17.008, 15.17.009, 15.17.100, 15.17.120, 15.17.130, 15.17.150, 15.17.152, 15.17.200, 15.32.200, and 15.32.250 of the Seattle Municipal Code.

Date

Notes:

Filed with City Clerk:

Mayor's Signature:

Sponsors: O'Brien

Vetoed by Mayor:

Veto Overridden:

Veto Sustained:

Attachments: Full Text: CB 119622 v2

Drafter: amy.gray@seattle.gov

Filing Requirements/Dept Action:

History of Legislative File

Legal Notice Published:

Yes

No

Ver- sion:	Acting Body:	Date:	Action:	Sent To:	Due Date:	Return Date:	Result:
1	Mayor	08/27/2019	Mayor's leg transmitted to Council	City Clerk			
1	City Clerk	08/27/2019	sent for review	Council President's Office			
	Action Text: The Council Bill (CB) was sent for review. to the Council President's Office						
1	Council President's Office	08/29/2019	sent for review	Sustainability and Transportation Committee			
	Action Text: The Council Bill (CB) was sent for review. to the Sustainability and Transportation Committee						

Legislative Summary Continued (CB 119622)

1	City Council	09/09/2019	referred	Sustainability and Transportation Committee	
1	Sustainability and Transportation Committee	09/17/2019	pass as amended		Pass
	Action Text:	The Committee recommends that City Council pass as amended the Council Bill (CB).			
		In Favor: 1 Chair O'Brien			
		Opposed: 0			
2	City Council	09/23/2019	passed		Pass
	Action Text:	The Council Bill (CB) was passed by the following vote, and the President signed the Bill:			
		In Favor: 7 Councilmember Bagshaw, Councilmember González , Council President Harrell, Councilmember Juarez, Councilmember Mosqueda, Councilmember O'Brien, Councilmember Pacheco			
		Opposed: 0			
		Absent(NV): 2 Councilmember Herbold, Councilmember Sawant			
2	City Clerk	09/27/2019	submitted for Mayor's signature	Mayor	
2	Mayor	10/04/2019	Signed		
	Action Text:	The Council Bill (CB) was Signed.			
2	Mayor	10/04/2019	returned	City Clerk	
	Action Text:	The Council Bill (CB) was returned. to the City Clerk			
2	City Clerk	10/04/2019	attested by City Clerk		
	Action Text:	The Ordinance (Ord) was attested by City Clerk.			

CITY OF SEATTLE

ORDINANCE 125946

COUNCIL BILL 119622

AN ORDINANCE relating to pedestrian and business interactions in the public place; making updates to regulations for cafés in the public place; making updates to pedestrian clearance standards to align with existing standards and amendments to clarify regulations; making technical corrections; and amending Chapter 15.16 and Sections 15.02.042, 15.02.044, 15.02.046, 15.02.048, 15.04.035, 15.04.060, 15.04.070, 15.17.005, 15.17.006, 15.17.007, 15.17.008, 15.17.009, 15.17.100, 15.17.120, 15.17.130, 15.17.150, 15.17.152, 15.17.200, 15.32.200, and 15.32.250 of the Seattle Municipal Code.

WHEREAS, the 2015 ten-year Move Seattle Strategy identified the need to transform Seattle’s streets and sidewalks into vibrant social spaces and called for creating more places for people to use our streets and sidewalks; and

WHEREAS, the pilot streatery and fence-free café programs have demonstrated success and additional opportunities to offer outdoor seating options in the right-of-way are well-supported by businesses and customers; and

WHEREAS, the 2017 Pedestrian Master Plan established a specific goal to create and maintain a pedestrian clear zone on all sidewalks consistent with the Right-of-Way Improvements Manual to improve pedestrian mobility; and

WHEREAS, The City of Seattle is committed to economic development and creating business opportunities for food-service businesses; promoting activation of public spaces; identifying missed opportunities or implementation hurdles to activating the public right-of-way, and managing public spaces in a transparent and predictable way; NOW,

THEREFORE,

BE IT ORDAINED BY THE CITY OF SEATTLE AS FOLLOWS:

1 Section 1. Section 15.02.042 of the Seattle Municipal Code, last amended by Ordinance
2 124951, is amended as follows:

3 **15.02.042 Definitions A through C**

4 * * *

5 J. “Café” means a portion of the public place where tables and seating are placed for the
6 use of patrons consuming food or beverages, including alcoholic beverages, that is operated by a
7 food service business located on abutting property, unless its location is otherwise approved by
8 the Seattle Department of Transportation. Cafés on the sidewalk abutting the property line are
9 called “frontage zone cafés,” cafés in the planting strip portion of the sidewalk are called
10 “furniture zone cafés,” and cafés in the curb space are called “curb space cafés.”

11 K. "Communication cabinet" means all structures, cabinets, electric meters, and any other
12 appurtenances installed in the public place, except utility poles and attachments to poles; by any
13 publicly- or privately-owned entity for the purposes of providing any communications
14 transmission, emission, or reception of signals, writings, pictures, images, and sounds or
15 intelligence of any nature; by wire, cable, radio, optical, or other electromagnetic systems.

16 ((K)) L. "Compaction" means "compaction" as defined in Section 22.801.040.

17 ((L)) M. "Contaminate" means "contaminate" as defined in Section 22.801.040.

18 ((M. “Corner curb radius area” means the area that includes the intersection of two
19 sidewalks bounded by the adjoining corner or curb bulb and curb ramps (Exhibit B for
20 15.02.042: Corner curb radius area). If the start of the point of curvature for the curb bulb or
21 curb radius occurs beyond the sidewalk intersections, the area shall be extended to the point of
22 curvature for the curb bulb or curb radius.))

1 N. "Corner clearance zone" means the area that includes the intersection of two sidewalks
2 and extends on the sidewalk to whichever is farther: 5 feet from the intersection of two
3 sidewalks; or the far edge of a marked crosswalk or curb ramp, as illustrated in Exhibit B for
4 15.02.042.

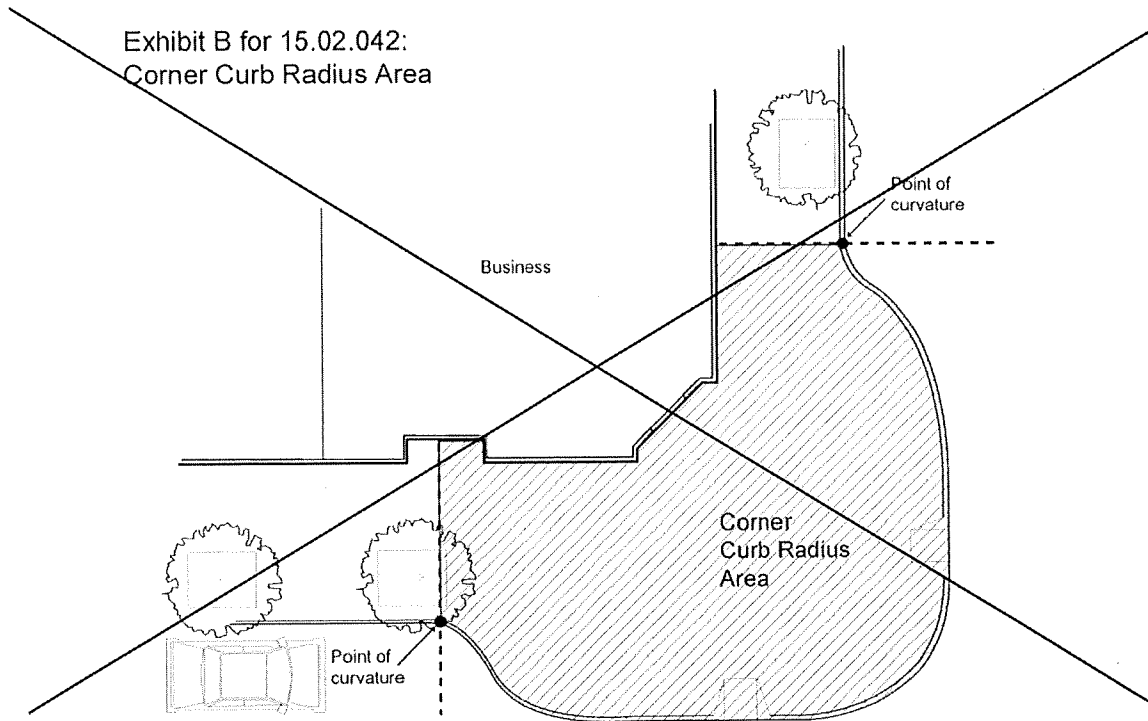

5

Exhibit B for 15.02.042
Corner Clearance Zone

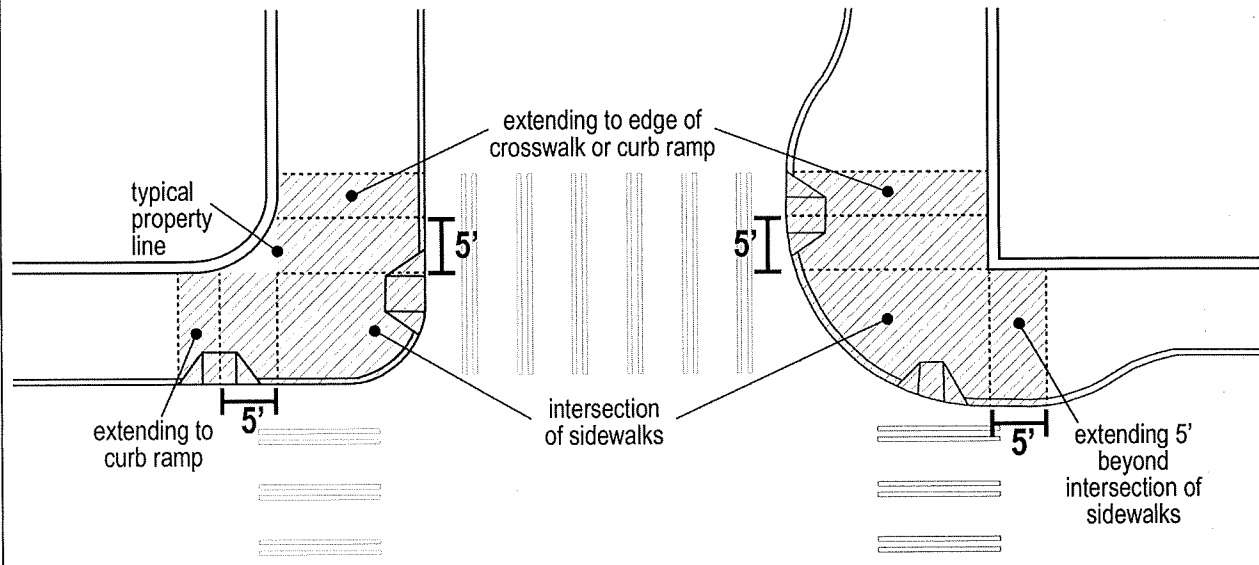

1

2 Section 2. Section 15.02.044 of the Seattle Municipal Code, last amended by Ordinance
3 124951, is amended as follows:

4 **15.02.044 Definitions D through M**

5 * * *

6 B. “Director of the ((Department of Planning and Development²)) Seattle Department of
7 Construction and Inspections” means the Director of the ((Department of Planning and
8 Development²)) Seattle Department of Construction and Inspections or authorized
9 representatives.

10 * * *

11 Section 3. Section 15.02.046 of the Seattle Municipal Code, last amended by Ordinance
12 124951, is amended as follows:

13 **15.02.046 Definitions N through Z**

14 * * *

1 C. "Peak period" means the peak traffic periods as defined in the current edition of the
2 City of Seattle Traffic Control Manual for In-Street Work as provided for in Chapter 11.12(
3 ~~Vehicles and Traffic~~)).

4 D. "Pedestrian clear zone" means the area ((~~or space of the public place or roadway that~~
5 ~~is reserved for the exclusive use of pedestrians (Exhibit A for 15.02.046: Pedestrian~~
6 ~~Zone/Pedestrian Visual Corridor~~)) of the public place that is specifically reserved for pedestrian
7 travel. Street furniture, plantings, and other obstructions shall not protrude into this zone.

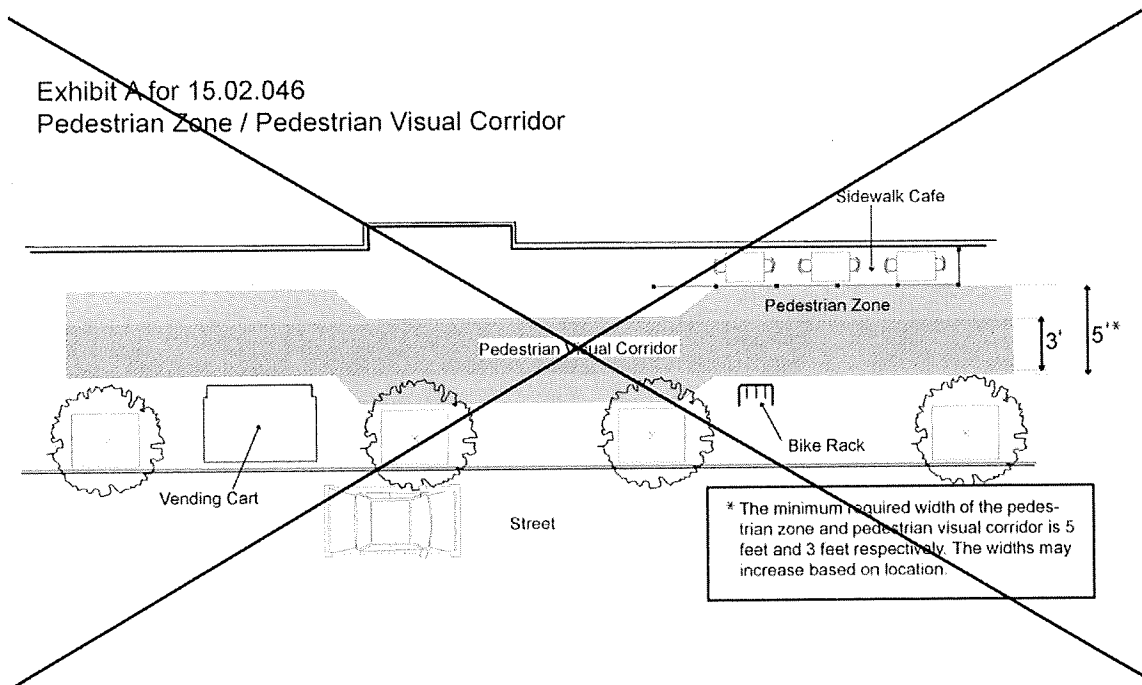

8
9
10 E. (~~"Pedestrian visual corridor" means a continuous and straight corridor within the~~
11 ~~designated pedestrian zone that provides pedestrians with a clear visual indication of the location~~
12 ~~of the path of travel along a block face (Exhibit A for 15.02.046: Pedestrian Zone/Pedestrian~~
13 ~~Visual Corridor). Street furniture, plantings, and other obstructions shall not protrude into this~~
14 ~~corridor.)) "Pedestrian straight path" means a 3-foot-wide continuous, straight, and unobstructed~~

1 corridor within the designated pedestrian clear zone that extends along the permitted area and for
2 25 feet on either end of the permitted area's boundaries along the block face. The pedestrian
3 straight path provides pedestrians with a clear indication of the travel path location, usually
4 parallel to the curb, and dictates that the pedestrian clear zone shall be generally straight with no
5 sharp turns.

6 * * *

7 ~~((O))~~ O. "Sidewalk café" means a portion of the public place in which tables and chairs are
8 placed for the use of patrons consuming food or beverages including alcoholic beverages that is
9 operated by a food service business located on abutting property.

10 P)) O. "Sign" means any medium, including its structure and component parts that is used
11 or intended to be used out of doors to attract attention to the subject matter for advertising,
12 identification, or informative purposes.

13 ((Q)) P. "SMC" ~~((is an abbreviation for))~~ means the Seattle Municipal Code.

14 ((R)) Q. "Street tree" means any tree planted or growing within a public place.

15 ((S)) R. "Street Tree Inventory" means a database or list of trees growing in public places,
16 that includes attributes such as species, size, tree condition, location, and maintenance
17 responsibility, as maintained by the Director of Transportation.

18 ((T)) S. "Street Tree Manual" means the Department of Transportation's Tree Standards
19 Manual for planting, pruning, maintenance, and protection of trees in public places, as adopted
20 by Director's Rule.

21 ((U)) T. "Stormwater" means "stormwater" as defined in Section 22.801.200.

22 ((V)) U. "Superintendent" or "Superintendent of Parks and Recreation" means the City
23 Superintendent of Parks and Recreation or authorized representatives.

1 ~~((W))~~ Y. "Topping" means the severe and indiscriminate cutting back of limbs to stubs
2 within the tree's crown, to such a degree as to remove the normal canopy and disfigure the tree;
3 or the cutting back of limbs or branches to lateral branches that are not sufficiently large enough
4 to assume the terminal role, or are less than one-half of the diameter of the limb or branch that is
5 cut.

6 ~~((X))~~ W. "Tree Service Provider" means any individual or business entity that engages in
7 the business of pruning, removing, or otherwise treating trees for monetary or other
8 compensation.

9 ~~((Y))~~ X. "Vend or vending" means to sell, offer for sale, solicit orders, display, rent,
10 lease, or otherwise peddle any good, ticket, thing, or service of any kind; to the public from a
11 public place; as authorized or prohibited in Chapters 15.14 or 15.17.

12 ~~((Z))~~ Y. "Vending cart" means a movable cart that is used to serve, vend, or provide food,
13 nonalcoholic beverages, or flowers.

14 Section 4. Section 15.02.048 of the Seattle Municipal Code, last amended by Ordinance
15 123830, is amended as follows:

16 **15.02.048 Definitions—Use**

17 A. "Use" means exercising dominion or control over ~~((7))~~ or occupying all or part of ~~((8))~~
18 a public place with or without the right to do so. Use includes constructing, storing, erecting,
19 placing upon, maintaining, or operating; any inanimate thing or object; in, upon, over, or under
20 any public place. It includes, but is not limited to, any of the following:

21 1. Any areaway, marquee, awning, clock, newsstand, sign, banner, billboard,
22 sidewalk elevator or door, fuel opening, ~~((sidewalk))~~ café in the public place, or other
23 structure;

1 2. Fencing, staging, scaffolding, an elevator or other structure or material,
2 machinery or tools used or to be used in connection with excavating, erecting, altering,
3 demolishing, repairing, maintaining, or painting any building;

4 3. Moving any building along or across any public place;

5 4. Storing or placing any material, equipment, inanimate object, or thing in any
6 public place. But "use" shall not include placing an inanimate object in a location and for a
7 limited duration of time that, under the circumstances, no reasonable person could conclude
8 that the public's right to use or enjoy the public place, in whole or in part, has been or
9 potentially could be interfered with;

10 5. Raising or lowering any safes, machinery, or other heavy articles;

11 6. Making or having any fire on any public place;

12 7. Opening, excavating, or in any manner disturbing or breaking the surface or
13 foundation of any permanent pavement; or altering the established grade of any public place;
14 or disturbing the surface of, digging up, cutting, excavating, or filling in any public place;

15 8. Constructing, reconstructing, repairing, or removing any driveway, curb,
16 curb setback, sidewalk, crosswalk, pavement, sewers, water mains, grading, street lighting,
17 street utilities, or appurtenances; or doing any work in, or erecting any structure under, along,
18 or over any public place; except when permitted by ordinance;

19 9. Vending of any good, ticket, thing, or service of any kind, (~~other than~~
20 publications under) except: placing newsstands in compliance with Chapter 15.14; or vending
21 merchandise on foot that is protected as expressive activity under the United States or
22 Washington Constitution as defined by rules adopted pursuant to Section 15.17.200 and without
23 engaging in any other use of the public space as defined in this Section 15.02.048;

1 10. Using sound amplifying equipment, other than aids for ~~((the disabled))~~

2 persons with disabilities; or

3 11. Closing or altering the appearances of streets; including filming, block parties,

4 or street fairs.

5 * * *

6 Section 5. Section 15.04.035 of the Seattle Municipal Code, last amended by Ordinance
7 124951, is amended as follows:

8 **15.04.035 Approval(~~(; Considerations))~~ and considerations**

9 A. If the application conforms to the requirements of Title 15 and the proposed use is
10 consistent with the rights of the public to use the public place, the authorizing official may
11 approve the application; fix the duration and the terms or conditions of the permit; and when
12 required ~~((;))~~ upon the applicant's furnishing of a deposit or surety bond, insurance, covenant,
13 and indemnification, and payment of all required fees ~~((;))~~, issue the permit. The original permit
14 shall ~~((remain in the custody of))~~ be retained by the City, and a copy shall be given to the
15 permittee and shall be posted or available at the site by the permittee.

16 1. The Director of Transportation may, as deemed appropriate, condition the
17 Street Use permit to address the potential impacts associated with the permitted activity.

18 2. The Director of Transportation may require applicants to establish an escrow
19 account in accordance with Section 15.04.042 or post a surety bond in accordance with Section
20 15.04.044.

21 B. The permit may specify the portion of the public place that may be occupied, the
22 dates or days and hours of use, and the allowed use. The permit shall only be valid for the

1 portion of the public place, the dates or days and hours of use, and the use as identified on the
2 permit.

3 C. Factors for consideration in evaluating an application for a permit include, but are not
4 limited to, the applicant's constitutional rights and the abutter's property rights; the site and its
5 terrain; the public and private benefits of the proposed use; and the impact of the proposed use
6 on the following:

- 7 1. The paramount purpose of streets for travel and transportation;
- 8 2. Utilities; authorized secondary street uses; and any use being made by the
9 public of the site;
- 10 3. Fire access and public safety;
- 11 4. Uses under permit; street trees; and other proposed or past uses of the site;
- 12 5. Rights of light, air, and access and lateral support of abutting properties and on
13 access or easements of properties dependent upon the public place for access;
- 14 6. The environment, including but not limited to efforts to minimize impervious
15 surface, loss of native vegetation, and stormwater runoff;
- 16 7. Drainage, surface, and underground; springs and watercourses; and the stability
17 of soils; and
- 18 8. Where applicable, City land use, transportation, open space, shoreline, and
19 beautification policies and approved neighborhood land use plans.

20 D. In addition to the considerations in subsection 15.04.035.B, where the following
21 situations occur, factors for consideration include:

- 22 1. For public places under the jurisdiction of the Department of Parks and
23 Recreation, their character as a park drive or boulevard, or as open space;

1 2. For shoreline street ends, their purpose to provide the public with visual or
2 physical access to the water and the shoreline;

3 3. For submerged streets, ~~((the Harbor Code,))~~ Title 16;

4 4. For environmentally critical areas, the requirements of Chapter 25.09; and

5 5. For streets or public places in the process of being vacated, the use after the
6 vacation.

7 E. The Director of Transportation may grant a deviation from required standards using
8 the process specified in the Right-of-Way Improvements Manual or successor rule upon
9 determining that adequate space is provided for pedestrian passage, traffic management, and any
10 other public-use purpose.

11 Section 6. Section 15.04.060 of the Seattle Municipal Code, last amended by Ordinance
12 123830, is amended as follows:

13 **15.04.060 Indemnity agreements and covenants**

14 A. The permittee, or the owner of the object or improvement identified in the permit
15 application if the permittee is not the owner, shall agree to defend, indemnify, and hold harmless
16 ~~((the))~~ The City of Seattle, its officials, officers, employees, and agents from and against:

17 1. Any liability, claims, actions, suits, loss, costs, expense judgments, attorneys'
18 fees, or damages of every kind and description resulting directly or indirectly from any act or
19 omission of the permittee, its subcontractors, anyone directly or indirectly employed by them,
20 and anyone for whose acts or omissions they may be liable, arising out of the permittee's use or
21 occupancy of the public place; and

22 2. All loss by the failure of the permittee to fully or adequately perform, in any
23 respect, all authorizations ~~((of))~~ or obligations under permit.

1 B. If the application is for a permit to use or occupy a public place with an areaway, fuel
2 opening, sidewalk elevator or door, ((a)) bulkhead, ((steps)) retaining wall, rockery, structure, or
3 ((an)) extension or appurtenance to a structure, or any facility with an anticipated continued
4 occupancy of a public place of more than one year; the owner of the adjacent property ((s)) and
5 any existing lessee, sublessee, tenant, and subtenant using or occupying the part of the premises
6 served or connected to the permitted use shall, in the manner provided by law for the execution
7 of deeds, execute and deliver to the City upon a form to be supplied by the authorizing official,
8 an agreement in writing ((s)) signed and acknowledged by the owners and by any existing lessee,
9 sublessee, tenant, and subtenant; containing an accurate legal description of the premises;
10 covenanting on the part of the owner, lessee, sublessee, tenant, and subtenant, for themselves and
11 their heirs, executors, administrators, successors, assigns, lessees, sublessees, tenants, and
12 subtenants; and forever defending, indemnifying, and holding harmless the City, its officials,
13 officers, employees, and agents from and against any and all claims, actions, suits, liability, loss,
14 costs, expense, attorneys' fees, or damages of every kind and description, excepting only
15 damages that may result from the sole negligence of the City; that may accrue to, be asserted by,
16 or be suffered by, any person or property((s)) including without limitation ((s)) damage, death, or
17 injury to members of the public or to the permittee's officers, agents, employees, contractors,
18 invitees, tenants, ((and)) tenants' invitees, and licensees or its successors and assigns; arising out
19 of or by reason of:

20 1. The existence, condition, construction, reconstruction, modification,
21 maintenance, operation, use, or removal of the permitted area or any portion thereof, or the use,
22 occupation, or restoration of the public place or any portion thereof by the owner, lessee,

1 sublessee, tenant and subtenant, heirs, executors, administrators, successors, or assigns ((;
2 lessees, sublessees, tenants and subtenants)) ;

3 2. Anything that has been done or may at any time be done by the owner, lessee,
4 sublessee, tenant and subtenant, heirs, executors, administrators, successors, or assigns ((;
5 lessees, sublessees, tenants and subtenants by reason of the permit)) ; or

6 3. The owner, lessee, sublessee, tenant and subtenant, heirs, executors,
7 administrators, successors, or assigns ((, lessees, sublessees, tenants and subtenants)) failing or
8 refusing to strictly comply with every provision of the permit; or arising out of or by reason of
9 the permit in any other way.

10 C. If the application is for a permit to construct and maintain an areaway ((;)) , the
11 agreement shall also contain a covenant on the part of the permittee executing the agreement ((;))
12 for themselves and their heirs, executors, administrators, successors, or assigns ((, lessees,
13 sublessees, tenants, and subtenants)); assuming the duty of inspecting and maintaining all
14 services, instrumentalities, and facilities installed in the areaway to be constructed or occupied
15 under authority of the permit; and assuming all liability for ((;)) , and at all times defending,
16 indemnifying, and holding harmless the City, its officials, officers, employees, and agents from
17 and against, all claims, actions, suits, liability, loss, costs, expense, attorneys' fees, or damages of
18 every kind and description, excepting only damages that may result from the sole negligence of
19 the City ((;)) that may accrue to, be asserted by, or be suffered by any person or property, ((;))
20 including without limitation ((;)) damage, death, or injury to members of the public or to the
21 permittee's officers, agents, employees, contractors, invitees, tenants and tenants' invitees,
22 licensees, or its successors and assigns; arising out of or by reason of:

1 1. The existence, condition, construction, reconstruction, modification,
2 maintenance, operation, use, or removal of the permitted area or any portion thereof, or the use,
3 occupation, or restoration of the public place or any portion thereof by the owner, lessee,
4 sublessee, tenant and subtenant, heirs, executors, administrators, successors, or assigns (~~(;~~
5 ~~lessees, sublessees, tenants and subtenants)~~);

6 2. Anything that has been done or may at any time be done by the owner, lessee,
7 sublessee, tenant and subtenant, heirs, executors, administrators, successors, or assigns (~~(;~~
8 ~~lessees, sublessees, tenants and subtenants)~~) by reason of the permit; or

9 3. The owner, lessee, sublessee, tenant and subtenant, heirs, executors, administrators,
10 successors, or assigns (~~(;~~~~lessees, sublessees, tenants and subtenants)~~) failing or refusing to
11 strictly comply with every provision of the permit; or arising out of or by reason of the permit in
12 any other way.

13 D. All agreements shall be a covenant running with the land.

14 ~~((D))~~ E. In addition, the agreement shall contain a provision that the permit:

15 1. Is wholly of a temporary nature;

16 2. Vests no permanent right whatsoever; and

17 3. May be revoked, the structures and obstructions removed, and public
18 place restored to the condition that existed prior to use occurring in the public place upon 30(~~(-~~
19 ~~))calendar days' notice, posted on the premises, or published in the official newspaper of the
20 City; or without notice(~~(;~~) if the permitted use is dangerous or the (~~(structures))~~ structure is
21 insecure or unsafe, or is not constructed, maintained, or used in accordance with the provisions
22 of this Title 15.~~

1 ((E)) F. An agreement, after it has been received and recorded with the King County
2 ((Department of Records and Elections)) Recorder's Office, shall be retained by the City Clerk
3 in the files and records of the Clerk's office.

4 ((F)) G. The authorizing official may waive execution of the signature on an agreement
5 by a tenant or subtenant on a month-to-month lease or on a tenancy at will. If the application is
6 made by a condominium or cooperative apartment, the authorizing official may accept an
7 agreement by the condominium or apartment association together with documentation showing
8 its authority to execute the agreement in lieu of executing the agreement by all unit or apartment
9 owners.

10 Section 7. Section 15.04.070 of the Seattle Municipal Code, last amended by Ordinance
11 123830, is amended as follows:

12 **15.04.070 Permit duration, revocation, and public place restoration**

13 A. All use authorizations approved under the provisions of Title 15 or Chapter 23.76(
14 ~~Procedures for Master Use Permits and Council Land Use Decisions~~)), or as to public places
15 under the jurisdiction of the Department of Parks and Recreation under Chapter 18.12, shall be
16 of a temporary nature and shall vest no permanent right((;)) , and may in any case be revoked
17 upon 30((-)) calendar days' notice; or without notice((;)) in case any use or occupation is
18 dangerous or any structure or obstruction permitted is insecure or unsafe; or is not constructed,
19 maintained, or used in accordance with the provisions of this Title 15.

20 B. If a permit to use a public place is revoked or terminated, the public place shall be
21 restored to the condition that existed prior to use occurring in the public place.

22 C. The Director of Transportation may modify the conditions of a Street Use permit after
23 providing the permittee with written notice ten days before modifying the permit. A copy of the

1 modified Street Use permit shall be mailed by first-class mail to the permittee at the address
2 listed on the Street Use permit application.

3 Section 8. Chapter 15.16 of the Seattle Municipal Code, last amended by Ordinance
4 124159, is amended as follows:

5 **CHAPTER 15.16 (~~(SIDEWALK CAFES)~~) CAFÉS IN THE PUBLIC PLACE**

6 **15.16.010 Permit required**

7 No person shall operate a (~~(sidewalk)~~) café in the public place without obtaining a Street Use
8 permit from the Director of Transportation as provided for in this Chapter 15.16 and Section
9 15.04.010. (~~(A Street Use permit to operate a sidewalk café shall not be transferred or assigned.)~~)

10 **15.16.012 Permit expiration, renewal, administration, and revocation**

11 A. A Street Use permit for a (~~(sidewalk)~~) café in the public place expires if: the business
12 changes ownership or the business vacates the premises, except when a permit transfer is
13 approved by the Director of Transportation; the Street Use permit duration expires; or Street Use
14 permit fees are not paid as required by subsection (~~(15.04.074.B)~~) 15.04.074.D. All permit-
15 related encroachments shall be removed from the public place when the Street Use permit
16 expires. (~~(Street Use permits for a sidewalk café shall not be transferrable or assignable.)~~)

17 B. The Director of Transportation may, upon issuing the annual Street Use permit invoice
18 and (~~(receipt of)~~) receiving the renewal fee, renew a (~~(sidewalk café)~~) Street Use permit
19 provided: the permittee is in compliance with all permit conditions; the ownership or business
20 has not changed; and the space is not needed for transportation, utility, or any other public-use
21 purpose.

22 C. (~~(The Director of Transportation may modify the conditions of a sidewalk café Street~~
23 ~~Use permit, including permitted hours or days of operation, after providing the permittee with~~

1 ~~written notice ten days before modifying the Street Use permit. A copy of the modified Street~~
2 ~~Use permit shall be mailed by first class mail to the permittee at the address listed on the Street~~
3 ~~Use permit application. The permittee may request a Director's review of the decision to modify~~
4 ~~the conditions of the Street Use permit as provided for in Section 15.04.112.~~

5 D.) All ((sidewalk café)) Street Use permits for cafés in the public place authorized by
6 Chapter 15.16 are of a temporary nature, vest no permanent rights, and are revocable and
7 modifiable as provided for in Section 15.04.070. The Director of Transportation may suspend
8 any sidewalk café Street Use permit for transportation mobility or public safety purposes; or to
9 coordinate with((:)) permitted Special Events authorized by Chapter 15.52, parade permits
10 authorized by Chapter 11.25, or any other permitted activity.

11 ~~((15.16.020 Permit application~~

12 ~~In addition to the information required by Section 15.04.025, a sidewalk café Street Use permit~~
13 ~~application shall state the anticipated periods of use during the year; the proposed hours of daily~~
14 ~~use including Saturdays, Sundays, and holidays; and whether any liquor, as defined in RCW~~
15 ~~66.04.010(6), will be sold or consumed in the area to be covered by the sidewalk café Street Use~~
16 ~~permit.))~~

17 **15.16.040 Terms and conditions**

18 ~~((A. The Director of Transportation may issue a Street Use permit authorizing the use of~~
19 ~~a public place for a sidewalk café under the following requirements as depicted in Exhibit A for~~
20 ~~15.16.040: Sidewalk Café Location:~~

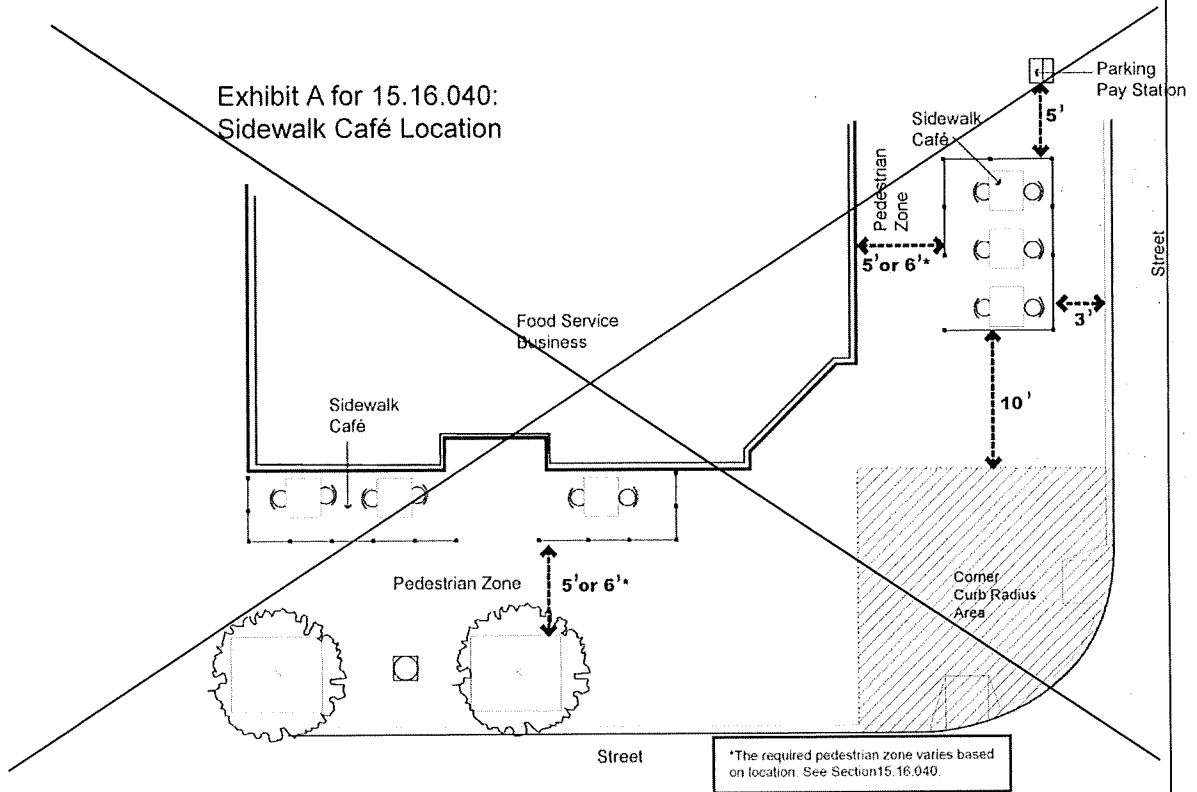

1

2 1. The applicant is the owner or occupant of the abutting property and operates a
3 food service business;

4 2. As depicted in Exhibit A for 15.02.046: Pedestrian Zone/Pedestrian Visual
5 Corridor; a proposed use for a sidewalk café and all associated elements including fencing,
6 umbrellas, or signage, shall not impair pedestrian passage and shall be sited to provide:

7 a. An unobstructed corner curb radius area, unless the Traffic Engineer
8 determines that the area outside of the pedestrian zone is not required to facilitate pedestrian
9 movement; and

10 b. A pedestrian zone at least 6 feet wide with a 4 foot wide pedestrian
11 visual corridor if the sidewalk café is located in the Downtown Urban Center as established in
12 the Comprehensive Plan; or

1 e. ~~If located outside of the Downtown Urban Center as established in the~~
2 ~~Comprehensive Plan, a pedestrian zone at least 5 feet wide with a 3-foot wide pedestrian visual~~
3 ~~corridor; or~~

4 d. ~~A wider pedestrian zone or pedestrian visual corridor may be required~~
5 ~~by the Director of Transportation to provide for pedestrian passage, traffic management, or any~~
6 ~~other public use purpose.~~

7 3. ~~In addition to any other required setback, the proposed sidewalk café shall be~~
8 ~~located at least:~~

9 a. ~~5 feet from alleys, driveways, bus zone areas, disabled person parking~~
10 ~~zones, and commercial loading zones; and~~

11 b. ~~5 feet from curb ramps, parking meters or pay stations, traffic signs,~~
12 ~~utility poles, fire hydrants, bike racks, and other street fixtures; and~~

13 c. ~~10 feet along the curb line from the point where the radius of corner~~
14 ~~curb area intersects the curb line; and~~

15 d. ~~3 feet from the curb; and~~

16 e. ~~50 feet from a lot zoned RSL, SF 5000, SF 7200, SF 9600, LR1, LR2,~~
17 ~~or LR3 as these zoning designations are defined under subsection 23.30.010.A if the abutting~~
18 ~~zoning does not have an RC designation as shown on the Official Land Use Map, Chapter 23.32;~~

19 ~~or~~

20 f. ~~A larger setback distance may be required by the Director of~~
21 ~~Transportation to provide for pedestrian passage, traffic management, or any other public use~~
22 ~~purpose;~~

1 4. ~~The width of the sidewalk café shall not exceed the available pedestrian zone~~
2 ~~width, provided the Director, may allow the sidewalk café to increase in width if the Director~~
3 ~~determines that the pedestrian zone can extend into an adjacent public place closed to vehicular~~
4 ~~travel or a public place plaza;~~

5 5. ~~The applicant shall obtain a Certificate of Approval for the sidewalk café from~~
6 ~~the appropriate Board or Commission when located in a Landmark District or Historic District~~
7 ~~subject to the provisions of Title 23 or 25;~~

8 6. ~~The proposed sidewalk café activity shall not violate the Americans with~~
9 ~~Disabilities Act;~~

10 7. ~~Amplified sound shall not be used in the sidewalk café and the permittee shall~~
11 ~~comply with Chapter 25.08, Noise Control; and~~

12 8. ~~The permittee shall not locate electrical lines overhead or on the ground surface~~
13 ~~where the public has access to the public place.~~

14 B. ~~The Director of Transportation may require additional information from the applicant~~
15 ~~as provided for in Section 15.04.030.~~

16 C. ~~The Director may, as deemed appropriate, condition the sidewalk café Street Use~~
17 ~~permit to address the:~~

18 1. ~~Design standards;~~

19 2. ~~Hours of operation and dates of use;~~

20 3. ~~Impacts associated with the sidewalk café activity from: lighting, noise, or the~~
21 ~~placement of signage, furniture, or equipment;~~

22 4. ~~Posting a surety bond in accordance with the provisions of Section 15.04.044 or~~
23 ~~establishing an escrow account in accordance with the provisions of Section 15.04.042;~~

1 5. ~~Need for repairs or improvements to the public place in order to accommodate~~
2 ~~the sidewalk café or to ensure access to the use complies with the Americans with Disabilities~~
3 ~~Act; or~~

4 6. ~~Pedestrian circulation, traffic management, or any other public use purpose.~~

5 C. ~~The Director of Transportation may promulgate rules to implement Chapter 15.16.~~
6 ~~The rules may address the subjects identified in Section 15.16.040 and other subjects the~~
7 ~~Director believes may aid in the implementation of Chapter 15.16.~~

8 D. ~~Unless expressly authorized by the Director of Transportation pursuant to the Street~~
9 ~~Use permit for a sidewalk café, no public place surface shall be broken or disturbed, and no~~
10 ~~permanent fixture of any kind shall be installed in or on the public place in connection with a~~
11 ~~sidewalk café.~~

12 1. ~~A separate Street Use permit shall be applied for before placing any additional~~
13 ~~item beyond the sidewalk café fencing and may be approved by the Director of Transportation;~~
14 ~~provided the following requirements are met:~~

15 a. ~~Platforms or other site-leveling structures may only be approved if a~~
16 ~~portion of the proposed site area exceeds an 8 percent grade;~~

17 b. ~~Plans for a platform or other structure shall be certified by a registered~~
18 ~~professional engineer; and~~

19 e. ~~Platforms or other structures in the public place shall be continuously~~
20 ~~maintained by the permittee in an as-built condition.))~~

21 A. A café may be located on a public place as defined in Section 15.02.046 including but
22 not limited to a sidewalk, planting strip, curb space, alley, or public plaza. The following

1 requirements apply to all cafés in the public place regardless of location unless otherwise
2 specified.

3 B. The Director of Transportation may issue a Street Use permit authorizing the use of a
4 public place for a café if the following requirements are met:

5 1. The applicant shall be the owner or occupant of the abutting property;

6 2. The café shall abut the applicant's business frontage unless an alternative
7 location is approved;

8 3. The café shall be operated by a food service business holding all necessary City
9 and state permits and licenses;

10 4. The café shall not be located in the public place abutting a lot zoned RSL, SF
11 5000, SF 7200, SF 9600, LR1, LR2, or LR3 as these zoning designations are defined under
12 subsection 23.30.010.A unless the abutting zone has an RC classification as shown on the
13 Official Land Use Map, Chapter 23.32;

14 5. The applicant shall obtain insurance according to Section 15.04.045. Failure to
15 maintain the required insurance coverage is grounds for revoking a Street Use permit for a café
16 in the public place;

17 6. The applicant shall indemnify and hold harmless The City of Seattle
18 according to Section 15.04.060;

19 7. The applicant shall obtain a certificate of approval for the café in the public
20 place from the appropriate Board or Commission when located in a Landmark District or
21 Historic District subject to the provisions of Title 23 or 25; and

22 8. The applicant shall obtain all applicable permits for installing the café and all
23 associated café elements, including but not limited to platforms and other structures. Platforms or

1 other structures may be approved when necessary for site-leveling, accessibility, or any public-
2 use purpose.

3 C. The applicant shall provide public notice of a new application in a form approved by
4 the Director of Transportation as provided for in Section 15.04.030.

5 D. The Director of Transportation may require additional information from the applicant
6 as provided for in Section 15.04.030.

7 E. The Director of Transportation may, as deemed appropriate, condition the Street Use
8 permit to address potential impacts as provided for in Section 15.04.035, including requiring a
9 surety bond in accordance with the provisions of Section 15.04.044 or establishing an escrow
10 account in accordance with the provisions of Section 15.04.042.

11 F. The Director of Transportation may promulgate rules to implement this Chapter 15.16.

12 ~~((15.16.050 Liquor~~

13 ~~Liquor, as defined in RCW 66.04.01024, as now existing or as amended, may only be used or~~
14 ~~sold at a sidewalk café if authorized by: the Street Use permit; the permit issued by the Director~~
15 ~~of Public Health—Seattle & King County; and the permit issued by the Washington State Liquor~~
16 ~~Control Board.))~~

17 **15.16.051 Siting standards**

18 A. All cafés and associated elements located on the sidewalk or where pedestrian
19 mobility is impacted, including but not limited to fencing, seating, tables, platforms, or
20 umbrellas, shall be sited to provide:

21 1. An unobstructed corner clearance zone;

22 2. An unobstructed pedestrian clear zone abutting the entire length of the café;

1 a. The width of the pedestrian clear zone is determined by the street type
2 where the café is located as defined by the Right-of-Way Improvements Manual or successor
3 rule; and

4 b. The width of the café shall not be greater than the available pedestrian
5 clear zone width, except where the Director of Transportation determines the pedestrian clear
6 zone can extend into an adjacent public place that is closed to vehicular travel, a public place
7 plaza, or other public space in consultation with the authorizing official for the space;

8 3. An unobstructed 3-foot-wide pedestrian straight path as defined in Section
9 15.02.046 within the designated pedestrian clear zone that extends along the permitted area and
10 for 25 feet on either end of the permitted area’s boundaries along the block face.

11 B. The café shall comply with clearances required in the Right-of-Way Improvements
12 Manual or successor rule. The café shall not be sited in a manner that adversely affects
13 pedestrian mobility directly beyond the permitted footprint area or inhibits the operation,
14 maintenance, or functionality of any utilities or street fixtures.

15 C. The Traffic Engineer or Director of Transportation has authority to require dimensions
16 greater than the minimum standards included in subsections 15.16.050.A and 15.16.050.B to
17 provide for pedestrian passage, traffic management, or any other public-use purpose.

18 ~~((15.16.060 Insurance~~

19 ~~An applicant for a sidewalk café Street Use permit shall, before issuance of the Street Use~~
20 ~~permit, obtain and maintain in full force and effect at its own expense, commercial general~~
21 ~~liability (CGL) insurance that names the City of Seattle as an additional insured for primary~~
22 ~~limits of liability for the purpose of protecting the City from all claims and risks of loss as a~~
23 ~~result of the permittee’s activity, occupation, operation, maintenance, or use of a public place in~~

1 ~~conjunction with the permitted activity. The CGL insurance shall be in an amount specified by~~
2 ~~the Director of Transportation and shall include: premises operations, products and completed~~
3 ~~operations, broad form property damage liability, and personal injury. Failure to maintain the~~
4 ~~required CGL insurance coverage is grounds for sidewalk café Street Use permit revocation.))~~

5 **~~15.16.070 Indemnity~~**

6 The permittee shall agree to defend, indemnify, and hold harmless the City of Seattle, its
7 officials, officers, employees, and agents against:

8 A. ~~Any liability, claims, causes of action, judgments, or expenses, including reasonable~~
9 ~~attorney fees, resulting directly or indirectly from any act or omission of the permittee, its~~
10 ~~subcontractors, anyone directly or indirectly employed by them, and anyone for whose acts or~~
11 ~~omissions they may be liable, arising out of the permittee's use or occupancy of the public place;~~
12 and

13 B. ~~All loss by the failure of the permittee to fully or adequately perform, in any respect,~~
14 ~~all authorizations of obligations under the sidewalk café Street Use permit.~~

15 **~~15.16.075 Public notice of application~~**

16 A. ~~A sidewalk café Street Use permit applicant shall post notice of a new application for~~
17 ~~a sidewalk café at the proposed site. The notice shall be clearly visible from the abutting~~
18 ~~sidewalk.~~

19 B. ~~The notice of application shall be on a form approved by the Department of~~
20 ~~Transportation and shall state that written comments shall be postmarked or emailed to the~~
21 ~~Director of Transportation no later than ten business days after the first day of the posted public~~
22 ~~notice.~~

1 ~~C. A sidewalk café Street Use permit for which notice is required shall not be issued by~~
2 ~~the Director of Transportation until after the notice of application comment period has ended.))~~

3 **15.16.080 ((Maintaining public place conditions)) Permittee responsibilities for café**
4 **operation**

5 A. The permittee shall maintain the ((sidewalk)) café and adjoining and abutting public
6 place free of all refuse of any kind generated from the operation of the ((sidewalk)) café and their
7 business.

8 B. The café activity shall not violate the Americans with Disabilities Act.

9 C. Amplified sound shall not be used in the café and the permittee shall comply with
10 Chapter 25.08.

11 D. Unless authorized by Street Use permit, the permittee shall not locate electrical lines
12 overhead or on the ground surface where the public has access to the public place.

13 E. Unless authorized by the Director of Transportation pursuant to a Street Use permit, no
14 public place surface shall be broken or disturbed, and no permanent fixture of any kind shall be
15 installed in or on the public place in connection with a café.

16 F. Approved platforms or other site-leveling structures in the public place associated with
17 the café shall be continuously maintained by the permittee in an as-built condition.

18 ((B)) G. Only materials and supplies used by the permittee for the daily operation of the
19 ((sidewalk)) café may be located within the sidewalk café and the permittee shall not store other
20 supplies or other materials in the ((sidewalk)) café or public place unless otherwise authorized by
21 Street Use permit.

22 ~~((C. The surface of the public place shall not be altered and fixtures of any kind shall not~~
23 ~~be installed in the public place unless authorized by a Street Use permit.~~

1 ~~D~~) H. A ~~((sidewalk))~~ café shall not be secured to any public amenity unless authorized
2 by a Street Use permit.

3 ~~(E)~~) I. The permittee shall temporarily remove the ~~((sidewalk))~~ café and clear the public
4 place as the Director of Transportation deems necessary to temporarily accommodate access to
5 abutting properties or utilities.

6 ~~(F)~~) J. The permittee is responsible for ensuring that the ~~((sidewalk))~~ café activity does
7 not ~~((encroach into the roadway or))~~ cause pedestrians to divert from the pedestrian clear zone.

8 ~~(G)~~) K. The permittee shall not operate the ~~((sidewalk))~~ café in a way that restricts or
9 interferes with access to or egress from the abutting property; or creates a nuisance or hazard to
10 public health, safety, or welfare; or increases traffic congestion or delay; or constitutes an
11 obstruction for fire, police, or sanitation vehicles.

12 ~~(H)~~) L. The permittee shall immediately remove the ~~((sidewalk))~~ café when ordered by
13 the Director of Transportation, the Chief of Police, the Fire Chief, or other City official.

14 M. Liquor, as defined in RCW 66.04.010, as now existing or as amended, may only be
15 used or sold at a café if authorized by: the Street Use permit; the permit issued by the Director of
16 Public Health—Seattle & King County; and the permit issued by the Washington State Liquor
17 and Cannabis Board.

18 Section 9. Section 15.17.005 of the Seattle Municipal Code, last amended by Ordinance
19 124261, is amended as follows:

20 **15.17.005 Authorized vending in public places**

21 No person shall vend to the public in a public place unless authorized below:

22 A. The permittee's activity occurs in an area that is permitted for that type of an activity,
23 for example: Chapter 11.25, parade permits; Chapters 15.08 and 15.16, areaway or ~~((sidewalk))~~

1 café Street Use permits; street areas within the Pike Place Market Historical District (Chapter
2 25.24) that are being administered by the Pike Place Market Preservation and Development
3 Authority; Chapter 15.35, filming permits; Chapter 15.52, Special Event permits; or Chapter
4 6.310, Taxicabs and For-Hire Vehicles; or

5 B. The permittee has obtained a Street Use permit authorized by ~~((Sections 15.17.080,~~
6 ~~15.17.100, 15.17.120, 15.17.130, 15.17.150, or 15.17.200))~~ Chapter 15.17; or

7 C. The vendor is vending ~~((newspapers, magazines, event programs, and other similar))~~
8 publications ~~((on-foot,))~~ as authorized by Chapter 15.14 ~~((;))~~ or expressive items protected under
9 the United States or Washington Constitution; or

10 D. The vendor is vending bicycles, helmets, or other bike-share-related merchandise that
11 is made available for general public use and has been authorized by a separate permit.

12 Section 10. Section 15.17.006 of the Seattle Municipal Code, enacted by Ordinance
13 123659, is amended as follows:

14 **15.17.006 Permit expiration, renewal, administration, and revocation**

15 A. A Street Use permit for vending or merchandise display expires if: the business, food
16 vehicle, or vending cart changes ownership; the Street Use permit duration expires; or Street Use
17 permit fees are not paid as required by subsection ~~((15.04.074.B))~~ 15.04.074.D. All carts,
18 objects, or other Street Use permit-related encroachments shall be removed from the public
19 place when the Street Use permit expires. A Street Use permit to vend or display merchandise
20 shall not be ~~((transferrable))~~ transferable or assignable.

21 * * *

22 F. ~~((The Director of Transportation may modify the conditions of a vending or~~
23 ~~merchandise display Street Use permit, including permitted hours or days of operation, after~~

1 ~~providing the permittee with written notice ten calendar days before modifying the Street Use~~
2 ~~permit. A copy of the modified Street Use permit shall be mailed by first class mail to the~~
3 ~~permittee at the address listed on the Street Use permit. The permittee may request a Director's~~
4 ~~review of the decision to modify the conditions of the Street Use permit as provided for in~~
5 ~~Section 15.04.112.~~

6 G.) All vending or merchandise display Street Use permits authorized by Chapter 15.17
7 are of a temporary nature, vest no permanent rights, and are revocable and modifiable as
8 provided for in Section 15.04.070. The Director of Transportation may suspend any vending or
9 merchandise display Street Use permit to: promote transportation mobility or public safety; ((or))
10 coordinate with permitted Special Events authorized by Chapter 15.52, parade permits
11 authorized by Chapter 11.25, or any other permitted activity; or((s)) provide access to property if
12 an access affidavit is withdrawn by the property owner.

13 Section 11. Section 15.17.007 of the Seattle Municipal Code, enacted by Ordinance
14 123659, is amended as follows:

15 **15.17.007 Insurance**

16 ((A. An applicant for a vending or merchandise display Street Use permit shall, before
17 issuance of the Street Use permit, obtain and maintain in full force and effect, at its own expense,
18 commercial general liability (CGL) insurance that names the City of Seattle as an additional
19 insured for primary limits of liability for the purpose of protecting the City from all claims and
20 risks of loss as a result of the permittee's activity, occupation, operation, maintenance, or use of a
21 public place in conjunction with the permitted activity. The CGL insurance shall be in an amount
22 specified by the Director of Transportation and shall include: premises operations; products and
23 completed operations; broad form property damage liability; and personal injury. Failure to

1 maintain the required CGL insurance coverage is grounds for vending or merchandise display
2 Street Use permit revocation.

3 B. A property owner or public entity applicant for a temporary curb space food vehicle
4 vending Street Use permit, as authorized in subsection 15.17.120.D, shall submit a copy of the
5 vendor's CGL insurance as required in subsection 15.17.007.A.)

6 An applicant for a vending or merchandise display Street Use permit shall, before a Street Use
7 permit is issued, obtain insurance according to Section 15.04.045. Failure to maintain the
8 required insurance coverage is grounds for revoking a vending or merchandise display Street Use
9 permit.

10 Section 12. Section 15.17.008 of the Seattle Municipal Code, enacted by Ordinance
11 123659, is amended as follows:

12 **15.17.008 Indemnity**

13 ((The permittee shall agree to defend, indemnify, and hold harmless the City of Seattle, its
14 officials, officers, employees, and agents against:

15 A. Any liability, claims, causes of action, judgments, or expenses, including reasonable
16 attorney fees, resulting directly or indirectly from any act or omission of the permittee, its
17 subcontractors, anyone directly or indirectly employed by them, and anyone for whose acts or
18 omissions they may be liable, arising out of the permittee's use or occupancy of the public place;
19 and

20 B. All loss by the failure of the permittee to fully or adequately perform, in any respect,
21 all authorizations of obligations under the vending or merchandise display Street Use permit.))

22 The permittee shall indemnify and hold harmless The City of Seattle according to Section
23 15.04.060.

1 Section 13. Section 15.17.009 of the Seattle Municipal Code, enacted by Ordinance
2 123659, is amended as follows:

3 **15.17.009 Public notice of application**

4 ~~((A. The vending Street Use permit applicant shall send notice of an application for a
5 vending site by first class mail to:~~

6 ~~1. All street level business entities, public entities, and residences located:~~

7 ~~a. Within a 100-foot radius of the vending site, and~~

8 ~~b. On the adjacent and opposing block face of the vending site, and~~

9 ~~c. On the adjoining block face around the corner if the vending site is~~

10 ~~located within 10 feet of a corner curb radius area.~~

11 ~~2. The property manager, home owners association, or apartment manager of all~~

12 ~~residential units located above:~~

13 ~~a. The adjacent and opposing block face of the proposed vending site, and~~

14 ~~b. On the adjoining block face around the corner if the vending site is~~

15 ~~located within 10 feet of a corner curb radius area.~~

16 ~~B. The applicant shall send all required notices three calendar days before the start of the
17 public notice period.~~

18 ~~C. Notice of application is not required if: a permittee with an existing vending Street Use
19 permit applies to renew the same type of vending Street Use permit for the same vending site, or
20 the stadium and exhibition center event site has already been designated or permitted by the
21 Director of Transportation.~~

22 ~~D. The notice of application shall be on a form approved by the Department of
23 Transportation.~~

1 ~~E. Written comments concerning the application shall be postmarked or emailed to the~~
2 ~~Director of Transportation no later than ten business days after the first day of the public notice~~
3 ~~period.~~

4 ~~F. The applicant shall provide the notice of application required by subsection~~
5 ~~15.17.009.A once the Director of Transportation has accepted an application as complete. The~~
6 ~~applicant shall provide the Director of Transportation with a mailing list containing: the~~
7 ~~individuals the notice was mailed to, the recipient's mailing address, and date the notice was~~
8 ~~mailed to each recipient.~~

9 ~~G. The Director of Transportation shall provide a notice to the public before designating~~
10 ~~a food vehicle zone, stadium exhibition center event site, or other City designated vending site.~~

11 ~~H. A vending Street Use permit for which notice is required shall not be issued until a~~
12 ~~complete mailing list has been received by the Director of Transportation and the notice of~~
13 ~~application comment period has ended.)~~

14 A vending Street Use permit applicant shall provide public notice of a new application in a form
15 approved by the Director of Transportation as provided for in Section 15.04.030. A vending
16 Street Use permit shall not be issued by the Director of Transportation until after the public
17 notice period has ended.

18 Section 14. Section 15.17.100 of the Seattle Municipal Code, last amended by Ordinance
19 123668, is amended as follows:

20 **15.17.100 Food and flower vending from a public place sidewalk or plaza**

21 A. The Director of Transportation may issue a Street Use permit authorizing the use of a
22 public place sidewalk or plaza for ((;)) vending food, flowers, or nonalcoholic beverages from a
23 vending cart ((as depicted in Exhibit A for 15.17.100: Vending Cart Location; or)) , a food

1 vehicle stationed at an authorized public place plaza site ((;)) , or ((from)) an attended newsstand
2 under the following requirements:

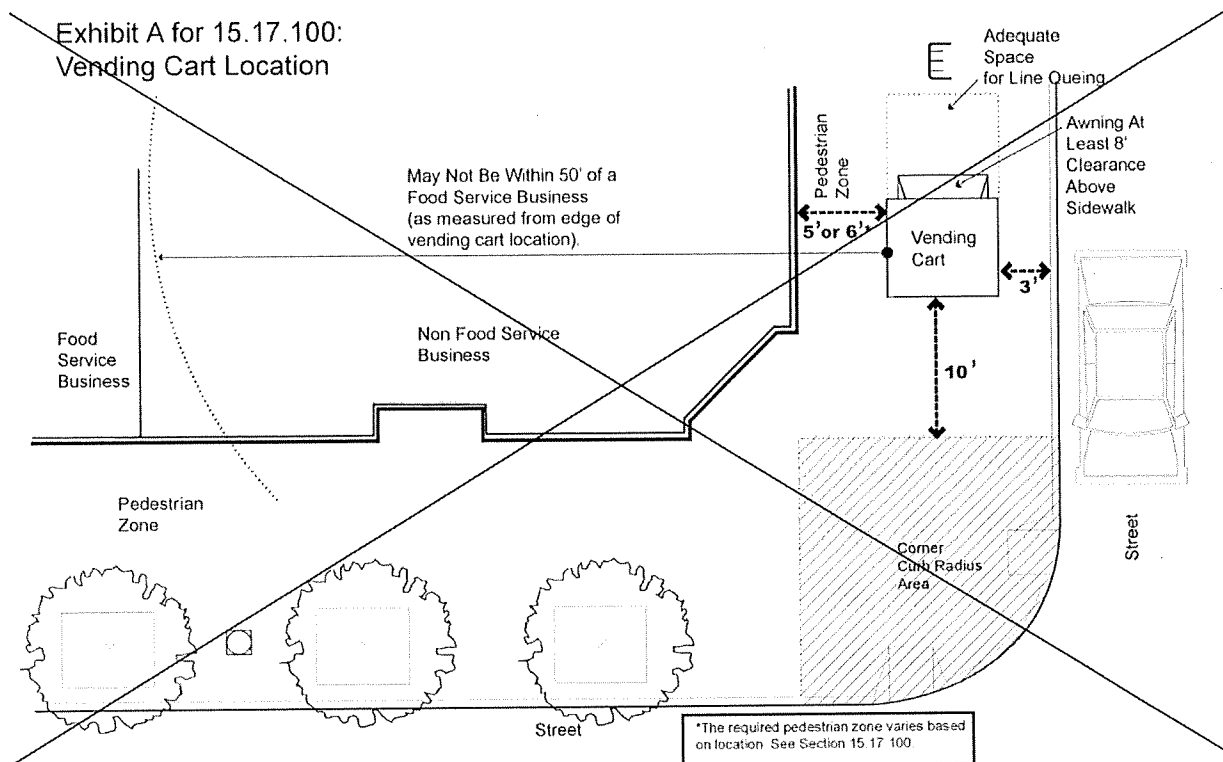

- 3
- 4 1. The permittee shall comply with all ((;)) requirements established by Public
- 5 Health—Seattle & King County ((code requirements)), the King County Board of Health, and
- 6 the Seattle Fire Department ((requirements)) if propane or a combustible fuel is used;
- 7 2. The permittee shall only sell food and beverages that are capable of immediate
- 8 consumption;
- 9 3. The permittee shall obtain and maintain in effect all required permits and
- 10 business licenses and display the vending Street Use permit at the vending site in a manner
- 11 approved by the Director of Transportation;
- 12 4. The permittee's vending cart or food vehicle shall not be located in the public
- 13 place abutting a lot zoned RSL, SF 5000, SF 7200, SF 9600, LR1, LR2, or LR3 as these zoning

1 designations are defined under subsection 23.30.010.A if the abutting zoning does not have an
2 RC (~~(designation)~~) classification as shown on the Official Land Use Map, Chapter 23.32;

3 5. The permittee's vending cart or food vehicle shall not be located in the curb
4 space of the public place, unless authorized under Section 15.17.120;

5 6. (~~As depicted in Exhibit A for 15.02.046: Pedestrian Zone/Pedestrian Visual~~
6 ~~Corridor; a)~~ A proposed vending cart, food vehicle, or attended newsstand, and all associated
7 vending activity (~~(including customer queues, accessory units, or signage;)~~) shall not impair
8 pedestrian passage and shall be sited to provide:

9 a. An unobstructed (~~(corner curb radius area)~~) corner clearance zone;
10 (~~and~~)

11 (~~b. If located in the Downtown Urban Center as established in the~~
12 ~~Comprehensive Plan, a pedestrian zone at least 6 feet wide with a 4-foot-wide pedestrian visual~~
13 ~~corridor; or~~

14 ~~c. If located outside of the Downtown Urban Center as established in the~~
15 ~~Comprehensive Plan, a pedestrian zone at least 5 feet wide with a 3-foot-wide pedestrian visual~~
16 ~~corridor; or)~~

17 b. An unobstructed pedestrian clear zone abutting the entire length of the
18 vending cart, food vehicle, or attended newsstand. The width of the pedestrian clear zone is
19 determined by the street type where the permitted area is located as defined by the Right-of-Way
20 Improvements Manual or successor rule; and

21 c. An unobstructed 3-foot-wide pedestrian straight path as defined in
22 Section 15.02.046 within the designated pedestrian clear zone that extends along the permitted
23 area and for 25 feet on either end of the permitted area's boundaries along the block face;

1 ~~((6. In addition to any other required setbacks, the vending cart, food vehicle, or~~
2 ~~attended newsstand site shall be located at least:~~

3 ~~a. 3 feet from the curb; and~~

4 ~~b. 5 feet from alleys, driveways, bus zone areas, disabled person parking~~
5 ~~zones, food vehicle zones, and commercial loading zones; and~~

6 ~~c. 5 feet from curb ramps, parking meters or pay stations, traffic signs,~~
7 ~~utility poles, fire hydrants, bike racks, and other street fixtures; and~~

8 ~~d. 10 feet along the curb line from the point where the radius of corner~~
9 ~~curb area intersects the curb line; and~~

10 ~~e. 15 feet from any business entrance or exit; and~~

11 ~~f. 50 feet from a food service business if the permittee is vending food or~~
12 ~~nonalcoholic beverages and at least 50 feet from a floral business if the permittee is vending~~
13 ~~flowers. A vending Street Use permit may, however, be issued to the owner of a food service~~
14 ~~business for a site along the food service business's frontage provided, all other Chapter 15.17~~
15 ~~vending requirements are satisfied; and~~

16 ~~g. 1,000 feet from any public or private school containing a 9-12 class if~~
17 ~~the permittee's vending cart or food vehicle is located in a public place abutting a lot listed in~~
18 ~~subsection 15.17.100.A.4.~~

19 ~~7. A larger setback distance may be required by the Director of Transportation to~~
20 ~~provide for pedestrian passage, traffic management, or any other public use purpose;))~~

21 7. The vending cart, food vehicle, or attended newsstand shall comply with
22 clearances required in the Right-of-Way Improvements Manual or successor rule. In addition to
23 any other required setbacks, the vending cart, food vehicle, or attended newsstand:

1 9. Vending sites shall not be located in driveways or within 15 feet of a business
2 entrance or exit unless the abutting property owner submits an affidavit stating that access is not
3 needed during the proposed vending hours;

4 ~~((9))~~ 10. The ~~((proposed))~~ vending activity shall not violate the Americans with
5 Disabilities Act;

6 ~~((10))~~ 11. The permittee shall not use amplification or noise-making devices and
7 the permittee shall comply with Chapter 25.08~~((, Noise Control))~~;

8 ~~((11. The))~~ 12. Unless specifically authorized by Street Use permit, the permittee
9 shall not locate electrical lines overhead or on the ground surface where the public has access to
10 the public place; and

11 ~~((12))~~ 13. The permittee shall not leave a vending cart or food vehicle unattended
12 in the public place for longer than 30 minutes.

13 * * *

14 D. The Director of Transportation may, as deemed appropriate, condition the vending
15 cart or food vehicle Street Use permit to address ~~((the:~~

16 1. ~~Design and placement of food vending equipment and umbrellas;~~
17 2. ~~Hours of operation and dates of use;~~
18 3. ~~Need for repairs or improvements to the public place in order to accommodate~~
19 ~~the vending activity or to ensure access to the use complies with the Americans with Disabilities~~
20 ~~Act;~~

21 4. ~~Impacts associated with the vending activity from: lighting, noise, emissions to~~
22 ~~the air, the placement of signage, or equipment such as generators;~~

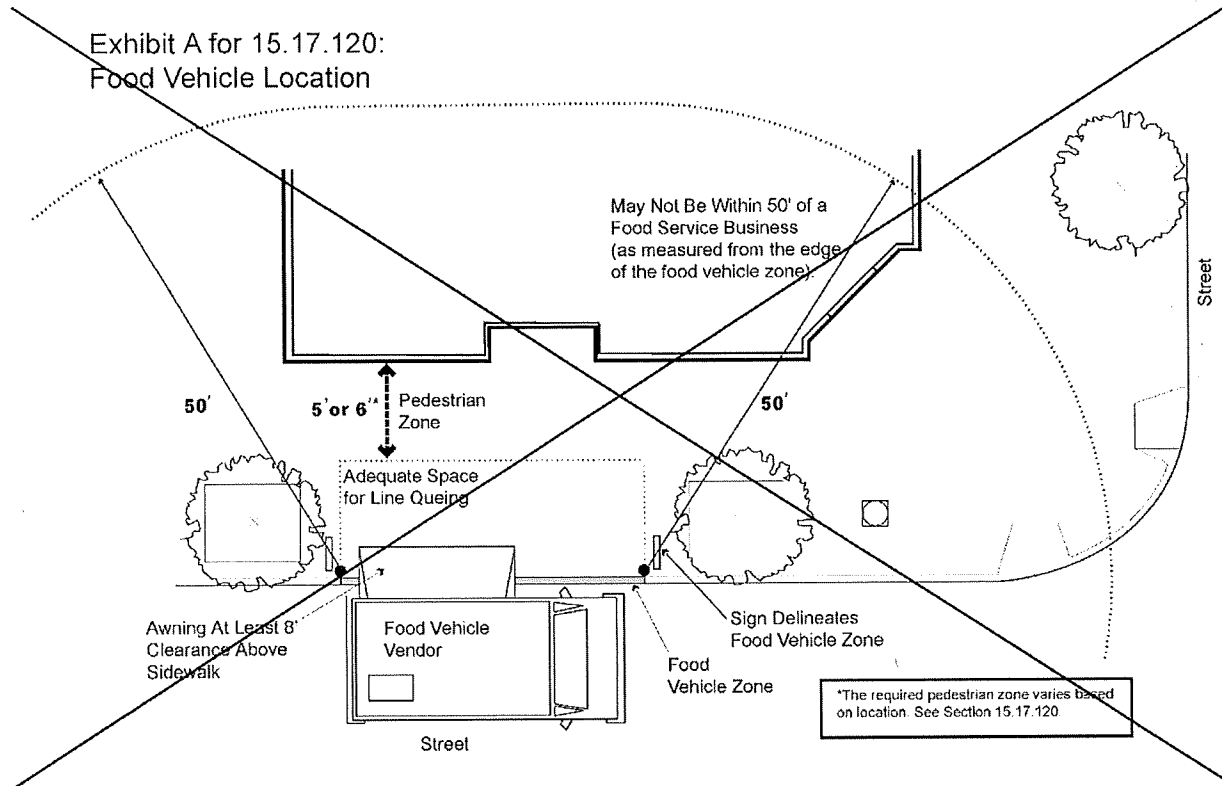

1

2

1. Vending shall only occur from a curb space if the vending has been authorized

3

by a:

4

a. Food-vehicle-zone vending Street Use permit that allows vending if the curb space is delineated by a sign or other traffic control device as a food-vehicle zone ((~~7~~)) ; or

6

b. Temporary-curb-space vending Street Use permit that allows vending from a curb space the Director of Transportation has approved for a vending activity that shall only occur in conjunction with an event located on private property abutting the curb space or an event occurring in the public place;

10

2. The permittee shall comply with all requirements established by Public Health—Seattle & King County ((~~requirements~~)) , the King County Board of Health, and the Seattle Fire Department ((~~requirements~~)) if propane or a combustible fuel is used;

12

1 3. The permittee shall only sell food and beverages that are capable of immediate
2 consumption;

3 4. The permittee shall obtain and maintain in effect all required permits and
4 business licenses and display the food-vehicle zone or temporary-curb-space vending Street Use
5 permit at the vending site in a manner approved by the Director of Transportation;

6 5. ~~((As depicted in Exhibit A for 15.02.046: Pedestrian Zone/Pedestrian Visual~~
7 ~~Corridor; a))~~ A food vehicle and all associated vending activity ~~((including customer queues,~~
8 ~~accessory units, or signage;))~~ shall not impair pedestrian passage and shall be sited to provide:

9 ~~((a. If located in the Downtown Urban Center as established in the~~
10 ~~Comprehensive Plan, a pedestrian zone at least 6 feet wide with a 4-foot wide pedestrian visual~~
11 ~~corridor; or~~

12 ~~b. If located outside of the Downtown Urban Center as established in the~~
13 ~~Comprehensive Plan, a pedestrian zone at least 5 feet wide with a 3-foot wide pedestrian visual~~
14 ~~corridor; or))~~

15 a. An unobstructed pedestrian clear zone along the entire length of the
16 permitted area. The width of the pedestrian clear zone is determined by the street type where the
17 permitted area is located as defined by the Right-of-Way Improvements Manual or successor
18 rule; and

19 b. An unobstructed 3-foot-wide pedestrian straight path as defined in
20 Section 15.02.046 within the designated pedestrian clear zone that extends along the permitted
21 area and for 25 feet on either end of the permitted area's boundaries along the block face;

22 6. The food vehicle and associated activities shall comply with clearances
23 required in the Right-of-Way Improvements Manual or successor rule. The food vehicle and

1 associated activities shall not be sited in a manner that adversely affects pedestrian mobility
2 directly beyond the permitted footprint area or inhibits the operation, maintenance, or
3 functionality of any utilities or street fixtures;

4 7. The Traffic Engineer or Director of Transportation has authority to require
5 dimensions greater than the minimum standards included in subsections 15.17.120.A.5 and
6 15.17.120.A.6 to provide for pedestrian passage, traffic management, or any other public-use
7 purpose;

8 ((6)) 8. Food-vehicle-zone vending and temporary-curb-space vending Street Use
9 permit vending sites shall not be located in driveways((7)) or loading zones, or within 15 feet of a
10 business entrance or exit;

11 ((7)) 9. The ((proposed)) vending activity shall not violate the Americans with
12 Disabilities Act;

13 ((8)) 10. The permittee shall not use amplification or noise-making devices and
14 the permittee shall comply with Chapter 25.08((9-Noise Control));

15 ((9-The)) 11. Unless authorized by Street Use permit, the permittee shall not
16 locate electrical lines overhead or on the ground surface where the public has access to the public
17 place; and

18 ((10)) 12. The vending shall only occur from the side of a food vehicle that is
19 parked abutting and parallel to the curb.

20 * * *

21 C. The Seattle Department of Transportation may designate a food-vehicle zone subject
22 to the following requirements:

1 1. The proposed location is:

2 a. At least 50 feet from a food service business when vending food or
3 nonalcoholic beverages; ~~((and))~~

4 b. Not located in the public place abutting a lot zoned RSL, SF 5000, SF
5 7200, SF 9600, LR1, LR2, or LR3 as these zoning designations are defined under subsection
6 23.30.010.A if the abutting zoning does not have an RC ~~((designation))~~ classification as shown
7 on the Official Land Use Map, Chapter 23.32; and

8 c. At least 1,000 feet from any public or private school containing a ~~((9-~~
9 ~~12))~~ ninth- to twelfth-grade class ~~((if the permittee's food vehicle is located in a public place~~
10 ~~abutting a lot listed in subsection 15.17.120.C.1.b.-))~~ ; and

11 2. If an existing food-vehicle zone conflicts with the setback requirements of
12 subsection 15.17.120.C.1, the Director of Transportation shall not issue a new food-vehicle-zone
13 vending Street Use permit when the existing Street Use permit expires.

14 D. The Director of Transportation may issue to a vendor, property owner, or public
15 entity ~~((;))~~ a temporary-curb-space vending Street Use permit that~~((;))~~ authorizes vending from a
16 curb space that is not designated as a food-vehicle zone~~((, and is effective))~~ . The permit shall be
17 effective for no more than four days during a six-month period ~~((for the adjoining address in))~~ if
18 the curb space abuts a lot with a zoning designation other than those listed in subsection
19 15.17.120.C.1.b, or ~~((is))~~ it shall be effective for no more than one day during a calendar year for
20 the block ~~((abutting))~~ that abuts a lot with a zoning designation listed in subsection
21 15.17.120.C.1.b. The temporary-curb-space vending Street Use permit may be issued under the
22 following requirements:

1 1. The permittee shall reserve the curb space as required in Title 11(~~(, Vehicles~~
2 ~~and Traffic)~~);

3 2. The permittee shall comply with the requirements in (~~(subsections)~~) subsection
4 15.17.120.A;

5 3. The temporary-curb-space vending Street Use permit shall only be issued for
6 an event located on private property abutting the curb space or an event located in the adjoining
7 public place. If the event requires a Special Event as permitted and authorized under Chapter
8 15.52, (~~(Special Event permits,)~~) the Director of Transportation shall not issue a temporary-curb-
9 space vending Street Use permit; and

10 4. (~~(If)~~) The vending activity shall end by 10 p.m. if located in the public place
11 abutting a lot zoned RSL, SF 5000, SF 7200, SF 9600, LR1, LR2, or LR3 as these zoning
12 designations are defined under subsection 23.30.010.A if the abutting zoning does not have an
13 RC (~~(designation)~~) classification as shown on the Official Land Use Map, Chapter 23.32(~~(;the~~
14 ~~vending activity shall end by 10:00 p.m)~~).

15 E. The Director of Transportation may require additional information from the applicant
16 as provided for in Section 15.04.030.

17 F. The Director of Transportation may, as deemed appropriate, condition the food-vehicle
18 zone or temporary-curb-space vending Street Use permit to address (~~(the:~~

19 1. ~~Design and placement of food vending equipment and umbrellas;~~

20 2. ~~Hours of operation and dates of use;~~

21 3. ~~Need for repairs or improvements to the public place in order to accommodate~~
22 ~~the vending activity or to ensure access to the use complies with the Americans with Disabilities~~
23 ~~Act;~~

1 3. Mobile-food ((-)) vending permittees shall comply with all applicable
2 requirements of Title 5 of the Code of the King County Board of Health;

3 4. Mobile-food ((-)) vending ~~((permittees))~~ permittees shall obtain and maintain in
4 effect all required permits and business licenses and display the mobile-food vending Street Use
5 permit on the vending cart or food vehicle in a manner approved by the Director of
6 Transportation;

7 5. Mobile-food ((-)) vending permittees shall comply with Chapter 25.08~~((, Noise~~
8 ~~Control))~~);

9 6. Tables, carts, umbrellas, or other vending-related installations shall not be
10 erected in the public place in association with a mobile-food vending activity;

11 7. The mobile-food vending activity shall not violate the Americans with
12 Disabilities Act;

13 ~~((7. As depicted in Exhibit A for 15.02.046: Pedestrian Zone/Pedestrian Visual~~
14 ~~Corridor, a))~~

15 8. A vending cart or food vehicle and all associated mobile-food vending activity
16 ~~((including customer queues))~~ shall ~~((not))~~ neither impair pedestrian passage nor inhibit the
17 operation, maintenance, or functionality of any utilities or street fixtures; ~~((and shall be sited to~~
18 ~~provide a pedestrian zone at least 5 feet wide with a 3-foot wide pedestrian visual corridor.))~~

19 9. Mobile vending carts and food vehicles not located in the curb space shall be
20 sited to provide:

21 a. An unobstructed corner clearance zone; and

22 b. Appropriate clearances as required in the Right-of-Way Improvements
23 Manual or successor rule, or any other applicable rule.

* * *

1
2 ((C)) D. The Director of Transportation may require additional information from the
3 applicant as provided for in Section 15.04.030.

4 ((D)) E. The Director of Transportation may, as deemed appropriate, condition the
5 mobile-food vending Street Use permit to address ((the:

6 1. Hours of operation and dates of use;

7 2. Impacts associated with the vending activity from: lighting, noise, or emissions
8 to the air; or

9 3. Pedestrian circulation, traffic management, or any other public use purpose))
10 potential impacts as provided for in Section 15.04.035.

11 Section 17. Section 15.17.150 of the Seattle Municipal Code, last amended by Ordinance
12 123659, is amended as follows:

13 **15.17.150 Merchandise display from a public place**

14 A. The Director of Transportation may issue a merchandise display Street Use permit to a
15 retail sales business allowing the same goods or wares offered for sale by the business to be
16 displayed on the adjoining public place. Merchandise displays shall be subject to the following
17 requirements: ((as depicted in Exhibit A for 15.17.150: Merchandise Display Location:))

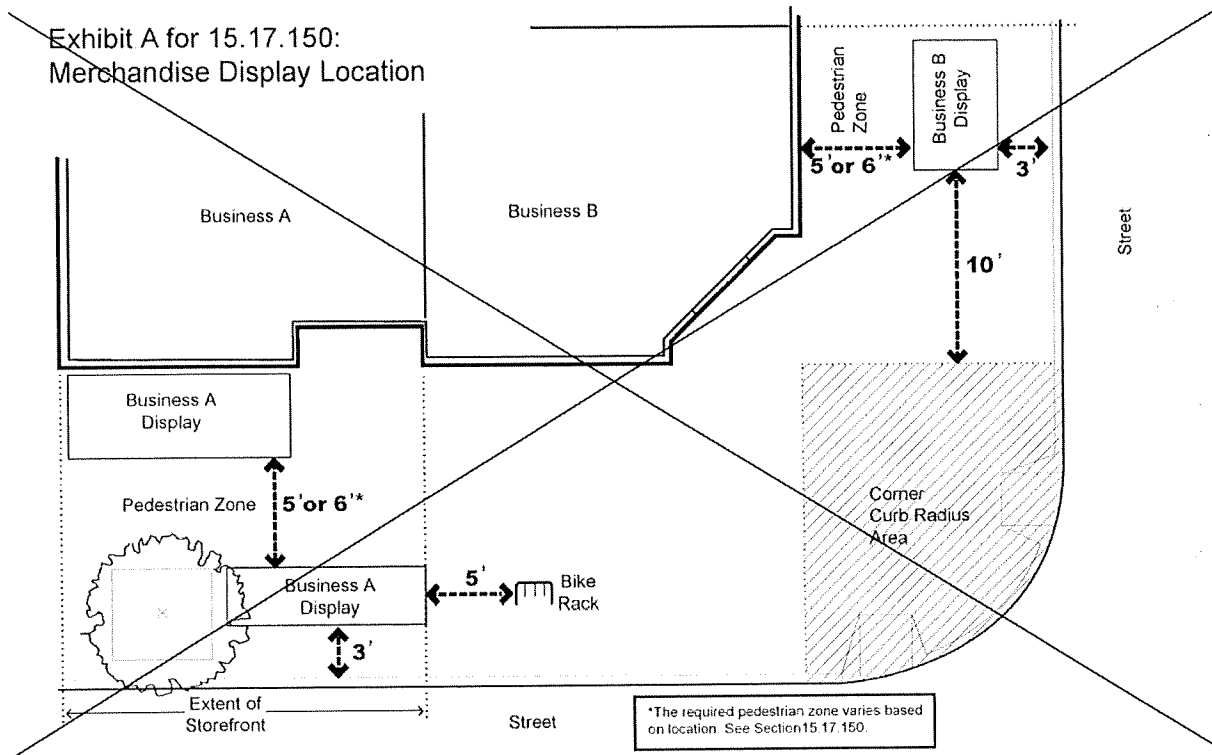

1
2
3
4
5
6
7
8
9
10
11
12
13

1. ((As depicted in Exhibit A for 15.02.046: Pedestrian Zone/Pedestrian Visual Corridor, the)) The proposed merchandise display shall be sited to provide:
- a. An unobstructed ((corner curb radius area)) corner clearance zone;
 - ((and))
 - ((b. If located in the Downtown Urban Center as established in the Comprehensive Plan, a pedestrian zone at least 6-foot wide with a 4-foot wide pedestrian visual corridor; or
 - e. If located outside of the Downtown Urban Center as established in the Comprehensive Plan, a pedestrian zone at least 5-foot wide with a 3-foot wide pedestrian visual corridor; or))
 - b. An unobstructed pedestrian clear zone abutting the entire length of the merchandise display. The width of the pedestrian clear zone is determined by the street type

1 where the merchandise display is located as defined by the Right-of-Way Improvements Manual
2 or successor rule; and

3 c. An unobstructed 3-foot-wide pedestrian straight path as defined in
4 Section 15.02.046 within the designated pedestrian clear zone that extends along the permitted
5 area and for 25 feet on either end of the permitted area's boundaries along the block face;

6 2. ((~~In addition to any other required setbacks, the merchandise display site shall~~
7 ~~be located at least:~~

8 a. ~~3 feet from the curb; and~~

9 b. ~~5 feet from alleys, driveways, bus zone areas, parking zones for~~
10 ~~disabled persons, food vehicle zones, and commercial loading zones; and .~~

11 c. ~~5 feet from curb ramps, parking meters or pay stations, traffic signs,~~
12 ~~utility poles, fire hydrants, bike racks, and other street fixtures; and~~

13 d. ~~10 feet along the curb line from the point where the radius of corner~~
14 ~~curb area intersects the curb line; or~~

15 e. ~~A larger setback distance may be required by the Director of Transportation to~~
16 ~~provide for pedestrian passage, traffic management, or for any other public use purpose;)) The~~

17 merchandise display shall comply with clearances required in the Right-of-Way Improvements
18 Manual or successor rule. In addition to any other required setbacks, the merchandise display:

19 a. Shall not be sited in a manner that adversely affects pedestrian mobility
20 directly beyond the permitted footprint area or inhibits the operation, maintenance, or
21 functionality of any utilities or street fixtures;

1 b. Shall not be located in the furniture zone when the curb space is
2 designated as a bus zone area, disabled person parking zone, food-vehicle zone, or commercial
3 loading zone;

4 c. Shall be located:

5 1) At least 10 feet from the corner clearance zone when located in
6 the furniture zone; and

7 2) At least 5 feet from curb ramps, curb ramp landings, alleys, and
8 driveways;

9 3. The Traffic Engineer or Director of Transportation has authority to require
10 dimensions greater than the minimum standards included in subsections 15.17.150.A.1 and
11 15.17.150.A.2 to provide for pedestrian passage, traffic management, or any other public-use
12 purpose.

13 4. The merchandise display shall not be located in the public place abutting a lot
14 zoned RSL, SF 5000, SF 7200, SF 9600, LR1, LR2, or LR3 as these zoning designations are
15 defined under subsection 23.30.010.A if the abutting zoning does not have an RC ~~((designation))~~
16 classification as shown on the Official Land Use Map, Chapter 23.32;

17 ~~((4))~~ 5. The display shall be removed during those hours that the business is
18 closed;

19 ~~((5))~~ 6. The ~~((proposed))~~ merchandise display activity shall not violate the
20 Americans with Disabilities Act;

21 ~~((6))~~ 7. Sales of goods or merchandise displayed shall occur on the adjoining
22 privately owned property;

1 ~~((7))~~ 8. The display shall not contain alcoholic beverages, tobacco, firearms or
2 munitions, any article that a minor is prohibited by law from purchasing, or any material
3 restricted by the Fire Code from direct access or handling by the public;

4 ~~((8))~~ 9. The permittee shall not use amplification or noise-making devices, and the
5 permittee shall comply with Chapter 25.08~~((, Noise Control))~~; and

6 ~~((9. The))~~ 10. Unless specifically authorized by Street Use permit, the permittee
7 shall not locate electrical lines overhead or on the ground surface where the public has access to
8 the public place.

9 B. The City assumes no responsibility for loss of the items on display, whether the loss
10 occurs through accident, collision, vandalism, theft, or otherwise.

11 C. The Director of Transportation may require additional information from the applicant
12 as provided for in Section 15.04.030.

13 D. The Director of Transportation may, as deemed appropriate, condition the
14 merchandise display Street Use permit to address ~~((the:~~

15 ~~1. Design and placement of merchandise display equipment and umbrellas;~~

16 ~~2. Hours of operation and dates of use;~~

17 ~~3. Need for repairs or improvements to the public place in order to accommodate~~
18 ~~the vending activity or to ensure access to the use complies with the Americans with Disabilities~~
19 ~~Act;~~

20 ~~4. Impacts associated with the merchandise display activity from: lighting, noise,~~
21 ~~emissions to the air, the placement of signage, or equipment such as generators; and~~

22 ~~5. Pedestrian circulation, traffic management, or any other public use purpose))~~
23 potential impacts as provided for in Section 15.04.035.

1 Section 18. Section 15.17.152 of the Seattle Municipal Code, last amended by Ordinance
2 123659, is amended as follows:

3 **15.17.152 Maintaining public place conditions**

4 * * *

5 F. The permittee is responsible for ensuring that customer queues, displays, or vending
6 activity do not encroach into the roadway ((;)) or cause pedestrians to divert from the abutting
7 pedestrian clear zone.

8 * * *

9 Section 19. Section 15.17.200 of the Seattle Municipal Code, last amended by Ordinance
10 123659, is amended as follows:

11 **15.17.200 ((Vending by nonprofit organizations)) First Amendment vending**

12 The Director of Transportation, the Superintendent of the Parks Department, and the Director of
13 the Seattle Center are authorized to adopt rules relating to the time, place, and manner in which a
14 ((nonprofit organization)) person may vend merchandise in which the ((organization's)) person's
15 political, religious, sociological, or ideological message is inextricably intertwined if the sale
16 exercises the permittee's rights guaranteed by the United States or ((the)) Washington
17 Constitution. These rules may address the issuance and duration of permits, the size and
18 placement of tables and other equipment used, their siting and location on the public place or
19 public property, the type of merchandise offered for sale, advertising and posting of prices, the
20 display of licenses, the exclusion of ineligible merchandise, the documentation to accompany
21 applications for registration, and the prohibitions against discrimination, among other subjects.

1 An authorizing official may authorize vending in a public place as part of a street fair,
2 carnival, athletic activity, or other public event authorized by and in accordance with a permit
3 issued by the Special Events Committee under Chapter 15.52.

4 Section 20. Section 15.32.200 of the Seattle Municipal Code, enacted by Ordinance
5 124598, is amended as follows:

6 **15.32.200 At-grade communication cabinets**

7 * * *

8 F. The applicant for a new at-grade communication cabinet proposal that is more than 36
9 inches in height including footings or bases as measured from the grade of the surrounding
10 public place, or has a maximum volume of more than 18 cubic feet, shall: (1) send notice of ((an
11 ~~SDOT~~) a Seattle Department of Transportation application by first-class mail to all business
12 entities, property owners, and residents located within a 100-foot radius from where the
13 communication cabinet is proposed to be located; and (2) post notice of the new application at
14 the proposed site. The notice shall be displayed towards the nearest public place that abuts the
15 site and is viewable by the public((;)) and shall be maintained on the site for the duration of the
16 public notice period.

17 1. If the new at-grade communication cabinet proposal ((;)) is more than 36 inches
18 in height including footings or bases as measured from the grade of the surrounding public place,
19 or has a maximum volume of more than 18 cubic feet, and is abutting a lot zoned RSL, SF 5000,
20 SF 7200, SF 9600, LR1, LR2, or LR3 as these zoning designations are defined under subsection
21 23.30.010.A and the abutting zoning does not have an RC ((~~designation~~)) classification as shown
22 on the Official Land Use Map, Chapter 23.32 (“residentially ((-)) zoned parcels”) ((;)) , the
23 communication cabinet shall be fully screened from the public place and abutting private

1 property. If it is not feasible to install mitigation screening due to physical site constraints, the
2 applicant shall provide an alternative mitigation proposal within 200 feet of the project. If the
3 alternative mitigation cannot be located within 200 feet of the project, the applicant shall propose
4 an alternative location that the Director shall review and may approve. All mitigation screening
5 shall comply with setback standards in Section ~~((15.32.225))~~ 15.32.250((;)) and remain the
6 permittee's sole responsibility to maintain so long as the communication cabinet or accessory
7 equipment ~~((occupy))~~ occupies the public place. As determined by the Director, mitigation
8 screening may include landscaping, fencing, or visual treatment to the cabinet surface. Visual
9 treatment to the cabinet may include paint, decals, vinyl wraps, photos, or other surface
10 treatments. A cabinet shall be considered fully screened for visual treatment purposes when the
11 treatment is applied to all communication cabinet vertical surfaces.

12 2. The applicant shall send and post all required notices at least three ~~((-))~~
13 calendar days before the start of the public notice period. The mailing and on-site notice shall be
14 on a form provided by the Department of Transportation and shall include: a description of the
15 proposed location and installations, comment period dates, information on how the public can
16 submit comments to ~~((SDOT))~~ the Seattle Department of Transportation, and how to request a
17 reconsideration of a Street Use permit decision. If the proposal is abutting a residentially ~~((-))~~
18 zoned parcel, the mailing and on-site notice shall include a visual and narrative description of the
19 proposed mitigation screening required in subsection 15.32.200.F.1.

20 3. Written comments concerning the application shall be postmarked or emailed
21 to the Director of Transportation within ~~((40))~~ ten business days after the first day of the public
22 notice period.

1 where the communication cabinet is located as defined by the Right-of-Way Improvements
2 Manual or successor rule; and

3 3. An unobstructed 3-foot-wide pedestrian straight path as defined in Section
4 15.02.046 within the designated pedestrian clear zone that extends along the permitted area and
5 for 25 feet on either end of the permitted area's boundaries along the block face.

6 F. ((In addition to any other required setbacks, the at-grade communication cabinet and
7 accessory equipment shall be located at least:

8 1. 3 feet from the curb face; and

9 2. 5 feet from alleys, driveways, bus zone areas, disabled person parking zones,
10 commercial loading zones, and fire hydrants; and

11 3. 5 feet from curb ramps, parking meters or pay stations, traffic signs, utility
12 poles, bike racks, and other street fixtures; and

13 4. 10 feet along the curb line from the point where the radius of corner curb area
14 intersects the curb line; and

15 5. 15 feet from any business entrance or exit; and

16 6. 1 foot from edge of sidewalk.

17 7. A smaller setback than that required by subsections 15.32.250.F.3,
18 15.32.250.F.4, 15.32.250.F.5, or 15.32.250.F.6 may be allowed by the Director of
19 Transportation, provided the Director determines the cabinet can be installed with a reduced
20 setback without impairing public safety or access, and will not conflict with other setback
21 requirements established by code or rule.)) The communication cabinet shall comply with
22 clearances required in the Right-of-Way Improvements Manual or successor rule. In addition to
23 any other required setbacks, the communication cabinet:

1 1. Shall not be sited in a manner that adversely affects pedestrian mobility directly
2 beyond the permitted footprint area or inhibits the operation, maintenance, or functionality of
3 any utilities or street fixtures;

4 2. Shall not be located in the furniture zone when the curb space is designated as a
5 bus zone area, disabled person parking zone, food-vehicle zone, or commercial loading zone;

6 3. Shall be located:

7 a. At least 15 feet from any business entrance or exit;

8 b. At least 10 feet from the corner clearance zone when located in the
9 furniture zone; and

10 c. At least 5 feet from curb ramps, curb ramp landings, alleys, driveways;

11 G. The Traffic Engineer or Director of Transportation has authority to require dimensions
12 greater than the minimum standards included in subsections 15.32.250.E and 15.32.250.F to
13 provide for pedestrian passage, traffic management, or any other public-use purpose.

14 ~~((G))~~ H. The communication cabinet and accessory equipment shall not be located in a
15 manner that violates the Americans with Disabilities Act.

16 ~~((H))~~ I. The permittee shall maintain the exterior of all communication cabinets and any
17 applicable mitigation screening, ~~((and))~~ remove graffiti, and repair any exterior damage to the
18 cabinet or mitigation screening within ~~((10))~~ ten calendar days from the date the permittee
19 becomes aware of the graffiti or damage by any means.

20 ~~((I))~~ J. All permittees shall submit to the Seattle Department of Transportation a quarterly
21 report with the first report due at the end of the third month of each year that describes each
22 complaint received in the prior quarter, how the complaint was resolved, and how long it took to
23 resolve the complaint.

1 Section 22. The provisions of this ordinance are declared to be separate and severable.
2 The invalidity of any clause, sentence, paragraph, subdivision, section, or portion of this
3 ordinance, or the invalidity of its application to any person or circumstance, does not affect the
4 validity of the remainder of this ordinance or the validity of its application to other persons or
5 circumstances.

1 Section 23. This ordinance shall take effect and be in force 30 days after its approval by
2 the Mayor, but if not approved and returned by the Mayor within ten days after presentation, it
3 shall take effect as provided by Seattle Municipal Code Section 1.04.020.

4 Passed by the City Council the 23rd day of September, 2019,
5 and signed by me in open session in authentication of its passage this 23rd day of
6 September, 2019.

7 

8 President _____ of the City Council

9 Approved by me this 4th day of October, 2019.

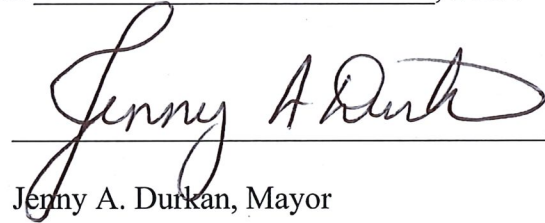
10 
11 Jenny A. Durkan, Mayor

12 Filed by me this 4th day of OCTOBER, 2019.

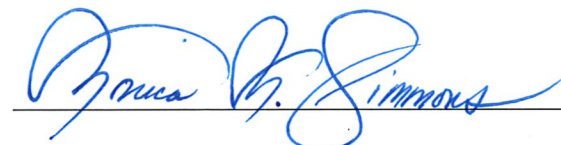
13 
14 Monica Martinez Simmons, City Clerk

15 (Seal)