



SEATTLE CITY COUNCIL

Legislative Summary

CB 118781

Record No.: CB 118781

Type: Ordinance (Ord)

Status: Passed

Version: 1

Ord. no: Ord 125161

In Control: City Clerk

File Created: 07/29/2016

Final Action: 10/07/2016

Title: AN ORDINANCE relating to the Seattle Building Code; amending Section 22.100.010 of the Seattle Municipal Code; adopting by reference Chapters 2 through 29, Chapters 31 through 33, and Chapter 35 of the 2015 International Building Code, and amending certain of those chapters; adopting a new Chapter 1 related to administration, permitting, and enforcement; adopting a new Chapter 30 related to elevators and conveying systems; and repealing Sections 2 through 27 of Ordinance 124273.

Date

Notes:

Filed with City Clerk:

Mayor's Signature:

Sponsors: Johnson

Vetoed by Mayor:

Veto Overridden:

Veto Sustained:

Attachments: Full Text: CB 118781

Drafter: Jenifer.Gilliland@seattle.gov

Filing Requirements/Dept Action:

History of Legislative File

Legal Notice Published:

Yes

No

| Ver- sion: | Acting Body: | Date: | Action: | Sent To: | Due Date: | Return Date: | Result: |
|---------------|---|------------|------------------------------------|--|-----------|-----------------|---------|
| 1 | Mayor | 08/23/2016 | Mayor's leg transmitted to Council | City Clerk | | | |
| 1 | City Clerk | 08/23/2016 | sent for review | Council President's Office | | | |
| | Action Text: The Council Bill (CB) was sent for review. to the Council President's Office | | | | | | |
| | Notes: | | | | | | |
| 1 | Council President's Office | 09/01/2016 | sent for review | Planning, Land Use, and Zoning Committee | | | |
| | Action Text: The Council Bill (CB) was sent for review. to the Planning, Land Use, and Zoning Committee | | | | | | |
| | Notes: | | | | | | |

- 1 Full Council 09/06/2016 referred Planning, Land Use, and Zoning Committee
- 1 Planning, Land Use, and Zoning Committee 09/15/2016 pass Pass
Action Text: The Committee recommends that Full Council pass the Council Bill (CB).
Notes:
In Favor: 2 Chair Johnson, Vice Chair O'Brien
Opposed: 0
Absent(NV): 1 Member Herbold
- 1 Full Council 10/03/2016 passed Pass
Action Text: The Council Bill (CB) was passed by the following vote, and the President signed the Bill:
Notes:
In Favor: 7 Councilmember Bagshaw, Councilmember Burgess, Councilmember González , Council President Harrell, Councilmember Johnson, Councilmember Juarez, Councilmember O'Brien
Opposed: 0
- 1 City Clerk 10/05/2016 submitted for Mayor's signature Mayor
- 1 Mayor 10/07/2016 Signed
- 1 Mayor 10/07/2016 returned City Clerk
- 1 City Clerk 10/07/2016 attested by City Clerk
Action Text: The Ordinance (Ord) was attested by City Clerk.
Notes:
-

CITY OF SEATTLE

ORDINANCE 125161

COUNCIL BILL 118781

AN ORDINANCE relating to the Seattle Building Code; amending Section 22.100.010 of the Seattle Municipal Code; adopting by reference Chapters 2 through 29, Chapters 31 through 33, and Chapter 35 of the 2015 International Building Code, and amending certain of those chapters; adopting a new Chapter 1 related to administration, permitting, and enforcement; adopting a new Chapter 30 related to elevators and conveying systems; and repealing Sections 2 through 27 of Ordinance 124273.

BE IT ORDAINED BY THE CITY OF SEATTLE AS FOLLOWS:

Section 1. Section 22.100.010 of the Seattle Municipal Code, last amended by Ordinance 124273, is amended as follows:

22.100.010 Adoption of the ((International)) Seattle Building Code

The Seattle Building Code is adopted and consists of: 1) ~~((the following portions of the 2012 edition of the International Building Code published by the International Code Council:))~~ Chapters 2 through 29, Chapters 31 through 33, and Chapter 35 of the 2015 edition of the International Building Code as amended by the ordinance introduced as Council Bill 118781; and ~~((2) the amendments and additions to the 2012 International Building Code adopted by City Council by ordinance; and 3))~~ 2) Chapters 1 and 30 as adopted by ((City Council by)) the ordinance introduced as Council Bill 118781. One copy of the ~~((2012))~~ 2015 International Building Code is filed with the City Clerk in C.F. ~~((313183))~~ 319954.

1 Section 2. Chapter 1 of the Seattle Building Code is adopted to read as follows:

2 **CHAPTER 1**

3 **ADMINISTRATION**

4 **SECTION 101**

5 **TITLE, PURPOSE AND SCOPE**

6 **101.1 Title.** This subtitle shall be known as the “Seattle Building Code,” may be so cited, and is
7 referred to herein as “this code.”

8 **101.2 Scope.** This code applies to the construction and occupancy of any building or structure
9 within the City. Repair, alteration, change of occupancy, addition to, relocation and maintenance
10 of buildings and structures shall comply with this code as required by the International Existing
11 Building Code. This code applies to unsafe buildings, structures, equipment and premises. See
12 Chapter 32 for regulation of structures located on, over or under public property or a public right
13 of way.

14 **Exceptions:**

- 15 1. Detached one- and two-family dwellings and multiple single-family dwellings
16 (townhouses) not more than three stories above grade plane in height with a separate
17 means of egress, and their accessory structures not more than three stories above grade
18 plane in height, shall comply with the *International Residential Code*.
- 19 2. This code does not apply to public utility towers and poles, mechanical equipment not
20 specifically regulated in this code, construction equipment and structural components
21 thereof, and hydraulic flood control structures.

1 **101.2.1 Existing buildings.** The International Existing Building Code applies to the repair,
2 alteration, change of occupancy, addition to, relocation and maintenance of existing
3 buildings.

4 **101.3 Applicability of city laws.** A building permit application shall be considered under
5 applicable city law in effect on the date a valid and fully complete building permit application is
6 submitted or on a date as otherwise required by law.

7 **Exception:** For any project for which an associated, unexpired master use permit has been
8 issued, a building permit application shall be considered under the versions of Seattle
9 Municipal Code Title 23, Seattle Land Use Code; Seattle Municipal Code Chapter 25.09,
10 Environmentally Critical Areas regulations; and Seattle Municipal Code Chapter 25.09, Tree
11 Protection regulations in effect on the date established by Seattle Municipal Code Section
12 23.76.026 or 23.76.032.C.1 for consideration of the master use permit, unless that date is
13 later than the date of the complete building permit application. This exception does not apply
14 to a subdivision or short subdivision component of a master use permit.

15 **Note:** Applicable city law includes but is not limited to the Seattle Municipal Code Title 23,
16 Seattle Land Use Code; Seattle Municipal Code Chapter 25.09, Environmentally Critical
17 Areas regulations; Seattle Municipal Code Chapter 25.09, Tree Protection regulations; and
18 the Seattle Building, Mechanical, Fuel Gas, Energy, Stormwater, Grading and Side Sewer
19 codes.

20 **101.3.1 Complete building permit applications.** A building permit application is complete
21 if the building official determines it meets the requirements of Sections 106.5.1 through
22 106.5.7, and the application includes, without limitation, the construction documents for the
23 architectural and structural components of the building.

1 **Exception:** If the building official allows a building permit application to be submitted in
2 phases for portions of a building, each phased portion submittal shall meet the
3 requirements of Sections 106.5.1 through 106.5.7 applicable to the scope of the allowed
4 phased portion, and the building permit application shall be considered complete for the
5 purposes of Section 101.3 on the date the phased portion submittal that includes the
6 structural frame for the entire building is submitted.

7 **101.3.2 Initial tenant improvements.** Complete permit applications for the initial tenant
8 alterations submitted no later than 18 months after the date of the approved final inspection
9 for the building shall be considered under the codes applicable to the permit application for
10 the building in accordance with Section 101.3.

11 Complete permit applications for initial tenant alterations submitted more than 18 months
12 after the date of the approved final inspection for the building shall comply with the codes in
13 effect at the time of application.

14 **101.5 Purpose.** The purpose of this code is to provide minimum standards to safeguard life or
15 limb, health, property and public welfare by regulating and controlling the design, construction,
16 quality of materials, occupancy, location and maintenance of buildings and structures within the
17 City and certain equipment specifically regulated herein. The purpose of this code is to provide
18 for and promote the health, safety and welfare of the general public, and not to create or
19 otherwise establish or designate any particular class or group of persons who will or should be
20 especially protected or benefited by the terms of this code.

21 **101.6 Internal consistency.** Where in any specific case, different sections of this code specify
22 different materials, methods of construction or other requirements, the most restrictive governs.

1 Where there is a conflict between a general requirement and a specific requirement, the specific
2 requirement governs.

3 **101.7 Referenced codes and standards.** The codes and standards referenced in this code are
4 considered part of this code to the extent prescribed by each such reference. If differences occur
5 between provisions of this code and referenced codes and standards, the provisions of this code
6 apply, except that nothing in this code limits the effect of any provision of the Grading Code,
7 Stormwater Code, or Regulations for Environmentally Critical Areas.

8 **101.8 Appendices.** Provisions in the appendices of the *International Building Code* do not
9 apply unless specifically adopted.

10 **101.9 Metric units.** Wherever in this code there is a conflict between metric units of
11 measurement and U.S. customary units, the U.S. customary units govern.

12 SECTION 102

13 UNSAFE BUILDINGS, STRUCTURES OR PREMISES

14 **102.1 Emergency order.** Whenever the building official finds that any building or structure or
15 premises, or portion thereof is in such a dangerous and unsafe condition as to constitute an
16 imminent hazard to life or limb, the building official may issue an emergency order. The
17 emergency order may (1) direct that the building, structure or premises, or portion thereof be
18 restored to a safe condition by a date certain; (2) require that the building, structure or premises,
19 or portion thereof, be vacated within a reasonable time to be specified in the order, or in the case
20 of extreme danger, may specify immediate vacation of the building, structure or premises, or
21 portion thereof; or (3) authorize immediate disconnection of the utilities or energy source.

1 **102.1.1 Service of emergency order.** The order shall be posted on the premises or
2 personally served on the owner of the building or premises or any person responsible for the
3 condition. The order shall specify the time for compliance.

4 **102.1.2 Effect of emergency order.** No person may occupy a building, structure or
5 premises, or portion thereof, after the date on which the building is required to be vacated
6 until the building, structure or premises, or portion thereof, is restored to a safe condition as
7 required by the order and this code. It is a violation for any person to fail to comply with an
8 emergency order issued by the building official.

9 **102.2 Hazard correction order.** Whenever the building official finds that an unsafe building,
10 structure or premises exists, the building official may issue a hazard correction order specifying
11 the conditions causing the building, structure or premises to be unsafe and directing the owner or
12 other person responsible for the unsafe building, structure or premises to correct the condition by
13 a date certain. In lieu of correction, the owner may submit a report or analysis to the building
14 official analyzing said conditions and establishing that the building, structure or premises is, in
15 fact, safe. The building official may require that the report or analysis be prepared by a licensed
16 engineer and may require compliance with the International Existing Building Code.

17 **102.2.1 Service of hazard correction order.** The order shall be served upon the owner,
18 agent or other responsible person by personal service or regular first class mail addressed to
19 the last known address of such person or if no address is available after reasonable inquiry,
20 the order may be posted in a conspicuous place on the premises. The order may also be
21 posted if served by personal service or first class mail.

22 **102.2.2 Effect of hazard correction order.** It is a violation for any person to fail to comply
23 with a hazard correction order as specified in this subsection.

SECTION 103

ENFORCEMENT, VIOLATIONS AND PENALTIES

103.1 Violations. It is a violation of this code for any person to:

1. Erect, construct, enlarge, repair, move, improve, remove, convert, demolish, equip, occupy, inspect or maintain any building or structure, or cause or permit the same to be done, in the City, contrary to or in violation of any of the provisions of this code;
2. Knowingly aid, abet, counsel, encourage, hire, induce or otherwise procure another to violate or fail to comply with this code;
3. Use any material or to install any device, appliance or equipment that does not comply with applicable standards of this code or that has not been approved by the building official;
4. Violate or fail to comply with any order issued by the building official pursuant to the provisions of this code or with any requirements of this code;
5. Remove, mutilate, destroy or conceal any notice or order issued or posted by the building official pursuant to the provisions of this code, or any notice or order issued or posted by the building official in response to a natural disaster or other emergency;
6. Conduct work under a permit without requesting an inspection as required by Section 108.

103.2 Notice of violation. If, after investigation, the building official determines that standards or requirements of this code have been violated or that orders or requirements have not been complied with, the building official may issue a notice of violation upon the owner, agent, or other person responsible for the action or condition. The notice of violation shall state the standards or requirements violated, shall state what corrective action, if any, is necessary to comply with the standards or requirements, and shall set a reasonable time for compliance.

1 **103.2.1 Service of notice of violation.** The notice shall be served upon the owner, agent or
2 other responsible person by personal service or regular first class mail addressed to the last
3 known address of such person or if no address is available after reasonable inquiry, the
4 notice may be posted in a conspicuous place on the premises. The notice may also be posted
5 if served by personal service or first class mail. Nothing in this section limits or precludes
6 any action or proceeding to enforce this code, and nothing obligates or requires the building
7 official to issue a notice of violation prior to the imposition of civil or criminal penalties.

8 **103.2.2 Review of notice of violation by the building official.** Any person affected by a
9 notice of violation issued pursuant to Section 103.2 may obtain a review of the notice by
10 making a request in writing to the building official within ten days after service of the notice.
11 When the last day of the period computed is a Saturday, Sunday, or city holiday, the period
12 runs until 5 p.m. of the next business day.

13 **103.2.2.1 Review procedure.** The review shall occur not less than ten nor more than 20
14 days after the request is received by the building official unless otherwise agreed to by
15 the person requesting the review. Any person affected by the notice of violation may
16 submit additional information to the building official. The review shall be made by a
17 representative of the building official who will review any additional information that is
18 submitted and the basis for issuance of the notice of violation. The reviewer may request
19 clarification of the information received and a site visit.

20 **103.2.2.2 Decision.** After the review, the building official shall:

- 21 1. Sustain the notice;
- 22 2. Withdraw the notice;
- 23 3. Amend the notice; or

1 4. Continue the review to a date certain.

2 **103.2.2.3 Order.** The building official shall issue an order containing the decision
3 within 15 days of the date that the review is completed and shall cause the order to be
4 mailed by regular first class mail to the persons requesting the review and the persons
5 named on the notice of violation, addressed to their last known addresses.

6 **103.3 Stop work orders.** The building official may issue a stop work order whenever any work
7 is being done contrary to the provisions of this code or contrary to a permit issued by the
8 building official, or in the event of dangerous or unsafe conditions related to construction or
9 demolition. The stop work order shall identify the violation and may prohibit work or other
10 activity on the site.

11 **103.3.1 Service of stop work order.** The building official shall serve the stop work order by
12 posting it in a conspicuous place at the site. If posting is not physically possible, the stop
13 work order may be served by personal service or by regular first class mail to the last known
14 address of: the property owner, the person doing or causing the work to be done, or the
15 holder of a permit if work is being stopped on a permit. For purposes of this section, service
16 is complete at the time of posting or of personal service, or if mailed, three days after the date
17 of mailing. When the last day of the period so computed is a Saturday, Sunday or city
18 holiday, the period runs until 5 p.m. on the next business day.

19 **103.3.2 Effective date of stop work order.** Stop work orders are effective when posted, or
20 if posting is not physically possible, when one of the persons identified in Section 103.3.1 is
21 served.

1 **103.3.3 Review of stop work orders by the building official.** Any person aggrieved by a
2 stop work order may obtain a review of the order by delivering to the building official a
3 request in writing within two business days of the date of service of the stop work order.

4 **103.3.3.1 Review procedure.** The review shall occur within two business days after
5 receipt by the building official of the request for review unless otherwise agreed by the
6 person making the request. Any person affected by the stop work order may submit
7 additional information to the building official for consideration as part of the review at
8 any time prior to the review. The review will be made by a representative of the building
9 official who will review all additional information received and may also request a site
10 visit.

11 **103.3.3.2 Decision.** After the review, the building official may:

- 12 1. Sustain the stop work order;
- 13 2. Withdraw the stop work order;
- 14 3. Modify the stop work order; or
- 15 4. Continue the review to a date certain.

16 **103.3.3.3 Order.** The building official shall issue an order containing the decision
17 within two business days after the review is completed and shall cause the order to be
18 sent by regular first class mail to the person or persons requesting the review, any person
19 on whom the stop work order was served, and any other person who requested a copy
20 before issuance of the order, addressed to their last known address.

21 **103.4 Occupancy violations.** Whenever any building or structure is being occupied contrary to
22 the provisions of this code, the building official may order such occupancy discontinued and the
23 building or structure, or portion thereof, vacated by notice.

1 **103.4.1 Service of notice of occupancy violation.** The notice of occupancy violation shall
2 be served upon the owner, agent or other responsible person by personal service or regular
3 first class mail addressed to the last known address of such person or if no address is
4 available after reasonable inquiry, the notice may be posted in a conspicuous place on the
5 premises. The notice may also be posted if served by personal service or first class mail.

6 **103.4.2 Compliance with notice of occupancy violation.** Any person occupying the
7 building or structure shall discontinue the occupancy by the date specified in the notice of the
8 building official, or shall make the building or structure, or portion thereof, comply with the
9 requirements of this code; provided, however, that in the event of an unsafe building, Section
10 102 may apply.

11 **103.5 Civil penalties.** Any person violating or failing to comply with the provisions of this
12 code shall be subject to a cumulative civil penalty in an amount not to exceed \$500 per day for
13 each violation from the date the violation occurs or begins until compliance is achieved, except
14 that the penalty for violations of Section 3107.4.1 shall be \$1500 per day. In cases where the
15 building official has issued a notice of violation, the violation will be deemed to begin, for
16 purposes of determining the number of days of violation, on the date compliance is required by
17 the notice of violation.

18 **103.6 Enforcement in Municipal Court.** Civil actions to enforce Title 22 of the Seattle
19 Municipal Code (SMC) shall be brought exclusively in Seattle Municipal Court, except as
20 otherwise required by law or court rule. In any civil action for a penalty, the City has the burden
21 of proving by a preponderance of the evidence that a violation exists or existed; the issuance of a
22 notice of violation or of an order following a review by the building official is not itself evidence
23 that a violation exists.

1 **103.7 Judicial review.** Because civil actions to enforce Title 22 SMC must be brought
2 exclusively in Seattle Municipal Court pursuant to Section 103.6, orders of the building official
3 including Notices of Violation issued under this chapter are not subject to judicial review
4 pursuant to Chapter 36.70C RCW.

5 **103.8 Alternative criminal penalty.** Anyone who violates or fails to comply with any notice of
6 violation or order issued by the building official pursuant to this code or who removes, mutilates,
7 destroys or conceals a notice issued or posted by the building official shall, upon conviction
8 thereof, be punished by a fine of not more than \$5000 or by imprisonment for not more than 365
9 days, or by both such fine and imprisonment for each separate violation. Each day's violation
10 shall constitute a separate offense.

11 **103.9 Additional relief.** The building official may seek legal or equitable relief to enjoin any
12 acts or practices and abate any condition when necessary to achieve compliance.

13 **103.10 Administrative review by the building official.** Prior to issuance of the building
14 permit, applicants may request administrative review by the building official of decisions or
15 actions pertaining to the administration and enforcement of this code. Requests shall be
16 addressed to the building official.

17 **103.11 Administrative review by the Construction Codes Advisory Board.** After
18 administrative review by the building official, and prior to issuance of the building permit,
19 applicants may request review of decisions or actions pertaining to the application and
20 interpretation of this code by the Construction Codes Advisory Board, except for stop work
21 orders, notices of violations, revocations of permits, and enforcement of Section 3107. The
22 review will be performed by three or more members of the Construction Codes Advisory Board,
23 chosen by the Board Chair. The Chair shall consider the subject of the review and members'

1 expertise when selecting members to conduct a review. The decision of the review panel is
2 advisory only; the final decision is made by the building official.

3 **103.12 Recording of notices.** The building official may record a copy of any order or notice
4 with the Department of Records and Elections of King County.

5 **103.13 Appeal to Superior Court.** Final decisions of the Seattle Municipal Court on
6 enforcement actions authorized by Title 22 and this code may be appealed pursuant to the Rules
7 for Appeal of Decisions of Courts of Limited Jurisdiction.

8 SECTION 104

9 ORGANIZATION AND DUTIES

10 **104.1 Jurisdiction of Department of Construction and Inspections.** The Department of
11 Construction and Inspections is authorized to administer and enforce this code. The Department
12 of Construction and Inspections is under the administrative and operational control of the
13 Director, who is the building official.

14 **104.2 Designees.** The building official may appoint such officers, inspectors, assistants and
15 employees as are authorized from time to time. The building official may authorize such
16 employees and other agents as may be necessary to carry out the functions of the building
17 official.

18 **104.3 Right of entry.** With the consent of the owner or occupier of a building or premises, or
19 pursuant to a lawfully issued warrant, the building official may enter a building or premises at
20 any reasonable time to perform the duties imposed by this code.

21 **104.4 Modifications.** The building official may modify the requirements of this code for
22 individual cases provided the building official finds: (1) there are practical difficulties involved
23 in carrying out the provisions of this code; (2) the modification is in conformity with the intent

1 and purpose of this code; and (3) the modification will provide a reasonable level of strength,
2 effectiveness, fire resistance, durability, safety and sanitation when considered together with
3 other safety features of the building or other relevant circumstances. The building official may,
4 but is not required to, record the approval of modifications and any relevant information in the
5 files of the building official or on the approved construction documents.

6 **104.5 Alternate materials, methods of construction and design.** This code does not prevent
7 the use of any material, design or method of construction not specifically allowed or prohibited
8 by this code, provided the alternate has been approved and its use authorized by the building
9 official. The building official may approve an alternate, provided the building official finds that
10 the proposed alternate complies with the provisions of this code and that the alternate, when
11 considered together with other safety features of the building or other relevant circumstances,
12 will provide at least an equivalent level of strength, effectiveness, fire resistance, durability,
13 safety and sanitation. Certain code alternates have been pre-approved by the building official
14 and are identified in this code as numbered code alternates. The building official may require
15 that sufficient evidence or proof be submitted to reasonably substantiate any claims regarding the
16 use or suitability of the alternate. The building official may, but is not required to, record the
17 approval of code alternates and any relevant information in the files of the building official or on
18 the approved construction documents.

19 **104.6.1 Flood hazard areas.** The building official shall not grant modifications to any provision
20 required in flood hazard areas as established by Section 1612.3 unless a determination has been
21 made that:

- 1 1. A showing of good and sufficient cause that the unique characteristics of the size,
2 configuration or topography of the site render the elevation standards of Section 1612
3 inappropriate.
- 4 2. A determination that failure to grant the variance would result in exceptional hardship by
5 rendering the lot undevelopable.
- 6 3. A determination that the granting of a variance will not result in increased flood heights,
7 additional threats to public safety, extraordinary public expense, cause fraud on or
8 victimization of the public, or conflict with existing laws or ordinances.
- 9 4. A determination that the variance is the minimum necessary to afford relief, considering
10 the flood hazard.
- 11 5. Submission to the applicant of written notice specifying the difference between the
12 design flood elevation and the elevation to which the building is to be built, stating that
13 the cost of flood insurance will be commensurate with the increased risk resulting from
14 the reduced floor elevation, and stating that construction below the design flood
15 elevation increases risks to life and property.

16 **104.7 Tests.** Whenever there is insufficient evidence of compliance with any of the provisions of
17 this code or evidence that any material or construction does not conform to the requirements of
18 this code, the building official may require tests as proof of compliance to be made at no expense
19 to the City. Test methods shall be specified by this code or by other recognized test standards. If
20 there are no recognized and accepted test methods for the proposed alternate, the building official
21 shall determine the test procedures. All tests shall be made by an approved agency. Reports of
22 such tests shall be retained by the building official for the period required for retention of public
23 records.

1 **104.8 Rules of the building official.** The building official has authority to issue interpretations
2 of this code and to adopt and enforce rules and regulations supplemental to this code as may be
3 deemed necessary in order to clarify the application of the provisions of this code. Such
4 interpretations, rules and regulations shall be in conformity with the intent and purpose of this
5 code.

6 **104.8.1 Procedure.** The building official shall promulgate, adopt and issue rules according
7 to the procedures specified in the Administrative Code, Chapter 3.02 of the Seattle Municipal
8 Code.

9 **104.9 Liability.** Nothing in this code is intended to be nor shall be construed to create or form
10 the basis for any liability on the part of the City, or its officers, employees or agents, for any
11 injury or damage resulting from the failure of a building to conform to the provisions of this
12 code, or by reason or as a consequence of any inspection, notice, order, certificate, permission or
13 approval authorized or issued or done in connection with the implementation or enforcement of
14 this code, or by reason of any action or inaction on the part of the City related in any manner to
15 the enforcement of this code by its officers, employees or agents.

16 This code shall not be construed to relieve or lessen the responsibility of any person
17 owning, operating or controlling any building or structure for any damages to persons or
18 property caused by defects, nor shall the Department of Construction and Inspections or the City
19 of Seattle be held to have assumed any such liability by reason of the inspections authorized by
20 this code or any permits or certificates issued under this code.

21 **104.10 Responsibilities of parties.**

22 **104.10.1 Responsibility for compliance.** Compliance with the requirements of this code is
23 the obligation of the owner of the building, structure, or premises, the duly authorized agent

1 of the owner, and other persons responsible for the condition or work, and not of the City or
2 any of its officers, employees or agents.

3 **104.10.2 Responsibilities of registered design professional in responsible charge.** It is the
4 responsibility of the *registered design professional in responsible charge* to ensure that the
5 information in the construction documents is complete, accurate, and, to the best of the
6 design professional's knowledge, conforms to the requirements of this code.

7 **104.10.3 Responsibilities of structural engineer in responsible charge.** It is the
8 responsibility of the *structural engineer in responsible charge* to:

- 9 1. Design the primary structure;

10 **Exception:** A licensed engineer other than the structural engineer in responsible
11 charge may design the primary structure of single-story metal buildings.

- 12 2. Specify design loads, configurations, controlling dimensions, deflection limits and/or
13 other criteria necessary for the design of secondary structural components and sub-
14 systems and the selection of structurally qualified products;
- 15 3. Determine the adequacy and conformance of the application of the structurally qualified
16 products with the design intent of the City-approved construction documents;
- 17 4. Review for compatibility with the City-approved construction documents previously
18 approved by the building official, the deferred submittals for the primary structural frame
19 and the design and deferred submittals for secondary members for the following
20 structural elements:

Wood trusses

Glu-lam beams

Steel joists

Structural steel

Steel decking

Prefabricated stair systems

| | |
|------------------------|--------------------------------------|
| Precast concrete piles | Post-tensioned floor systems |
| Curtain wall systems | Precast prestressed planks |
| Major skylight frames | Precast concrete/masonry wall panels |

1 The building official may approve additions to, or deletions from this list for specific
2 projects. If there is no structural engineer in responsible charge on the project, the architect in
3 responsible charge shall assume these responsibilities.

4 Note: "Primary structural frame" and "secondary member" are defined in Chapter 2.

5 **104.10.4 Responsibilities of contractor.** It is the responsibility of the contractor to perform
6 all the work in conformance with the City-approved construction documents.

7 **104.10.5 Responsibilities of plans examiner.** It is the responsibility of the plans examiner
8 to verify that the description of the work in the construction documents is substantially
9 complete, and to require corrections where, to the best of the plans examiner's knowledge,
10 the construction documents do not conform to this code or other pertinent laws and
11 ordinances.

12 **104.10.6 Responsibilities of field inspector.** It is the responsibility of the field inspector to
13 conduct inspections to verify that the work in progress conforms with the approved
14 construction documents and to require corrections where, to the best of the field inspector's
15 knowledge, the work either does not conform to the construction documents or where the
16 work is in violation of this code or other pertinent laws and ordinances.

17 SECTION 105

18 CONSTRUCTION CODES ADVISORY BOARD

19 **105.1 Establishment.** There is a "Construction Codes Advisory Board" ("Board") consisting of
20 13 voting members, appointed by the Mayor and subject to confirmation by the City Council.

1 The Board membership consists of one representative of each of the following professions or
2 organizations. The representative of a profession need not be a member of the profession but
3 may be a representative of an organization of such professionals.

4 1 architect;

5 1 structural engineer;

6 1 electrical engineer;

7 1 heating, refrigeration and air-conditioning engineer;

8 1 general contractor;

9 1 electrical contractor;

10 1 commercial building owner or operator;

11 1 apartment building owner or operator;

12 1 developer and/or contractor of residential projects;

13 1 member of organized labor; and

14 3 members of the general public.

15 A representative of each of the following departments shall be ex officio, non-voting
16 members of the Board:

17 Seattle Fire Department;

18 Seattle City Light; and

19 Seattle-King County Department of Public Health.

20 **105.2 Duties of Board.** The Board shall act in an advisory capacity for all of its duties. The
21 Board shall meet on call either by the building official or the Board Chair, subject to timely
22 notice.

1 **105.2.1 Code adoption and amendment.** The Board may examine proposed new editions
2 and amendments to the following codes and regulations listed in this section. The Board may
3 make recommendations to the building official and to the City Council for adoption and
4 amendment of these codes.

5 Seattle Building Code - Chapter 22.100 SMC*

6 Seattle Residential Code – Chapter 22.150 SMC

7 Seattle Mechanical Code - Chapter 22.400 SMC

8 Seattle Fuel Gas Code - Chapter 22.420 SMC

9 Seattle Boiler Code - Chapter 22.450 SMC

10 Seattle Energy Code- Chapter 22.700 SMC

11 Seattle Electrical Code - Chapter 22.300 SMC

12 Seattle Plumbing Code – SMC Title 22 Subtitle V

13 * SMC is the Seattle Municipal Code.

14 **105.2.2 Review of director's rules.** The Board may examine proposed administrative rules
15 relating to the codes and regulations listed above and make recommendations to the building
16 official.

17 **105.3 Organization.** The Board shall organize, and elect a chair and any other officers as may
18 be established by the Board. The Board may adopt rules of procedure. There shall be a
19 committee of the Board for each code assigned to its review. Committees shall consist of Board
20 members and may include additional members such as other representatives of the general public
21 and professions not specifically represented on the Board. Any non-Board members of
22 committees shall be appointed by the Chair. The Chair may, from time to time, appoint special
23 topic subcommittees.

1 **105.4 Terms of service.** Terms of Board members are three years, dating from the day of
2 expiration of the preceding term; provided, a member whose term has expired shall continue to
3 serve until a successor is appointed and confirmed. Terms on the Board shall be staggered so
4 that the terms of not more than five positions expire concurrently. Vacancies shall be filled for
5 any unexpired term in the same manner as the original appointment.

6 **105.5 Removal of Board member.** A member may be removed by the Mayor, subject to a
7 majority vote of members of the City Council.

8 **105.6 Compensation of Board members.** No member shall receive any compensation for
9 service on the Board.

10 SECTION 106

11 BUILDING PERMITS

12 **106.1 Permits required.** Except as otherwise specifically provided in this code, a building
13 permit shall be obtained from the building official for each building or structure prior to erecting,
14 constructing, enlarging, altering, repairing, moving, improving, removing, changing the
15 occupancy of, or demolishing such building or structure, or allowing the same to be done. All
16 work shall comply with this code, even where no permit is required.

17 **106.2 Work exempt from permit.** A building permit is not required for the work listed below.
18 Exemption from the permit requirements of this code does not authorize any work to be done in
19 any manner in violation of this code or any other laws or ordinances of the City.

- 20 1. Minor repairs or alterations if the value of construction, as determined by the building
21 official, is \$6,000 or less in any six month period. Such repairs and alterations shall not
22 include the removal, reduction, alteration, or relocation of any loadbearing support.
23 Egress, light, ventilation, and fire-resistance shall not be reduced without a permit.

- 1 2. Minor work including the following, provided no changes are made to the building
2 envelope: patio and concrete slabs on grade, painting or cleaning a building, repointing a
3 chimney, installing kitchen cabinets, paneling or other surface finishes over existing wall
4 and ceiling systems applied in accordance with Chapter 8, insulating existing buildings,
5 abatement of hazardous materials, demolition of nonstructural interior tenant
6 improvements in retail and office uses, and in-kind or similar replacement of or repair of
7 deteriorated members of a structure.
- 8 3. One-story detached accessory buildings used for greenhouse, tool or storage shed,
9 playhouse, or similar uses, if:
 - 10 3.1 The projected roof area does not exceed 120 square feet; and
 - 11 3.2 The building is not placed on a concrete foundation other than a slab on grade.
- 12 4. Fences not over 8 feet high that do not have masonry or concrete elements above 6 feet.
- 13 5. Arbors and other open-framed landscape structures not exceeding 120 square feet in
14 projected area.
- 15 6. Display cases, cabinets, counters and partitions not over 5 feet 9 inches high.
- 16 7. Retaining walls and rockeries which are not over 4 feet in height measured from the
17 bottom of the footing to the top of the wall, if:
 - 18 7.1 There is no surcharge or impoundment of Class I, II or III-A liquids.
 - 19 7.2 The wall or rockery is not located in an Environmentally Critical Area (ECA) or
20 ECA buffer pursuant to chapter 25.09 of the Seattle Municipal Code;
 - 21 7.3 Construction does not support soils in a steep slope area, potential landslide area or
22 known slide area as identified in the Seattle Environmentally Critical Areas
23 Ordinance Section 25.09.020 of the Seattle Municipal Code.

- 1 7.4 Possible failure would likely cause no damage to adjoining property or structures.
- 2 8. Platforms, walks and driveways not more than 18 inches above grade and not over any
- 3 basement or story below.
- 4 9. Temporary motion picture, television and theater stage sets and scenery.
- 5 10. Window awnings supported by an exterior wall of Group R-3, and Group U occupancies
- 6 when projecting not more than 54 inches.
- 7 11. Prefabricated swimming pools, spas and similar equipment accessory to a Group R-3
- 8 occupancy in which the pool walls are entirely above the adjacent grade and if the
- 9 capacity does not exceed 5,000 gallons.
- 10 12. Replacement of siding. This shall not include structural changes, replacement of
- 11 sheathing or alterations to doors and windows. See Energy Code Sections (~~R101.4.3,~~
- 12 ~~and C101.4.3~~) R503.1.1, Exceptions 2 and 3 and C503.1, Exceptions 3 and 4, for
- 13 requirements for existing buildings.
- 14 13. Roof recover.
- 15 14 Roof replacement under either of the following conditions:
- 16 14.1 In one- and two-family dwellings and townhouses if no changes are made to the
- 17 building envelope other than adding or replacing insulation, and the insulation value
- 18 is equivalent to or better than the existing structure; or
- 19 14.2 Where less than 500 square feet of roof sheathing or insulation is exposed within
- 20 any 6 month period. Permits are required for structural changes and replacement of
- 21 sheathing of any size. See Energy Code Sections (~~R101.4.3 and C101.4.3~~
- 22 R503.1.1, C503.1 and C503.3) for insulation requirements for existing buildings.
- 23 15. School, park or private playground equipment including tree houses.

1 16. Removal and/or replacement of underground storage tanks that are subject to regulation
2 by a state or federal agency.

3 **Note:** A Fire Department permit is required for removal, replacement and
4 decommissioning of underground storage tanks.

5 17. Installation of dish and panel antennas 6.56 feet (2 m) or less in diameter or diagonal
6 measurement.

7 18. Water tanks not located in Environmentally Critical Areas that are supported directly on
8 grade if the capacity is not greater than 5,000 gallons (18 925 L) and the ratio of height to
9 diameter or width is not greater than 2:1.

10 **106.3 Other permits required.** Unless otherwise exempted by this or other pertinent codes,
11 separate master use, plumbing, electrical, mechanical and other permits may be required for the
12 above exempted items.

13 **106.4 Flood hazard areas.** In addition to the permit required by this section, all work to be
14 performed in areas of special flood hazard, as defined in Seattle Municipal Code Chapter 25.06,
15 are subject to additional standards and requirements, including floodplain development approval
16 or a Floodplain Development License, as set forth in Chapter 25.06, the Seattle Floodplain
17 Development Ordinance.

18 **106.4.1 Determination of substantially improved or substantially damaged existing**
19 **buildings and structures in flood hazard areas.** For applications for reconstruction,
20 rehabilitation, *repair, alteration, addition* or other improvement of existing buildings or
21 structures located in *flood hazard areas*, the *building official* shall determine if the proposed
22 work constitutes substantial improvement or *repair of substantial damage*. Where the
23 *building official* determines that the proposed work constitutes *substantial improvement* or

1 *repair of substantial damage*, and where required by this code, the *building official* shall
2 require the building to meet the requirements of Section 1612.

3 **106.5 Application for permit.** To obtain a permit, the applicant shall first file an application a
4 format determined by the building official. Every such application shall:

- 5 1. Identify and describe the work to be covered by the permit for which application is
6 made.
- 7 2. Describe the land on which the proposed work is to be done by legal description,
8 property address or similar description that will readily identify and definitely locate
9 the proposed building or work.
- 10 3. Provide contractor's business name, address, phone number and current contractor
11 registration number (required if contractor has been selected).
- 12 4. Be accompanied by construction documents, including plans and other data as
13 required in Section 106.5.2 through 106.5.7.
- 14 5. State the valuation of any new building or structure or any addition, remodeling or
15 alteration to an existing building including cost breakdown between additions and
16 alterations.
- 17 6. Be signed by the owner of the property or building, or the owner's authorized agent,
18 who may be required to submit evidence to indicate such authority.
- 19 7. Give such other data and information as may be required by the building official,
20 including, but not limited to, master use and shoreline permits and building
21 identification plans.
- 22 8. State the name of the owner and contractor and the name, address and phone number,
23 of a contact person.

1 9. Substantially conform with applicable city law in effect on the date described in
2 Section 101.3, as modified by any exception.

3 10. Applications that include a grading component shall include all information
4 prescribed by the Grading Code and rules adopted thereunder, and all additional
5 information required by the building official pursuant to the Grading Code and rules
6 adopted thereunder.

7 **106.5.1 Construction documents.** Construction documents shall be submitted in two or
8 more sets with each application for a permit, or shall be submitted in electronic format
9 determined by the building official. Computations, stress diagrams, shop and fabrication
10 drawings and other data sufficient to show the adequacy of the plans shall be submitted when
11 required by the building official.

12 **Exception:** The building official may waive the submission of construction
13 documents, if the building official finds that the nature of the work applied for is
14 such that reviewing of construction documents is not necessary to obtain compliance
15 with this code.

16 **106.5.2 Preparation by registered design professionals.** Construction documents for all
17 work shall be prepared and designed by or under the direct supervision of an architect or
18 structural engineer licensed to practice under the laws of the State of Washington. Each sheet
19 of construction documents shall bear the seal and the signature of the registered design
20 professional before the permit is issued.

1 **Exceptions:**

2 1. Construction documents for work not involving structural design are permitted to
3 be prepared by a registered professional engineer or registered architect qualified
4 in the proposed work.

5 2. When authorized by the building official, construction documents for assembly
6 line products or designed specialty structural products may be designed by a
7 registered professional engineer.

8 3. When authorized by the building official, construction documents need not be
9 prepared by an engineer or architect licensed by the State of Washington for the
10 following:

11 3.1. Detached one- and two-family dwellings.

12 3.2 New buildings or structures, and additions, alterations or repairs made to
13 them of conventional light frame construction, if the value of construction,
14 as determined by the building official, is less than \$75,000.

15 3.3. Nonstructural alterations and repairs if the value of construction, as
16 determined by the building official, is less than \$75,000, excluding the value
17 of electrical and mechanical systems, fixtures, equipment, interior finish and
18 millwork.

19 3.4. Other work as specified in rules promulgated by the building official.

20 **106.5.3 Design professional in responsible charge.** The building official is authorized to
21 require the owner to engage and designate on the building permit application a registered
22 design professional who shall act as the registered design professional in responsible charge.

23 If the circumstances require, the owner shall designate a substitute registered design

1 professional in responsible charge who shall perform the duties required of the original
2 registered design professional in responsible charge. The building official shall be notified in
3 writing by the owner if the registered design professional in responsible charge is changed or
4 is unable to continue to perform the duties. The registered design professional in responsible
5 charge is responsible for reviewing and coordinating submittal documents prepared by
6 others, including phased and deferred submittal items, for compatibility with the design of
7 the building.

8 **106.5.4 Information required on construction documents.** Construction documents shall
9 include the following, as applicable:

- 10 1. A plot plan showing the width of streets, alleys, yards and courts.
- 11 2. The location (and/or location within a building), floor area, story, height, type of
12 construction and occupancy classification as defined by the Building Code and
13 use as defined by the Land Use Code of the proposed building and of every
14 existing building on the property.
- 15 3. Where there are more than two buildings located on a property, a building
16 identification plan identifying the location of each building on the property and
17 identifying each building by a numbering system unrelated to address. Such plan
18 is not required where a plan for the site is already on file and no new buildings are
19 being added to the site.
- 20 4. Types of heating and air conditioning systems.
- 21 5. Architectural plans, including floor plans, elevations and door and finish
22 schedules showing location of all doors, windows, mechanical equipment, shafts,
23 pipes, vents and ducts. Fire walls, fire barriers, fire partitions, smoke barriers and

1 smoke partitions or any other wall or horizontal assembly required to have
2 protected openings or penetrations shall be identified on the architectural plans.

3 6. Structural plans, including foundation plan and framing plans.

4 7. Cross-sections and construction details for both architectural and structural plans
5 including wall sections, foundation, floor and roof details, connections of
6 structural members and types of construction material.

7 8. Topographic plans, including original and final contours, location of all buildings
8 and structures on the site and, when required by the building official, adjacent to
9 the site, and cubic yards of cut and fill.

10 9. If the building official has reason to believe that there may be an intrusion into
11 required open areas or over the property line, a survey of the property prepared by
12 a land surveyor licensed by the State of Washington is required for new
13 construction, and for additions or accessory buildings.

14 10. If any building or structure is to be erected or constructed on property abutting an
15 unimproved or partially improved street or alley, the plans shall also include a
16 profile showing the established or proposed grade of the street or alley, based
17 upon information obtained from the Director of Transportation relating to the
18 proposed finished elevations of the property and improvements thereon.

19 11. Where design flood elevations are not specified, they shall be established in
20 accordance with Section 1612.3.1.

21 **106.5.5 Information on first sheet.** The first or general note sheet of each set of plans shall
22 specify the following, as applicable:

23 1. The building and street address of the work.

- 1 2. The name and address of the owner and person who prepared the plans.
- 2 3. Legal description of the property.
- 3 4. Type of occupancy of all parts of the building(s) as defined in this code, including
- 4 notation of fixed fire protection devices or systems.
- 5 5. Zoning classification of the property and existing and proposed uses of the
- 6 structure(s) as defined in the Land Use Code.
- 7 6. Indication of location within the fire district as defined in this code, if applicable.
- 8 7. Type of construction as defined in this code.
- 9 8. Number of stories and basements as defined in this code.
- 10 9. Variances, conditional uses, special exceptions, including project numbers,
- 11 approval and approval extension dates.
- 12 10. Where applicable, a description of the design selected and approved at a Section
- 13 403 high-rise building pre-design conference, a Section 404 atrium pre-design
- 14 conference, a Section 414.1.4 hazardous occupancy pre-design conference, a
- 15 Section 1613.1.1 seismic design pre-design conference or a similar conference on
- 16 a building subject to Fire Code Chapter 93.

17 **106.5.6 Structural notes.** Plans shall include applicable information including, but not
18 limited to, the following:

- 19 1. Design loads: Snow load, live loads and lateral loads. If required by the building
- 20 official, the structural notes for plans engineered to ASCE 7 shall include the
- 21 factors of the base shear formula used in the design;
- 22 2. Foundations: Foundation investigations, allowable bearing pressure for spread
- 23 footings, allowable load capacity of piles, lateral earth pressure;

- 1 3. Masonry: Type and strength of units, strength or proportions of mortar and grout,
- 2 type and strength of reinforcement, method of testing, design strength;
- 3 4. Wood: Species or species groups, and grades of sawn lumber, glued-laminated
- 4 lumber, plywood and assemblies, type of fasteners;
- 5 5. Concrete: Design strengths, mix designs, type and strength of reinforcing steel,
- 6 welding of reinforcing steel, restrictions, if any;
- 7 6. Steel and aluminum: Specification types, grades and strengths, welding electrode
- 8 types and strengths.

9 In lieu of detailed structural notes the building official may approve minor references
10 on the plans to a specific section or part of this code or other ordinances or laws.

11 **106.5.7 Fire-resistive notes.** The building official may require that plans for buildings more
12 than two stories in height of other than Groups R-3 and U occupancies indicate how required
13 structural and fire-resistive integrity will be maintained where a penetration will be made for
14 electrical, mechanical, plumbing and communication conduits, pipes and similar systems.

15 The building official may require that, when required for fire-resistive construction, the
16 method of installation of wall and ceiling coverings and the protection of structural parts be
17 specified on the plans unless the listing that documents the rating specifies a method no more
18 restrictive than the minimum standards of Chapter 7.

19 **106.5.8 Deferred submittals.** Deferral of any submittal items shall have the prior approval
20 of the building official. The registered design professional in responsible charge shall list
21 deferred submittals on the plans for review by the building official.

22 Documents for deferred submittal items shall be submitted to the registered design
23 professional in responsible charge who shall review them and forward them to the building

1 official with a notation indicating that the deferred submittal documents have been reviewed
2 and been found to be in general conformance to the design of the building. The deferred
3 submittal items shall not be installed until the deferred submittal documents have been
4 approved by the building official.

5 **106.5.9 Construction and demolition waste.** The information in Sections 106.5.9.1 and
6 106.5.9.2 shall be submitted for projects generating construction or demolition material for
7 salvage, recycling or disposal.

8 **Exception:** Projects for which an emergency order or hazard correction order has
9 been issued pursuant to Section 102.

10 **106.5.9.1 Application submittal requirements.** The following information shall be
11 provided at the time of application for *building alterations* and the demolition of *existing*
12 *buildings* having a work area greater than 750 square feet or a project value greater than
13 \$75,000, whichever is more restrictive:

- 14 1. A salvage assessment completed by an approved agency identifying building
15 components having potential to be salvaged prior to building removal. The
16 building owner is permitted to complete the assessment for building
17 alterations that include some demolition.
- 18 2. A statement of compliance with the regulations of the Puget Sound Clean Air
19 Agency regarding asbestos identification, notification and abatement.

20 **106.5.9.2 Waste Diversion Report.** A Waste Diversion Report shall be submitted within
21 60 days of final inspection approval. The Waste Diversion Report shall identify the
22 weight or volume of project-generated construction waste and demolition material, the
23 hauler of the material, and the receiving facility or location for each commodity. A

1 signed affidavit from the receiving party and photo documentation shall be included for
2 salvaged materials for which a tip receipt cannot be obtained.

3 **106.5.10 Clarity of plans.** Plans shall be drawn to a clearly indicated and commonly
4 accepted scale in a format determined by the building official.

5 **106.6 Application review and permit issuance.** The construction documents shall be reviewed
6 by the building official. Such construction documents may be reviewed by other departments of
7 the City to check compliance with the laws and ordinances under their jurisdiction.

8 **106.6.1 Determination of completeness.** Within 28 days after an application is filed, the
9 building official shall notify the applicant in writing either that the application is complete or
10 that it is not complete, and if not complete, what additional information is required to make it
11 complete. Within 14 days after receiving the additional information, the building official
12 shall notify the applicant in writing whether the application is now complete or what
13 additional information is necessary. An application shall be deemed to be complete if the
14 building official does not notify the applicant in writing by the deadlines in this section that
15 the application is incomplete.

16 **106.6.2 Decision on application.** Except as provided in Section 106.6.8, the building
17 official shall approve, condition or deny the application within 120 days after the building
18 official notifies the applicant that the application is complete.

19 To determine the number of days that have elapsed after the notification that the
20 application is complete, the following periods shall be excluded:

- 21 1. All periods of time during which the applicant has been requested by the Director to
22 correct plans, perform required studies, or provide additional required information,
23 until the determination that the request has been satisfied. The period shall be

1 calculated from the date the building official notifies the applicant of the need for
2 additional information until the earlier of the date the building official determines
3 whether the additional information satisfies the request for information or 14 days
4 after the date the information has been provided to the building official.

5 2. If the building official determines that the information submitted by the applicant
6 under item 1 of this subsection is insufficient, the building official shall notify the
7 applicant of the deficiencies, and the procedures under item 1 of this subsection shall
8 apply as if a new request for information had been made;

9 3. All extensions of time mutually agreed upon by the applicant and the building
10 official.

11 If a project permit application is substantially revised by the applicant, the time period
12 shall start from the date at which the revised project application is determined to be
13 complete under Section 101.3.1.

14 **106.6.3 Issuance of permit.**

15 **106.6.3.1.** Subject to Section 106.6.3.2, the building official shall issue a permit to the
16 applicant if the building official finds the following:

- 17 1. The work described in the construction documents conforms to the requirements
18 of this code and other pertinent laws, ordinances, and regulations and with all
19 conditions imposed under any of them,
20 2. The fees specified in the Fee Subtitle have been paid, and
21 3. The applicant has complied with all requirements to be performed prior to
22 issuance of a permit for the work under other pertinent laws, ordinances or

1 regulations or included in a master use permit, or otherwise imposed by the
2 building official.

3 When the permit is issued, the applicant or the applicant's authorized agent becomes
4 the permit holder.

5 **106.6.3.2** The building official shall not issue a permit if the building official has
6 determined that the property owner violated subsection 22.210.136.A of the Seattle
7 Municipal Code and the owner has not obtained any required tenant relocation license.

8 **106.6.4 Phased permits.**

- 9 1. The building official may authorize construction of a portion or portions of a building
10 or structure before complete construction documents for the whole building or
11 structure have been submitted or approved, or before the applicant has complied with
12 all conditions of a building permit for the entire building or structure under the Land
13 Use Code or master use permit. The entire proposed project shall comply with
14 applicable city law in effect on the date set forth in Section 101.3.

15 The applicant shall proceed at the applicant's risk without assurance that a permit
16 for the entire building or structure will be granted.

- 17 2. After approval of a Master Use Permit as required by the Land Use Code, if the
18 applicant has satisfied all applicable requirements for issuance of a grading permit
19 under the Grading Code and rules adopted thereunder, a permit for excavation,
20 shoring and other land-disturbing activity may be issued.

21 **106.6.5 Grading permits.** The grading component of the building permit is the portion of
22 the building permit that authorizes work that is subject to the requirements of the Grading
23 Code. That component constitutes a grading permit.

1 **106.6.6 Permit conditions and denial.** The building official may impose on a permit any
2 conditions authorized by this code or other pertinent ordinances or regulations, including but
3 not limited to the Grading Code, the Stormwater Code, Regulations for Environmentally
4 Critical Areas, and rules adopted pursuant to those codes. In addition, the building official
5 may condition a permit in order to reduce the risks associated with development,
6 construction, ownership and occupancy including, but not limited to risks in potential slide
7 areas. The building official may deny a permit if the building official determines that the
8 risks cannot be reduced to an acceptable level, that the proposed project or construction
9 documents do not conform to the requirements of this code or other pertinent laws,
10 ordinances or regulations, or to requirements included in the Master Use Permit or
11 requirements otherwise imposed by the building official or other City departments, or that the
12 applicant has failed to comply with any requirement or condition imposed pursuant to the
13 authority described above.

14 **106.6.7 Compliance with approved construction documents.** When the building official
15 issues a permit, the building official shall endorse the permit in writing or in electronic
16 format, and stamp the plans APPROVED. Such approved plans and permit shall not be
17 changed, modified or altered without authorization from the building official, and all work
18 shall be done in accordance with the approved construction documents and permit except as
19 authorized by the building official during a field inspection to correct errors or omissions or
20 as authorized by Section 106.6.8.

21 **106.6.8 Revisions to the permit.** When changes to the approved work are made during
22 construction, approval of the building official shall be obtained prior to execution. The
23 building inspector may approve minor changes to the construction documents for work not

1 reducing the structural strength or fire and life safety of the structure. The building inspector
2 shall determine if it is necessary to revise the approved construction documents. No changes
3 that are subject to special inspection required by Section 1704 shall be made during
4 construction unless approved by the building official. If revised plans are required, changes
5 shall be submitted to and approved by the building official, accompanied by fees specified in
6 the Fee Subtitle prior to occupancy. All changes shall conform to the requirements of this
7 code and other pertinent laws and ordinances and other issued permits.

8 **106.6.9 Cancellation of permit applications.** Applications may be cancelled if no permit is
9 issued by the earlier of the following: (1) twelve months following the date of application; or
10 (2) sixty days from the date of written notice that the permit is ready to issue. After
11 cancellation, construction documents submitted for review may be returned to the applicant
12 or destroyed by the building official.

13 The building official will notify the applicant in writing at least thirty days before the
14 application is cancelled. The notice shall specify a date by which a request for extension
15 must be submitted in order to avoid cancellation. The date shall be at least two weeks prior
16 to the date on which the application will be cancelled.

17 **106.6.10 Extensions prior to permit issuance.** At the discretion of the building official,
18 applications for projects that require more than 12 months to review and approve may be
19 extended for a period that provides reasonable time to complete the review and approval, but
20 in no case longer than 24 months from the date of the original application. No application
21 may be extended more than once. After cancellation, the applicant shall submit a new
22 application and pay a new fee to restart the permit process.

1 Notwithstanding other provisions of this code, applications may be extended where
2 issuance of the permit is delayed by litigation, preparation of environmental impact
3 statements, appeals, strikes or other causes related to the application that are beyond the
4 applicant's control, or while the applicant is making progress toward issuance of a master use
5 permit.

6 **106.7 Retention of plans.** One set of approved plans, which may be on microfilm or in
7 electronic format, shall be retained by the building official. One set of approved plans shall be
8 returned to the applicant and shall be kept at the site of the building or work for use by inspection
9 personnel at all times during which the work authorized is in progress.

10 **106.8 Validity of permit.** The issuance or granting of a permit or approval of construction
11 documents shall:

- 12 1. Not be construed to be a permit for, or an approval of, any violation of any of the provisions
13 of this code or other pertinent laws and ordinances;
- 14 2. Not prevent the building official from requiring the correction of errors in the construction
15 documents or from preventing building operations being carried on thereunder when in
16 violation of this code or of other pertinent laws and ordinances of the City;
- 17 3. Not prevent the building official from requiring correction of conditions found to be in
18 violation of this code or other pertinent laws and ordinances of the City; or
- 19 4. Not be construed to extend the period of time for which any such permit is issued or
20 otherwise affect any period of time for compliance specified in any notice or order issued by
21 the building official or other administrative authority requiring the correction of any such
22 conditions.

1 **106.9 Expiration of permits.** Authority to do the work authorized by a permit expires 18
2 months from the date of issuance. An approved renewal extends the life of a permit for an
3 additional 18 months from the prior expiration date. An approved reestablishment extends the
4 life of the permit for 18 months from the date the permit expired.

5 **Exceptions:**

- 6 1. Initial permits for major construction projects that require more than 18 months to
7 complete may be issued for a period that provides reasonable time to complete the
8 work, according to an approved construction schedule. The building official may
9 authorize a permit expiration date not to exceed three years from the date of issuance,
10 except when there is an associated Shoreline Substantial Development permit in
11 which case the building official may authorize an expiration date not to exceed the
12 life of the Shoreline permit.
- 13 2. The building official may issue permits which expire in less than eighteen months if
14 the building official determines a shorter period is appropriate to complete the work.

15 This section is subject to the limitations in Seattle Municipal Code Section 22.800.100,
16 Stormwater Code.

17 **106.10 Renewal of permits.** Permits may be renewed and renewed permits may be further
18 renewed by the building official if the following conditions are met:

- 19 1. Application for renewal is made within the 30 day period immediately preceding the date
20 of expiration of the permit; and
- 21 2. If the project has had an associated discretionary Land Use review, the land use approval
22 has not expired; and

- 1 3. If an application for renewal is made more than 18 months after the date of mandatory
2 compliance with a new or revised edition of the Seattle Building Code, the permit shall
3 not be renewed unless:
- 4 3.1 The building official determines that the permit complies, or is modified to
5 comply, with the Seattle Building, Mechanical, Fuel Gas, Energy, Stormwater,
6 Side Sewer and Grading codes in effect on the date of application for renewal; or
- 7 3.2 The work authorized by the permit is substantially underway and progressing at a
8 rate approved by the building official. “Substantially underway” means that
9 normally required building inspections have been approved for work such as
10 foundations, framing, mechanical, insulation and finish work that is being
11 completed on a continuing basis; or
- 12 3.3. Commencement or completion of the work authorized by the permit is delayed by
13 litigation, appeals, strikes or other extraordinary circumstances related to the work
14 authorized by the permit, beyond the permit holder's control, subject to approval
15 by the building official; and
- 16 4. If an application for renewal is made on or after January 1, 2017, the permit shall not be
17 renewed unless: (a) the *building official* determines that the permit complies, or is
18 modified to comply, with the Seattle Stormwater Code in effect on the date of application
19 for renewal; or (b) construction has started. For purposes of this provision, “started
20 construction” means the site work associated with and directly related to the *approved*
21 project has begun. For example, grading the project site to final grade or utility
22 installation constitutes the start of construction; simply clearing the project site does not.

1 **106.11 Reestablishment of expired permits.** A new permit is required to complete work if a
2 permit has expired and was not renewed.

3 **Exception:** A permit that expired less than one year prior to the date of a request for
4 reestablishment may be reestablished upon approval of the building official if it complies
5 with Section 106.10, Items 2, 3, and 4 above. Once re-established the permit will not be
6 considered to have expired. The new expiration date of a reestablished permit shall be
7 determined in accordance with Section 106.9.

8 **106.12 Revocation of building permits.** Whenever the building official determines there are
9 grounds for revoking a permit, the building official may issue a notice of revocation. The notice
10 of revocation shall identify the reason for the proposed revocation, including but not limited to,
11 the violations, the conditions violated, and any alleged false or misleading information provided.

12 **106.12.1 Standards for revocation.** The building official may revoke a permit if:

- 13 1. The code or the building permit has been or is being violated and issuance of a
14 notice of violation or stop work order has been or would be ineffective to secure
15 compliance because of circumstances related to the violation; or
- 16 2. The permit was obtained with false or misleading information.

17 **106.12.2 Service of notice of revocation.** The notice of revocation shall be served upon the
18 owner, agent or other responsible person by personal service or regular first class mail
19 addressed to the last known address of such person or if no address is available after
20 reasonable inquiry, the notice may be posted in a conspicuous place on the premises. The
21 notice may also be posted if served by personal service or first class mail.

1 **106.12.3 Effective date of revocation.** The building official shall identify in the notice of
2 revocation a date certain on which the revocation will take effect. This date may be stayed
3 pending complete review by the building official pursuant to Section 106.12.4.

4 **106.12.4 Review by the building official for notice of revocation.** Any person aggrieved
5 by a notice of revocation may obtain a review by making a request in writing to the building
6 official within three business days of the date of service of the notice of revocation. The
7 review shall occur within five business days after receipt by the building official of the
8 request for review. Any person affected by the notice of revocation may submit additional
9 information to the building official for consideration as part of the review at any time prior to
10 the review.

11 **106.12.4.1 Review procedure.** The review will be made by a representative of the
12 building official who will review all additional information received and may also request
13 a site visit. After the review, the building official may:

- 14 1. Sustain the notice of revocation and affirm or modify the date the revocation will
15 take effect;
- 16 2. Withdraw the notice of revocation;
- 17 3. Modify the notice of revocation and affirm or modify the date the revocation will
18 take effect; or
- 19 4. Continue the review to a date certain.

20 **106.12.4.2 Order of revocation of permit.** The building official shall issue an order
21 containing the decision within ten days after the review is completed and shall cause the
22 same to be sent by regular first class mail to the person or persons requesting the review,
23 any other person on whom the notice of revocation was served and any other person who

1 requested a copy before issuance of the order. The order of the building official is the
2 final order of the City, and the City and all parties shall be bound by the order.

3 **106.13 Permits for temporary structures.**

4 **106.13.1 Tents and similar facilities used for 18 months or less.** The building official may
5 issue a permit to erect and maintain a tent or other similar temporary structure to be used for
6 religious services, conventions, circuses, carnivals, fairs, special sales or similar uses for a
7 period not to exceed eighteen months.

8 **Exceptions:**

9 1. Authority to issue permits is vested with the Fire Department for temporary tents and
10 canopies meeting all of the following conditions:

11 1.1. The permit is for less than four weeks;

12 1.2. The temporary structure will be located 200 feet or more from shorelines;

13 1.3. No stage, platform, bleacher or similar structure greater than 4 feet in height
14 will be installed inside any temporary structure;

15 1.4. No temporary structure will be attached to a building or other permanent
16 structure for support;

17 1.5. The temporary structure is not proposed to be used during severe weather, and

18 1.6. The temporary structure is not of unusual shape, unusual location or large
19 area or height.

20 **Note:** The Land Use and Fire codes may impose additional restrictions or conditions on tents
21 and temporary structures.

22 **106.13.1.1 Renewal.** Permits issued pursuant to Section 106.13.1 are not renewable.

1 **106.13.1.2 Subsequent permits.** If the occupant load of the structure is 100 or more and
2 is issued for less than 4 weeks, no more than one permit per tent vendor for each event
3 shall be issued in any three-month period.

4 **106.13.1.3 Removal.** Such structures shall be removed before the expiration of the
5 permit.

6 **106.13.1.4 Requirements for tents and similar structures.** The structure shall be
7 subject to such reasonable safeguards for persons and property as the building official
8 prescribes. The nature and extent of fire-extinguishing equipment and decorations shall
9 be subject to the requirements of the fire chief, and the sanitary facilities shall meet the
10 requirements of the Director of Public Health.

11 **106.13.1.5 Cash deposit or bond.** The building official may require that removal of the
12 structure be guaranteed by a cash deposit with the building official or by a surety bond,
13 the amount of which, in either case, shall be fixed by the building official. The cash
14 deposit or bond shall also be conditioned so that, if the occupant or owner fails to
15 conform to any of the requirements of the City related to the erection, maintenance or
16 removal of the tent or other structure, the building official may enter the premises and
17 take steps necessary to make the structure conform to the requirements. The City shall be
18 permitted to recover the cost thereof from the cash deposit or bond.

19 **106.13.2 Temporary structures.** Temporary structures such as reviewing stands and other
20 structures conforming to the requirements of this code, and sheds, canopies, or fences used
21 for the protection of the public around and in conjunction with construction work may be
22 erected by special permit from the building official for a limited period of time. The building

1 or structure shall be subject to the bonding, removal and safety provisions of Section
2 106.13.1.5.

3 **106.13.3 Temporary structures in the right-of-way.** Temporary buildings or structures in
4 the right-of-way are regulated by the Director of Transportation.

5 **106.13.4 Temporary commercial coaches and modular homes.** The building official may
6 issue permits for eighteen months for the installation of commercial coaches and modular
7 homes as temporary offices or other uses as may be determined by the building official,
8 subject to the following:

9 1. Commercial coach shall be identified by a State of Washington black sticker located
10 by the door. The structure may be placed on a temporary foundation and shall be
11 anchored to resist wind and seismic lateral forces.

12 2. Modular homes shall be identified by a State of Washington gold sticker located by
13 the door. Modular homes shall be permitted only if no heavy storage is anticipated
14 for the temporary office use. The structure may be placed on a temporary foundation
15 and shall be anchored to resist wind and seismic lateral forces.

16 3. A plot plan shall be submitted to verify compliance with the Land Use Code and to
17 check exposure to other buildings.

18 4. The proposed use must be permitted outright under the Land Use Code and comply
19 with all other pertinent laws and ordinances.

20 5. Construction offices, dry shacks and similar temporary buildings are regulated by
21 Section 106.13.5.

22 **106.13.4.1 Renewal of temporary commercial coach and modular home permits.** A
23 subsequent permit for another 18 months may be issued at the end of each 18 month period if

1 the building official determines that the commercial coach or modular home complies with
2 this section.

3 **106.13.5 Construction buildings.** The building official may issue a permit to erect and
4 maintain construction offices, dry shacks and similar temporary buildings, including material
5 and equipment storage, for the purpose of constructing an improvement.

6 **Exception:** A temporary permit is not required for construction offices and similar
7 temporary buildings located on the same premises for which a construction permit has
8 been issued.

9 **106.13.5.1 Removal of construction buildings.** Such structures shall be removed within 14
10 days after the end of the temporary permit's term. Removal shall be guaranteed by a cash
11 deposit with the building official or by a surety bond, the amount of which, in either case,
12 shall be fixed by the building official.

13 **106.13.5.2 Requirements for construction buildings.** The construction of the structure shall
14 be subject to reasonable safeguards for persons and property as the building official shall
15 prescribes; the nature and extent of fire-extinguishing equipment shall be subject to the
16 requirements of the fire chief, and the sanitary facilities shall meet the requirements of the
17 Director of Public Health.

18 **106.13.5.3 Cash deposit or bond.** The building official may require that removal of the
19 structure be guaranteed by a cash deposit with the building official or by a surety bond, the
20 amount of which, in either case, shall be fixed by the building official. The cash deposit or
21 bond shall be conditioned so that, if the occupant or owner fails to conform to any of the
22 requirements of the City related to the erection, maintenance or removal of the tent or other
23 structure, the building official may enter the premises and take steps necessary to make the

1 structure conform to the requirements. The City shall be permitted to recover the cost thereof
2 from the cash deposit or bond.

3 SECTION 107

4 FLOOR AND ROOF DESIGN LOADS

5 **107.1 Live loads posted.** Where the live loads for which each floor or portion thereof of a
6 commercial or industrial building is or has been designed to exceed 125 pounds per square foot
7 and for all warehouse and storage areas, such design live loads shall be conspicuously posted by
8 the owner or the owner's authorized agent in that part of each story in which they apply, using
9 durable signs. It shall be unlawful to remove or deface such notices.

10 **107.2 Issuance of certificate of occupancy.** A certificate of occupancy required by Section 109
11 shall not be issued until the floor load signs, required by Section 107.1, have been installed.

12 **107.3 Restrictions on loading.** It shall be unlawful to place, or cause or permit to be placed, on
13 any floor or roof of a building, structure or portion thereof, a load greater than is permitted by
14 this code.

15 SECTION 108

16 INSPECTIONS

17 **108.1 General.** All construction or work for which a permit is required is subject to inspection
18 by the building official, and certain types of construction shall have special inspections by
19 registered special inspectors as specified in Chapter 17.

20 **108.2 Surveys.** A survey of the lot may be required by the building official to verify
21 compliance of the structure with approved construction documents.

22 **108.3 Preconstruction conferences.** When required by the building official, the owner or the
23 owner's agent shall arrange a conference with the project contractor, the design team, the special

1 inspection agency if special inspection is required, and the building official prior to commencing
2 work on any portion of construction. The intent of the conference is to identify and clarify
3 unusual inspection requirements of the project. See Section 1703.7 for preconstruction
4 conferences for projects requiring special inspection.

5 **108.4 Inspection requests.** The owner of the property or the owner's authorized agent, or the
6 person designated by the owner or agent to do the work authorized by a permit shall notify the
7 building official that work requiring inspection as specified in this section and Chapter 17 is
8 ready for inspection.

9 **108.5 Access for inspection.** The permit holder and the person requesting any inspections
10 required by this code shall provide access to and means for proper inspection of such work,
11 including safety equipment required by Washington Industrial Safety and Health Agency. The
12 work shall remain accessible and exposed for inspection purposes until approved by the building
13 official. Neither the building official nor the City shall be liable for expense entailed in the
14 required removal or replacement of any material to allow inspection.

15 **108.6 Inspection record.** Work requiring a permit shall not be commenced until the permit
16 holder or the permit holder's agent has posted an inspection record in a conspicuous place on the
17 premises and in a position that allows the building official to conveniently make the required
18 entries regarding inspection of the work. This record shall be maintained in such a position by
19 the permit holder or the permit holder's agent until final approval has been granted by the
20 building official.

21 **108.7 Approvals required.** No work shall be done on any part of the building or structure
22 beyond the point indicated in each successive inspection without first obtaining the written
23 approval of the building official. Written approval shall be given only after an inspection has

1 been made of each successive step in the construction as indicated by each of the inspections
2 required in Section 108.9. There shall be a final inspection and approval of all buildings when
3 completed and ready for occupancy.

4 **108.7.1 Effect of approval.** Approval as a result of an inspection is not an approval of any
5 violation of the provisions of this code or of other pertinent laws and ordinances of the City.
6 Inspections presuming to give authority to violate or cancel the provisions of this code or of
7 other pertinent laws and ordinances of the City are not valid.

8 **108.8 Concealment of work.** No required reinforcing steel or structural framework of any part
9 of any building or structure shall be covered or concealed in any manner whatsoever without first
10 obtaining the approval of the building official. Protection of joints and penetrations in fire-
11 resistance-rated assemblies, smoke barriers and smoke partitions shall not be concealed from
12 view until inspected and approved.

13 **Exception:** Modular homes and commercial coaches identified by State of Washington
14 stickers as specified in Section 106.13.4 and placed upon a permanent foundation approved
15 and inspected by the building official.

16 **108.9 Required inspections.** The building official, upon notification by the permit holder or
17 the permit holder's agent, of the property address and permit number, shall make the following
18 inspections and shall either approve that portion of the construction as completed or shall notify
19 the permit holder or the permit holder's agent if the construction fails to comply with the law.

20 **108.9.1 First ground disturbance inspection.** To be made prior to beginning land-
21 disturbing activity, and following installation of erosion control measures and any required
22 fencing that may restrict land disturbance in steep slope or other buffers as defined in Seattle
23 Municipal Code Chapter 25.09.

1 **Note:** The purpose of the site inspection is to verify the erosion control method, location
2 and proper installation. Approved drainage plan requirements and site plan conditions
3 will also be verified, including buffer delineations.

4 **108.9.2 Foundation inspection.** To be made after trenches are excavated and forms erected
5 and when all materials for the foundation are delivered on the job. Where concrete from a
6 central mixing plant (commonly termed “ready mix”) is to be used, materials need not be on
7 the job.

8 **108.9.3 Concrete slab or under-floor inspection.** To be made after all in-slab or under-
9 floor building service equipment, conduit, piping accessories and other ancillary equipment
10 items are in place but before any concrete is poured or floor sheathing installed, including the
11 subfloor.

12 **108.9.4 Lowest floor elevation.** In flood hazard areas, upon placement of the lowest floor,
13 including the basement, and prior to further vertical construction, the elevation certification
14 required in Section 1612.5 shall be submitted to the building official.

15 **108.9.5 Frame inspection.** To be made after the roof, all framing, fire-blocking and bracing
16 are in place and all pipes, chimneys and vents are complete and the rough electrical,
17 plumbing, and heating wires, pipes and ducts are approved.

18 **108.9.6 Insulation inspection.** To be made after all insulation and vapor barriers are in
19 place but before any gypsum board or plaster is applied.

20 **108.9.7 Lath and/or gypsum board inspection.** For shear walls, to be made after lathing
21 and/or gypsum board, interior and exterior, is in place, but before any plastering is applied or
22 before gypsum board joints and fasteners are taped and finished.

1 **108.9.8 Final site inspection.** To be made after all grading is complete, and all permanent
2 erosion controls, stormwater facilities and stormwater best management practices have been
3 installed.

4 **Exception:** A final site inspection is not required for projects with less than 750 square
5 feet of land disturbing activity.

6 **108.9.9 Final inspection.** To be made after finish grading and the building is completed and
7 before occupancy.

8 **108.9.9.1 Flood hazard documentation.** If located in a flood hazard area, documentation of
9 the elevation of the lowest floor as required in Section 1612.5 shall be submitted to the
10 building official prior to the final inspection.

11 **108.10 Special inspections.** For special inspections, see Chapter 17.

12 **108.11 Other inspections.** In addition to the called inspections specified above, the building
13 official may make or require any other inspections of any construction work or site work to
14 ascertain compliance with the provisions of this code and other pertinent laws and ordinances
15 that are enforced by the building official.

16 **108.12 Special investigation.** If work that requires a permit or approval is commenced or
17 performed prior to making formal application and receiving the building official's permission to
18 proceed, the building official may make a special investigation inspection before a permit is
19 issued for the work. Where a special investigation is made, a special investigation fee may be
20 assessed in accordance with the Fee Subtitle.

21 **108.13 Reinspections.** The building official may require a reinspection if work for which
22 inspection is called is not complete, required corrections are not made, the inspection record is
23 not properly posted on the work site, the approved plans are not readily available to the

1 inspector, access is not provided on the date for which inspection is requested, or if deviations
2 from construction documents that require the approval of the building official have been made
3 without proper approval, or as otherwise required by the building official.

4 **108.13.1 Compliance with International Existing Building Code Section 101.5.** For the
5 purpose of determining compliance with International Existing Building Code Section 101.5,
6 Maintenance, the building official or the fire chief may cause any structure to be reinspected.

7 **108.13.2 Reinspection fee.** The building official may assess a reinspection fee as set forth in
8 the Fee Subtitle for any action for which reinspection is required. In instances where
9 reinspection fees have been assessed, no additional inspection of the work will be performed
10 until the required fees have been paid.

11 SECTION 109

12 CERTIFICATE OF OCCUPANCY

13 **109.1 Occupancy.** No new building or structure shall be used or occupied until the building
14 official has issued a Certificate of Occupancy. For existing buildings, a Certificate of Occupancy
15 is required for:

- 16 1. *Any change of occupancy,*
- 17 2. Change in type of construction,
- 18 3. Addition, removal or change in type of a fire sprinkler system,
- 19 4. Changes in occupant load of an assembly occupancy,
- 20 5. Change in the number of dwelling units.

21 **Exception:** Certificates of occupancy are not required for:

- 1 1. Detached Group R-3 occupancies and Group U occupancies accessory to them,
2 provided they shall not be used or occupied until approved for occupancy after final
3 inspection.
- 4 2. Work exempt from permits under Section 106.2.
- 5 3. Work for which a temporary permit was issued under Section 106.13.

6 **109.1.1 Effect of Certificate of Occupancy.** Issuance of a Certificate of Occupancy is not
7 approval of any violation of the provisions of this code or other pertinent laws and
8 ordinances of the City. Certificates presuming to give authority to violate or cancel the
9 provisions of this code or of other pertinent laws and ordinances of the City are not valid.

10 **109.2 Change in occupancy.** Changes in the occupancy of a building shall not be made except
11 as specified in the International Existing Building Code.

12 **109.3 Certificate issued.** After satisfactory completion of inspections, if the building official
13 finds that the building or structure requiring a Certificate of Occupancy complies with the
14 provisions of this code, the Fire Code, other pertinent laws, ordinances and regulations of the
15 City, and with all conditions imposed under any of them, and that the applicant has complied
16 with all requirements to be performed prior to issuance of a Certificate of Occupancy in other
17 pertinent laws, ordinances or regulations or in a Master Use Permit, or otherwise imposed by the
18 building official or by another City department under any pertinent laws, ordinances or
19 regulations, then the building official shall issue a Certificate of Occupancy which shall contain
20 the following information:

- 21 1. The building permit number;
- 22 2. The address of the building;
- 23 3. A description of that portion of the building for which the certificate is issued;

- 1 4. A statement that the described portion of the building has been inspected for compliance
- 2 with the requirements of this; and
- 3 5. The name of the building official.

4 **109.4 Temporary certificate.** A Temporary Certificate of Occupancy may be issued by the
5 building official for the use of a portion or portions of a building or structure prior to the
6 completion of the entire building or structure if all devices and safeguards for fire protection and
7 life safety, as required by this code, the Fire Code, and other pertinent laws and ordinances of the
8 City, are maintained in a safe and usable condition.

9 **109.5 Posting.** A Certificate of Occupancy shall be posted in a conspicuous place on the
10 premises and shall not be removed except by the building official.

11 **109.6 Suspension or revocation of Certificates of Occupancy.**

12 **109.6.1 Notice of suspension or revocation.** Whenever the building official determines
13 there are grounds for suspending or revoking a Certificate of Occupancy, the building official
14 may issue a notice of revocation. The notice shall state the reason for suspension or
15 revocation, and shall set the date that the suspension or revocation will take effect if
16 compliance is not achieved by the date set in the notice, which shall be a reasonable time for
17 compliance.

18 **109.6.2 Standards for suspension or revocation of Certificates of Occupancy.** The
19 building official may suspend or revoke a Certificate of Occupancy if:

- 20 1. The certificate is issued in error or on the basis of incorrect information supplied; or
- 21 2. It is determined that the building or structure or portion thereof is in violation of any
- 22 pertinent laws or ordinances of the City or any of the provisions of this code; or

1 3. When the building, site, applicant, or owner is in violation of any requirement or
2 condition imposed by or pursuant to any other pertinent laws or ordinances of the
3 City that provide for suspension or revocation of a Certificate of Occupancy.

4 **109.6.3 Service of notice of suspension or revocation.** The notice of suspension or
5 revocation shall be served upon the owner, agent or other responsible person by personal
6 service or regular first class mail addressed to the last known address of such person or if no
7 address is available after reasonable inquiry, the notice may be posted in a conspicuous place
8 on the premises. The notice may also be posted if served by personal service or first class
9 mail.

10 **109.6.4 Effect of notice of suspension or revocation.** The notice shall be considered an
11 order of the building official if no request for review before the building official is made
12 pursuant to Section 109.6.5. Nothing in this subsection shall be deemed to limit or preclude
13 any action or proceeding pursuant to Sections 102 or 103 of this code.

14 **109.6.5 Review of suspension or revocation of Certificate of Occupancy by the building**
15 **official.** Any person affected by a notice of revocation issued pursuant to Section 109.6 may
16 obtain a review of the notice by making a request in writing within ten days after service of
17 the notice. When the last day of the period computed is a Saturday, Sunday, or city holiday,
18 the period shall run until 5 p.m. of the next business day.

19 **109.6.5.1 Review procedure.** The review shall occur not less than ten nor more than 20
20 days after the request is received by the building official unless otherwise agreed by the
21 person requesting the review. Any person affected by the notice of revocation may
22 submit additional information to the building official. The review shall be made by a
23 representative of the building official who will review any additional information that is

1 submitted and the basis for issuance of the notice of suspension or revocation. The
2 reviewer may request clarification of the information received and a site visit.

3 **109.6.5.2 Decision.** After the review, the building official shall:

- 4 1. Sustain the notice;
- 5 2. Withdraw the notice;
- 6 3. Amend the notice; or
- 7 4. Continue the review to a date certain

8 **109.6.5.3 Order.** The building official shall issue an order containing the decision within
9 15 days of the date that the review is completed and shall cause the order to be mailed by
10 regular first class mail to the persons requesting the review and the persons named on the
11 notice of violation addressed to their last known address.

12 SECTION 110

13 FEES

14 **110.1 Fees.** A fee for each building permit and for other activities related to the enforcement of
15 this code shall be paid as set forth in the Fee Subtitle.

16 Section 3. The following sections of Chapter 2 of the International Building Code, 2015
17 Edition, are amended as follows:

18 CHAPTER 2

19 DEFINITIONS

20 SECTION 201

21 GENERAL

22 ***

1 **201.1 Terms defined in other codes.** Where terms are not defined in this code and are defined
2 in the International Energy Conservation Code, International Existing Building Code,
3 International Fuel Gas Code, International Fire Code, International Mechanical Code or
4 ((International)) Uniform Plumbing Code, such terms shall have the meanings ascribed to them
5 as in those codes.

6 ***

7 **201.5 References to other codes.** Whenever an International, National or Uniform Code is
8 referenced in this code, it shall mean the Seattle edition of that code, including any local
9 amendments. References to the “Building Code,” “Fire Code,” “Mechanical Code” and “Plumbing
10 Code” mean the Seattle editions of those codes.

11 SECTION 202

12 DEFINITIONS

13 ***

14 **[W] ADULT FAMILY HOME.** A dwelling licensed by the state of Washington in which a person
15 or persons provide personal care, special care, room and board to more than one but not more than
16 six adults who are not related by blood or marriage to the person or persons providing the services.

17 ***

18 **[W] ASSISTED LIVING FACILITY.** A home or other institution, licensed by the state of
19 Washington, providing housing, basic services and assuming general responsibility for the safety
20 and well-being of residents under chapters 18.20 RCW and 388-78A WAC. These facilities may
21 provide care to residents with symptoms consistent with dementia requiring additional security
22 measures.

23 ***

1 AWNING. A protective covering with a nonrigid surface projecting from a building. ((An
2 architectural projection that provides weather protection, identity or decoration and is partially or
3 wholly supported by the building to which it is attached. An awning is comprised of a lightweight
4 frame structure over which a covering is attached.))

5 AWNING SIGN. A sign applied to the surface of an awning or canopy.

6 ***

7 [W] BOTTLE FILLING STATION. A plumbing fixture connected to the potable water
8 distribution system and sanitary drainage system that is designed and intended for filling personal
9 use drinking water bottles or containers not less than 10 inches (254 mm) in height. Such fixtures
10 can be separate from or integral to a drinking fountain and can incorporate a water filter and a
11 cooling system for chilling the drinking water.

12 ***

13 [A] BUILDING OFFICIAL. The ((officer or other designated authority charged with the
14 administration and enforcement of this code.)) Director of the Seattle Department of
15 Construction and Inspections, or a duly authorized representative.

16 ***

17 CANOPY. ((A permanent structure or architectural projection of rigid construction over which a
18 covering is attached that provides weather protection, identity or decoration. A canopy is
19 permitted to be structurally independent or supported by attachment to a building on one or more
20 sides.)) A protective covering with a rigid surface projecting from a building. Marquees are a
21 type of canopy.

22 CANOPY SIGN. A sign applied to the surface of a canopy.

23 ***

1 **[A] CHANGE OF OCCUPANCY.** A change in the ~~((purpose or level of activity within a building~~
2 ~~that involves a change in application of the requirements of this code))~~ use of the building or a
3 portion of a building. A change of occupancy shall include any change of occupancy classification,
4 any change from one group to another group within an occupancy classification or any change in
5 use within a group for a specific occupancy classification.

6 **[W] CHILD CARE.** The care of children during any period of a 24-hour day.

7 **[W] CHILD CARE, FAMILY HOME.** A child care facility, licensed by the state of
8 Washington, located in the dwelling of the person or persons under whose direct care and
9 supervision the child is placed, for the care of 12 or fewer children, including children who
10 reside at the home.

11 ***

12 **[W] CLOSED CIRCUIT TELEPHONE.** A telephone with a dedicated line such as a house
13 phone, courtesy phone or phone that must be used to gain entrance to a facility.

14 ***

15 **[A] CONSTRUCTION DOCUMENTS.** Written, graphic and pictorial documents, in
16 electronic or paper format, prepared or assembled for describing the design, location and
17 physical characteristics of the elements of a project necessary for obtaining a building permit
18 and final approval of construction.

19 ***

20 **COVERED BOAT MOORAGE.** A pier or system of floating or fixed accessways to which
21 vessels on water may be secured, and any portion of which is covered by a roof.

22 ***

1 ~~((**[BS] DANGEROUS.** Any building, structure or portion thereof that meets any of the~~
2 ~~conditions described below shall be deemed dangerous:~~

3 ~~1. The building or structure has collapsed, has partially collapsed, has moved off its~~
4 ~~foundation or lacks the necessary support of the ground.~~

5 ~~2. There exists a significant risk of collapse, detachment or dislodgment of any portion,~~
6 ~~member, appurtenance or ornamentation of the building or structure under service~~
7 ~~loads.))~~

8 ***

9 **[A] DEFERRED SUBMITTAL.** Those portions of the design that are not submitted at the time
10 of the application and that are to be submitted to the building official within a specified period.

11 Deferred submittals include but are not limited to shop drawings for truss systems and sprinkler
12 systems.

13 ***

14 **DISPLAY SURFACE.** The area of a sign structure used to display the message.

15 ***

16 **[W] EFFICIENCY DWELLING UNIT.** A dwelling unit containing only one habitable room.

17 ***

18 **ELECTRIC SIGN.** Any sign containing electrical wiring, but not including signs illuminated by
19 an exterior light source.

20 ***

21 ~~((**[F] EMERGENCY POWER SYSTEM.** A source of automatic electric power of a required~~
22 ~~capacity and duration to operate required life safety, fire alarm, detection and ventilation~~
23 ~~systems in the event of a failure of the primary power. Emergency power systems are required~~

1 ~~for electrical loads where interruption of the primary power could result in loss of human life or~~
2 ~~serious injuries.))~~

3 **EMERGENCY POWER SYSTEM.** An electrical system that complies with Seattle Electrical
4 Code Article 700.

5 ***

6 **[BS] EXISTING BUILDING, EXISTING STRUCTURE (Except for Section 1612.2).** A
7 building or structure erected prior to the date of adoption of the appropriate code, or one for
8 which a valid Certificate of Occupancy (~~legal building permit~~) has been issued. For application
9 of provisions in flood hazard areas, an existing structure is any building or structure for which
10 the start of construction commenced before the effective date of the community's first flood plain
11 management code, ordinance or standard.

12 ***

13 **EXIT PASSAGEWAY.** An *exit* component that (~~is separated from other interior spaces of a~~
14 ~~building or structure by fire-resistance-rated construction and opening protectives, and~~) provides
15 for a protected path of egress travel in a horizontal direction to an *exit* or to the *exit discharge*.

16 ***

17 **FEE SUBTITLE.** Seattle Municipal Code Title 22, Subtitle IX.

18 ***

19 **FIRE CODE OFFICIAL.** The chief of the Seattle Fire Department or a duly authorized
20 representative.

21 ***

22 **FIRE DETECTION SYSTEM.** A system of smoke or heat detectors monitored at an approved
23 central station, with no requirement for notification appliances in the building.

FIRE DISTRICT. That part of the city within the boundary described as follows:

Beginning at the intersection of the center line of Alaskan Way and Clay Street; thence
northeasterly along the center line of Clay Street to an intersection with the center line of Denny
Way; thence easterly along the center line of Denny Way to an intersection with the center line of
Yale Avenue; thence southeasterly along the center line of Yale Avenue to an intersection with the
center line of Interstate Highway 5; thence southerly and southeasterly along the centerline of
Interstate Highway 5 to an intersection with the center line of 7th Avenue South; thence southerly
along the center line of 7th Avenue South to an intersection with the center line of Dearborn Street;
thence westerly along the center line of Dearborn Street to an intersection with the center line of
Airport Way; thence northwesterly along the center line of Airport Way to an intersection with the
center line of 4th Avenue South; thence southerly along the center line of 4th Avenue South to an
intersection with the center line of South Royal Brougham Way; thence westerly along the center
line of South Royal Brougham Way to an intersection with the center line of South Alaskan Way;
thence southerly along the center line of South Alaskan Way to an intersection with the center line
of South Massachusetts Street, thence westerly along the center line of South Massachusetts Street
to the Outer Harbor Line in Elliott Bay, thence northerly and northwesterly along the Outer Harbor
Line to an intersection with the center line of West Harrison Street, thence easterly along the center
line of West Harrison Street to an intersection with the center line of Alaskan Way, then
southeasterly along the center line of Alaskan Way to the point of beginning.

1 Buildings and structures located partially within and partially outside the Fire District are
2 considered to be located in the Fire District. See Figure 202F.

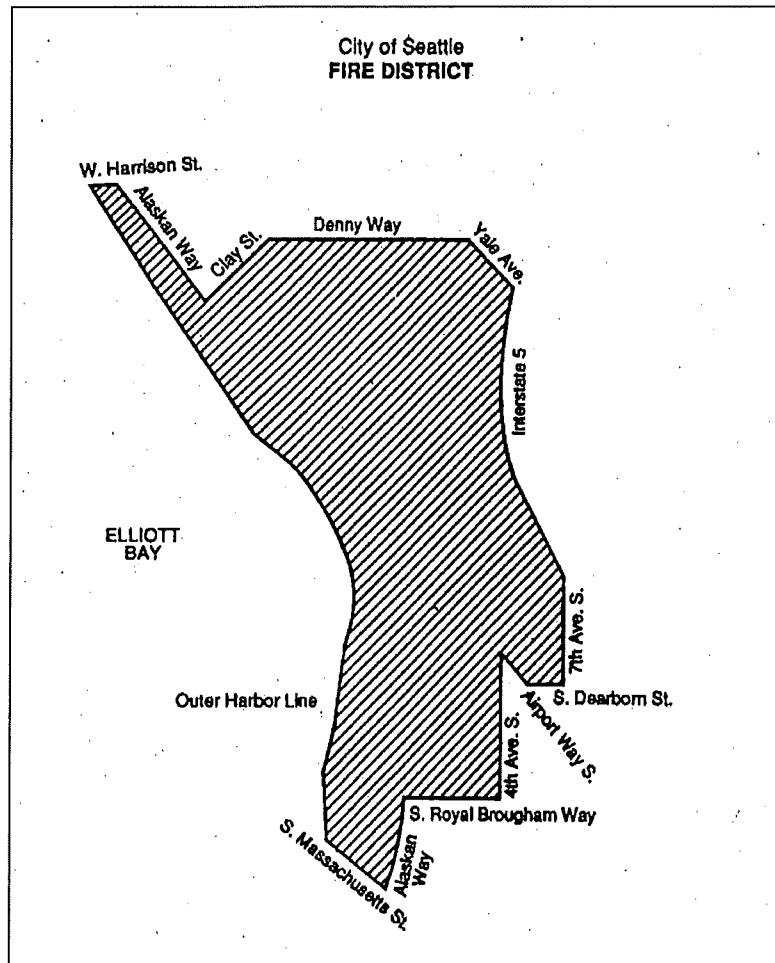

3 **Figure 202F**

4 ***

5 **FIRE-RETARDANT COVERING.** Material with a flame spread rating of less than 15 when
6 tested in accordance with ASTM E84.

7 ***

8 **FIRE SEPARATION DISTANCE.** The distance measured from the building face to one of the
9 following:

- 10 1. The closest interior lot line.

2. To the ~~((centerline))~~ opposite side of a street, an alley or *public way*.

3. To an imaginary line between two buildings on the lot.

The distance shall be measured at right angles from the face of the wall.

FIRE WALL. A fire-resistance-rated wall having protected openings, which restricts the spread of fire and extends continuously from the foundation to or through the roof ~~((, with sufficient structural stability under fire conditions to allow collapse of construction on either side without collapse of the wall))~~.

GRADE PLANE. A reference plane representing the average of finished ground level adjoining the building at *exterior walls*. Where the finished ground level slopes away from the *exterior walls*, the reference plane shall be established by the lowest points within the area between the building and the *lot line* or, where the *lot line* is more than 6 feet (1829 mm) from the building, between the building and a point 6 feet (1829 mm) from the building. For grade of structures built over water, see Section 425.3.

HEIGHT, BUILDING. The vertical distance from grade plane to the average height of the highest roof surface other than rooftop structures complying with Section 1510.

[A] HISTORIC BUILDINGS. ~~((Buildings that are listed in or eligible for listing in the National Register of Historic Places, or designated as historic under an appropriate state or local law.))~~
See "LANDMARK".

1 [W] HOSPICE CARE CENTER. A building or portion thereof used on a 24-hour basis for the
2 provision of hospice services to terminally ill inpatients.

3 ***

4 ~~(([A] JURISDICTION. The governmental unit that has adopted this code under due legislative~~
5 ~~authority.))~~

6 ***

7 LAND USE CODE. *Seattle Land Use Code*, Title 23 of the Seattle Municipal Code, as amended.

8 LAND-DISTURBING ACTIVITY. Any activity that results in a movement of earth, or a change
9 in the existing soil cover (both vegetative and nonvegetative) or the existing topography. Land-
10 disturbing activities include, but are not limited to, clearing, grading, filling, excavation or addition
11 or replacement of impervious surface.

12 LANDMARK. A building or structure that is subject to a requirement to obtain a certificate of
13 approval from the City Landmarks Preservation Board before altering or making significant
14 changes to specific features or characteristics, that has been nominated for designation and the City
15 Landmarks Preservation Board has not issued a determination regarding designation, that has been
16 designated for preservation by the City Landmarks Preservation Board, that has been designated
17 for preservation by the State of Washington, that has been listed or determined eligible to be listed
18 in the National Register of Historic Places, or that is located in a landmark or special review district
19 subject to a requirement to obtain a certificate of approval before making a change to the external
20 appearance of a structure.

21 ***

1 [W] MAILBOXES. Receptacles for the receipt of documents, packages or other deliverable
2 matter. Mailboxes include, but are not limited to, post office boxes and receptacles provided by
3 commercial mail-receiving agencies, apartment houses and schools.

4 ***

5 MARINA. A facility, generally on the waterfront, that stores and services boats in berths, on
6 moorings, and in dry storage or dry stack storage.

7 ***

8 MARQUEE. ((A canopy that has a top surface which is sloped less than 25 degrees from the
9 horizontal and is located less than 10 feet (3048 mm) from operable openings above or adjacent
10 to the level of the marquee.)) Marquees are a type of canopy. See “canopy”.

11 ***

12 NON-PRODUCTION LABORATORY FACILITY. A facility where the containers used for
13 reactions, transfers, and other handling of chemicals are designed to be easily and safely
14 manipulated by one person. It is a workplace where chemicals are used or synthesized on a
15 nonproduction basis.

16 ***

17 NONSTRUCTURAL TRIM. The moldings, battens, caps, nailing strips, laticing or cutouts
18 which are attached to the sign structure.

19 ***

20 [A] PERSON. An individual, ((heirs, executors, administrators or assigns, and also includes a))
21 receiver, administrator, executor, assignee, trustee in bankruptcy, trust estate, firm, partnership,
22 joint venture, club, company, joint stock company, business trust, municipal corporation,
23 political subdivision of the State of Washington, the State of Washington and any instrumentality

1 thereof, ((or)) corporation, limited liability company, association, society or any group of
2 individuals acting as a unit, whether mutual, cooperative, fraternal, nonprofit or otherwise, and
3 the United States or any instrumentality thereof. ((its or their successors or assigns, or the agent
4 of any of the aforesaid.))

5 ***

6 **PIER.** A structure, usually of greater length than width, of timber, stone, concrete or other
7 material, having a deck and projecting from the shore into waters so that boats may be moored
8 alongside for loading, unloading, storage, repairs or commercial uses.

9 ***

10 **[W] PORTABLE SCHOOL CLASSROOM.** A prefabricated structure consisting of one or
11 more rooms with direct exterior egress from the classroom(s). The structure is transportable in
12 one or more sections and is designed to be used as an educational space with or without a
13 permanent foundation. The structure shall be capable of being demounted and relocated to other
14 locations as needs arise.

15 ***

16 **PRIVATE TRANSFORMER VAULT.** A vault that contains transformer equipment that is not
17 owned by Seattle City Light or other electric power utility.

18 **PROJECTING SIGN.** A sign other than a wall sign, which projects from and is supported by a
19 wall of a building or structure.

20 ***

21 **REPAIR GARAGE.**

22 **Major repair garage.** A building or portions of a building where major repairs, such as engine
23 overhauls, painting, body and fender work, and repairs that require draining of the motor vehicle

1 fuel tank are performed on motor vehicles, including associated floor space used for offices,
2 parking, or showrooms.

3 **Minor repair garage.** A building or portions of a building used for lubrication, inspection, and
4 minor automotive maintenance work, such as engine tune-ups, replacement of parts, fluid
5 changes (e.g., oil, antifreeze, transmission fluid, brake fluid, air conditioning refrigerants, etc.),
6 brake system repairs, tire rotation, and similar routine maintenance work, including associated
7 floor space used for offices, parking, or showrooms.

8 ***

9 ~~((RETRACTABLE AWNING. A retractable awning is a cover with a frame that retracts against~~
10 ~~a building or other structure to which it is entirely supported.))~~

11 ***

12 **ROOF SIGN.** A sign erected upon or above a roof or parapet of a building or structure.

13 ***

14 **SECONDARY MEMBERS.** The following structural members shall be considered secondary
15 members and not part of the primary structural frame:

- 16 1. Structural members not having direct connections to the columns.
17 2. Members of the floor construction and roof construction not having direct connections to the
18 columns.
19 3. Bracing members other than those that are part of the primary structural frame.

20 **Interpretation I202S:** A *secondary member* (component or subsystem) is a structurally
21 significant portion of the building that is supported by the *primary structural frame*, but which
22 does not contribute to the strength or stability of the primary structure. *Secondary members* have
23 internal structural integrity to perform their function and have their interactions with and

1 attachments to, the *primary structural frame* analyzed and designed to assure proper integration
2 within the total structure.

3 ***

4 **SIGN STRUCTURE.** Any structure which supports or is designed to support any display
5 surface.

6 ***

7 **SLIP.** A berthing space between or adjacent to piers, wharves, or docks; the water areas
8 associated with boat moorage.

9 **[W] SMALL BUSINESS.** Any business entity (including a sole proprietorship, corporation,
10 partnership or other legal entity) which is owned and operated independently from all other
11 businesses, which has the purpose of making a profit, and which has 50 or fewer employees.

12 ***

13 ~~((**SMOKEPROOF ENCLOSURE.** An exit stairway or ramp designed and constructed so that~~
14 ~~the movement of the products of combustion produced by a fire occurring in any part of the~~
15 ~~building into the enclosure is limited.))~~

16 ***

17 **[W] STAGED EVACUATION.** A method of emergency response that engages building
18 components and trained staff to provide occupant safety during an emergency. Emergency
19 response involves moving or holding certain occupants at temporary locations for a brief period
20 of time before evacuating the building. This response is used by ambulatory surgery facility and
21 assisted living facilities to protect the health and safety of fragile occupants and residents.

22 ***

1 ~~((**[F] STANDBY POWER SYSTEM.** A source of automatic electric power of a required~~
2 ~~capacity and duration to operate required building, hazardous materials or ventilation systems in~~
3 ~~the event of a failure of the primary power. Standby power systems are required for electrical~~
4 ~~loads where interruption of the primary power could create hazards or hamper rescue or fire-~~
5 ~~fighting operations.))~~

6 **STANDBY POWER SYSTEM, LEGALLY REQUIRED.** An electrical power system that
7 complies with *Seattle Electrical Code* Article 701, Legally Required Standby Systems, and
8 Chapter 27.

9 ***

10 **STORY.** That portion of a building, including basements, located ~~((included))~~ between the
11 upper surface of a floor and the upper surface of the next floor or roof ~~((next))~~ above (see
12 “*Basement*,” “*Building height*,” “*Grade plane*” and “*Mezzanine*”). A story is measured as the
13 vertical distance from top to top of two successive tiers of beams or finished floor surfaces and,
14 for the topmost story, from the top of the floor finish to the top of the ceiling joists or, where
15 there is not a ceiling, to the top of the roof rafters.

16 **STORY ABOVE GRADE PLANE.** Any *story* having its finished floor surface entirely above
17 *grade plane*, or in which the finished surface of the next floor ~~((next))~~ above is:

- 18 1. More than 6 feet (1829 mm) above *grade plane*; or
- 19 2. More than 12 feet (3658 mm) above the finished ground level ~~((at any point))~~ for more
20 than 25 feet (7620 mm) of the perimeter. Required driveways up to 22 feet (6706 mm) wide shall
21 not be considered in calculating the 25 foot distance if there is at least 10 feet (3048 mm) between
22 the driveway and all portions of the 25 foot area. See Figure 202S.

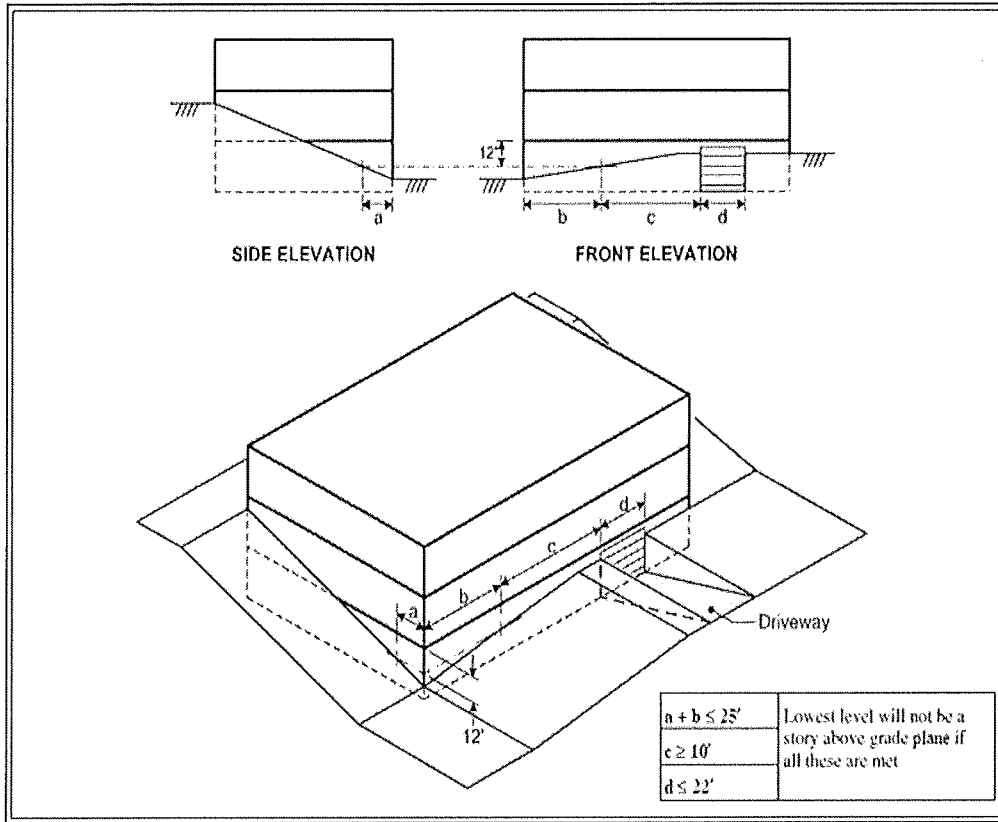

Figure 202S

Story Above Grade

STRUCTURAL ENGINEER IN RESPONSIBLE CHARGE. A structural engineer licensed to practice under the laws of the State of Washington who is engaged by the owner to review and coordinate structural design aspects of the project, as determined by the *building official*, for compatibility with the design of the building or structure, including submittal documents prepared by others, deferred submittal documents and phased submittal documents.

STRUCTURALLY QUALIFIED PRODUCTS. Products that have been prequalified based on current acceptance and certification by an accepted authority such as International Code Council (ICC), American Society for Testing and Materials (ASTM), American Concrete Institute (ACI),

1 American Institute of Steel Construction (AISC), or others widely accepted in the engineering
2 field.

3 ***

4 **[BS] SUBSTANTIAL IMPROVEMENT.** Any repair, reconstruction, rehabilitation, alteration,
5 addition or other improvement of a building or structure, the cost of which, in any five-year
6 period, equals or exceeds 50 percent of the market value of the structure before the
7 improvement or repair is started. If the structure has sustained substantial damage, any repairs
8 are considered substantial improvement regardless of the actual repair work performed. The
9 term does not, however, include either:

- 10 1. Any project for improvement of a building required to correct existing health, sanitary
11 or safety code violations identified by the *building official* and that are the minimum necessary
12 to assure safe living conditions.
- 13 2. Any alteration of a historic structure provided that the alteration will not preclude the
14 structure's continued designation as a historic structure.

15 ~~(([BS] SUBSTANTIAL STRUCTURAL DAMAGE. A condition where one or both of the~~
16 ~~following apply:~~

- 17 ~~1. The vertical elements of the lateral force-resisting system have suffered damage such~~
18 ~~that the lateral load-carrying capacity of any story in any horizontal direction has been~~
19 ~~reduced by more than 33 percent from its predamage condition.~~
- 20 ~~2. The capacity of any vertical component carrying gravity load, or any group of such~~
21 ~~components, that supports more than 30 percent of the total area of the structure's floors~~
22 ~~and roofs has been reduced more than 20 percent from its predamage condition and the~~
23 ~~remaining capacity of such affected elements, with respect to all dead and live loads, is~~

1 ~~less than 75 percent of that required by this code for new buildings of similar structure,~~
2 ~~purpose and location.))~~

3 **SUBSTRUCTURE.** The portion of the construction below and including the deck
4 immediately above the water.

5 ***

6 **SUPERSTRUCTURE.** The portion of construction above the deck.

7 **Exception:** Covered boat moorage.

8 ***

9 **[W] TRANSIENT LODGING.** A building, facility or portion thereof, excluding inpatient
10 medical care facilities and long-term care facilities, that contains one or more dwelling units or
11 sleeping units. Examples of transient lodging include, but are not limited to, resorts, group
12 homes, hotels, motels, dormitories, homeless shelters, halfway houses and social service lodging.

13 ***

14 **UNSAFE.** Structurally unsound, provided with inadequate egress, constituting a fire hazard, or
15 otherwise dangerous to human life, or constituting a hazard to safety, health or public welfare.

16 ***

17 **[F] USE (MATERIAL).** Placing a material into action, including *solids*, *liquids* and gases.

18 **Interpretation I202U: USE,** where otherwise mentioned in this code, is equivalent to character
19 of occupancy and not intended to be construed as the definition of “use” in the *Land Use Code*.

20 **UTILITY TRANSFORMER VAULT.** A vault containing transformer equipment owned by
21 Seattle City Light or other electric power utility.

22 ***

1 **WHARF.** A structure or bulkhead constructed of wood, stone, concrete or similar material built
2 at the shore of a harbor, lake or river for vessels to lie alongside of, and to anchor piers or floats.

3 ***

4 Section 4. The following sections of Chapter 3 of the International Building Code, 2015
5 Edition, are amended as follows:

6 **CHAPTER 3**

7 **USE AND OCCUPANCY CLASSIFICATION**

8 ***

9 **SECTION 304**

10 **BUSINESS GROUP B**

11 **304.1 Business Group B.** Business Group B occupancy includes, among others, the use of a
12 building or structure, or a portion thereof, for office, professional or service-type transactions,
13 including storage of records and accounts. Business occupancies shall include, but not be limited
14 to, the following:

15 Airport traffic control towers

16 *Ambulatory care facilities*

17 Animal hospitals, kennels and pounds

18 Banks

19 Barber and beauty shops

20 Car wash

21 Civic administration

22 *Clinic, outpatient*

23 Dry cleaning and laundries: pick-up and delivery stations and self-service

- 1 Educational occupancies for students above the 12th grade
- 2 Electronic data processing
- 3 Food processing establishments and commercial kitchens not associated with restaurants,
4 cafeterias and similar dining facilities, and not more than 2,500 square feet (232 m²) in
5 area.
- 6 Laboratories: testing and research
- 7 Motor vehicle showrooms
- 8 Post offices
- 9 Print shops
- 10 Professional services (architects, attorneys, dentists, physicians, engineers, etc.)
- 11 Radio and television stations
- 12 Telephone exchanges
- 13 Training and skill development not in a school or academic program (this shall include, but
14 not be limited to, tutoring centers, martial arts studios, gymnastics and similar uses
15 regardless of the ages served, and where not classified as a Group A occupancy).

16 ***

17 **SECTION 305**

18 **EDUCATIONAL GROUP E**

19 ***

20 **305.2 Group E, day care facilities.** This group includes buildings and structures or portions
21 thereof occupied by more than five children older than 2 1/2 years of age who receive
22 educational, supervision or *personal care services* for fewer than 24 hours per day.

1 **305.2.1 Within places of religious worship.** Rooms and spaces within *places of religious*
2 *worship* providing such day care during religious functions shall be classified as part of the
3 primary occupancy.

4 **305.2.2 Five or fewer children.** A facility having five or fewer children receiving such day
5 care shall be classified as part of the primary occupancy.

6 **305.2.3 Five or fewer children in a dwelling unit.** A facility such as the above within a
7 *dwelling unit* and having five or fewer children receiving such day care shall be classified as
8 a Group R-3 occupancy or shall comply with the *International Residential Code*.

9 **[W] 305.2.4 Family home child care.** Family home child care licensed by Washington State for
10 the care of twelve or fewer children shall be classified as Group R-3 or shall comply with the
11 *International Residential Code*.

SECTION 306

FACTORY GROUP F

15 **306.2 Moderate-hazard factory industrial, Group F-1.** Factory industrial uses that are not
16 classified as Factory Industrial F-2 Low Hazard shall be classified as F-1 Moderate Hazard and
17 shall include, but not be limited to, the following:

18 Aircraft (manufacturing, not to include repair)

19 Appliances

20 Athletic equipment

21 Automobiles and other motor vehicles

22 Bakeries

23 Beverages: over 16-percent alcohol content

- 1 Bicycles
- 2 Boats
- 3 Brooms or brushes
- 4 Business machines
- 5 Cameras and photo equipment
- 6 Canvas or similar fabric
- 7 Carpets and rugs (includes cleaning)
- 8 Clothing
- 9 Construction and agricultural machinery
- 10 Disinfectants
- 11 Dry cleaning and dyeing
- 12 Electric generation plants
- 13 Electronics
- 14 Engines (including rebuilding)
- 15 Food processing establishments and commercial kitchens not associated with restaurants,
16 cafeterias and similar dining facilities, and more than 2,500 square feet (232 m²) in area.
- 17 Furniture
- 18 Hemp products
- 19 Jute products
- 20 Laundries
- 21 Leather products
- 22 Machinery
- 23 Marijuana processing

- 1 Metals
- 2 Millwork (sash and door)
- 3 Motion pictures and television filming (without spectators)
- 4 Musical instruments
- 5 Optical goods
- 6 Paper mills or products
- 7 Photographic film
- 8 Plastic products
- 9 Printing or publishing
- 10 Recreational vehicles
- 11 Refuse incineration
- 12 Shoes
- 13 Soaps and detergents
- 14 Textiles
- 15 Tobacco
- 16 Trailers
- 17 Upholstering
- 18 Wood; distillation
- 19 Woodworking (cabinet)

SECTION 308

INSTITUTIONAL GROUP I

1 **308.2 Definitions.** The following terms are defined in Chapter 2:

2 **24-HOUR BASIS.**

3 **CUSTODIAL CARE.**

4 **DETOXIFICATION FACILITIES.**

5 **FOSTER CARE FACILITIES.**

6 **[W] HOSPICE CARE CENTER.**

7 **HOSPITALS AND PSYCHIATRIC HOSPITALS.**

8 **INCAPABLE OF SELF-PRESERVATION.**

9 **MEDICAL CARE.**

10 **NURSING HOMES.**

11 **308.3 Institutional Group I-1.** Institutional Group I-1 occupancy shall include buildings,
12 structures or portions thereof for more than 16 persons, excluding staff, who reside on a 24- hour
13 basis in a supervised environment and receive custodial care. Buildings of Group I-1 shall be
14 classified as one of the occupancy conditions specified in Section 308.3.1 or 308.3.2. This group
15 shall include, but not be limited to, the following:

16 Alcohol and drug centers

17 Assisted living facilities

18 Congregate care facilities

19 *Group homes*

20 Halfway houses

21 Residential board and care facilities

22 Social rehabilitation facilities

1 **308.3.1 Condition 1.** This occupancy condition shall include buildings in which all persons
2 receiving custodial care who, without any assistance, are capable of responding to an
3 emergency situation to complete building evacuation.

4 **308.3.2 Condition 2.** This occupancy condition shall include buildings in which there are
5 any persons receiving custodial care who require limited verbal or physical assistance while
6 responding to an emergency situation to complete building evacuation.

7 **[W] 308.3.3 Licensed care facilities.** Assisted living facilities licensed by Washington State
8 under Chapter 388-78A WAC and residential treatment facilities licensed by Washington
9 State under Chapter 246-337 WAC shall be classified as Group R-2.

10 ~~((**308.3.3 Six to sixteen persons receiving custodial care.** A facility housing not fewer than~~
11 ~~six and not more than 16 persons receiving custodial care shall be classified as Group R-4.))~~

12 **308.3.4 Five or fewer persons receiving custodial care.** A facility with five or fewer
13 persons receiving custodial care shall be classified as Group R-3 or shall comply with the
14 *International Residential Code* provided an *automatic sprinkler system* is installed in
15 accordance with Section 903.3.1.3 or Section P2904 of the *International Residential Code*.

16 **[W] 308.3.5 Adult family homes.** Adult family homes licensed by Washington state shall be
17 classified as Group R-3 or shall comply with the International Residential Code.

18 **308.4 Institutional Group I-2.** Institutional Group I-2 occupancy shall include buildings and
19 structures used for *medical care* on a 24-hour basis for more than five persons who are *incapable*
20 *of self-preservation*. This group shall include, but not be limited to, the following:

21 *Foster care facilities*

22 *Detoxification facilities*

23 *Hospice care centers*

1 *Hospitals*

2 *Nursing homes*

3 *Psychiatric hospitals*

4 **308.4.1 Occupancy conditions.** Buildings of Group I-2 shall be classified as one of the
5 occupancy conditions specified in Section 308.4.1.1 or 308.4.1.2.

6 **308.4.1.1 Condition 1.** This occupancy condition shall include facilities that provide
7 nursing and medical care but do not provide emergency care, surgery, obstetrics or in-
8 patient stabilization units for psychiatric or detoxification, including but not limited to
9 nursing homes and foster care facilities.

10 **308.4.1.2 Condition 2.** This occupancy condition shall include facilities that provide
11 nursing and medical care and could provide emergency care, surgery, obstetrics or in-
12 patient stabilization units for psychiatric or detoxification, including but not limited to
13 hospitals.

14 **308.4.2 Five or fewer persons receiving medical care.** A facility with five or fewer persons
15 receiving medical care shall be classified as Group R-3 or shall comply with the
16 *International Residential Code* provided an *automatic sprinkler system* is installed in
17 accordance with Section 903.3.1.3 or Section P2904 of the *International Residential Code*.

18 **[W] 308.4.3 Licensed care facilities.** Assisted living facilities licensed by Washington state
19 under chapter 388-78A WAC and residential treatment facilities licensed by Washington state
20 under chapter 246-337 WAC shall be classified as Group R-2.

21 ***

22 **308.6 Institutional Group I-4, day care facilities.** Institutional Group I-4 occupancy shall
23 include *buildings* and structures occupied by more than five persons of any age who receive

1 *custodial care* for fewer than 24 hours per day by persons other than parents or guardians,
2 relatives by blood, marriage or adoption, and in a place other than the home of the person cared
3 for. This group shall include, but not be limited to, the following:

4 Adult day care

5 Child day care

6 **308.6.1 Classification as Group E.** A child day care facility that provides care for more than
7 five but not more than 100 children 2 1/2 years or less of age, where the rooms in which the
8 children are cared for are located on a *level of exit discharge* serving such rooms and each of
9 these child care rooms has an *exit* door directly to the exterior, shall be classified as Group E.

10 **308.6.2 Within a place of religious worship.** Rooms and spaces within *places of religious*
11 *worship* providing such care during religious functions shall be classified as part of the
12 primary occupancy.

13 **308.6.3 Five or fewer persons receiving care.** A facility having five or fewer persons
14 receiving *custodial care* shall be classified as part of the primary occupancy.

15 **308.6.4 Five or fewer persons receiving care in a dwelling unit.** A facility such as the
16 above within a *dwelling unit* and having five or fewer persons receiving *custodial care* shall
17 be classified as a Group R-3 occupancy or shall comply with the *International Residential*
18 *Code*.

19 **[W] 308.6.5 Family home child care.** Family home child care licensed by Washington state
20 for the care of 12 or fewer children shall be classified as Group R-3 or shall comply with the
21 *International Residential Code*.

22 ***

23 **SECTION 310**

RESIDENTIAL GROUP R

[W] 310.2 Definitions. The following terms are defined in Chapter 2:

ADULT FAMILY HOME.

BOARDING HOUSE.

CHILD CARE.

CHILD CARE, FAMILY HOME.

CONGREGATE LIVING FACILITIES.

DORMITORY.

GROUP HOME.

GUEST ROOM.

LODGING HOUSE.

PERSONAL CARE SERVICE.

TRANSIENT.

[W] 310.4 Residential Group R-2. Residential Group R-2 occupancies containing *sleeping units* or more than two *dwelling units* where the occupants are primarily permanent in nature, including:

Apartment houses

Assisted living facilities licensed by Washington state under Chapter 388-78A WAC

Boarding houses (nontransient) with more than 16 occupants

Congregate living facilities (nontransient) with more than 16 occupants

Convents

- 1 *Dormitories*
- 2 Fraternities and sororities
- 3 Hotels (nontransient)
- 4 Buildings that contain three or more ((~~E~~))live/work units
- 5 Monasteries
- 6 Motels (nontransient)
- 7 Residential treatment facilities licensed by Washington state under Chapter 246-337 WAC
- 8 Vacation timeshare properties

9 **310.5 Residential Group R-3.** Residential Group R-3 occupancies where the occupants are
10 primarily permanent in nature and not classified as Group R-1, R-2, ((~~R-4~~)) or I, including:

- 11 Buildings that do not contain more than two *dwelling units*
- 12 *Boarding houses* (nontransient) with 16 or fewer occupants
- 13 *Boarding houses (transient)* with 10 or fewer occupants
- 14 Care facilities that provide accommodations for five or fewer persons receiving care
- 15 *Congregate living facilities* (nontransient) with 16 or fewer occupants
- 16 *Congregate living facilities (transient)* with 10 or fewer occupants
- 17 Buildings that do not contain more than two live/work units
- 18 *Lodging houses* with five or fewer *guest rooms*

19 **310.5.1 Care facilities within a dwelling.** Care facilities for five or fewer persons receiving
20 care that are within a single-family dwelling are permitted to comply with the *International*
21 *Residential Code* provided an *automatic sprinkler system* is installed in accordance with
22 Section 903.3.1.3 or Section P2904 of the *International Residential Code*.

1 **310.5.2 Lodging houses.** Owner-occupied *lodging houses* with five or fewer *guest rooms*
2 shall be permitted to be constructed in accordance with the *International Residential Code*.

3 **[W] 310.5.3 Adult family homes, family home child care.** Adult family homes and family
4 home child care facilities that are within a single-family home are permitted to comply with
5 the *International Residential Code*.

6 **[W] 310.5.4 Foster family care homes.** Foster family care homes licensed by Washington
7 state are permitted to comply with the *International Residential Code*, as an accessory use to
8 a dwelling, for six or fewer children including those of the resident family.

9 ~~((**310.6 Residential Group R-4.** Residential Group R-4 occupancy shall include buildings,~~
10 ~~structures or portions thereof for more than five but not more than 16 persons, excluding staff,~~
11 ~~who reside on a 24-hour basis in a supervised residential environment and receive *custodial care*.~~
12 Buildings of Group R-4 shall be classified as one of the occupancy conditions specified in
13 Section 310.6.1 or 310.6.2. This group shall include, but not be limited to, the following:

14 Alcohol and drug centers

15 Assisted living facilities

16 Congregate care facilities

17 *Group homes*

18 Halfway houses

19 Residential board and care facilities

20 Social rehabilitation facilities

21 Group R-4 occupancies shall meet the requirements for construction as defined for Group R-
22 3, except as otherwise provided for in this code.

1 ~~**310.6.1 Condition 1.** This occupancy condition shall include buildings in which all persons~~
2 ~~receiving custodial care, without any assistance, are capable of responding to an emergency~~
3 ~~situation to complete building evacuation.~~

4 ~~**310.6.2 Condition 2.** This occupancy condition shall include buildings in which there are~~
5 ~~any persons receiving custodial care who require limited verbal or physical assistance while~~
6 ~~responding to an emergency situation to complete building evacuation.))~~

7 SECTION 311

8 STORAGE GROUP S

9 ***

10 **311.2 Moderate-hazard storage, Group S-1.** Storage Group S-1 occupancies are *buildings*
11 occupied for storage uses that are not classified as Group S-2, including, but not limited to,
12 storage of the following:

13 Aerosols, Levels 2 and 3

14 Aircraft hangar (storage and repair)

15 Bags: cloth, burlap and paper

16 Bamboos and rattan

17 Baskets

18 Belting: canvas and leather

19 Books and paper in rolls or packs

20 Boots and shoes

21 Buttons, including cloth covered, pearl or bone

22 Cardboard and cardboard boxes

23 Clothing, woolen wearing apparel

- 1 Cordage
- 2 Dry boat storage (indoor)
- 3 Furniture
- 4 Furs
- 5 Glues, mucilage, pastes and size
- 6 Grains
- 7 Horns and combs, other than celluloid
- 8 Leather
- 9 Linoleum
- 10 Lumber
- 11 Motor vehicle and marine repair garages complying with the maximum allowable quantities
12 of hazardous materials listed in Table 307.1(1) (see Section 406.8)
- 13 Photo engravings
- 14 Resilient flooring
- 15 Silks
- 16 Soaps
- 17 Sugar
- 18 Tires, bulk storage of
- 19 Tobacco, cigars, cigarettes and snuff
- 20 Upholstery and mattresses
- 21 Wax candles
- 22 **311.3 Low-hazard storage, Group S-2.** Storage Group S-2 occupancies include, among others,
23 *buildings* used for the storage of noncombustible materials such as products on wood pallets or

1 in paper cartons with or without single thickness divisions; or in paper wrappings. Such products
2 are permitted to have a negligible amount of plastic *trim*, such as knobs, handles or film
3 wrapping. Group S-2 storage uses shall include, but not be limited to, storage of the following:

4 Asbestos

5 Beverages up to and including 16-percent alcohol in metal, glass or ceramic containers

6 Cement in bags

7 Chalk and crayons

8 Covered boat moorage not classified as Group U

9 Dairy products in nonwaxed coated paper containers

10 Dry cell batteries

11 Electrical coils

12 Electrical motors

13 Empty cans

14 Food products

15 Foods in noncombustible containers

16 Fresh fruits and vegetables in nonplastic trays or containers

17 Frozen foods

18 Glass

19 Glass bottles, empty or filled with noncombustible liquids

20 Gypsum board

21 Inert pigments

22 Ivory

23 Meats

- 1 Metal cabinets
- 2 Metal desks with plastic tops and *trim*
- 3 Metal parts
- 4 Metals
- 5 Mirrors
- 6 Oil-filled and other types of distribution transformers
- 7 Parking garages, open or enclosed
- 8 Porcelain and pottery
- 9 Stoves
- 10 Talc and soapstones
- 11 Washers and dryers

SECTION 312

UTILITY AND MISCELLANEOUS GROUP U

14 **312.1 General.** *Buildings* and structures of an accessory character and miscellaneous structures
15 not classified in any specific occupancy shall be constructed, equipped and maintained to
16 conform to the requirements of this code commensurate with the fire and life hazard incidental to
17 their occupancy. Group U shall include, but not be limited to, the following:

- 18 Agricultural buildings
- 19 Aircraft hangars, accessory to a one- or two-family residence (see Section 412.5)
- 20 Barns
- 21 Carports
- 22 Covered boat moorage accessory to Group R-3 dwelling unit
- 23 Fences more than 6 feet (1829 mm) in height

- 1 Grain silos, accessory to a residential occupancy
- 2 Greenhouses and other structures used for cultivation, protection or maintenance of plants
- 3 Livestock shelters
- 4 Private garages that comply with Section 406.3
- 5 Retaining walls
- 6 Sheds
- 7 Stables
- 8 Tanks
- 9 Towers

10 Section 5. The following sections of Chapter 4 of the International Building Code, 2015
11 Edition, are amended as follows:

12 **CHAPTER 4**

13 **SPECIAL DETAILED REQUIREMENTS BASED ON USE AND OCCUPANCY**

14 ***

15 **SECTION 402**

16 **COVERED MALL AND OPEN MALL BUILDINGS**

17 ***

18 ~~((402.3 Lease plan. Each owner of a covered mall building or of an open mall building shall
19 provide both the building and fire departments with a lease plan showing the location of each
20 occupancy and its exits after the certificate of occupancy has been issued. No modifications or
21 changes in occupancy or use shall be made from that shown on the lease plan without prior
22 approval of the building official.))~~

23 ***

1 [F] **402.7.3 Emergency power system.** *Covered mall buildings* greater than 50,000 square
2 feet (4645 m²) in area and *open mall buildings* greater than 50,000 square feet (4645 m²)
3 within the established perimeter line shall be provided with emergency power systems that is
4 capable of operating the *emergency voice/alarm communication system* in accordance with
5 Section 2702.

6 ***

7 SECTION 403

8 HIGH-RISE BUILDINGS

9 **403.1 Applicability.** *High-rise buildings* shall comply with Sections 403.2 through 403.8
10 ((403.6)).

11 **Exception:** The provisions of Sections 403.2 through 403.6 shall not apply to the following
12 buildings and structures:

- 13 1. Airport traffic control towers in accordance with Section 412.3.
- 14 2. *Open parking garages* in accordance with Section 406.5.
- 15 3. The portion of a building containing a Group A-5 occupancy in accordance with Section
16 303.6.
- 17 4. Special industrial occupancies in accordance with Section 503.1.1.

18 ((~~5. Buildings with:~~

19 5.1. A Group H-1 occupancy;

20 5.2. A Group H-2 occupancy in accordance with Section 415.8, 415.9.2, 415.9.3 or 426.1;

21 or;

22 5.3. A Group H-3 occupancy in accordance with Section 415.8.))

23 **Interpretation I403.1a:** Item 2 only includes buildings in which parking is the principal use.

1 **Interpretation I403.1b:** For the purpose of this section, occupied roof decks are considered
2 floors used for human occupancy if the occupant load of the deck is ten or more on the roof of
3 a building not equipped with an automatic sprinkler system or where the occupant load is 50 or
4 more on the roof of a building that is equipped with an automatic sprinkler system.

5 **403.1.1 Presubmittal conference.** At least 60 days prior to application, the applicant shall
6 arrange a presubmittal conference with the design team, the building official and the fire code
7 official. The purpose of the meeting is to obtain conceptual approval from the building
8 official and the fire code official. The documentation of the presubmittal meeting shall be
9 reflected on the plans for the building and become a permanent part of the Department of
10 Construction and Inspection's records.

11 **Note:** High rise projects using an alternative lateral force resisting system are subject to peer
12 review which requires lengthy lead time. Applicants should contact the building official prior
13 to start of structural design. See Section 1613.

14 **403.1.2 Testing.** All mechanical and electrical equipment installed according to approved
15 plans and specifications pursuant to this section shall be tested and proven to be in proper
16 working condition to the satisfaction of the fire code official before issuance of the
17 Certificate of Occupancy. Such systems shall be maintained in accordance with the
18 *International Fire Code.*

19 **403.2 Construction.** The construction of *high-rise buildings* shall comply with the provisions of
20 Sections 403.2.1 through 403.2.4.

21 **403.2.1 Reduction in fire-resistance rating.** The *fire-resistance-rating* reductions listed in
22 Sections 403.2.1.1 and 403.2.1.2 shall be allowed in buildings that have sprinkler control

1 valves equipped with supervisory initiating devices and water-flow initiating devices for each
2 floor.

3 **403.2.1.1 Type of construction.** The following reductions in the minimum *fire-resistance*
4 *rating* of the building elements in Table 601 shall be permitted as follows:

- 5 1. For buildings not greater than 420 feet (128 000 mm) in *building height*, the *fire-*
6 *resistance rating* of the building elements in Type IA construction shall be
7 permitted to be reduced to the minimum *fire-resistance ratings* for the building
8 elements in Type IB.

9 **Exception:** The required *fire-resistance rating* of (~~columns supporting floors~~)
10 structural frame and bearing walls shall not be reduced.

- 11 2. In other than Group F-1, M and S-1 occupancies, the *fire-resistance rating* of the
12 building elements in Type IB construction other than structural frame and bearing
13 walls shall be permitted to be reduced to the fire-resistance ratings in Type IIA.

- 14 3. The building height and building area limitations of a building containing building
15 elements with reduced fire-resistance ratings shall be permitted to be the same as
16 the building without such reductions.

17 **403.2.1.2 Shaft enclosures.** For buildings not greater than 420 feet (128 000 mm) in
18 *building height*, the required *fire-resistance rating* of the *fire barriers* enclosing vertical
19 *shafts*, other than *interior exit stairway* and elevator hoistway enclosures, is permitted to
20 be reduced to 1 hour where automatic sprinklers are installed within the *shafts* at the top
21 and at alternate floor levels.

22 **403.2.2 Seismic considerations.** For seismic considerations, see Chapter 16.

1 **403.2.3 Structural integrity of interior exit stairways and elevator hoistway enclosures.**

2 For *high-rise buildings* of *Risk Category* III or IV in accordance with Section 1604.5, for fire
3 service access elevators, and for all buildings that are more than 420 feet (128 000 mm) in
4 *building height*, enclosures for *interior exit stairways* and elevator hoistway enclosures shall
5 comply with Sections 403.2.3.1 through 403.2.3.4.

6 **403.2.3.1 Wall assembly.** The wall assemblies making up the enclosures for *interior exit*
7 *stairways* and elevator hoistway enclosures shall meet or exceed Soft Body Impact
8 Classification Level 2 as measured by the test method described in ASTM C 1629/C
9 1629M.

10 **403.2.3.2 Wall assembly materials.** The face of the wall assemblies making up the
11 enclosures for *interior exit stairways* and elevator hoistway enclosures that are not
12 exposed to the interior of the enclosures for *interior exit stairways* or elevator hoistway
13 enclosure shall be constructed in accordance with one of the following methods:

- 14 1. The wall assembly shall incorporate no fewer than two layers of impact-resistant
15 construction board each of which meets or exceeds Hard Body Impact
16 Classification Level 2 as measured by the test method described in ASTM C
17 1629/C 1629M.
- 18 2. The wall assembly shall incorporate no fewer than one layer of impact-resistant
19 construction material that meets or exceeds Hard Body Impact Classification Level
20 3 as measured by the test method described in ASTM C 1629/C 1629M.
- 21 3. The wall assembly incorporates multiple layers of any material, tested in tandem,
22 that meets or exceeds Hard Body Impact Classification Level 3 as measured by the
23 test method described in ASTM C 1629/C 1629M.

1 **403.2.3.3 Concrete and masonry walls.** Concrete or masonry walls shall be deemed to
2 satisfy the requirements of Sections 403.2.3.1 and 403.2.3.2.

3 **403.2.3.4 Other wall assemblies.** Any other wall assembly that provides impact
4 resistance equivalent to that required by Sections 403.2.3.1 and 403.2.3.2 for Hard Body
5 Impact Classification Level 3, as measured by the test method described in ASTM C
6 1629/C 1629M, shall be permitted.

7 **403.2.4 Sprayed fire-resistant materials (SFRM).** The bond strength of the SFRM installed
8 throughout the building shall be in accordance with Table 403.2.4.

| TABLE 403.2.4 MINIMUM BOND STRENGTH | |
|---|-----------------------------------|
| HEIGHT OF BUILDING^a | SFRM MINIMUM BOND STRENGTH |
| Up to 420 feet | 430 psf |
| Greater than 420 feet | 1,000 psf |
| For SI: 1 foot = 304.8 mm, 1 pound per square foot (psf) = 0.0479 kW/m ² . a. Above the lowest level of fire department vehicle access. | |

9 **[F] 403.3 Automatic sprinkler system.** Buildings and structures shall be equipped throughout
10 with an *automatic sprinkler system* in accordance with Section 903.3.1.1 and a secondary water
11 supply where required by Section 403.3.3. See Section 903.3.1.1.3 for additional requirements
12 for sprinkler systems in high-rise buildings.

13 **Exception:** An *automatic sprinkler system* shall not be required in spaces or areas of((:

- 14 ~~1. Open parking garages in accordance with Section 406.5.~~
15 ~~2. Telecommunications)) telecommunications equipment buildings used exclusively for~~
16 telecommunications equipment, associated electrical power distribution equipment,
17 batteries and standby engines, provided that those spaces or areas are equipped
18 throughout with an automatic fire detection system in accordance with Section 907.2
19 and are separated from the remainder of the building by not less than 1-hour *fire*

1 *barriers* constructed in accordance with Section 707 or not less than 2-hour *horizontal*
2 *assemblies* constructed in accordance with Section 711, or both.

3 **[F] 403.3.1 Number of sprinkler risers and system design.** Each sprinkler system zone in
4 buildings that are more than 420 feet (128 000 mm) in *building height* shall be supplied by
5 no fewer than two risers. Each riser shall supply sprinklers on alternate floors. If more than
6 two risers are provided for a zone, sprinklers on adjacent floors shall not be supplied from the
7 same riser.

8 **[F] 403.3.1.1 Riser location.** Sprinkler risers shall be placed in *interior exit stairways*
9 and ramps that are remotely located in accordance with Section 1007.1.

10 ~~((**[F] 403.3.2 Water supply to required fire pumps.** In buildings that are more than 420 feet~~
11 ~~(128 000 mm) in *building height*, required fire pumps shall be supplied by connections to no~~
12 ~~fewer than two water mains located in different streets. Separate supply piping shall be~~
13 ~~provided between each connection to the water main and the pumps. Each connection and the~~
14 ~~supply piping between the connection and the pumps shall be sized to supply the flow and~~
15 ~~pressure required for the pumps to operate.~~

16 ~~**Exception:** Two connections to the same main shall be permitted provided the main is~~
17 ~~valved such that an interruption can be isolated so that the water supply will continue~~
18 ~~without interruption through no fewer than one of the connections.))~~

19 **[F]403.3.3 Secondary water supply.** An automatic secondary on-site water supply having a
20 capacity not less than the hydraulically calculated sprinkler demand, including the hose
21 stream requirement, shall be provided for *high-rise buildings* assigned to Seismic Design
22 Category C, D, E or F as determined by Section 1613. An additional fire pump shall not be
23 required for the secondary water supply unless needed to provide the minimum design intake

1 pressure at the suction side of the fire pump supplying the *automatic sprinkler system*. The
2 secondary water supply shall have a duration of not less than 30 minutes.

3 **[F] 403.3.4 Fire pump room.** Fire pumps shall be located in rooms protected in accordance
4 with Section 913.2.1.

5 **[F] 403.4 Emergency systems.** The detection, alarm and emergency systems of *high-rise*
6 *buildings* shall comply with Sections 403.4.1 through 403.4.8.

7 **[F] 403.4.1 Smoke detection.** Smoke detection shall be provided in accordance with Section
8 907.2.13.1.

9 **[F] 403.4.2 Fire alarm system.** A *fire alarm* system shall be provided in accordance with
10 Section 907.2.13.

11 **[F] 403.4.3 Standpipe system.** A *high-rise building* shall be equipped with a standpipe
12 system as required by Section 905.3.

13 **[F] 403.4.4 Emergency voice/alarm communication system.** An *emergency voice/alarm*
14 *communication system* shall be provided in accordance with Section 907.5.2.2.

15 **[F] 403.4.5 Emergency responder radio coverage.** Emergency responder radio coverage
16 shall be provided in accordance with Section 510 of the *International Fire Code*.

17 **[F] 403.4.6 Fire command.** A *fire command center* complying with Section 911 shall be
18 provided in a location *approved* by the fire department.

19 **403.4.7 No requirements.** ~~((Smoke removal. To facilitate smoke removal in post-fire~~
20 ~~salvage and overhaul operations, buildings and structures shall be equipped with natural or~~
21 ~~mechanical *ventilation* for removal of products of combustion in accordance with one of the~~
22 ~~following:~~

1 ~~1. Easily identifiable, manually operable windows or panels shall be distributed around~~
2 ~~the perimeter of each floor at not more than 50-foot (15 240 mm) intervals. The area of~~
3 ~~operable windows or panels shall be not less than 40 square feet (3.7 m²) per 50 linear~~
4 ~~feet (15 240 mm) of perimeter.~~

5 **Exceptions:**

6 1. ~~In Group R-1 occupancies, each *sleeping unit* or suite having an *exterior wall*~~
7 ~~shall be permitted to be provided with 2 square feet (0.19 m²) of venting area in~~
8 ~~lieu of the area specified in Item 1.~~

9 2. ~~Windows shall be permitted to be fixed provided that glazing can be cleared by~~
10 ~~fire fighters.~~

11 2. ~~Mechanical air handling equipment providing one exhaust air change every 15 minutes~~
12 ~~for the area involved. Return and exhaust air shall be moved directly to the outside~~
13 ~~without recirculation to other portions of the building.~~

14 3. ~~Any other approved design that will produce equivalent results.))~~

15 **[F] 403.4.8 ((Standby and e))Emergency power.** ~~((A standby power system complying with~~
16 ~~Section 2702 and Section 3003 shall be provided for the standby power loads specified in~~
17 ~~Section 403.4.8.3.)) An emergency power system complying with Section 2702 shall be~~
18 ~~provided for the emergency power loads specified in Section 403.4.8.4.~~

19 **[F] 403.4.8.1 Equipment room.** ~~If the ((standby or)) emergency power system includes a~~
20 ~~generator set inside a building, the system shall be located in a separate room enclosed~~
21 ~~with 2-hour *fire barriers* constructed in accordance with Section 707 or *horizontal*~~
22 ~~*assemblies* constructed in accordance with Section 711, or both. System supervision with~~
23 ~~manual start and transfer features shall be provided at the *fire command center*.~~

1 **Exceptions:**

- 2 1. In Group I-2, Condition 2, manual start and transfer features for the critical
3 branch of the emergency power are not required to be provided at the *fire*
4 *command center*.
- 5 2. Where located within a sprinklered parking garage of Type I or II construction,
6 emergency power and legally required standby power systems with fixed fuel
7 quantities meeting the limits of Section 603.3 of the *International Fire Code*, and
8 their transfer switches, are not required to be in a separate room. Other
9 occupancies located in the story where the system is located shall be separated
10 from the system by fire barriers with a minimum 1 hour fire-resistance rating.
- 11 3. Combustion and radiator intake air are permitted to be transferred from the
12 adjacent garage. Radiator discharge air is permitted to be transferred to the
13 adjacent garage. Radiator ventilation intake and discharge air locations shall be
14 separated to maintain the radiator ventilation intake air temperature below the
15 maximum temperature allowed to meet the emergency and legally required
16 standby power system loads.

17 **[F] 403.4.8.2 Fuel line piping protection.** Fuel lines supplying a generator set inside a
18 building shall be separated from areas of the building other than the room the generator is
19 located in by an approved method or assembly that has a fire-resistance rating of not less
20 than 1 hour. ~~((2 hours where the building is protected throughout with an automatic~~
21 ~~sprinkler system installed in accordance with Section 903.3.1.1 or 903.3.1.2, the required~~
22 ~~fire-resistance rating shall be reduced to 1 hour.))~~

1 ~~((**[F] 403.4.8.3 Standby power loads.** The following are classified as standby power~~
2 ~~loads:~~

3 ~~1. Power and lighting for the *fire command center* required by Section 403.4.6.~~

4 ~~2. *Ventilation* and automatic fire detection equipment for *smokeproof enclosures*.~~

5 ~~3. Elevators.~~

6 ~~4. Where elevators are provided in a *high-rise building* for *accessible means of*~~

7 ~~*egress*, fire service access or occupant self-evacuation, the standby power system~~

8 ~~shall also comply with Sections 1009.4, 3007 or 3008, as applicable.))~~

9 **[F] 403.4.8.4 Emergency power loads.** The following are classified as emergency power
10 loads:

11 1. Exit signs and *means of egress* illumination required by Chapter 10.

12 2. Elevator car lighting.

13 3. Emergency voice/alarm communications systems.

14 4. Automatic fire detection systems.

15 5. Fire alarm systems.

16 6. Electrically powered fire pumps.

17 7. Power and lighting for mechanical equipment rooms and the fire command center

18 required by Section 403.4.6.

19 8. Lighting for elevator cars, machine rooms, machine spaces and control rooms.

20 9. Ventilation and cooling equipment for elevator machine rooms, machine spaces

21 and control rooms.

22 10. Ventilation and automatic fire detection equipment for pressurized stairways and

23 elevator hoistways.

1 11. Smoke control system.

2 12. A selected elevator in each elevator group, in accordance with Section 3016.6. All
3 elevators shall be transferable to an emergency power system.

4 **Note:** No more than four cars are permitted within a hoistway. See Section 3016.7.

5 13. For fire service access and occupant evacuation elevators:

6 13.1 Operation of all fire service access elevator cars.

7 13.2 Operation of all occupant evacuation elevators until they are recalled.

8 13.3. Elevator controller cooling equipment.

9 13.4. For fire service access elevators only, elevator hoistway lighting.

10 14. Emergency responder radio coverage.

11 **403.5 Means of egress and evacuation.** *The means of egress in high-rise buildings shall comply*
12 *with Sections 403.5.1 through 403.5.6.*

13 **403.5.1 Remoteness of interior exit stairways.** *Required interior exit stairways shall be*
14 *separated by a distance not less than 30 feet (9144 mm) or not less than one-fourth of the*
15 *length of the maximum overall diagonal dimension of the building or area to be served,*
16 *whichever is less. The distance shall be measured in a straight line between the nearest points*
17 *of the enclosure surrounding the interior exit stairways. In buildings with three or more*
18 *interior exit stairways, no fewer than two of the interior exit stairways shall comply with this*
19 *section. Interlocking or scissor stairways shall be counted as one interior exit stairway.*

20 **Exception:** In buildings containing primarily Group R occupancies, required interior exit
21 stairways are permitted to be separated by a distance not less than 15 feet (4572 mm).

22 **403.5.2 Additional interior exit stairway.** *For buildings other than Group R-2 that are more*
23 *than 420 feet (128 000 mm) in building height, one additional interior exit stairway meeting*

1 the requirements of Sections 1011 and 1023 shall be provided in addition to the minimum
2 number of *exits* required by Section 1006.3. The stairway need only serve floors above the
3 lowest level of exit discharge. The total width of any combination of remaining *interior exit*
4 *stairways* with one *interior exit stairway* removed shall be not less than the total width
5 required by Section 1005.1. *Scissor stairways* shall not be considered the additional *interior*
6 *exit stairway* required by this section.

7 **Interpretation I403.5.2** An additional interior exit stairway is not required when the building
8 above the 420 foot level contains only Group R-2 occupancy. If the building above the 420
9 foot level contains a Group R-2 and another occupancy, or if the building does not contain a
10 Group R-2 above the 420 foot level, then an additional interior exit stairway is required.

11 **Exception:** ~~((An))~~ Subject to the approval of the building official, an additional *interior*
12 *exit stairway* shall not be required to be installed in buildings having elevators used for
13 occupant self-evacuation in accordance with Section ~~((3008))~~ 403.6.2.

14 **403.5.3 Stairway door operation.** *Stairway* doors other than the *exit discharge* doors shall
15 be permitted to be locked from the *stairway* side. *Stairway* doors that are locked from the
16 *stairway* side shall be capable of being unlocked simultaneously without unlatching upon a
17 signal from the *fire command center* and shall be capable of being unlocked simultaneously
18 and automatically upon a signal from a fire alarm originating anywhere in the building.
19 When stairway doors are installed that are not locked from the stairway side, wiring shall be
20 installed to facilitate future installations of locking hardware.

21 **403.5.3.1 Stairway communication system.** A telephone or other two-way
22 communications system connected to an *approved constantly attended station* shall be

1 provided at not less than every fifth floor in each *stairway* (~~where the doors to the~~
2 ~~*stairway* are locked~~)).

3 **403.5.4 ((Smokeproof enclosures.)) Smoke control in exit stairways.** Every required
4 *interior exit stairway* serving floors more than 75 feet (22 860 mm) above the lowest level of
5 fire department vehicle access shall (~~be a *smokeproof enclosure* in accordance~~) comply with
6 Sections 909.20 and 1023.11.

7 **Exception:** Unless required by other sections of this code, portions of such stairways
8 which serve floors below the level of exit discharge are not required to comply with
9 Sections 909.20 and 1023.11 if the portion of the stairway below the level of exit
10 discharge is separated from the pressurized stairway with not less than 1 hour fire barriers
11 or horizontal assemblies or both.

12 ***

13 **403.5.7 Access to roofs.** Access to all roof levels with a slope less than 4:12 shall be
14 provided by stairways.

15 **Exception:** Access to unoccupied roofs is permitted to be provided by ship's ladders or
16 alternating tread devices.

17 **403.5.8 Termination of required stairways.** All required interior exit stairways shall
18 terminate at the roof level with an exterior door complying with Sections 1010.1.1 and
19 1010.1.2.

20 **403.6 Elevators.** Elevator installation and operation in *high-rise buildings* shall comply with
21 Chapter 30 and this section. (~~Sections 403.6.1 and 403.6.2.~~)

22 **403.6.1 Fire service access elevator.** In buildings with an occupied floor more than 120 feet
23 (36 576 mm) above the lowest level of fire department vehicle access, every floor of the

1 building shall be served by no fewer than two fire service access elevators~~((, or all elevators,~~
2 ~~whichever is less, shall be provided))~~ in accordance with this section ~~((Section 3007))~~. Each
3 fire service access elevator shall have a capacity of not less than 3,500 pounds (1588 kg) and
4 shall comply with Section ~~((3002.4))~~ 3016.12.

5 **Exceptions:**

- 6 1. Buildings with one elevator shall be provided with one fire service access
7 elevator.
- 8 2. Floors below the lowest street-level building entrance are not required to be
9 served by fire service access elevators.
- 10 3. Elevators serving only floors less than 75 feet above the lowest street-level
11 building entrance are not required to be fire service access elevators.

12 **403.6.1.1 Machine rooms.** Each fire service access elevator shall be served by a
13 different machine or control room.

14 **403.6.1.2 Water protection.** An approved method to prevent water from infiltrating into
15 the hoistway enclosure from the operation of the automatic sprinkler system outside the
16 fire service access elevator lobby shall be provided.

17 **403.6.1.3 Hoistway enclosures.** The fire service access elevator hoistway shall be
18 located in a shaft enclosure complying with Section 713.

19 **403.6.1.4 Hoistway lighting.** When fire-fighters' emergency operation is active, the
20 entire height of the hoistway shall be illuminated at not less than 1 footcandle (11 lux) as
21 measured from the top of the car of each fire service access elevator.

22 **403.6.1.5 Fire service access elevator lobby.** The fire service access elevator shall open
23 into a fire service access elevator lobby in accordance with Sections 403.6.1.5 through

1 403.6.1.5.5. Egress is permitted through the elevator lobby in accordance with Item 1 of
2 Section 1016.2.

3 **Exception:** Where a fire service access elevator has two entrances onto a floor, the
4 second entrance shall be permitted to open into an elevator lobby in accordance with
5 Section 713.14.1.

6 **403.6.1.5.1 Access to interior exit stairway or ramp.** The fire service access
7 elevator lobby shall have *direct access* from the enclosed elevator lobby to an
8 enclosure for an interior exit stairway or ramp.

9 **Exception:** Access to an *interior exit stairway or ramp* shall be permitted to be
10 through a protected path of travel that has a level of fire protection not less than
11 the elevator lobby enclosure. The protected path shall be separated from the
12 enclosed elevator lobby through an opening protected by a smoke and draft
13 control assembly in accordance with Section 716.5.3.

14 **403.6.1.5.2 Lobby enclosure.** The fire service access elevator lobby shall be enclosed
15 with a smoke barrier having a fire-resistance rating of not less than 1 hour, except that
16 lobby doorways shall comply with Section 403.6.1.5.3.

17 **Exceptions:**

- 18 1. Enclosed fire service access elevator lobbies are not required at the *levels of*
19 *exit discharge.*
20 2. Enclosed fire service access elevator lobbies are not required for elevators with
21 *pressurized hoistways.*

22 **403.6.1.5.3 Lobby doorways.** Other than doors to the hoistway or elevator control
23 room, each doorway to a fire service access elevator lobby shall be provided with a

1 3/4-hour fire door assembly complying with Section 716.5. The fire door assembly
2 shall also comply with the smoke and draft control door assembly requirements of
3 Section 716.5.3.1 with the UL 1784 test conducted without the artificial bottom seal.

4 **403.6.1.5.4 Lobby size.** Regardless of the number of fire service access elevators
5 served by the same elevator lobby, the enclosed fire service access elevator lobby
6 shall be not less than 150 square feet (14 m2) in area with a minimum dimension of 8
7 feet (2440 mm).

8 **403.6.1.5.5 Fire service access elevator symbol.** A pictorial symbol of a
9 standardized design designating which elevators are fire service access elevators shall
10 be installed on each side of the hoistway door frame on the portion of the frame at
11 right angles to the fire service access elevator lobby. The fire service access elevator
12 symbol shall be designed as shown in Figure 403.6.1.5.5 and shall comply with the
13 following:

- 14 1. The fire service access elevator symbol shall be not less than 3 inches (76
15 mm) in height.
- 16 2. The helmet shall contrast with the background, with either a light helmet on a
17 dark background or a dark helmet on a light background.
- 18 3. The vertical center line of the fire service access elevator symbol shall be
19 centered on the hoistway door frame. Each symbol shall be not less than 78
20 inches (1981 mm), and not more than 84 (2134 mm) inches above the finished
21 floor at the threshold.

FIGURE 403.6.1.5.5

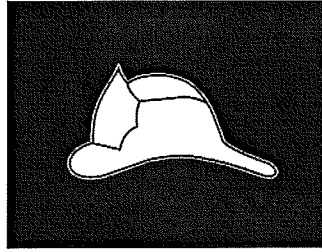

FIRE SERVICE ACCESS ELEVATOR SYMBOL

403.6.1.6 Elevator system monitoring. The fire service access elevator shall be continuously monitored at the fire command center by a standard emergency service interface system meeting the requirements of NFPA 72.

403.6.1.7 Protection of wiring or cables. Wires or cables that are located outside of the elevator hoistway and machine room and that provide normal or emergency power, control signals, communication with the car, lighting, heating, air conditioning, ventilation and fire-detecting systems to fire service access elevators shall be protected by construction having a *fire-resistance rating* of not less than 2 hours, shall be a circuit integrity cable having a *fire-resistance rating* of not less than 2 hours or shall be protected by a listed electrical protective system having a *fire-resistance rating* of not less than 2 hours.

Exception: Wiring and cables to control signals are not required to be protected provided that wiring and cables do not serve Phase II emergency in-car operations.

403.6.1.8 Standpipe hose connection. A Class I standpipe hose connection in accordance with Section 905 shall be provided in the interior exit stairway and ramp having direct access from the fire service access elevator lobby.

403.6.1.8.1 Access. The exit enclosure containing the standpipe shall have access to the floor without passing through the fire service access elevator lobby.

1 **403.6.2 Occupant evacuation elevators.** ~~((Where))~~ Elevators installed for compliance with
2 Section 403.5.2, ((in accordance with Section 3008, passenger elevators for general public
3 use)) shall comply with Sections 403.6.2.1 through 403.6.2.10.1. ((be permitted to be used
4 for occupant self-evacuation.)) Where other elevators are used for occupant self-evacuation,
5 they shall also comply with these sections.

6 **403.6.2.1 Number of occupant evacuation elevators.** The number of elevators available
7 for occupant evacuation shall be determined based on an egress analysis that addresses
8 both of the following scenarios:

- 9 1. Full building evacuation where the analysis demonstrates that the number of
10 elevators provided for evacuation results in an evacuation time less than one hour.
- 11 2. Evacuation of the 4 consecutive floors with the highest cumulative occupant load
12 where the analysis demonstrates that the number of elevators provided for
13 evacuation results in an evacuation time less than 15 minutes. Floors that are not
14 atmospherically separated are considered one floor.

15 A minimum of one elevator in each elevator group shall be designated for occupant
16 evacuation. Not less than two shall be provided in each occupant evacuation elevator
17 lobby where more than one elevator opens into the lobby. Signage shall be provided to
18 denote which elevators are available for occupant evacuation.

19 **403.6.2.2 Fire safety and evacuation plan.** The building shall have an approved fire
20 safety and evacuation plan in accordance with the applicable requirements of Section 404
21 of the International Fire Code. The fire safety and evacuation plan shall incorporate
22 specific procedures for the occupants using evacuation elevators.

1 **403.6.2.3 Operation.** The occupant evacuation elevators shall be used for occupant self-
2 evacuation in accordance with the occupant evacuation operation requirements in ASME
3 A17.1/CAS B44 and the building's fire safety and evacuation plan.

4 **403.6.2.4 Water protection.** An approved method to prevent water from infiltrating into
5 the hoistway enclosure from the operation of the automatic sprinkler system outside the
6 enclosed occupant evacuation elevator lobby shall be provided.

7 **403.6.2.5 Hoistway enclosure protection.** Occupant evacuation elevator hoistways shall
8 be located in shaft enclosures complying with Section 713.

9 **403.6.2.6 Occupant evacuation elevator lobby.** The occupant evacuation elevators shall
10 open into an elevator lobby in accordance with Sections 403.6.2.6 through 403.6.2.6.6.
11 Egress is permitted through the elevator lobby in accordance with Item 1 of Section
12 1016.2.

13 **403.6.2.6.1 Access to interior exit stairway or ramp.** The occupant evacuation
14 elevator lobby shall have *direct access* from the enclosed elevator lobby to an *interior*
15 *exit stairway or ramp.*

16 **Exceptions:**

- 17 1. Access to an *interior exit stairway or ramp* shall be permitted to be
18 through a protected path of travel that has a level of fire protection not
19 less than the elevator lobby enclosure. The protected path shall be
20 separated from the enclosed elevator lobby through an opening protected
21 by a smoke and draft control assembly in accordance with Section
22 716.5.3.

1 2. Elevators that only service an open parking garage and the lobby of the
2 building shall not be required to provide direct access in accordance with
3 this section.

4 **403.6.2.6.2 Lobby enclosure.** The occupant evacuation elevator lobby shall be
5 enclosed with a smoke barrier having a fire-resistance rating of not less than 1 hour,
6 except that lobby doorways shall comply with Section 403.6.2.6.3.

7 **Exception:** Enclosed occupant evacuation elevator lobbies are not required at the
8 levels of exit discharge.

9 **403.6.2.6.3 Lobby doorways.** Other than the doors to the hoistway, elevator machine
10 rooms, machinery spaces and control rooms within the lobby enclosure smoke barrier,
11 each doorway to an occupant evacuation elevator lobby shall be provided with a 3/4-
12 hour fire door assembly complying with Section 716.5. The fire door assembly shall
13 comply with the smoke and draft control assembly requirements of Section 716.5.3.1
14 with the UL 1784 test conducted without the artificial bottom seal.

15 **403.6.2.6.3.1 Vision panel.** A vision panel shall be installed in each fire door
16 assembly protecting the lobby doorway. The vision panel shall consist of fire-
17 protection-rated glazing and shall be located to furnish clear vision of the
18 occupant evacuation elevator lobby.

19 **403.6.2.6.3.2 Door closing.** Each fire door assembly protecting the lobby
20 doorway shall be automatic-closing upon receipt of any fire alarm signal from the
21 emergency voice/alarm communication system serving the building.

22 **403.6.2.6.4 Lobby size.** Each occupant evacuation elevator lobby shall have
23 minimum floor area as follows:

1 1. The occupant evacuation elevator lobby floor area shall accommodate, at 3
2 square feet (0.28 m²) per person, not less than 25 percent of the occupant load
3 of the floor area served by the lobby.

4 2. The occupant evacuation elevator lobby floor area also shall accommodate one
5 wheelchair space of 30 inches by 48 inches (760 mm by 1220 mm) for each 50
6 persons, or portion thereof, of the occupant load of the floor area served by the
7 lobby.

8 **Exception:** The size of lobbies serving multiple banks of elevators shall have the
9 minimum floor area approved on an individual basis and shall be consistent with
10 the building's fire safety and evacuation plan.

11 **403.6.2.6.5 Signage.** An approved sign indicating elevators are suitable for occupant
12 self-evacuation shall be posted on all floors adjacent to each elevator call station
13 servicing occupant evacuation elevators.

14 **403.6.2.6.6 Two-way communication system.** A two-way communication system
15 shall be provided in each occupant evacuation elevator lobby for the purpose of
16 initiating communication with the fire command center or an alternate location
17 approved by the fire department. The two-way communication system shall be
18 designed and installed in accordance with Sections 1009.8.1 and 1009.8.2.

19 **403.6.2.7 Elevator system monitoring.** The occupant evacuation elevators shall be
20 continuously monitored at the fire command center or a central control point approved by
21 the fire department and arranged to display all of the following information:

22 1. Floor location of each elevator car.

23 2. Direction of travel of each elevator car.

1 3. Status of each elevator car with respect to whether it is occupied.

2 4. Status of normal power to the elevator equipment, elevator machinery and
3 electrical apparatus cooling equipment where provided, elevator machine room
4 and control room ventilation and cooling equipment.

5 5. Status of the emergency power system that provides backup power to the
6 elevator equipment, elevator machinery and electrical cooling equipment where
7 provided, elevator machine room and control room *ventilation* and cooling
8 equipment.

9 6. Activation of any fire alarm initiating device in any elevator lobby, elevator
10 machine room, machine space containing a motor controller or electric driving
11 machine, control room or elevator hoistway.

12 **403.6.2.8 Elevator recall.** The fire command center or an alternate location approved by
13 the fire department shall be provided with the means to manually initiate a Phase I
14 Emergency Recall of the occupant evacuation elevators in accordance with ASME
15 A17.1/CSA B44.

16 **403.6.2.9 Protection of wiring or cables.** Wires or cables that are located outside of the
17 elevator hoistway, and machine room and control room and that provide normal or
18 emergency power, control signals, communication with the car, lighting, heating, air
19 conditioning, *ventilation* and fire-detecting systems to occupant evacuation elevators
20 shall be protected by construction having a *fire-resistance rating* of not less than 2 hours,
21 shall be circuit integrity cable having a fire-resistance rating of not less than 2 hours or
22 shall be protected by a listed electrical circuit protective system having a fire-resistance
23 rating of not less than 2 hours.

1 **Exception:** Wiring and cables to control signals that do not serve Phase II emergency
2 in-car operations are not required to be protected.

3 **403.6.2.10 Emergency voice/alarm communication system.** The building shall be
4 provided with an emergency voice/alarm communication system. The emergency
5 voice/alarm communication system shall be accessible to the fire department. The system
6 shall be provided in accordance with Section 907.5.2.2.

7 **403.6.2.10.1 Notification appliances.** No fewer than one audible and one visible
8 notification appliance shall be installed within each occupant evacuation elevator
9 lobby.

10 **403.7 Emergency operational plan.** Prior to the issuance of a Certificate of Occupancy, the
11 owner-occupant of the building shall assign a responsible person as the building's Fire Safety
12 Director to work with the fire code official in establishing an operational plan for the building.
13 The operational plan shall contain the guidelines and procedures to be followed and
14 responsibilities of the fire department, building employees, and tenants under emergency
15 conditions, including special provisions for persons with disabilities. The plan shall also include
16 procedures for operation, maintenance and testing of the life safety systems and the allowable
17 use and occupancy of each portion of the building. One copy of the operational plan shall be
18 filed with the fire code official, and one shall be posted in the central control station prior to
19 issuance of the Certificate of Occupancy.

20 **403.8 Signs.** Signs complying with Sections 403.8.1 through 403.8.4 shall be provided in *high-*
21 *rise buildings.*

22 **403.8.1 Elevator lobbies.** A sign shall be posted in every elevator lobby above each hall
23 call fixture noting that the elevators will be recalled to the building lobby on fire alarm.

1 **Exception:** If approved by the *building official*, signs need not be posted in lobbies at the
2 main egress level if the means of egress are obviously identifiable.

3 **403.8.2 Recall floor lobbies.** A sign indicating the number of each elevator shall be posted
4 and maintained in the elevator lobby at each designated recall floor and at alternate floors of
5 recall, if provided.

6 **403.8.3 Stair re-entry signs.** A sign shall be posted on each floor landing within a stairway
7 indicating where re-entry is provided into the building or indicating the location of
8 telephones or other means of two-way communication.

9 **403.8.4 Other signs.** Other signs required by this code, including but not limited to stairway
10 identification signs required by Section 1023.9 and exit signs required by Section 1013, shall
11 be provided

12 **SECTION 404**

13 **ATRIUMS**

14 **404.1 General.** In other than Group H occupancies, and where permitted by Section 712.1.7, the
15 provisions of Sections 404.1 through 404.10 shall apply to buildings or structures containing
16 vertical openings defined as “Atriums.”

17 **404.1.1 Definition.** The following term is defined in Chapter 2:

18 **ATRIUM.**

19 **404.1.2 Presubmittal conference.** At least 60 days prior to application, the applicant shall
20 arrange a presubmittal conference with the design team, the building official and the fire code
21 official. The purpose of the meeting is to obtain conceptual approval from the building
22 official and the fire code official. The documentation of the presubmittal meeting shall be

1 reflected on the plans for the building and become a permanent part of the Department of
2 Construction and Inspection's records.

3 ***

4 [F] **404.3 Automatic sprinkler protection.** *An approved automatic sprinkler system shall be*
5 *installed throughout the entire building.*

6 **Exceptions:**

- 7 1. That area of a building adjacent to or above the *atrium* need not be sprinklered
8 provided that portion of the building is separated from the *atrium* portion by not less
9 than 2-hour *fire barriers* constructed in accordance with Section 707 or *horizontal*
10 *assemblies* constructed in accordance with Section 711, or both.
- 11 2. Where the ceiling of the *atrium* is more than 55 feet (16764 mm) above ~~((the floor))~~
12 any floor area open to the atrium, sprinkler protection at the ceiling of the *atrium* is not
13 required.

14 ***

15 **404.6 Enclosure of atriums.** *Atrium* spaces shall be separated from adjacent spaces by a 1-hour
16 *fire barrier* constructed in accordance with Section 707 or a *horizontal assembly* constructed in
17 accordance with Section 711, or both.

18 **Exceptions:**

- 19 1. A *fire barrier* is not required where a glass wall forming a smoke partition is provided.
20 The glass wall shall comply with all of the following:
- 21 1.1. Automatic sprinklers are provided along both sides of the separation wall and
22 doors, or on the room side only if there is not a walkway on the *atrium* side. The
23 sprinklers shall be located between 4 inches and 12 inches (102 mm and 305 mm)

1 away from the glass and at intervals along the glass not greater than 6 feet (1829
2 mm). The sprinkler system shall be designed so that the entire surface of the glass
3 is wet upon activation of the sprinkler system without obstruction;

4 1.2. The glass wall shall be installed in a gasketed frame in a manner that the framing
5 system deflects without breaking (loading) the glass before the sprinkler system
6 operates; and

7 1.3. Where glass doors are provided in the glass wall, they shall be either *self-closing*
8 or automatic-closing.

9 2. A fire barrier is not required where a glass-block wall assembly complying with
10 Section 2110 and having a 3/4-hour fire protection rating is provided.

11 3. A fire barrier is not required between the atrium and the adjoining spaces of any three
12 floors of the atrium provided such spaces are accounted for in the design of the smoke
13 control system.

14 4. A fire barrier is not required between the atrium and the adjoining spaces for atriums
15 that connect only two stories.

16 **Code Alternate CA404.6:** The separation between the atrium and tenant spaces that are
17 not guest rooms or dwelling units is permitted to be omitted on four floors when:

18 1. The building is of Type IA or IB construction;

19 2. The perimeter of the opening is protected by draft curtains and a row of automatic
20 sprinklers not more than 6 feet (1829 mm) on center as required for escalator
21 protection;

22 3. All spaces of the building separated from the atrium by less than 1-hour fire-
23 resistive construction are equipped with an automatic smoke detection system;

1 4. Tenant spaces open to the atrium have access to two interior exit stairways
2 separated by one-half the building diagonal with one exit located so that occupants
3 can exit in a direction away from the atrium. For the purpose of this requirement
4 “away from the atrium” means not being forced to exit parallel and adjacent to the
5 atrium opening. “Areas open to the atrium” are those areas that are not separated
6 from the atrium with at least a 1-hour fire barrier.

7 **[F] 404.7 ((Standby)) Emergency power system.** Equipment required to provide smoke control
8 shall be provided with ((standby)) an emergency power system in accordance with Section
9 909.11.

10 **Code Alternate CA404.7:** An emergency power system is not required for smoke control
11 systems in buildings that have at least two exits and atriums with a total volume of less than
12 40,000 cubic feet (1133 m³).

13 ***

14 SECTION 405

15 UNDERGROUND BUILDINGS

16 **405.1 General.** The provisions of Sections 405.2 through 405.9 apply to building spaces having
17 a floor level used for human occupancy more than 30 feet (9144 mm) below the finished floor of
18 the lowest *level of exit discharge*.

19 **Exceptions:** The provisions of Section 405 are not applicable to the following buildings or
20 portions of buildings:

- 21 1. One- and two-family *dwelling*s, sprinklered in accordance with Section 903.3.1.3.
- 22 2. Parking garages provided with *automatic sprinkler systems* in compliance with Section
23 405.3.

1 3. Fixed guideway transit systems that comply with NFPA 130 as amended.

2 4. *Grandstands, bleachers*, stadiums, arenas and similar facilities.

3 5. Where the lowest *story* is the only *story* that would qualify the building as an
4 underground building and has an area not greater than 1,500 square feet (139 m²) and
5 has an *occupant load* less than 10.

6 6. Pumping stations and other similar mechanical spaces intended only for limited
7 periodic use by service or maintenance personnel.

8 ***

9 **405.7 Means of egress.** *Means of egress* shall be in accordance with Sections 405.7.1 and
10 405.7.2.

11 **405.7.1 Number of exits.** Each floor level shall be provided with no fewer than two *exits*.

12 Where compartmentation is required by Section 405.4, each compartment shall have no
13 fewer than one *exit* and shall also have no fewer than one *exit access* doorway into the
14 adjoining compartment.

15 **405.7.2 ((Smokeproof enclosure)) Smoke control in exit stairways.** Every required
16 *stairway* serving floor levels more than 30 feet (9144 mm) below the finished floor of its
17 *level of exit discharge* shall comply with ((the requirements for a *smokeproof enclosure* as
18 ~~provided in~~)) Section 1023.11.

19 **[F] 405.8 ((Standby and e))Emergency power system.** ((A standby power system complying
20 with Section 2702 shall be provided for the standby power loads specified in Section 405.8.1.))

21 An emergency power system complying with Section 2702 shall be provided for the emergency
22 power loads specified in Section 405.8.2.

1 ~~(([F] 405.8.1 Standby power loads. The following loads are classified as standby power~~
2 ~~loads:~~

- 3 ~~1. Smoke control system.~~
- 4 ~~2. Ventilation and automatic fire detection equipment for smokeproof enclosures.~~
- 5 ~~3. Fire pumps.~~
- 6 ~~4. Elevators, as required in Section 3003.)~~

7 **[F] 405.8.((2))1 Emergency power loads.** The following loads are classified as emergency
8 power loads:

- 9 1. *Emergency voice/alarm communications systems.*
- 10 2. *Fire alarm systems.*
- 11 3. *Automatic fire detection systems.*
- 12 4. *Elevator car lighting.*
- 13 5. *Means of egress and exit sign illumination as required by Chapter 10.*
- 14 6. Smoke control systems.
- 15 7. Ventilation and automatic fire detection equipment for pressurized interior exit
16 stairways.
- 17 8. Fire pumps.
- 18 9. Lighting for elevator cars, machine rooms, machine spaces and control rooms.
- 19 10. Ventilation and automatic fire detection equipment for pressurized stairways and
20 elevator hoistways.
- 21 11. A selected elevator in each bank in accordance with Section 3016.6. A bank of
22 elevators is a group of elevators or a single elevator controlled by a common

1 operating system. All elevators that respond to a single call button constitute a bank
2 of elevators. All elevators shall be transferable to an emergency power system.

3 **Note:** There is no limit on the number of cars that are permitted to be in a bank, but no
4 more than four cars are permitted within a common hoistway. See Section 3016.7.

5 ***

6 **SECTION 406**

7 **MOTOR-VEHICLE-RELATED OCCUPANCIES**

8 **406.1 General.** Motor-vehicle-related occupancies shall comply with Sections 406.1 through
9 406.8.

Note: The Seattle Electrical Code requires that all occupancies provide one of the following
to facilitate future installation of electric vehicle charging outlets:

1. Reserved space in the electrical service equipment for installation of an overcurrent
protective device for electric vehicle charging system branch circuits, or
2. A designated location and working clearances for a future electric vehicle charging
system panelboard.

See Seattle Electrical Code 625.27 for details.

10 ***

11 **406.3.2 Clear height.** In private garages and carports, the clear height in vehicle and
12 pedestrian traffic areas shall be not less than (~~7 feet (2134 mm)~~) 6 feet 6 inches (1981 mm).

13 Vehicle and pedestrian areas accommodating van-accessible parking shall comply with
14 Section 1106.5.

15 ***

1 **406.4 Public parking garages.** Parking garages, other than *private garages*, shall be classified
2 as public parking garages and shall comply with the provisions of Sections 406.4.2 through
3 406.4.8 and shall be classified as either an *open parking garage* or an enclosed parking garage.
4 *Open parking garages* shall also comply with Section 406.5. Enclosed parking garages shall also
5 comply with Section 406.6. See Section 510 for special provisions for parking garages.

6 **406.4.1 Clear height.** The clear height of each floor level in vehicle and pedestrian traffic
7 areas shall be not less than ~~((7 feet (2134 mm))~~ 6 feet 6 inches (1981 mm). Vehicle and
8 pedestrian areas accommodating van-accessible parking shall comply with Section 1106.5.

9 **406.4.2 Guards.** Guards shall be provided in accordance with Section 1015. Guards serving
10 as *vehicle barriers* shall comply with Sections 406.4.3 and 1015.

11 **406.4.3 Vehicle barriers.** *Vehicle barriers* not less than 2 feet 9 inches (835 mm) in height
12 shall be placed where the vertical distance from the floor of a drive lane or parking space to
13 the ground or surface directly below is greater than 1 foot (305 mm). *Vehicle barriers* shall
14 comply with the loading requirements of Section 1607.8.3.

15 **Exception:** *Vehicle barriers* are not required in vehicle storage compartments in a
16 mechanical access parking garage.

17 **406.4.4 Ramps.** Vehicle ramps shall not be considered as required *exits* unless pedestrian
18 facilities are provided. Vehicle ramps that are utilized for vertical circulation as well as for
19 parking shall not exceed a slope of 1:15 (6.67 percent).

20 **406.4.5 Floor surface.** Parking surfaces shall be of concrete or similar noncombustible and
21 nonabsorbent materials.

22 ~~((The area of floor used for parking of automobiles or other vehicles shall be sloped to
23 facilitate the movement of liquids to a drain or toward the main vehicle entry doorway.))~~

SECTION 407

GROUP I-2

407.4.4 Group I-2 care suites. *Care suites* in Group I-2 shall comply with Sections 407.4.4.1 through 407.4.4.4 and either Section 407.4.4.5 or 407.4.4.6.

407.4.4.1 Exit access through care suites. *Exit* access from all other portions of a building not classified as a *care suite* shall not pass through a *care suite*. In a *care suite* required to have more than one *exit*, one *exit access* is permitted to pass through an adjacent *care suite* provided all of the other requirements of Sections 407.4 and 1016.2 are satisfied.

[W] 407.4.4.2 Separation. *Care suites* shall be separated from other portions of the building, including other care suites, by a smoke partition complying with Section 710. Partitions within suites are not required to be smoke resistant or fire resistance rated unless required by another section of this code.

407.5.3 Horizontal assemblies. Horizontal assemblies supporting smoke barriers required by this section shall be designed to resist the movement of smoke. Elevator lobbies shall be in accordance with Section (~~3006.2~~) 713.14.

SECTION 412

AIRCRAFT-RELATED OCCUPANCIES

412.3.2 Stairways. Stairways in airport traffic control towers shall be in accordance with Section 1011. Stairways shall be pressurized in accordance with Section 909.20 or 909.21.

1 ((smokeproof enclosures complying with one of the alternatives provided in Section
2 909.20.))

3 **Exception:** Stairways in airport traffic control towers are not required to comply with
4 Section 1011.12.

5 ***

6 **412.4.6.3 Restrictions in the Fire District.** Aircraft hangars shall not be located in the
7 Fire District unless work is limited to exchange of parts and maintenance requiring no
8 open flame or welding.

9 ***

10 **412.3.7.1 Elevators for occupant evacuation.** Where provided in addition to an exit
11 stairway, occupant evacuation elevators shall be in accordance with Section ((3008))
12 403.6.2.

13 ***

14 **412.8.6 Restrictions in the Fire District.** Heliports shall not be located in the *Fire District.*

15 ***

16 SECTION 413

17 COMBUSTIBLE STORAGE

18 ***

19 **413.3 Mini-storage warehouses.** In mini-storage warehouse buildings, individual storage
20 lockers shall be separated from each other with fire partitions.

21 **Exception:** The separation between individual storage lockers is permitted to be non-rated in
22 rooms 500 square feet (46 m²) or less in area and in sprinklered rooms of any size.

1 **413.4 Basement storage and sale of combustible materials.** Storage and sale of combustible
2 material in basements shall be in accordance with Sections 413.4.1 through 413.4.5.

3 **Exception:** Areas protected with an approved automatic sprinkler system that are separated
4 from other areas in the basement by fire barriers with at least a one-hour fire resistance rating
5 are not required to comply with this section.

6 **413.4.1 Storage room size.** Combustible material being stored or available for sales shall be
7 placed in rooms no larger than 500 square feet (46.5 m²).

8 **413.4.2 Storage room construction.** Each storage room shall be separated from other areas
9 by fire barriers with at least a one hour fire-resistance rating.

10 **413.4.3 Number of storage rooms.** There shall be a maximum of three storage rooms within
11 any one basement.

12 **413.4.4 Storage room access.** Each storage room shall be provided with access directly from
13 the building exterior, or through a one-hour fire resistance rated corridor between each room
14 and an exterior door or exit enclosure.

15 **413.4.5 Storage room restrictions.** Storage rooms shall not contain any material classified as
16 a flammable liquid, hazardous material, or highly combustible material.

SECTION 414

HAZARDOUS MATERIALS

20 **414.1.4 Presubmittal conference.** Prior to application for a permit for a Group H-5
21 Occupancy, the applicant shall arrange a presubmittal conference with the design team, the
22 building official and fire code official to review the proposed emergency life safety systems
23 for the building and the appropriate protection of the life safety systems. For Group H-4

1 occupancies, a presubmittal conference is recommended. The purpose of the meeting is to
2 obtain conceptual approval from the *building official* and the fire code official of the
3 proposed systems.

4 Applicants shall bring to the conference preliminary building plans and a draft of the
5 Hazardous Materials Management Plan. The building permit shall not be issued until the
6 *building official* and fire code official have *approved*, in writing, the emergency life safety
7 systems for the building and the protection of the life safety systems. The documentation of
8 the presubmittal meeting shall be reflected on the plans for the building and become a
9 permanent part of the Department of Construction and Inspection's records.

10 **414.1.5 Hazardous material areas in buildings over 420 feet in building height. In**
11 **buildings in which an occupant evacuation elevator is used to comply with Section 403.6.2,**
12 **no building areas shall contain hazardous materials exceeding the maximum allowable**
13 **quantities per *control area* as addressed in Section 414.2.**

14 **[F] 414.2 Control areas.** *Control areas* shall comply with Sections 414.2.1 through 414.2.5 and
15 the *International Fire Code*.

16 **[F] 414.2.1 Construction requirements.** *Control areas* shall be separated from each other
17 by *fire barriers* constructed in accordance with Section 707 or *horizontal assemblies*
18 constructed in accordance with Section 711, or both.

19 **[F] 414.2.2 Percentage of maximum allowable quantities.** The percentage of maximum
20 allowable quantities of hazardous materials per *control area* permitted at each floor level
21 within a building shall be in accordance with Table 414.2.2.

22 **Exception: *Non-production laboratory facilities* are permitted to be in accordance with**
23 **Section 414.7.**

1 [F] **414.2.3 Number.** The maximum number of *control areas* within a building shall be in
2 accordance with Table 414.2.2.

3 **Exception:** *Non-production laboratory facilities are permitted to be in accordance with*
4 *Section 414.7.*

5 [F] **414.2.4 Fire-resistance-rating requirements.** The required *fire-resistance rating* for *fire*
6 *barriers* shall be in accordance with Table 414.2.2 or Table 414.7 for *non-production*
7 *laboratory facilities.* The floor assembly of the *control area* and the construction supporting
8 the floor of the *control area* shall have a *fire-resistance rating* of not less than 2 hours.

9 **Exception:** The floor assembly of the *control area* and the construction supporting the
10 floor of the *control area* are allowed to be 1-hour fire-resistance rated in buildings of
11 Types IIA, IIIA and VA construction, provided that both of the following conditions exist:

- 12 1. The building is equipped throughout with an *automatic sprinkler system* in
13 accordance with Section 903.3.1.1; and
- 14 2. The building is three or fewer *stories above grade plane.*

15 ***

16 [F] **414.5 Inside storage, dispensing and use.** The inside storage, dispensing and use of
17 hazardous materials shall be in accordance with Sections 414.5.1 through 414.5.3 of this code
18 and the *International Fire Code.*

19 [F] **414.5.1 Explosion control.** Explosion control shall be provided in accordance with the
20 *International Fire Code* as required by Table 414.5.1 where quantities of hazardous materials
21 specified in that table exceed the maximum allowable quantities in Table 307.1(1) or where a
22 structure, room or space is occupied for purposes involving explosion hazards as required by
23 Section 415 or the *International Fire Code.*

1 **414.7.2 Fire-resistance-rating requirements.** The required fire-resistance rating for fire
2 barriers shall be in accordance with Table 414.7 for non-production laboratory facilities.

3 **414.7.3 Storage.** Storage in control areas shall be in accordance with this code and Sections
4 414.7.3.1 through 414.7.3.2.

5 **414.7.3.1 Density.** Storage of Class I flammable liquids shall not exceed 4 gallons per
6 100 square feet (0.13 L/m²) of floor area above floor level 6.

7 **414.7.3.2 Container size.** Individual containers in storage shall not exceed 1 gallon (3.8
8 L) for Class I flammable liquids.

9 **414.7.4 Automatic sprinkler system.** An approved automatic sprinkler system shall be
10 installed throughout a building containing a non-production laboratory facility. The sprinkler
11 system shall be designed to protect an ordinary hazard group 2 occupancy.

Table 414.7
Design and Number of Control Areas in Non-production Laboratory Facilities^a

| <u>Floor Level</u> | | <u>Percentage of the Maximum Allowable Quantity per Control Area^b</u> | <u>Number of Control Areas per Floor</u> | <u>Fire-resistance Rating for Fire Barriers in Hours^{c, d}</u> |
|--------------------------|-----------------------|--|--|---|
| <u>Above Grade Plane</u> | <u>Higher than 20</u> | <u>Not Allowed</u> | <u>Not Allowed</u> | <u>Not Allowed</u> |
| | <u>6-20</u> | <u>15</u> | <u>2</u> | <u>2</u> |
| | <u>5</u> | <u>25</u> | <u>2</u> | <u>2</u> |
| | <u>4</u> | <u>25</u> | <u>2</u> | <u>2</u> |
| | <u>3</u> | <u>50</u> | <u>2</u> | <u>2</u> |
| | <u>2</u> | <u>75</u> | <u>2</u> | <u>1</u> |
| | <u>1</u> | <u>100</u> | <u>2</u> | <u>1</u> |
| <u>Below Grade Plane</u> | <u>1</u> | <u>75</u> | <u>2</u> | <u>1</u> |
| | <u>2</u> | <u>50</u> | <u>2</u> | <u>1</u> |
| | <u>Lower than 2</u> | <u>Not Allowed</u> | <u>Not Allowed</u> | <u>Not Allowed</u> |

- a. Table 414.7 applies to non-production laboratory facilities meeting the criteria of Section 414.7.
- b. Percentages shall be of the maximum allowable quantity per control area shown in Tables 307.1(1) and 307.1 (2) with all increases allowed in the footnotes to those tables.
- c. Fire barriers shall include walls and floors as necessary to provide separation from other portions of the building.
- d. Vertical fire barriers separating control areas from other spaces on the same floor may be one-hour rated.

SECTION 415

GROUPS H-1, H-2, H-3, H-4 AND H-5

[F] 415.6.1 Group H occupancy minimum fire separation distance. Regardless of any other provisions, buildings containing Group H occupancies shall be set back to the minimum *fire separation distance* as set forth in Sections 415.6.1.1 through 415.6.1.4. Distances shall be measured from the walls enclosing the occupancy to *lot lines*, including those on a public way. Distances to assumed *lot lines* established for the purpose of determining exterior wall and opening protection are not to be used to establish the minimum *fire separation distance* for buildings on sites where explosives are manufactured or used

1 when separation is provided in accordance with the quantity distance tables specified for
2 explosive materials in the *International Fire Code*.

3 [F] 415.6.1.1 Group H-1. Group H-1 occupancies shall be set back not less than 75 feet
4 (22 860 mm) and not less than required by the *International Fire Code*.

5 (~~(Exception: Fireworks manufacturing buildings separated in accordance with NFPA~~
6 ~~1124.))~~)

7 415.6.1.1.1 Restrictions in the Fire District. Group H-1 occupancies shall not be
8 located in the *Fire District*.

9 [F] 415.6.1.2 Group H-2. Group H-2 occupancies shall be set back not less than 30 feet
10 (9144 mm) where the area of the occupancy is greater than 1,000 square feet (93 m²) and
11 it is not required to be located in a *detached building*.

12 415.6.1.2.1 Restrictions in the Fire District. Group H-2 occupancies having a floor
13 area in excess of 500 square feet (46 m²) are not permitted in the Fire District. Group
14 H-3 Occupancies having a floor area in excess of 1,500 square feet (139 m²) are not
15 permitted in the Fire District.

16 ***

17 [F] 415.9.3 Dry cleaning plants. The construction and installation of dry cleaning plants
18 shall be in accordance with the requirements of this code, the *International Mechanical*
19 *Code*, the (~~(International))~~ *Uniform Plumbing Code* and NFPA 32. Dry cleaning solvents and
20 systems shall be classified in accordance with the *International Fire Code*.

21 ***

22 [F] 415.11.1.8 Electrical. Electrical equipment and devices within the *fabrication area*
23 shall comply with (~~(NFPA 70))~~ the *Seattle Electrical Code*. The requirements for

1 hazardous locations need not be applied where the average air change is at least four
2 times that set forth in Section 415.11.1.6 and where the number of air changes at any
3 location is not less than three times that required by Section 415.11.1.6. The use of
4 recirculated air shall be permitted.

5 ***

6 **[F] 415.11.10 Emergency power system.** An emergency power system shall be provided in
7 Group H-5 occupancies in accordance with Section 2702. The emergency power system shall
8 supply power automatically to the electrical systems specified in Section 415.11.10.1 when
9 the normal electrical supply system is interrupted.

10 **[F] 415.11.10.1 Required electrical systems.** (~~Emergency~~) An emergency power
11 system shall be provided for electrically operated equipment and connected control
12 circuits for the following systems:

- 13 1. HPM exhaust ventilation systems.
- 14 2. HPM gas cabinet ventilation systems.
- 15 3. HPM exhausted enclosure ventilation systems.
- 16 4. HPM gas room ventilation systems.
- 17 5. HPM gas detection systems.
- 18 6. Emergency alarm systems.
- 19 7. Manual and automatic fire alarm systems.
- 20 8. Automatic sprinkler system monitoring and alarm systems.
- 21 9. Automatic alarm and detection systems for pyrophoric liquids and Class 3
22 water-reactive liquids required in Section 2705.2.3.4 of the International Fire
23 Code.

1 10. Flow alarm switches for pyrophoric liquids and Class 3 water-reactive liquids
2 cabinet exhaust ventilation systems required in Section 2705.2.3.4 of the
3 International Fire Code.

4 11. Electrically operated systems required elsewhere in this code or in the
5 International Fire Code applicable to the use, storage or handling of HPM.

6 ***

7 **SECTION 419**

8 **LIVE/WORK UNITS**

9 **419.1 General.** A *live/work unit* shall comply with Sections 419.1 through 419.9.

10 **Exception:** Dwelling or sleeping units that include an office that is less than 10 percent of
11 the area of the *dwelling unit* are permitted to be classified as *dwelling units* with accessory
12 occupancies in accordance with Section 508.2.

13 **419.1.1 Limitations.** The following shall apply to all live/work areas:

14 1. The *live/work unit* is permitted to be not greater than 3,000 square feet (279 m²) in
15 area;

16 2. The nonresidential area is permitted to be not more than 50 percent of the area of each
17 *live/work unit*.((;))

18 ~~((3. The nonresidential area function shall be limited to the first or main floor only of the
19 *live/work unit*; and~~

20 ~~4. Not more than five nonresidential workers or employees are allowed to occupy the
21 nonresidential area at any one time.))~~

22 **419.2 Occupancies.** *Live/work units* shall be classified as a Group R-2 or Group R-3 occupancy.

23 Separation requirements found in Section ~~((s-420 and))~~ 508 shall not apply within the *live/work*

1 *unit* where the *live/work unit* is in compliance with Section 419 and 420. Nonresidential uses that
2 would otherwise be classified as either a Group H or S occupancy shall not be permitted in a
3 *live/work unit*.

4 **Exception:** Storage shall be permitted in the *live/work unit* provided the aggregate area of
5 storage in the nonresidential portion of the *live/work unit* shall be limited to 10 percent of the
6 space dedicated to nonresidential activities.

7 ***

8 **[F] 419.5 Fire protection.** The *live/work unit* shall be provided with a monitored *fire alarm*
9 system where required by Section 907.2.9. ~~((and an))~~ An automatic sprinkler system shall be
10 provided in accordance with:

- 11 1. Section ~~((903.2.8))~~ 903.3.1.2 or 903.3.1.3 for Group R occupancies in buildings with four
12 or fewer *dwelling units* that do not exceed two stories in height that are less than 5,000
13 square feet in area; or
14 2. Section 903.3.1.1 for all other buildings.

15 **419.6 Structural.** Floors within a *live/work unit* shall be designed for the live loads in Table
16 1607.1, based on the function within the space. The nonresidential portion of the unit shall be
17 designed for a live load of not less than 50 psf.

18 **419.7 Accessibility.** Accessibility shall be designed in accordance with Chapter 11 for the
19 function served.

20 **Interpretation I419.7:** Accessibility provisions for Group M occupancies shall be applied
21 unless the applicant specifies another occupancy.

22 ***

SECTION 420

GROUPS I-1, R-1, R-2, R-3 AND R-4

420.2 Separation walls. Walls separating *dwelling units* in the same building, walls separating *sleeping units* in the same building and walls separating *dwelling* or *sleeping units* from other occupancies contiguous to them in the same building shall be constructed as *fire partitions* in accordance with Section 708.

Interpretation I420: Separation provisions of Section 508 apply in addition to the separation requirements of Section 420.

420.7 Roof-ceiling soffits. Roof-ceiling soffits in dwelling units and sleeping units shall be provided with a minimum of 1/2-inch (13 mm) gypsum wallboard in buildings of Types IIB, IIIB and VB construction.

[W] 420.8 Licensed care cooking facilities. In Group I-1, Condition 2 assisted living facilities licensed under chapter 388-78A WAC and residential treatment facilities licensed under chapter 246-337 WAC, rooms or spaces that contain a cooking facility with domestic cooking appliances shall be permitted to be open to the corridor where all of the following criteria are met:

1. The number of care recipients housed in the smoke compartment is not greater than 30.
2. The number of care recipients served by the cooking facility is not greater than 30.
3. Only one cooking facility area is permitted in a smoke compartment.
4. The types of domestic cooking appliances permitted are limited to ovens, cooktops, ranges, warmers and microwaves.

- 1 5. The corridor is a clearly identified space delineated by construction or floor pattern,
2 material or color.
- 3 6. The space containing the domestic cooking facility shall be arranged so as not to obstruct
4 access to the required exit.
- 5 7. A domestic cooking hood installed and constructed in accordance with Section 505 of the
6 *International Mechanical Code* is provided over the cooktop or range.
- 7 8. The domestic cooking hood provided over the cooktop or range shall be equipped with an
8 automatic fire-extinguishing system of a type recognized for protection of domestic
9 cooking equipment. Preengineered automatic extinguishing systems shall be tested in
10 accordance with UL 300A and *listed* and *labeled* for the intended application. The system
11 shall be installed in accordance with this code, its listing and the manufacturer's
12 instructions.
- 13 9. A manual actuation device for the hood suppression system shall be installed in
14 accordance with Sections 904.12.1 and 904.12.2.
- 15 10. An interlock device shall be provided such that upon activation of the hood suppression
16 system, the power or fuel supply to the cooktop or range will be turned off.
- 17 11. A shut-off for the fuel and electrical power supply to the cooking equipment shall be
18 provided in a location that is accessible only to staff.
- 19 12. A timer shall be provided that automatically deactivates the cooking appliances within a
20 period of not more than 120 minutes.
- 21 13. A portable fire extinguisher shall be installed in accordance with Section 906 of the
22 *International Fire Code*.

1 **[W] 420.9 Adult family homes.** This section shall apply to all newly constructed adult family
2 homes and all existing single-family homes being converted to adult family homes. This section
3 shall not apply to those adult family homes licensed by the state of Washington Department of
4 Social and Health Services prior to July 1, 2001.

5 **420.9.1 Sleeping room classification.** Each sleeping room in an adult family home shall be
6 classified as one of the following:

7 1. Type S - Where the means of egress contains stairs, elevators or platform lifts.

8 2. Type NS1 - Where one means of egress is at grade level or a ramp constructed in
9 accordance with Section 1012 is provided.

10 3. Type NS2 - Where two means of egress are at grade level or ramps constructed in
11 accordance with Section 1012 are provided.

12 **420.9.2 Types of locking devices and door activation.** All bedrooms and bathroom doors
13 shall be openable from the outside when locked. Every closet door shall be readily openable
14 from the inside. Operable parts of door handles, pulls, latches, locks and other devices
15 installed in adult family homes shall be operable with one hand and shall not require tight
16 grasping, pinching, or twisting of the wrist. Pocket doors shall have graspable hardware
17 available when in the closed or open position.

18 The force required to activate operable parts shall be 5.0 pounds (22.2 N) maximum.

19 Required exit door(s) shall have no additional locking devices. Required exit door hardware
20 shall unlock inside and outside mechanisms when exiting the building allowing reentry into
21 the adult family home without the use of a key, tool or special knowledge.

1 **420.9.3 Smoke and carbon monoxide alarm requirements.** Alarms shall be installed in
2 such a manner so that the detection device warning is audible from all areas of the dwelling
3 upon activation of a single alarm.

4 **420.9.4 Escape windows and doors.** Every sleeping room shall be provided with emergency
5 escape and rescue windows as required by Section 1030. No alternatives to the sill height
6 such as steps, raised platforms or other devices placed by the openings will be approved as
7 meeting this requirement.

8 **420.9.5 Grab bar general requirements.** Where facilities are designated for use by adult
9 family home clients, grab bars for water closets, bathtubs and shower stalls shall be installed
10 according ICC A117.1.

11 **420.9.6 Shower stalls.** Where provided to meet the requirements for bathing facilities, the
12 minimum size of shower stalls for an adult family home shall be 30 inches deep by 48 inches
13 long.

14 **420.10 Security from criminal activity in Group R.**

15 **420.10.1 Group R occupancies other than one- and two-family dwellings.** All housing
16 units except one- and two-family dwellings shall comply with Section 420.10.1.

17 **420.10.1.1 Definition.** For the purposes of this section, “housing unit” is any dwelling
18 unit or guest room.

19 **420.10.1.2 Building entrance doors and locks.** Building entrance doors shall be
20 without openings and shall be as capable of resisting forcible entry as a flush solid core
21 wood door 1-3/8 inches (35 mm) thick.

1 **Exceptions:**

2 1. Building entrance doors are permitted to have visitor-observation ports that do not
3 impair the fire resistance of the door.

4 2. Main entrance doors are permitted to be framed or unframed non-shattering glass,
5 framed 1/4-inch (6 mm) plate glass or other security glazing.

6 3. Building entrance doors other than main entrance doors are permitted to have
7 glazed openings. Glazed openings shall have wire, grilles or security glazing to
8 prevent operation of the door latch from outside by hand or instrument.

9 Building entrance doors shall be self-closing, self-locking and equipped with a dead-
10 locking latch bolt with at least a 1/2-inch (13 mm) throw that shall penetrate the striker at
11 least 1/4 inch (6 mm).

12 **Exceptions:**

13 1. Building entrance doors that open directly into a housing unit shall comply with
14 Section 420.10.1.4.

15 2. Garage-to-building doors need not be self-locking when the garage-to-exterior
16 door is equipped with an electrically-operated remote control device for opening
17 and automatically closing.

18 3. When either the garage-to-exterior doors or garage-to-building doors are equipped
19 for self-closing and self-locking, the other need not be so equipped.

20 **420.10.1.3 Locks.** All *exit* doors, including those from individual housing units, shall be
21 openable from the interior without use of keys or special knowledge or effort.

1 **420.10.1.4 Housing unit doors and locks.** Doors from interior corridors to individual
2 housing units shall not have glass openings and shall be as capable of resisting forcible
3 entry as a flush solid core wood door 1-3/8 (35 mm) inches thick.

4 Every entrance door to a housing unit shall have a dead bolt or dead-locking latch bolt
5 with at least a 1/2-inch (13 mm) throw that penetrates the striker not less than 1/4 inch (6
6 mm). In hotels and other multi-unit buildings that provide housing for rent on a daily or
7 weekly basis, every entrance door to a housing unit shall also be provided with a chain
8 door guard or barrel bolt on the inside.

9 **420.10.1.5 Observation ports.** Every entrance door to a housing unit, other than
10 transparent doors, shall have a visitor-observation port. The port shall not impair the fire
11 resistance of the door. Observation ports shall be installed not less than 54 inches (1372
12 mm) and not more than 66 inches (1676 mm) above the floor.

13 **420.10.1.6 Non-exit doors.** Doors to storage, maintenance and building service rooms
14 shall be self-closing and self-locking.

15 **420.10.1.7 Sliding doors.** Dead bolts or other approved locking devices shall be
16 provided on all sliding doors. These locks shall be installed so that the mounting screws
17 for the lock cases are inaccessible from the outside.

18 **420.10.1.8 Windows.** Openable windows shall have operable inside latching devices.

19 **Exception:** Windows with sills located 10 feet (3048 mm) or more above grade, or
20 10 feet (3048 mm) or more above a deck, balcony or porch that is not readily
21 accessible from grade except through a housing unit need not have operable inside
22 latching devices.

1 **420.10.2 One- and two-family dwellings.** One- and two-family dwellings shall comply
2 with Section 420.10.2.

3 **420.10.2.1 Building entrance locks.** Building entrance doors, including garage doors,
4 shall be capable of locking. They shall be equipped with a dead-locking latch bolt with at
5 least a 1/2-inch (13 mm) throw that penetrates the striker not less than 1/4 inch (6 mm).
6 Building entrance doors shall be openable from the inside without use of a key or special
7 knowledge or effort.

8 **Exception:** Garage-to-exterior doors are permitted to be equipped with an
9 electronically-operated remote control device for opening and closing in lieu of a
10 dead-locking latch bolt. When garage-to-exterior doors are equipped with remote
11 control devices, garage-to-building doors need not be capable of locking.

12 **420.10.2.2 Observation ports.** Every building entrance door, other than garage doors,
13 shall have a visitor observation port or glass side light. Observation ports shall be
14 installed at a height of not less than 54 inches (1372 mm) and not more than 66 inches
15 (1676 mm) from the floor.

16 **420.10.2.3 Windows and sliding doors.** Dead bolts or other approved locking devices
17 shall be provided on all sliding doors and openable windows. The lock shall be installed
18 so that the mounting screws for the lock case are inaccessible from the outside.

19 **Exception:** Windows with sills located 10 feet (3048 mm) or more above grade, or
20 10 feet (3048 mm) or more above a deck, balcony or porch that is not readily
21 accessible from grade except through a housing unit need not have operable inside
22 latching devices.

1 420.10.3 Alternate security devices. Subject to the approval of the *building official*, alternate
2 security devices are permitted to be substituted for those required by this Section 420.10.
3 Alternate devices shall have equal capability to resist illegal entry. The installation of the device
4 shall not conflict with other requirements of this code and other ordinances regulating the safety
5 of exiting.

SECTION 421

HYDROGEN FUEL GAS ROOMS

8 ***

9 **[F] 421.8 Legally required standby ((Standby)) power.** Mechanical *ventilation* and gas
10 detection systems shall be provided with a legally required standby power system in accordance
11 with Section 2702.

12 ***

SECTION 427

WATERFRONT STRUCTURES: PIERS, WHARVES AND BUILDINGS

15 **427.1 Scope.** Structures with at least 20 percent or 8,000 square feet (743 m²), whichever is
16 greater, of their area over water shall comply with Section 427. They shall also comply with all
17 other requirements of this code unless otherwise specified in Section 427. Unless otherwise
18 specified, all wood dimensions are nominal size as defined in Section 202.

Exceptions:

- 20 1. Fire-resistance-rated walls specified in Section 427.7.6 are permitted to be used as one-
21 hour fire-resistance-rated fire barriers and as a separation between repair garages not
22 classified as Group S-1 and occupancies in Group A, including the specified opening
23 protection in buildings of Types IIB, IV and VB construction.

1 2. Structures accessory to Group R-3 occupancies.

2 3. Floating homes that comply with the Seattle Residential Code.

3 See Chapter 36 of the Fire Code for additional requirements for fire protection systems for
4 marinas.

5 427.2 Definitions. The following terms are defined in Chapter 2:

6 **COVERED BOAT MOORAGE.**

7 **PIER.**

8 **SUBSTRUCTURE.**

9 **SUPERSTRUCTURE.**

10 **WHARF.**

11 427.3 Allowable area and height for waterfront structures. The height of structures to be
12 built over water shall be measured as provided in Title 23 of the Seattle Municipal Code,
13 Sections 23.60A.952 and 23.60A.930 for Shoreline Districts. Height and area shall comply with
14 the requirements of Chapter 5, except that the increases allowed in Section 507 are not applicable
15 to waterfront structures.

16 **Exceptions:**

17 1. In covered boat moorages, the areas in Table 506.2 are permitted to be increased not more
18 than 400 percent when an approved automatic sprinkler system is provided throughout.

19 2. Each covered area of a boat moorage is permitted to be considered a separate building
20 subject to the following conditions:

21 2.1. Maximum individual areas shall be 8,000 square feet (743 m²). The maximum width
22 of connecting walkways shall be 10 feet (3048 mm).

1 2.2. Walkways, finger piers and other decked areas shall not exceed 30 percent of the area
2 of the roof that extends over water.

3 2.3. Covered areas shall be separated by not less than 16 feet (4877 mm). The intervening
4 areas are permitted to be used for moorage provided the adjacent covered areas
5 comply with Item 2.4 below.

6 2.4. Covered roof areas constructed in a manner that would trap smoke or hot gases shall
7 be provided with the following:

8 2.4.1 Vents or monitors of not less than 5 percent of the roof area.

9 2.4.2 A draft stop of splined or tongue-and-groove planking not less than 1 inch (25
10 mm) in thickness, 1/2-inch (13 mm) exterior-type plywood or 26 gauge steel
11 shall extend across the end of each roof area when the roof is closer than 30
12 feet (9144 mm) to an adjacent building. The draft stop shall extend to not less
13 than 24 inches (610 mm) below the lower edge of the roof. A draft stop
14 constructed in accordance with Section 427.6.2 shall be provided under the
15 walkway at each location where draft stops are required at the end of roofed
16 areas.

17 **427.4 Accessory uses.** Uses accessory to the principal occupancy shall be permitted, provided
18 they are conducted in an area separated from the moorage area by not less than 16 feet (4877
19 mm) and the exposed side of the moorage area is protected by a one-hour fire-resistance-rated
20 fire barrier extending 2-1/2 feet (762 mm) above the roof line. One-story superstructures shall be
21 permitted for accessory uses but shall not exceed 1,000 square feet (93 m²) in area nor 20 feet
22 (6096 mm) in height.

1 **Exception:** Storage is allowed in the moorage area, provided it conforms to the following:

2 1. One unprotected moorage equipment locker of not more than 150 cubic feet (115 m³) is
3 permitted for each slip.

4 2. Where groups of three or more lockers are provided, they shall be separated from each
5 other with one-hour fire-resistance-rated fire partitions, and openings in the separation
6 shall have one-hour protection.

7 3. Storage of flammable liquids shall be in accordance with NFPA 31 and the Fire Code.

8 **427.5 Location on property.** Exterior walls shall have fire resistance and opening protection as
9 determined by Section 705.

10 **Exceptions:**

11 1. Fire resistance-rated construction and opening protection required because of proximity to
12 property lines are permitted to be omitted for waterfront structures that are located on the
13 same property, separated by an unobstructed deck not less than 16 feet (4877 mm) wide,
14 and have a draft stop constructed according to Section 427.6.2 installed in the substructure
15 between the buildings.

16 2. In covered boat moorages, exterior walls that are built entirely over water are permitted to
17 be of tongue-and-groove or splined planks not less than 2 inches (51 mm) in thickness,
18 covered with 26 gauge sheet metal, 3/8-inch (9.5 mm) exterior type plywood or equivalent
19 on both sides, regardless of proximity to property lines. Walls at the substructure are
20 permitted to be constructed as specified in Section 427.6.2 for draft stops. Where such
21 walls (even though part of such covered boat moorage) are built on land, this exception
22 shall not apply.

427.6 Substructure.

427.6.1 Construction. Substructures are permitted to be of any type of construction permitted in this code subject to the area limitations of Section 427.3, except that, when constructed of wood, the members shall not be less than the following in any dimension, exclusive of piling:

| <u>Member</u> | <u>Size Unlimited Use × 25.4 for mm</u> | <u>Piers for Boat Moorage Only, Not Exceeding 10 feet (3048 mm) in Width × 25.4 for mm</u> |
|--|---|--|
| <u>Caps and girders</u> | <u>8"</u> | <u>6"</u> |
| <u>Joists, beams and other members</u> | <u>4"</u> | <u>3"</u> |
| <u>Flooring or deck</u> | <u>3" T & G or splined or 4" square edged</u> | <u>2"</u> |
| <u>Bracing</u> | <u>3"</u> | <u>2"</u> |
| <u>For SI: 1 inch = 25.4 mm</u> | | |

427.6.1.1 Flooring for covered piers. If the flooring or deck is under a roof or is used for parking, there shall be applied over the flooring or deck a tight-fitting wearing surface of softwood not less than 2 inches (51 mm) thick and not more than 6 inches (152 mm) wide, 1-inch (25 mm) thick hardwood, 2-inch (51 mm) thick asphaltic concrete or other material of equivalent fire resistance.

Exception: Covered piers used for moorage only need not have a wearing surface.

427.6.2 Draft stops. Draft stops shall be installed in all substructures constructed of combustible materials, exclusive of piling and pile bracing. They shall be placed not more than 100 feet (2540 mm) apart measured along the main axis of the pier or wharf. They shall fit tightly around all joists, beams, etc., and extend from the underside of the deck to city datum if over salt water or to low water if over fresh water. See Section 427.7.7 for draft stops in superstructures.

1 Substructure draft stops shall be constructed of at least two layers of lumber not less
2 than 2 inches (51 mm) in thickness laid with broken joints or materials of equal fire
3 resistance.

4 **427.7 Superstructure.**

5 427.7.1 Construction. Superstructures are permitted to be of any type of construction
6 permitted by this code subject to the height and area limitations of Section 427.3 and the
7 requirements of this section.

8 427.7.2 Floors. See Section 427.6.

9 427.7.3 Exterior walls. Exterior walls of Types IIA, IIB, III, IV and V buildings, when not
10 subject to the requirements of Section 427.5 because of their proximity to property lines, are
11 permitted to be constructed of matched or lapped lumber not less than 2 inches (51 mm) thick
12 and not more than 6 inches (153 mm) wide, or not less than 1 inch (25 mm) thick with a
13 weather covering of noncombustible material applied directly to the wood. Fireblocking is
14 an assembly having a three-fourths-hour fire- protection rating when fire-resistive openings
15 are required by Sections 705 and 1028.

16 427.7.4 Roof coverings. Roof coverings shall be fire-retardant as specified in Chapter 15.

17 427.7.5 Roof construction. In Type IV buildings the roof is permitted to be constructed of
18 corrugated galvanized steel attached directly to wood or steel purlins in lieu of that specified
19 in Section 602.4.

20 427.7.6 Fire-resistance-rated walls. In Types IIA, IIB, III, IV and V buildings, there shall
21 be at least one fire-resistance-rated wall from the deck to at least 3 feet (914 mm) above the
22 roof for each 500 feet (152 m) of length. Areas greater than 100,000 square feet (9290 m²)
23 shall be divided with such fire-resistance-rated walls. There shall be a draft stop constructed

1 as specified in Section 427.6.2, installed in the substructure immediately below every
2 required fire-resistance-rated wall when the deck is of combustible materials.

3 Fire-resistance-rated walls shall be constructed as required for two-hour fire-resistance-
4 rated walls or are permitted to consist of at least two layers of tongue-and-groove or splined
5 lumber, not less than 2 inches (51 mm) thick and not more than 6 inches (153 mm) wide,
6 with a sheet of not less than No. 26 gauge galvanized steel or 3/8-inch (3.2 mm) exterior type
7 plywood between the two layers, placed vertically with broken joints, or equivalent fire-
8 resistive construction.

9 Openings in fire-resistance-rated walls shall be protected by opening protectives having
10 a one and one-half hour fire protection rating.

11 **427.7.7 Draft stops.** Superstructure draft stops shall be installed as specified in Section 718.
12 Substructure draft stops constructed as specified in Section 427.6.2 shall be installed in line
13 with the superstructure draft stops above. See Section 427.12 for draft curtain requirements.

14 **427.7.8 Means of egress.** Means of egress shall be provided as specified in Chapter 10.

15 **Exceptions:**

- 16 1. Where two means of egress are required from an occupancy, they shall not
17 terminate on the same open deck.
- 18 2. An open deck is permitted to be considered an exit court and shall not be less than
19 10 feet (3048 mm) in width.
- 20 3. In Group A occupancies, the maximum travel distance shall not be more than 75
21 percent of that specified in Section 1017.
- 22 4. Boat moorages that have no sales, service or repair facilities are permitted to have a
23 single means of egress not less than 3 feet (914 mm) wide and shall be exempt from

1 the requirements of Section 1017 if a Class I standpipe is provided as specified in
2 Section 427.9.

3 **427.8 Width of piers.** Floats, piers and walkways shall provide an aisle not less than 3 feet 6
4 inches (1067 mm) in width for the purpose of fire department access.

5 **Exception:** Floats, piers and walkways that are less than 40 feet (12192 mm) in length and
6 that are not open to the public.

7 **427.9 Standpipe systems.** A manual Class I standpipe system (or Class III standpipe system
8 when approved by the fire code official) in accordance with NFPA Standard 14 shall be provided
9 for piers, wharves, and floats where the hose lay distance from the fire apparatus to the most
10 remote accessible portion of the pier, wharf or float exceeds 150 feet (45720 mm). Approved
11 plastic pipe may be used when installed underwater, or other approved method of protection
12 from fire is provided. The standpipe piping shall be a minimum of 4 inches (102 mm), sized to
13 provide a minimum of 500 gpm at 130 psi at the most remote hose connection, with a
14 simultaneous flow of 500 gpm at the third most remote hose connection on the same pier while
15 maintaining a maximum system pressure of 175 psi. Existing standpipe systems providing
16 equivalent performance to the specification listed above may be acceptable when approved by
17 the fire code official.

18 **427.9.1 Hose connections.** Hose connection stations on required standpipes shall be
19 provided at the water end of the pier, wharf, or float, and along the entire length of the pier,
20 wharf, or float at spacing not to exceed 150 feet (45720 mm) and as close as practical to the
21 land end.

1 **Exception:** The hose connection at the land end of the pier, wharf or float may be
2 omitted when a hose connection is located within 150 feet (45,720 mm) of the fire
3 apparatus access road.

4 Each hose connection shall consist of a valved 2-1/2-inch (64 mm) fire department hose
5 outlet. Outlet caps shall have a predrilled 1/8-inch (3.2 mm) hole for pressure relief and be
6 secured with a short length of chain or cable to prevent falling after removal. Listed
7 equipment shall be used.

8 **427.9.2 Hose stations.** Hose stations on required standpipes shall be provided at spacing not
9 to exceed 100 feet, with the first hose station located as close as practicable to the land end of
10 the pier. Each hose station shall have 100 feet of 1½-inch hose mounted on a reel or rack and
11 enclosed within an approved cabinet. A valved 2½-inch fire department hose outlet shall be
12 provided at each hose station. Outlet caps shall have a 1/8-inch predrilled hole for pressure
13 relief and be secured with a short length of chain or cable to prevent falling after removal.
14 Listed equipment shall be used. Hose stations shall be labeled FIRE HOSE-EMERGENCY
15 USE ONLY.

16 **427.9.3 Freeze protection.** Standpipe systems shall be maintained dry when subject to
17 freezing temperatures, and always from November 1 through March 31. The 1½-inch hose
18 stations shall be tagged out of service when the system is drained. The main water supply
19 control valve shall be readily accessible and clearly labeled so that the system may be
20 quickly restored to full service during periods when the system is drained down.

21 **Exception:** Other methods of freeze protection, such as listed freeze valves, are permitted
22 to be provided when approved by the fire code official.

1 **427.10 Automatic sprinklers.**

2 **427.10.1 Covered boat moorage.** Automatic sprinklers shall be provided for covered boat
3 moorage exceeding 500 square feet in projected roof area per pier, wharf or float.

4 The sprinkler system shall be designed and installed in accordance with NFPA 13 for
5 Extra Hazard Group 2 occupancy.

6 If sprinklers are required by this section, they shall be extended to any structure on the
7 pier, wharf or float exceeding 500 square feet in projected roof area.

8 **427.10.2 Substructure.** Automatic sprinklers shall be installed under the substructure of
9 every new waterfront structure in accordance with NFPA 307 and as specified in Chapter 9.

10 **Exception:** Sprinklers are not required in the following locations:

11 1. Combustible substructures whose deck area does not exceed 8,000 square feet (743.2
12 m²) supporting no superstructures.

13 2. Combustible substructures whose deck area does not exceed 8,000 square feet (743.2
14 m²) supporting superstructures not required to be provided with an approved automatic
15 sprinkler system as specified in Section 427.10.3.

16 3. Noncombustible substructures with or without superstructures.

17 4. Substructures, over other than tidal water, where sprinkler heads cannot be installed
18 with a minimum clearance of 4 feet (1219 mm) above mean high water.

19 5. Substructures resulting from walkways or finger piers that do not exceed 10 feet (3048
20 mm) in width.

21 **427.10.3 Superstructure.** Automatic sprinklers shall be provided in superstructures as
22 required by Chapter 9.

1 **427.10.4 Monitoring.** Sprinkler systems shall be monitored by an approved central station
2 service.

3 **427.11 Smoke and heat vents.** Approved automatic smoke and heat vents shall be provided in
4 covered boat moorage areas exceeding 2,500 square feet (232 m²) in area, excluding roof
5 overhangs.

6 **Exception:** Smoke and heat vents are not required in areas protected by automatic sprinklers.

7 **427.11.1 Design and installation.** Where smoke and heat vents are required they shall be
8 installed near the roof peak, evenly distributed and arranged so that at least one vent is over
9 each covered berth. The effective vent area shall be calculated using a ratio of one square
10 foot of vent to every fifteen square feet of covered berth area (1:15). Each vent shall provide
11 a minimum opening size of 4 feet by 4 feet.

12 **427.11.2 Automatic operation.** Smoke and heat vents shall operate automatically by
13 actuation of a heat-responsive device rated at between 100° F (56° C) and 220° F (122° C)
14 above ambient.

15 **Exception:** Gravity-operated drop out vents.

16 **427.11.3 Gravity-operated drop out vents.** Gravity operated dropout vents shall fully open
17 within five minutes after the vent cavity is exposed to a simulated fire represented by a time-
18 temperature gradient that reaches an air temperature of 500 F (260° C) within five minutes.

19 **427.12 Draft curtains.** Draft curtains shall be provided in covered boat moorage areas
20 exceeding 2,500 square feet (232 m²) in area, excluding roof overhangs.

21 **Exception:** Draft curtains are not required in areas protected by automatic sprinklers.

1 427.12.1 Draft curtain construction. Draft curtains shall be constructed of sheet metal,
2 gypsum board or other approved materials that provide equivalent performance to resist the
3 passage of smoke. Joints and connections shall be smoke tight.

4 427.12.2 Draft curtain location and depth. The maximum area protected by draft curtains
5 shall not exceed 2,000 square feet (186 m²) or two slips or berths, whichever is smaller. Draft
6 curtains shall not extend past the piling line. Draft curtains shall have a minimum depth of 2
7 feet (609 mm) below the lower edge of the roof and shall not extend closer than 8 feet (2438
8 mm) to the walking surface on the pier.

9 427.13 Fire department connections. Standpipe and sprinkler systems shall be equipped with
10 not less than a two-way 2½-inch fire department connection, which shall be readily visible and
11 located at the fire department apparatus access. The fire department connection for Class I
12 standpipe systems may be located at the shore end of the pier, wharf, or float if the distance
13 between the fire apparatus access road and fire department connection is less than 150 feet
14 (45720 mm). See Section 507 of the *International Fire Code* for requirements for fire hydrants.

15 427.14 Marina fire protection confidence testing. Standpipe and sprinkler systems shall be
16 inspected and tested in compliance with the *International Fire Code*.

17 427.15 Fire department access. Fire department apparatus access lanes, not less than 20 feet
18 wide and capable of supporting a 50,000-pound vehicle or 24,000 pounds per axle (HS20
19 loading), shall be provided and so located as to provide fire department apparatus access to
20 within 50 feet travel distance to the shore end of all piers, wharves and floats.

21 SECTION 428

22 PRIVATE AND UTILITY TRANSFORMER VAULTS

Note: Seattle City Light may have additional standards that supersede the requirements in this section.

1 **428.1 Scope.** Vaults housing private and utility transformers shall comply with the provisions of
2 this chapter and Article 450 of the *Seattle Electrical Code*. The provisions of this chapter are
3 minimum standards for all transformer vaults. Vaults containing utility transformers or
4 equipment are required to comply with additional requirements of Seattle City Light.

5 **428.2 Definitions.** The following terms are defined in Chapter 2:

6 **PRIVATE TRANSFORMER VAULT.**

7 **UTILITY TRANSFORMER VAULT.**

8 **428.3 When required.**

9 **428.3.1. Utility transformers.** Transformer vaults are required for all utility transformers
10 located inside a building. Seattle City Light shall approve the size, location, and layout of all
11 utility vaults.

12 **Exception:** Vaults are not required for certain dry-type transformers rated 600 volts or
13 less.

14 **428.3.2 Private transformers.** Transformer vaults are required for all oil-insulated private
15 transformers. Vaults are required for other private transformers rated over 35,000 volts that
16 are located inside a building.

17 **Exception:** Vaults are not required for certain oil-insulated private transformers in
18 accordance with Sections 450.26 and 450.27 of the *Seattle Electrical Code*.

19 **Note:** Article 450, Part II of the *Seattle Electrical Code* contains requirements for
20 transformers not required to be in a vault.

1 **428.4 Access to transformer vaults.**

2 **428.4.1 General access.** At least one door or hatch shall be provided in every vault. The
3 opening shall be adequate in size to permit the installation and removal of the equipment
4 located in the vault, and shall be kept unobstructed at all times. An unobstructed level area
5 shall be provided at the entrance to all vaults. The level area shall be large enough to allow
6 for movement of the transformer and equipment into and out of the vault.

7 **428.4.2 Utility transformer vault access.** Utility transformer vaults shall be accessible to
8 Seattle City Light personnel at all times. If it is necessary to pass through locked doors to
9 reach a vault, keys to those doors shall be kept in a key box that can be opened with the key
10 to the transformer vault. The key box shall be mounted near the first door requiring a non-
11 transformer door key. Persons other than Seattle City Light personnel shall not have access to
12 utility transformer vaults without Seattle City Light personnel present.

13 All doors between the vault and the building exterior shall be large enough to
14 accommodate the placement or removal of transformers. See Section 428.7 for doorway
15 requirements.

16 Utility transformer vaults shall be located so that there is an equipment access path
17 between the vault and the building exterior. The path shall comply with the following.

- 18 1. Sufficient horizontal and vertical clearance for the required transformer shall be
19 provided;
- 20 2. The floor shall be smooth, without seams or ridges to impede transportation of heavy
21 equipment;
- 22 3. There shall not be excessive slope as determined by Seattle City Light; and

1 4. The floor shall be designed to support the weight of the transformer and all equipment
2 needed to move the transformer.

3 If Seattle City Light determines that it is infeasible to design a path in the prescribed
4 manner, the building owner shall enter into a Transportation Agreement with Seattle City
5 Light. The Transportation Agreement obligates the building owner to transport equipment
6 between the right of way and the transformer vault whenever the Superintendent of Seattle
7 City Light determines it is necessary, and to pay all costs for equipment transportation.

Note: The Transportation Agreement is a measure of last-resort and permitted only with prior
Seattle City Light approval. A viable path for equipment transportation between the right-of-
way and the transformer vault should be a primary design consideration.

8 **428.5 Location of transformer vaults.** Transformer vaults shall be located where they can be
9 ventilated to the outside air without using flues or ducts wherever such an arrangement is
10 practicable. Transformer vaults shall be dry and not subject to running, standing or infiltration of
11 water.

12 Transformer vaults shall not be located where they are subject to flooding due to ground water
13 without specific written approval by Seattle City Light.

14 **428.6 Construction.**

15 **428.6.1 Private transformer vaults.** *Private transformer vaults* shall comply with the
16 following minimum requirements.

17 1. All *private transformer vaults* shall be of at least three-hour fire-resistive construction.

18 **Exception:** Subject to the approval of the building official, where the total capacity of
19 private oil-insulated transformers does not exceed 112-1/2 kVA, the vault is permitted to
20 be constructed of reinforced concrete not less than 4 inches (102 mm) thick.

1 2. Vault floors in contact with the earth shall be of concrete not less than 4 inches thick.

2 3. The transformer shall be anchored to inserts embedded in the concrete floor.

3 4. In pre-tensioned or post-tensioned concrete, cable locations shall be permanently
4 marked on the surface of the concrete over the encased tendons.

5 5. Vault dimensions shall be adequate for required ventilation and working clearances.

6 **428.6.2 Utility transformer vaults.** *Utility transformer vaults shall comply with the*
7 following minimum requirements. The Superintendent of Seattle City Light is authorized to
8 adjust the requirements of this Section 428.6.2 when deemed necessary.

9 1. Floors, walls and ceilings of utility transformer vaults shall have at least a three-hour
10 fire-resistance rating and shall be constructed of solid concrete or concrete-filled
11 concrete masonry units at least 6 inches (152 mm) thick.

12 2. Vault floors shall be smooth with no pads.

13 3. Seismic anchor inserts shall be embedded in the floor and steel support channels shall
14 be embedded in the ceiling when required by the Superintendent of Seattle City Light.

15 4. Pre-tensioned or post-tensioned concrete shall have the cable locations permanently
16 marked on the surface of the concrete over the encased tendons.

17 5. Vault dimensions shall depend upon physical size and number of secondary connection
18 devices, working clearances, and shall be approved by the Superintendent of Seattle
19 City Light.

20 **428.7 Openings into transformer vaults.** Transformer vault openings shall comply with this
21 section and Sections 705.8.2 and 705.8.3.

1 **428.7.1 Protection of openings.** All doorways opening into a transformer vault from the
2 building interior shall be protected by opening protectives having a fire-protection rating
3 equal to that required for the vault.

4 **428.7.2 Doorways.** All doors shall be made of three-hour fire-resistance-rated steel and shall
5 swing out of the vault 180 degrees. Doors that may be prevented from swinging 180 degrees
6 outward as a result of blockage by vehicles or mobile equipment shall be protected by
7 bollards. The bollards shall preserve the door swing area and shall not obstruct the doorway.
8 Equipment access doorways shall be sized to accommodate the transformer placement and
9 removal including the equipment necessary to place or remove the transformer.

10 Equipment access doorways to vaults containing only single-phase utility transformers
11 shall have clear openings no less than 42 inches (1067 mm) wide and 6 feet 8 inches (2057
12 mm) high. Equipment access doorways for all other utility transformers shall be sized to
13 accommodate the transformer placement and as specified by Seattle City Light to allow
14 equipment installation and removal.

15 Doorways for personnel access shall have clear openings of at least 36 inches (914 mm)
16 wide and 6 feet 8 inches (2057 mm) high.

17 **428.7.2.1 Locks.** All doors shall be equipped with locks and shall be kept locked. Doors to
18 utility transformer vaults shall be equipped with a cylinder capable of accepting the core
19 provided by the utility. Personnel doors shall be equipped with panic bars, pressure plates, or
20 other devices that are normally latched but open under simple pressure.

21 **428.7.2.2 Oil containment sill.** A removable oil containment sill shall be as high as
22 necessary to contain the oil of one transformer but in no case less than 4 inches (203 mm)

1 high or as specified by Seattle City Light for utility transformers. A sill shall be installed
2 within the vault at each doorway after the installation of the transformer.

3 **428.8 Ventilation systems for transformer vaults.**

4 **428.8.1 General.** Ventilation systems shall be provided to dispose of heat from transformer
5 total losses without creating a temperature rise that exceeds the transformer rating.

6 **428.8.2 Method of ventilation.** Ventilation shall be provided by either natural circulation or
7 mechanical circulation.

8 **428.8.2.1 Natural circulation.** Transformer vaults containing up to three transformers of
9 no more than 75 kVA each are permitted to be ventilated by natural circulation. The
10 combined minimum net intake and exhaust vent area, exclusive of area occupied by
11 screens, grating or louvers, shall not be less than 3 square inches (1935 mm²) per kVA of
12 transformer capacity. The total required area shall be divided roughly equally between
13 intake and exhaust. In no case shall either the intake or exhaust area be less than 72
14 square inches (46 452 mm²).

15 Approximately one half the total area required for ventilation openings shall be for
16 intake air. Intake air vents shall be located in one or more openings in the lower portion
17 of the perimeter vault walls. When the vault is located in a garage, any lower openings
18 must be at least 18 inches above the garage floor level. The remaining one half of the
19 required ventilation area shall be used to exhaust heat through one or more openings in
20 the upper portion of the perimeter walls or roof of the vault. Intake openings shall be
21 located on the opposite side of the vault from exhaust openings allowing air to flow
22 longitudinally over the transformer and out of the vault.

1 **428.8.2.2 Mechanical circulation.** Positive or negative pressure ventilation systems shall
2 supply a minimum of 1.6 cfm (.76 L/s) of air per kVA of transformer capacity. The fans
3 shall be installed outside of the vault and shall be controlled by a thermostat located
4 inside the vault.

5 The intake vents shall be located in the lower one half of the perimeter walls of the
6 vault. When the vault is located in a garage, any lower intake openings must be at least 18
7 inches above the garage floor level and at least 18 inches above the vault floor.

8 The exhaust vents shall be in the roof or ceiling of the vault. Vents are allowed to be
9 installed in a wall if the top of the vent is not less than 12 inches below the vault ceiling.
10 The top of the outlet on the exterior of the building shall be at least as high as the top of
11 the outlet from the vault.

12 The ventilation system shall cause air to flow longitudinally across the transformers.
13 The vault ventilation system shall be controlled independently from the rest of the
14 building ventilation.

15 For utility transformer vaults, mechanical ventilation systems shall be designed by the
16 applicant. The capacity and location of the ventilation system shall be approved by the
17 Superintendent of Seattle City Light.

18 **428.8.2.3 Temperature control.** A remote temperature controller shall be installed in
19 utility transformer vaults that have mechanical ventilation systems. The controller shall
20 activate the fan when the temperature in the vault exceeds 70° F (21°C), and shall turn the
21 fan off when the temperature reaches 140° F (60°C).

22 A visible or audible alarm shall be installed outside each utility transformer vault that
23 will be activated if the fan does not operate when the temperature controller calls for

1 ventilation, or if the fan becomes inoperable. A sign shall be mounted near the alarm
2 stating CALL SEATTLE CITY LIGHT WHEN ALARM SOUNDS or CALL SEATTLE
3 CITY LIGHT WHEN LIGHT IS ON.

4 **428.8.3 Ventilation openings and duct terminations.** Ventilation openings and duct
5 terminations shall comply with *International Mechanical Code* Section 501.3.1 item 7,
6 unless otherwise approved by the building official.

7 **428.8.3.1 Location of exhaust ventilation openings and exhaust duct terminations.**

8 Exhaust ventilation openings and duct terminations shall be located not less than 10 feet
9 (3048 mm) from fire escapes, required means of egress at the exterior of the building,
10 elements of the exit discharge, combustible exterior wall coverings, openings that are not
11 protected in accordance with Section 705.8, operable openings and property lines other
12 than a public way. Exhaust outlets shall be located on the exterior of the building.

13 **Interpretation I428.8:** For purposes of this section, “property line” includes any property
14 line separating one lot from another lot, but does not include any property line separating a
15 lot from a public street or alley right-of-way. The separation distance may be measured to
16 the opposite side of public streets and alleys.

17 **428.8.3.2 Covering.** Ventilation openings shall be covered with durable metal gratings,
18 screens or louvers. If operable intake louvers are provided on mechanically ventilated
19 transformer vaults, the louvers shall be controlled by the fan thermostat, i.e. the louvers
20 shall be opened when the fan is energized.

21 **428.8.3.3 Opening protection.** Intake ventilation openings in the vault walls on the
22 interior of the building shall be protected by automatic closing fire dampers having a fire-

1 protection rating at least equal to that required for the vault. The actuating device on the
2 fire damper shall be made to function at a temperature of 140°F (60°C).

3 **428.8.3.4 Ventilation ducts.** Exhaust ventilation ducts, if used, shall be enclosed in
4 construction having a fire-resistance rating at least equal to that required for the vault.

5 Exhaust ducts shall extend from the vault to the outside of the building. An exhaust duct
6 for a mechanically ventilated vault shall be used exclusively for ventilating the vault. No
7 fire dampers shall be installed in exhaust ventilation ducts.

8 **428.9 Drainage for vaults.**

9 **428.9.1 General.** Drains are prohibited in all transformer vaults.

10 **428.9.2 Sumps.** All transformer vaults containing oil-insulated transformers shall have a dry
11 sump. All sumps shall have an opening of at least 6 inches (152 mm) diameter, a depth of at
12 least 12 inches (305 mm), and shall be equipped with a removable steel grate that is flush
13 with the floor. Sumps shall have at least an 8 gallon (30 liter) capacity. Sump capacity may
14 be greater where required by the utility. The sump shall have a grouted bottom. The sump
15 shall be located near, but not directly behind, the personnel door and shall be out of the entry
16 path for moving transformers in and out of the vault. The vault floor shall slope at least 1
17 inch in 10 feet (25 mm in 305 mm) toward the sump.

18 **428.10 Pipes and ducts in transformer vaults.** No pipes or ducts foreign to the electrical
19 installation shall enter or pass through any transformer vault. Electrical conduits terminating at
20 transformer vaults shall be sealed with listed three-hour fire-protection rated firestop material.
21 Electrical conduits terminating at transformer vaults shall be installed to avoid channeling water
22 into the vault. Electrical conduits entering the vault floor shall be rigid galvanized steel and shall

1 extend no less than 18 inches (457 mm) into the vault or to the top of the containment sill,
2 whichever is greater.

3 **428.11 Storage in transformer vaults.** No material shall be stored in any transformer vault.

4 **428.12 Sprinkler systems.** Sprinkler systems shall not be installed within a transformer vault.

5 The vault must be maintained in a dry condition at all times.

6 **[F] SECTION 429**

7 **MEDICAL GAS SYSTEMS**

8 **429.1 General.** Medical gases at health care-related facilities intended for patient care, inhalation
9 or sedation, including but not limited to, analgesia systems for dentistry, podiatry, veterinary and
10 similar uses shall comply with Sections 429.2 through 429.3 in addition to other requirements of
11 this code and *International Fire Code* Chapter 53.

12 **429.2 Interior supply location.** Medical gases shall be stored in areas dedicated to the storage of
13 such gases without other storage or uses. Where containers of medical gases in quantities greater
14 than the permit amount are located inside buildings, they shall be in a 1-hour exterior room, a 1-
15 hour interior room or a gas cabinet in accordance with Section 429.2.1, 429.2.2 or 429.2.3,
16 respectively. Rooms or areas where medical gases are stored or used in quantities exceeding the
17 maximum allowable quantity per control area as set forth in *International Fire Code* Section
18 5003.1 shall comply with the requirements for Group H occupancies.

19 **429.2.1 One-hour exterior rooms.** A 1-hour exterior room shall be a room or enclosure
20 separated from the remainder of the building by *fire barriers* constructed in accordance with
21 Section 707 or *horizontal assemblies* constructed in accordance with Section 711, or both,
22 with a *fire-resistance rating* of not less than 1 hour. Openings between the room or enclosure
23 and interior spaces shall be self-closing smoke- and draft-control assemblies having a *fire*

1 protection rating of not less than 1 hour. Rooms shall have not less than one exterior wall
2 that is provided with not less than two nonclosable louvered vents. Each vent shall have a
3 minimum free opening area of 24 square inches (155 cm²) for each 1,000 cubic feet (28 m³)
4 at normal temperature and pressure (NTP) of gas stored in the room and shall be not less than
5 72 square inches (465 cm²) in aggregate free opening area. One vent shall be within 6 inches
6 (152 mm) of the floor and one shall be within 6 inches (152 mm) of the ceiling. Rooms shall
7 be provided with not less than one automatic sprinkler to provide container cooling in case of
8 fire.

9 **429.2.2 One-hour interior room.** Where an exterior wall cannot be provided for the room,
10 automatic sprinklers shall be installed within the room. The room shall be exhausted through
11 a duct to the exterior. Supply and exhaust ducts shall be enclosed in a 1-hour-rated shaft
12 enclosure from the room to the exterior. Approved mechanical ventilation shall comply with
13 the *International Mechanical Code* and be provided at a minimum rate of 1 cubic foot per
14 minute per square foot [0.00508 m³/(s • m²)] of the area of the room.

15 **429.2.3 Gas cabinets.** Gas cabinets shall be constructed in accordance with Section 5003.8.6
16 and the following:

- 17 1. The average velocity of ventilation at the face of access ports or windows shall be not
18 less than 200 feet per minute (1.02 m/s) with not less than 150 feet per minute (0.76
19 m/s) at any point of the access port or window.
- 20 2. They shall be connected to an exhaust system.
- 21 3. They shall be internally sprinklered.

1 **429.3 Exterior supply locations.** Oxidizer medical gas systems located on the exterior of a
2 building with quantities greater than the permit amount shall be located in accordance with
3 *International Fire Code Section 6304.2.1.*

4 Section 6. The following sections of Chapter 5 of the International Building Code, 2015
5 Edition, are amended as follows:

6 **CHAPTER 5**

7 **GENERAL BUILDING HEIGHTS AND AREAS**

8 **SECTION 501**

9 **GENERAL**

10 ***

11 **[F] 501.2 Address identification.** New and existing *buildings* shall be provided with *approved*
12 address identification. The address identification shall be legible and placed in a position that is
13 visible from the street or road fronting the property. Address identification characters shall
14 contrast with their background. Address numbers shall be Arabic numbers or alphabetical letters.
15 Numbers shall not be spelled out. Each character shall be a minimum of 4 inches (102 mm) high
16 with a minimum stroke width of 1/2 inch (12.7 mm). Where required by the *fire code official*,
17 address identification shall be provided in additional approved locations to facilitate emergency
18 response. Where access is by means of a private road and the building address cannot be viewed
19 from the public way, a monument, pole or other approved sign or means shall be used to identify
20 the structure. Address identification shall be maintained.

21 **501.2.1 Enforcement by building official.** The *building official* shall determine the address
22 of any property in the City in accordance with the numbering system established in this
23 Chapter.

1 Whenever the irregularity of plats, the changing direction of streets, avenues, or other
2 highways, the interruption of the continuity of highways or any other condition causes doubt
3 or difference of opinion as to the correct number of any piece of property or any building
4 thereon, the number shall be determined by the *building official*. The *building official* shall
5 be guided by the specific provisions of this chapter as far as they are applicable and when not
6 applicable, by such rules as are established to carry out the intent of this chapter.

7 **501.2.1.1 Owners to affix and maintain building numbers.** The owner of any *building*
8 or other structure shall maintain the street number of each *building* and structure in a
9 conspicuous place over or near the principal street entrance or entrances, or in other
10 conspicuous places as is necessary for the easy locating of such address.

11 **Exception:** Where there are multiple *buildings* on a site, the *building official* is
12 permitted to waive the requirement for posting an address on appurtenant or
13 accessory buildings where individual identification of each building is not
14 essential.

15 Where a property has frontage along more than one named street, or for any other
16 property, where there may be confusion regarding the address of a *building* or *structure*,
17 the *building official* is permitted to require the complete address, including street number
18 and street name to be conspicuously posted.

19 For *buildings* served by a private road or a common driveway, the address number(s)
20 shall be posted at the head of the road or driveway in a manner that can be easily read
21 from the intersecting street. Where the existing street grid may not adequately allow for
22 the assignment of street addresses that will promote the easy locating of such addresses,
23 or for any other reason consistent with the intent of this chapter, the *building official* is

1 permitted to assign a name to the private road or common driveway that shall be used for
2 addressing purposes. In addition, the *building official* is permitted to require one or more
3 property owners along the road or driveway to post a sign displaying the assigned name
4 at a location near the intersection of the road or driveway with a named public street.

5 If the *building official* finds that a *building*, structure or premises is not provided with
6 numbers as herein required, or is not correctly numbered, the *building official* is
7 permitted to notify the owner, agent or tenant of the correct street number and require that
8 the number be properly placed, in accordance with the provisions of this chapter, within a
9 reasonable length of time. It is a violation of this code for any person to fail to comply
10 with such notice.

11 **501.2.2 Numbering system prescribed.** The numerical designation of all doorways and
12 entrances to buildings and lots fronting upon the named right-of-ways of the City are
13 established in accordance with the following system:

14 Except where otherwise specified, 100 numbers are allotted to each block, provided that
15 where a named right-of-way intervenes between consecutively numbered right-of-ways, 50
16 numbers shall be allotted for each block. One whole number is allotted to each 20 feet (6096
17 mm) of frontage in each block; even numbers shall be used on the northerly side of named
18 right-of-ways extending in an easterly and westerly direction and on the easterly side of
19 named right-of-ways extending in a northerly and southerly direction. Odd numbers shall be
20 used on the southerly side of named right-of-ways extending in an easterly and westerly
21 direction and on the westerly side of named right-of-ways extending in a northerly and
22 southerly direction.

1 In the case of irregular named right-of-ways, the frontages shall be numbered as near as
2 may be according to the uniform series of block numbers with which they most nearly
3 correspond.

4 **501.2.3 Numbering of buildings**

5 **501.2.3.1 Numbering of buildings downtown.** Between Yesler Way and Denny Way
6 all frontages upon named right-of-ways extending in a northerly and southerly direction
7 and lying west of Broadway, East Union Street, Minor Avenue and Melrose Avenue shall
8 be numbered as follows:

9 Yesler Way to Fir Street number 100 and upwards, Fir Street to Spruce Street number
10 150 and upwards, Spruce Street to Alder Street number 200 and upwards, continuing by
11 consecutive hundreds to Pine Street; Pine Street to Olive Way number 1600 and upwards,
12 Olive Way to Howell Street number 1700 and upwards, Howell Street to Stewart Street
13 number 1800 and upwards, Stewart Street to Virginia Street number 1900 and upwards,
14 continuing by consecutive hundreds to Denny Way.

15 Between East Yesler Way and East Denny Way all frontages upon named right-of-ways
16 extending in a northerly and southerly direction and lying east of Broadway, East Union
17 Street, Minor Avenue and Melrose Avenue shall be numbered as follows:

18 East Yesler Way to East Fir Street number 100 and upwards, East Fir Street to East
19 Spruce Street number 150 and upwards, East Spruce Street to East Alder Street number
20 200 and upwards, continuing by consecutive hundreds to East Marion Street; East Marion
21 Street to East Spring Street number 900 and upwards, East Spring Street to East Union
22 Street number 1100 and upwards, East Union Street to East Pike Street number 1400 and
23 upwards, continuing by consecutive hundreds to East Denny Way.

1 Between East Yesler Way and East Denny Way all frontages upon named right-of-ways
2 extending in an easterly and westerly direction and lying west of Broadway, East Union
3 Street, Minor Avenue and Melrose Avenue shall be numbered as follows:

4 Southwesterly from Elliott Avenue, or Alaskan Way if south of Lenora Street, number
5 51 and downwards; Elliott Avenue (or Alaskan Way) to Western Avenue number 52 and
6 upwards; Western Avenue to First Avenue number 76 and upwards; First Avenue to
7 Second Avenue number 100 and upwards, continuing northeasterly to Broadway, East
8 Union Street, Minor Avenue, or Melrose Avenue by consecutive hundreds.

9 Between East Yesler Way and East Denny Way all frontages upon named right-of-ways
10 extending in an easterly and westerly direction and lying east of Broadway, East Union
11 Street, Minor Avenue and Melrose Avenue shall be numbered as follows:

12 Melrose Avenue to Bellevue Avenue number 300 and upwards, Bellevue Avenue to
13 Summit Avenue number 400 and upwards, continuing by consecutive hundreds to
14 Broadway.

15 Broadway to Tenth Avenue number 900 and upwards, Tenth Avenue to Eleventh
16 Avenue number 1000 and upwards, continuing by consecutive hundreds corresponding
17 with the numbered series of avenues eastward to Lake Washington.

18 On East Olive Way eastward from Melrose Avenue, the street numbers shall run
19 upwards consecutively, eastward from the existing street numbers that are west of the
20 Melrose Avenue intersection.

21 **501.2.3.2 Numbering of buildings south of downtown and east of the East**

22 **Waterway.** South of Yesler Way the frontages upon the named right-of-ways extending
23 in a northerly and southerly direction shall be numbered as follows:

1 Yesler Way (or East Yesler Way) to South Washington Street number 100 and upwards,
2 South Washington Street to South Main Street number 200 and upwards, South Main
3 Street to South Jackson Street number 300 and upwards, South Jackson Street to South
4 King Street number 400 and upwards, continuing by consecutive hundreds to South
5 Barton Place, with blocks and streets on Rainier Avenue South being taken as the
6 controlling series.

7 South of South Barton Place, 51st Avenue South shall be taken as the controlling series
8 to the southern City limits.

9 On Second Avenue Extension South from Fourth Avenue South to Yesler Way, the
10 frontages shall be numbered as follows:

11 From Fourth Avenue South to South Jackson Street number 100 and upwards, South
12 Jackson Street to South Main Street number 200 and upwards, South Main Street to
13 South Washington Street number 300 and upwards, South Washington Street to Yesler
14 Way number 400 and upwards.

15 South of Yesler Way the frontages upon named right-of-ways extending in an easterly
16 and westerly direction shall be numbered as follows:

17 Westward from First Avenue South to the Harbor Line or East Waterway number 99
18 and downwards, First Avenue South to Occidental Avenue South number 100 and
19 upwards, Occidental Avenue South to Second Avenue South number 150 and upwards,
20 Second Avenue South to Third Avenue South number 200 and upwards, continuing by
21 consecutive hundreds to Sixth Avenue South; Sixth Avenue South to Maynard Avenue
22 South number 600 and upwards, Maynard Avenue South to Seventh Avenue South
23 number 650 and upwards, Seventh Avenue South to Eighth Avenue South (or Airport

1 Way south of South Hinds Street) number 700 and upwards, Eighth Avenue South (or
2 Airport Way south of South Hinds Street) to Airport Way South (or Ninth Avenue South
3 of South Hinds Street) number 800 and upwards, Airport Way South (or Ninth Avenue
4 South of South Hinds Street) to Interstate Highway 5 number 900 and upwards,
5 continuing eastward by consecutive hundreds corresponding with the numbered series of
6 avenues to Lake Washington.

7 **501.2.3.3 Numbering of buildings between downtown and the Lake Washington**

8 **Ship Canal.** North of Denny Way, East Denny Way, and East Howell Street east of
9 Madrona Drive the frontages upon the named right-of-ways extending in a northerly and
10 southerly direction shall be numbered as follows:

11 Denny Way (and East or West Denny Way) to John Street (and East or West John
12 Street) number 100 and upwards, continuing by consecutive hundreds, the blocks and
13 streets on Queen Anne Avenue North being taken as a controlling series for numbering
14 purposes west of Fairview Avenue North (or Fairview Avenue East) and south of Bertona
15 Street (or West Bertona Street); 36th Avenue West being taken as the controlling series for
16 numbering purposes west of Fairview Ave North (or Fairview Ave East) and north of
17 Bertona Street (or West Bertona Street); Tenth Avenue East being taken as the controlling
18 series for numbering purposes east of Fairview Avenue North (or Fairview Avenue East).

19 Between Queen Anne Avenue North and Eastlake Avenue East (East Galer being the
20 northeast boundary of this subsection) the frontages on the named right-of-ways
21 extending in an easterly and westerly direction shall be numbered as follows:

22 Queen Anne Avenue North to First Avenue North number 1 and upwards, First Avenue
23 North to Warren Avenue North number 100 and upwards, Warren Avenue North to

1 Second Avenue North number 150 and upwards, Second Avenue North to Third Avenue
2 North number 200 and upwards, continuing by consecutive hundreds corresponding to
3 the numbered series of avenues with half hundreds in the case of Nob Hill, Taylor,
4 Bigelow, Mayfair, and Dexter Avenues North, to Ninth Avenue North; Ninth Avenue
5 North to Westlake Avenue North number 900 and upwards, Westlake Avenue North to
6 Terry Avenue North number 950 and upwards, Terry Avenue North to Boren Avenue
7 North number 1000 and upwards, Boren Avenue North to Fairview Avenue North number
8 1100 and upwards, Fairview Avenue North to Minor Avenue North number 1150 and
9 upwards, Minor Avenue North to Pontius Avenue North number 1200 and upwards,
10 Pontius Avenue North to Yale Avenue North number 1250 and upwards, Yale Avenue
11 North to Eastlake Avenue East number 1300 and upwards.

12 East of Eastlake Avenue East (or Fairview Avenue East north of East Galer Street) and
13 North of East Denny Way the frontages upon the named east-west right-of-ways
14 extending in an easterly and westerly direction shall be numbered as follows:

15 Eastlake Avenue East to Melrose Avenue East number 200 and upwards continuing by
16 consecutive hundreds eastward to Broadway East; Broadway East to Tenth Avenue East
17 number 900 and upwards, Tenth Avenue East to Federal Avenue East number 1000 and
18 upwards, Federal Avenue East to Eleventh Avenue East number 1050 and upwards,
19 Eleventh Avenue East to Twelfth Avenue East number 1100 and upwards, continuing by
20 consecutive hundreds eastward to Lake Washington.

21 West of Queen Anne Avenue North the frontages upon named east-west right-of-ways
22 extending in an easterly and westerly direction shall be numbered westward as follows:

1 Queen Anne Avenue North to First Avenue West number 1 and upwards, First Avenue
2 West to Second Avenue West number 100 and upwards, continuing by consecutive
3 hundreds westward.

4 **501.2.3.4 Numbering of buildings north of the Lake Washington Ship Canal.** The
5 plan for the numbering of frontages upon the various named right-of-ways in that portion
6 of the City of Seattle lying north of the Lake Washington Ship Canal is established as
7 follows:

8 The frontages upon the named right-of-ways extending in a northerly and southerly
9 direction shall be numbered in accordance with the designations of the intersecting
10 numbered streets as follows: northward from the State Harbor Line, number 2900 and
11 upwards.

12 The frontages upon the named right-of-ways extending in an easterly and westerly
13 direction shall be numbered as follows:

14 West from First Avenue Northwest, commencing with 100, and continuing west in
15 correspondence with the numbers of the avenues to Puget Sound.

16 East from First Avenue Northwest, commencing with 100 and continuing as follows:

17 East from Palatine Avenue North, 200 and upwards; from Greenwood Avenue North, 300
18 and upwards; from Phinney Avenue North, 400 and upwards; from Francis Avenue North,
19 450 and upwards; from Dayton Avenue North, 500 and upwards; from Evanston Avenue
20 North, 600 and upwards; from Fremont Avenue North, 700 and upwards; from North
21 Park Avenue North, 800 and upwards; from Linden Avenue North, 900 and upwards (800
22 and upwards south of North 65th Street); from Aurora Avenue North, 900 and upwards
23 (1100 and upwards north of North 65th Street); from Winslow Place North, 950 and

1 upwards; from Whitman Avenue North 1000 and upwards; from Albion Place North,
2 1050 and upwards; from Woodland Park Avenue North, 1100 and upwards; from Nesbit
3 Avenue North, 1150 and upwards; from Midvale Avenue North, 1200 and upwards; from
4 Lenora Place North, 1250 and upwards; from Stone Avenue North (Stone Way North
5 south of North 46th Street), 1300 and upwards; from Interlake Avenue North, 1400 and
6 upwards; from Ashworth Avenue North, 1500 and upwards; from Carr Place North, 1550
7 and upwards; from Woodlawn Avenue North, 1600 and upwards, from Densmore Avenue
8 North, 1700 and upwards; from Caroline Avenue North and Courtland Place North, 1750
9 and upwards; from Wallingford Avenue North, 1800 and upwards; from Burke Avenue
10 North and Canfield Place North, 1900 and upwards; From Stroud Avenue North and
11 Wayne Place North, 2000 and upwards; from Meridian Avenue North, 2100 and upwards;
12 from Bagley Avenue North, 2200 and upwards; from Corliss Avenue North, 2300 and
13 upwards; from Sunnyside Avenue North, 2400 and upwards; and from Eastern Avenue
14 North, 2500 and upwards.

15 East from First Avenue Northeast, commencing with 100, and continuing east in
16 correspondence with the numbered avenues to Lake Washington.

17 **501.2.3.5 Numbering buildings on Harbor Island.** The frontages upon named right-
18 of-ways extending in a northerly and southerly direction shall be numbered as follows:

19 Southwest Massachusetts Street to Southwest Florida Street, number 1700 and
20 upwards; Southwest Florida Street to Southwest Lander Street, number 2500 and
21 upwards; Southwest Lander Street to Southwest Hanford Street, number 2700 and
22 upwards; Southwest Hanford Street to Southwest Spokane Street, number 3200 and
23 upwards.

1 The frontages upon named right-of-ways extending in an easterly and westerly
2 direction shall be numbered as follows:

3 The East Waterway to 11th Avenue Southwest, number 900 and upwards; 11th Avenue
4 Southwest to 13th Avenue Southwest, number 1100 and upwards; 13th Avenue Southwest
5 to 16th Avenue Southwest, number 1300 and upwards; 16th Avenue Southwest to the West
6 Waterway, number 1600 and upwards.

7 **501.2.3.6 Numbering buildings west of the West Waterway and the Duwamish**

8 **Waterway.** The frontages upon named right-of-ways extending in a northerly and
9 southerly direction, shall be numbered as follows:

10 North of Southwest Andover Street, commencing with 3800 and continuing north to the
11 Duwamish Head by consecutive hundreds, the blocks and streets on California Avenue
12 Southwest being taken as the controlling series for numbering purposes.

13 South of Southwest Andover Street, commencing with 4000 and continuing south to
14 Southwest Roxbury Street by consecutive hundreds, the blocks and streets of California
15 Avenue Southwest being taken as the controlling series for numbering purposes.

16 South of Southwest Roxbury Street, commencing with 9600 and continuing south to the
17 south City limits by consecutive hundreds, in correspondence with the numbers of the
18 intersecting streets.

19 The frontages upon named right-of-ways extending in an easterly and westerly
20 direction, shall be numbered as follows:

21 West of California Avenue Southwest, commencing with 4300 and continuing
22 westward in correspondence with the numbers of the intersecting avenues to Puget
23 Sound.

1 East of California Avenue Southwest, commencing with 4200 and continuing eastward
2 in correspondence with the numbers of the intersecting avenues to the Duwamish
3 Waterway.

4 ***

5 SECTION 503

6 GENERAL BUILDING HEIGHT AND AREA LIMITATIONS

7 **503.1 General.** Unless otherwise specifically modified in Chapter 4 and this chapter, *building*
8 *height*, number of stories and *building area* shall not exceed the limits specified in Sections 504
9 and 506 based on the type of construction as determined by Section 602 and the occupancies as
10 determined by Section 302 except as modified hereafter. *Building height*, number of *stories* and
11 *building area* provisions shall be applied independently. Each portion of a *building* separated by
12 one or more *fire walls* complying with Section 706 shall be considered to be a separate *building*.

13 **Interpretation I503a:** An uncovered roof deck shall not be considered a story for the
14 purpose of determining the number of stories in a building.

15 ***

16 SECTION 504

17 BUILDING HEIGHT AND NUMBER OF STORIES

18 ***

19 **504.3 Height in feet.** The maximum height, in feet, of a *building* shall not exceed the limits
20 specified in Table 504.3.

21 **Exception:** Towers, spires, steeples and other rooftop structures shall be constructed of
22 materials consistent with the required type of construction of the *building* except where other
23 construction is permitted by Section 1510.2.5. Such structures shall not be used for habitation

1 or storage. The *structures* shall be unlimited in height where of noncombustible materials and
 2 shall not extend more than 20 feet (6096 mm) above the allowable building height where of
 3 combustible materials (see Chapter 15 for additional requirements).

TABLE 504.3^{a,1}
ALLOWABLE BUILDING HEIGHT IN FEET ABOVE GRADE PLANE
 TYPE OF CONSTRUCTION

| OCCUPANCY CLASSIFICATION | SEE FOOTNOTES | TYPE I | | TYPE II | | TYPE III | | TYPE IV | TYPE V | |
|--------------------------|---------------------|---------------------|-----------------|---------|-----|----------|----|---------|--------|----|
| | | A | B | A | B | A | B | HT | A | B |
| | | A, B, E, F, M, S, U | NS ^b | UL | 160 | 65 | 55 | 65 | 55 | 65 |
| | S | UL | 180 | 85 | 75 | 85 | 75 | 85 | 70 | 60 |
| H-1, H-2, H-3, H-5 | NS ^{c,d} | UL | 160 | 65 | 55 | 65 | 55 | 65 | 50 | 40 |
| | S | | | | | | | | | |
| H-4 | NS ^{c,d} | UL | 160 | 65 | 55 | 65 | 55 | 65 | 50 | 40 |
| | S | UL | 180 | 85 | 75 | 85 | 75 | 85 | 70 | 60 |
| I-1 Condition 1, I-3 | NS ^{d,e} | UL | 160 | 65 | 55 | 65 | 55 | 65 | 50 | 40 |
| | S | UL | 180 | 85 | 75 | 85 | 75 | 85 | 70 | 60 |
| I-1 Condition 2, I-2 | NS ^{d,f,e} | UL | 160 | 65 | 55 | 65 | 55 | 65 | 50 | 40 |
| | S | UL | 180 | 85 | | | | | | |
| I-4 | NS ^{d,g} | UL | 160 | 65 | 55 | 65 | 55 | 65 | 50 | 40 |
| | S | UL | 180 | 85 | 75 | 85 | 75 | 85 | 70 | 60 |
| R | NS ^{d,h} | UL | 160 | 65 | 55 | 65 | 55 | 65 | 50 | 40 |
| | S13R | 60 | 60 | 60 | 60 | 60 | 60 | 60 | 60 | 60 |
| | S | UL | 180 | 85 | 75 | 85 | 75 | 85 | 70 | 60 |

For SI: 1 foot = 304.8 mm.

Note: UL = Unlimited; NS = Buildings not equipped throughout with an automatic sprinkler system; S = Buildings equipped throughout with an automatic sprinkler system installed in accordance with Section 903.3.1.1; S13R = Buildings equipped throughout with an automatic sprinkler system installed in accordance with Section 903.3.1.2.

- a. See Chapters 4 and 5 for specific exceptions to the allowable height in this chapter.
- b. See Section 903.2 for the minimum thresholds for protection by an automatic sprinkler system for specific occupancies.
- c. New Group H occupancies are required to be protected by an automatic sprinkler system in accordance with Section 903.2.5.
- d. The NS value is only for use in evaluation of existing building height in accordance with the *International Existing Building Code*.
- e. New Group I-1 and I-3 occupancies are required to be protected by an automatic sprinkler system in accordance with Section 903.2.6. For new Group I-1 occupancies Condition 1, see Exception 1 of Section 903.2.6.
- f. New and existing Group I-2 occupancies are required to be protected by an automatic sprinkler system in accordance with Section 903.2.6 and Section 1103.5 of the *International Fire Code*.
- g. For new Group I-4 occupancies, see Exceptions 2 and 3 of Section 903.2.6.
- h. New Group R occupancies are required to be protected by an automatic sprinkler system in accordance with Section 903.2.8.
- i. A maximum of 12 inches of insulation may be added to the roof of an existing building without such additional height contributing to the building height.

4

TABLE 504.4a, b
ALLOWABLE NUMBER OF STORIES ABOVE GRADE PLANE

| OCCUPANCY CLASSIFICATION | TYPE OF CONSTRUCTION | | | | | | | | | |
|--------------------------|----------------------|--------|----|---------|----|----------|----|---------|--------|----|
| | SEE FOOTNOTES | TYPE I | | TYPE II | | TYPE III | | TYPE IV | TYPE V | |
| | | A | B | A | B | A | B | HT | A | B |
| A-1 | NS | UL | 5 | 3 | 2 | 3 | 2 | 3 | 2 | 1 |
| | S | UL | 6 | 4 | 3 | 4 | 3 | 4 | 3 | 2 |
| A-2 | NS | UL | 11 | 3 | 2 | 3 | 2 | 3 | 2 | 1 |
| | S | UL | 12 | 4 | 3 | 4 | 3 | 4 | 3 | 2 |
| A-3 | NS | UL | 11 | 3 | 2 | 3 | 2 | 3 | 2 | 1 |
| | S | UL | 12 | 4 | 3 | 4 | 3 | 4 | 3 | 2 |
| A-4 | NS | UL | 11 | 3 | 2 | 3 | 2 | 3 | 2 | 1 |
| | S | UL | 12 | 4 | 3 | 4 | 3 | 4 | 3 | 2 |
| A-5 | NS | UL | UL | UL | UL | UL | UL | UL | UL | UL |
| | S | UL | UL | UL | UL | UL | UL | UL | UL | UL |
| B | NS | UL | 11 | 5 | 3 | 5 | 3 | 5 | 3 | 2 |
| | S | UL | 12 | 6 | 4 | 6 | 4 | 6 | 4 | 3 |
| E | NS | UL | 5 | 3 | 2 | 3 | 2 | 3 | 1 | 1 |
| | S | UL | 6 | 4 | 3 | 4 | 3 | 4 | 2 | 2 |
| F-1 | NS | UL | 11 | 4 | 2 | 3 | 2 | 4 | 2 | 1 |
| | S | UL | 12 | 5 | 3 | 4 | 3 | 5 | 3 | 2 |
| F-2 | NS | UL | 11 | 5 | 3 | 4 | 3 | 5 | 3 | 2 |
| | S | UL | 12 | 6 | 4 | 5 | 4 | 6 | 4 | 3 |
| H-1 | NS ^{c, d} | 1 | 1 | 1 | 1 | 1 | 1 | 1 | 1 | NP |
| | S | | | | | | | | | |
| H-2 | NS ^{c, d} | UL | 3 | 2 | 1 | 2 | 1 | 2 | 1 | 1 |
| | S | | | | | | | | | |
| H-3 | NS ^{c, d} | UL | 6 | 4 | 2 | 4 | 2 | 4 | 2 | 1 |
| | S | | | | | | | | | |
| H-4 | NS ^{c, d} | UL | 7 | 5 | 3 | 5 | 3 | 5 | 3 | 2 |
| | S | UL | 8 | 6 | 4 | 6 | 4 | 6 | 4 | 3 |
| H-5 | NS ^{c, d} | 4 | 4 | 3 | 3 | 3 | 3 | 3 | 3 | 2 |
| | S | | | | | | | | | |
| I-1 Condition 1 | NS ^{d, e} | UL | 9 | 4 | 3 | 4 | 3 | 4 | 3 | 2 |
| | S | UL | 10 | 5 | 4 | 5 | 4 | 5 | 4 | 3 |
| I-1 Condition 2 | NS ^{d, e} | UL | 9 | 4 | 3 | 4 | 3 | 4 | 3 | 2 |

TABLE 504.4a, b
ALLOWABLE NUMBER OF STORIES ABOVE GRADE PLANE

| | S | UL | 10 | 5 | | | | | | | | | | | |
|------------------|-------------------|---------------|---------------|---|---|---|----|---|------------------|------------------|--------------|---|---|----------|---|
| I-2 | NSd, f | UL | 4 | 2 | 1 | 1 | NP | 1 | 1 | NP | | | | | |
| | S | UL | 5 | 3 | | | | | | | | | | | |
| I-3 | NSd, e | UL | 4 | 2 | 1 | 2 | 1 | 2 | 2 | 1 | | | | | |
| | S | UL | 5 | 3 | | | | | | | 2 | 3 | 2 | 3 | 3 |
| I-4 | NSd, g | UL | 5 | 3 | 2 | 3 | 2 | 3 | 1 | 1 | | | | | |
| | S | UL | 6 | 4 | | | | | | | 3 | 4 | 3 | 4 | 2 |
| M | NS | UL | 11 | 4 | 2 | 4 | 2 | 4 | 3 | 1 | | | | | |
| | S | UL | 12 | 5 | | | | | | | 3 | 5 | 3 | 5 | 4 |
| R-1 | NSd, h | UL | 11 | 4 | 4 | 4 | 4 | 4 | 4 | ((3)) | 2 | | | | |
| | | | | | | | | | | | | | | <u>4</u> | |
| | S13R | 4 | 4 | | | | | | | | | | | 4 | 3 |
| | S | UL | 12 | 5 | 5 | 5 | 5 | 5 | ((4)) | 3 | | | | | |
| | | | | | | | | | <u>5</u> | | | | | | |
| R-2 | NSd, h | UL | 11 | 4 | 4 | 4 | 4 | 4 | 4 | ((3)) | 2 | | | | |
| | | | | | | | | | | | | | | <u>4</u> | |
| | S13R | 4 | 4 | 4 | | | | | | | | | | 4 | 3 |
| | S | UL | 12 | 5 | 5 | 5 | 5 | 5 | ((4)) | 3 | | | | | |
| | | | | | | | | | <u>5</u> | | | | | | |
| R-3 | NSd, h | UL | 11 | 4 | 4 | 4 | 4 | 4 | 4 | ((3)) | 3 | | | | |
| | | | | | | | | | | | | | | <u>4</u> | |
| | S13R | 4 | 4 | | | | | | | | | | | 4 | 4 |
| | S | UL | 12 | 5 | 5 | 5 | 5 | 5 | ((4)) | 4 | | | | | |
| | | | | | | | | | <u>5</u> | | | | | | |
| ((R-4 | NSd, h | UL | 11 | 4 | 4 | 4 | 4 | 4 | 4 | 3 | 2 | | | | |
| | | | | | | | | | | | | | | 4 | 3 |
| | S13R | 4 | 4 | | | | | | | | | | | | |
| | S | UL | 12 | 5 | 5 | 5 | 5 | 5 | 4 | 3)) | | | | | |
| S-1 | NS | UL | 11 | 4 | 2 | 3 | 2 | 4 | 3 | 1 | | | | | |
| | S | UL | 12 | 5 | | | | | | | 3 | 4 | 3 | 5 | 4 |
| S-2 | NS | UL | 11 | 5 | 3 | 4 | 3 | 4 | 4 | 2 | | | | | |
| | S | UL | 12 | 6 | | | | | | | 4 | 5 | 4 | 5 | 5 |
| U | NS | UL | 5 | 4 | 2 | 3 | 2 | 4 | 2 | 1 | | | | | |
| | S | UL | 6 | 5 | | | | | | | 3 | 4 | 3 | 5 | 3 |

TABLE 504.4a, b
ALLOWABLE NUMBER OF STORIES ABOVE GRADE PLANE

Note: UL = Unlimited; NP = Not Permitted; NS = Buildings not equipped throughout with an automatic sprinkler system; S = Buildings equipped throughout with an automatic sprinkler system installed in accordance with Section 903.3.1.1; S13R = Buildings equipped throughout with an automatic sprinkler system installed in accordance with Section 903.3.1.2.

- a. See Chapters 4 and 5 for specific exceptions to the allowable height in this chapter.
- b. See Section 903.2 for the minimum thresholds for protection by an automatic sprinkler system for specific occupancies.
- c. New Group H occupancies are required to be protected by an automatic sprinkler system in accordance with Section 903.2.5.
- d. The NS value is only for use in evaluation of existing building height in accordance with the *International Existing Building Code*.
- e. New Group I-1 and I-3 occupancies are required to be protected by an automatic sprinkler system in accordance with Section 903.2.6. For new Group I-1 occupancies, Condition 1, see Exception 1 of Section 903.2.6.
- f. New and existing Group I-2 occupancies are required to be protected by an automatic sprinkler system in accordance with Section 903.2.6 and Section 1103.5 of the *International Fire Code*.
- g. For new Group I-4 occupancies, see Exceptions 2 and 3 of Section 903.2.6.
- h. New Group R occupancies are required to be protected by an automatic sprinkler system in accordance with Section 903.2.8.

SECTION 505

MEZZANINES AND EQUIPMENT PLATFORMS

505.1 General. *Mezzanines* shall comply with Section 505.2. *Equipment platforms* shall comply with Section 505.3.

Interpretation I505.1: *Mezzanines* within individual dwelling units shall not be located above other dwelling units or common space other than corridors.

505.2 Mezzanines. A *mezzanine* or *mezzanines* in compliance with Section 505.2 shall be considered a portion of the *story* below. Such *mezzanines* shall not contribute to either the *building area* or number of *stories* as regulated by Section 503.1. The area of the *mezzanine* shall be included in determining the *fire area*. The clear height above and below the *mezzanine* floor construction shall be not less than 7 feet (2134 mm).

1 **505.2.1 Area limitation.** The aggregate area of a *mezzanine* or *mezzanines* within a room
2 shall be not greater than (~~(one-third)~~) one-half of the floor area of that room or space in
3 which they are located. The enclosed portion of a room shall not be included in a
4 determination of the floor area of the room in which the *mezzanine* is located. In determining
5 the allowable *mezzanine* area, the area of the *mezzanine* shall not be included in the floor area
6 of the room.

7 (~~Where a room contains both a *mezzanine* and an *equipment platform*, the aggregate area~~
8 ~~of the two raised floor levels shall be not greater than two-thirds of the floor area of that~~
9 ~~room or space in which they are located.))~~

10 **Exception((s)):**

11 (~~(1.)~~) The aggregate area of *mezzanines* in *buildings* and *structures* of Type I or II
12 construction for special industrial occupancies in accordance with Section 503.1.1 shall
13 be not greater than two-thirds of the floor area of the room.

14 (~~(2. The aggregate area of *mezzanines* in buildings and structures of Type I or II~~
15 ~~construction shall be not greater than one-half of the floor area of the room in~~
16 ~~buildings and structures equipped throughout with an *approved automatic sprinkler*~~
17 ~~*system* in accordance with Section 903.3.1.1 and an *approved emergency voice/alarm*~~
18 ~~*communication system* in accordance with Section 907.5.2.2.))~~

19 **Interpretation I505.2:** Only the following unenclosed areas of the room or space
20 containing the *mezzanine* shall be used for purposes of calculating the allowable *mezzanine*
21 floor area:

- 22 1. Areas with a ceiling height of at least 7 feet located directly below the *mezzanine*,
23 except that no additional area benefit shall be gained for stacked *mezzanines*, and;

2. Areas where the ceiling has a slope of less than 2:12 and with a ceiling height of at least 14 feet plus the thickness of the *mezzanine* floor construction, and;

3. Areas where the ceiling has a slope of 2:12 or more and has a ceiling height of at least 12 feet plus the thickness of the *mezzanine* floor construction, provided that the *mezzanine* complies with Section 1208.2, exception 2.

Within a dwelling unit, enclosed or unenclosed portions of the entire floor level containing the *mezzanine* that meet requirements of this interpretation for the room area may be used for purposes of calculating the allowable *mezzanine* floor area.

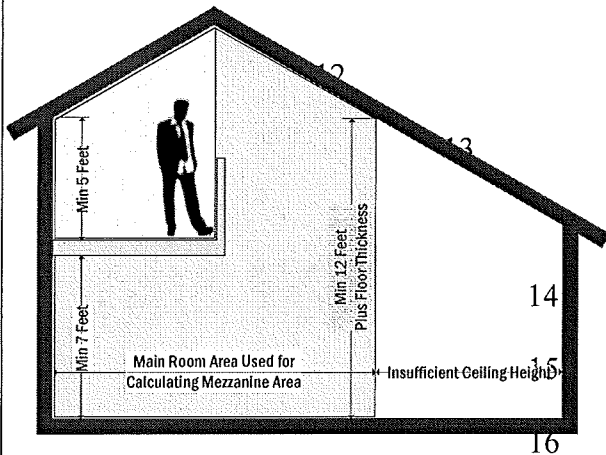

Basis for Calculating Allowable Mezzanine Area
When Using Sloped Ceiling Provisions

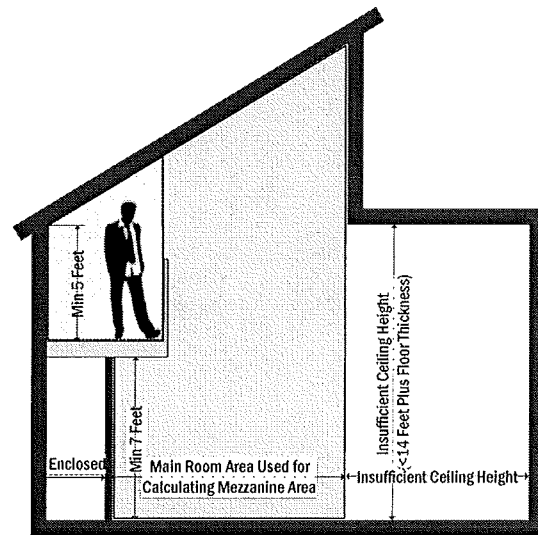

Basis for Calculating Allowable Mezzanine Area
With Other Conditions

505.2.1.1 Area limitation of mezzanines and equipment platforms. Where a room contains both a mezzanine and an equipment platform, the aggregate area of the two raised floor levels shall be not greater than two-thirds of the floor area of that room or space in which they are located. The area of the mezzanine shall not exceed the area determined according to Section 505.2.1.

1 **505.2.2 Means of egress.** The *means of egress* for *mezzanines* shall comply with the
2 applicable provisions of Chapter 10.

3 **505.2.3 Openness.** A *mezzanine* shall be open and unobstructed to the room in which such
4 *mezzanine* is located except for walls not more than 42 inches (1067 mm) in height, columns
5 and posts.

6 **Exceptions:**

- 7 1. *Mezzanines* or portions thereof are not required to be open to the room in which the
8 *mezzanines* are located, provided that the *occupant load* of the aggregate area of
9 the enclosed space is not greater than 10.
- 10 2. A *mezzanine* having two or more exits or access to exits is not required to be open
11 to the room in which the *mezzanine* is located.
- 12 3. *Mezzanines* or portions thereof are not required to be open to the room in which the
13 *mezzanines* are located, provided that the aggregate floor area of the enclosed
14 space is not greater than 10 percent of the allowable *mezzanine* area.
- 15 4. In industrial facilities, *mezzanines* used for control equipment are permitted to be
16 glazed on all sides.
- 17 5. In occupancies other than Groups H and I, that are no more than two *stories above*
18 *grade plane* and equipped throughout with an *automatic sprinkler system* in
19 accordance with Section 903.3.1.1, a *mezzanine* having two or more *means of*
20 *egress* shall not be required to be open to the room in which the *mezzanine* is
21 located.

22 **505.2.4 Construction.** *Mezzanines* and building elements supporting only the *mezzanine*
23 shall comply with the fire-resistance ratings for floor construction in Table 601.

1 **505.3 Equipment platforms.** Equipment platforms and building elements supporting only the
2 platform shall be built of materials permitted for the type of construction of the building.

3 Equipment platforms in building shall not:

4 1. Be considered as a portion of the floor below.

5 2. Contribute to either the *building area* or the number of *stories* as regulated by Section

6 503.1.

7 3. Be included in determining the *fire area* in accordance with Section 903.

8 4. Be a part of any *mezzanine*.

9 5. Serve as a part of the *means of egress* from the building, including the walkways,

10 *stairs, alternating tread devices* and ladders providing access to an equipment platform.

11 ~~((*Equipment platforms* in buildings shall not be considered as a portion of the floor below. Such~~

12 ~~*equipment platforms* shall not contribute to either the *building area* or the number of *stories* as~~

13 ~~regulated by Section 503.1. The area of the *equipment platform* shall not be included in~~

14 ~~determining the *fire area* in accordance with Section 903. *Equipment platforms* shall not be a~~

15 ~~part of any *mezzanine* and such platforms and the walkways, stairways, *alternating tread devices*~~

16 ~~and ladders providing access to an *equipment platform* shall not serve as a part of the *means of*~~

17 ~~*egress* from the building.))~~

18 **505.3.1 Area limitation.** The aggregate area of all *equipment platforms* within a room shall

19 be not greater than two-thirds of the area of the room in which they are located. Where an

20 *equipment platform* is located in the same room as a *mezzanine*, the area of the *mezzanine*

21 shall be determined by Section 505.2.1 and the combined aggregate area of the *equipment*

22 *platforms* and *mezzanines* shall be not greater than two-thirds of the room in which they are

located. The area of the mezzanine shall not exceed the area determined according to Section 505.2.1.

505.3.2 Automatic sprinkler system. Where located in a building that is required to be protected by an *automatic sprinkler system*, *equipment platforms* shall be fully protected by sprinklers above and below the platform, where required by the standards referenced in Section 903.3.

505.3.3 Guards. *Equipment platforms* shall have *guards* where required by Section 1015.2.

SECTION 506

BUILDING AREA

506.1 General. The allowable floor area of a *building* shall be determined based on the type of construction, occupancy classification, whether there is an *automatic sprinkler system* installed throughout the building and the amount of building frontage on public way or open space.

TABLE 506.2a, b
ALLOWABLE AREA FACTOR ($A_t = NS, S1, S13R, \text{ or } SM, \text{ as applicable}$) IN SQUARE FEET

| OCCU PANC Y CLAS SIFIC ATIO N | SEE FOOTN OTES | TYPE OF CONSTRUCTION | | | | | | | | |
|---|----------------------|----------------------|----|---------|--------|---------|--------|---------|--------|--------|
| | | TYPE I | | TYPE II | | TYPE II | | TYPE IV | TYPE V | |
| | | A | B | A | B | A | B | HT | A | B |
| A-1 | NS | UL | UL | 15,500 | 8,500 | 14,000 | 8,500 | 15,000 | 11,500 | 5,500 |
| | S1 | UL | UL | 62,000 | 34,000 | 56,000 | 34,000 | 60,000 | 46,000 | 22,000 |
| | SM | UL | UL | 46,500 | 25,500 | 42,000 | 25,500 | 45,000 | 34,500 | 16,500 |
| A-2 | NS | UL | UL | 15,500 | 9,500 | 14,000 | 9,500 | 15,000 | 11,500 | 6,000 |
| | S1 | UL | UL | 62,000 | 38,000 | 56,000 | 38,000 | 60,000 | 46,000 | 24,000 |
| | SM | UL | UL | 46,500 | 28,500 | 42,000 | 28,500 | 45,000 | 34,500 | 18,000 |
| A-3 | NS | UL | UL | 15,500 | 9,500 | 14,000 | 9,500 | 15,000 | 11,500 | 6,000 |
| | S1 | UL | UL | 62,000 | 38,000 | 56,000 | 38,000 | 60,000 | 46,000 | 24,000 |
| | SM | UL | UL | 46,500 | 28,500 | 42,000 | 28,500 | 45,000 | 34,500 | 18,000 |
| A-4 | NS | UL | UL | 15,500 | 9,500 | 14,000 | 9,500 | 15,000 | 11,500 | 6,000 |
| | S1 | UL | UL | 62,000 | 38,000 | 56,000 | 38,000 | 60,000 | 46,000 | 24,000 |
| | SM | UL | UL | 46,500 | 28,500 | 42,000 | 28,500 | 45,000 | 34,500 | 18,000 |
| A-5 | NS | UL | UL | UL | UL | UL | UL | UL | UL | UL |
| | S1 | | | | | | | | | |
| | SM | | | | | | | | | |
| | NS | UL | UL | 37,500 | 23,000 | 28,500 | 19,000 | 36,000 | 18,000 | 9,000 |

| | | | | | | | | | | |
|-----|-------------------|--------|---------|---------|--------|---------|--------|---------|--------|--------|
| B | S1 | UL | UL | 150,000 | 92,000 | 114,000 | 76,000 | 144,000 | 72,000 | 36,000 |
| | SM | UL | UL | 112,500 | 69,000 | 85,500 | 57,000 | 108,000 | 54,000 | 27,000 |
| E | NS | UL | UL | 26,500 | 14,500 | 23,500 | 14,500 | 25,500 | 18,500 | 9,500 |
| | S1 | UL | UL | 106,000 | 58,000 | 94,000 | 58,000 | 102,000 | 74,000 | 38,000 |
| | SM | UL | UL | 79,500 | 43,500 | 70,500 | 43,500 | 76,500 | 55,500 | 28,500 |
| F-1 | NS | UL | UL | 25,000 | 15,500 | 19,000 | 12,000 | 33,500 | 14,000 | 8,500 |
| | S1 | UL | UL | 100,000 | 62,000 | 76,000 | 48,000 | 134,000 | 56,000 | 34,000 |
| | SM | UL | UL | 75,000 | 46,500 | 57,000 | 36,000 | 100,500 | 42,000 | 25,500 |
| F-2 | NS | UL | UL | 37,500 | 23,000 | 28,500 | 18,000 | 50,500 | 21,000 | 13,000 |
| | S1 | UL | UL | 150,000 | 92,000 | 114,000 | 72,000 | 202,000 | 84,000 | 52,000 |
| | SM | UL | UL | 112,500 | 69,000 | 85,500 | 54,000 | 151,500 | 63,000 | 39,000 |
| H-1 | NS ^c | 21,000 | 16,500 | 11,000 | 7,000 | 9,500 | 7,000 | 10,500 | 7,500 | NP |
| | S1 | | | | | | | | | |
| H-2 | NS ^c | 21,000 | 16,500 | 11,000 | 7,000 | 9,500 | 7,000 | 10,500 | 7,500 | 3,000 |
| | S1 | | | | | | | | | |
| | SM | | | | | | | | | |
| H-3 | NS ^c | UL | 60,000 | 26,500 | 14,000 | 17,500 | 13,000 | 25,500 | 10,000 | 5,000 |
| | S1 | | | | | | | | | |
| | SM | | | | | | | | | |
| H-4 | NS ^{c,d} | UL | UL | 37,500 | 17,500 | 28,500 | 17,500 | 36,000 | 18,000 | 6,500 |
| | S1 | UL | UL | 150,000 | 70,000 | 114,000 | 70,000 | 144,000 | 72,000 | 26,000 |
| | SM | UL | UL | 112,500 | 52,500 | 85,500 | 52,500 | 108,000 | 54,000 | 19,500 |
| H-5 | NS ^{c,d} | UL | UL | 37,500 | 23,000 | 28,500 | 19,000 | 36,000 | 18,000 | 9,000 |
| | S1 | UL | UL | 150,000 | 92,000 | 114,000 | 76,000 | 144,000 | 72,000 | 36,000 |
| | SM | UL | UL | 112,500 | 69,000 | 85,500 | 57,000 | 108,000 | 54,000 | 27,000 |
| I-1 | NS ^{d,e} | UL | 55,000 | 19,000 | 10,000 | 16,500 | 10,000 | 18,000 | 10,500 | 4,500 |
| | S1 | UL | 220,000 | 76,000 | 40,000 | 66,000 | 40,000 | 72,000 | 42,000 | 18,000 |
| | SM | UL | 165,000 | 57,000 | 30,000 | 49,500 | 30,000 | 54,000 | 31,500 | 13,500 |
| I-2 | NS ^{d,f} | UL | UL | 15,000 | 11,000 | 12,000 | NP | 12,000 | 9,500 | NP |
| | S1 | UL | UL | 60,000 | 44,000 | 48,000 | NP | 48,000 | 38,000 | NP |
| | SM | UL | UL | 45,000 | 33,000 | 36,000 | NP | 36,000 | 28,500 | NP |
| I-3 | NS ^{d,e} | UL | UL | 15,000 | 10,000 | 10,500 | 7,500 | 12,000 | 7,500 | 5,000 |
| | S1 | UL | UL | 45,000 | 40,000 | 42,000 | 30,000 | 48,000 | 30,000 | 20,000 |
| | SM | UL | UL | 45,000 | 30,000 | 31,500 | 22,500 | 36,000 | 22,500 | 15,000 |
| I-4 | NS ^{d,g} | UL | 60,500 | 26,500 | 13,000 | 23,500 | 13,000 | 25,500 | 18,500 | 9,000 |
| | S1 | UL | 121,000 | 106,000 | 52,000 | 94,000 | 52,000 | 102,000 | 74,000 | 36,000 |
| | SM | UL | 181,500 | 79,500 | 39,000 | 70,500 | 39,000 | 76,500 | 55,500 | 27,000 |
| M | NS | UL | UL | 21,500 | 12,500 | 18,500 | 12,500 | 20,500 | 14,000 | 9,000 |
| | S1 | UL | UL | 86,000 | 50,000 | 74,000 | 50,000 | 82,000 | 56,000 | 36,000 |
| | SM | UL | UL | 64,500 | 37,500 | 55,500 | 37,500 | 61,500 | 42,000 | 27,000 |
| R-1 | NS ^{d,h} | UL | UL | 24,000 | 16,000 | 24,000 | 16,000 | 20,500 | 12,000 | 7,000 |
| | S13R | | | | | | | | | |
| | S1 | UL | UL | 96,000 | 64,000 | 96,000 | 64,000 | 82,000 | 48,000 | 28,000 |
| R-2 | SM | UL | UL | 72,000 | 48,000 | 72,000 | 48,000 | 61,500 | 36,000 | 21,000 |
| | NS ^{d,h} | UL | UL | 24,000 | 16,000 | 24,000 | 16,000 | 20,500 | 12,000 | 7,000 |
| | S13R | | | | | | | | | |
| | S1 | UL | UL | 96,000 | 64,000 | 96,000 | 64,000 | 82,000 | 48,000 | 28,000 |
| | SM | UL | UL | 72,000 | 48,000 | 72,000 | 48,000 | 61,500 | 36,000 | 21,000 |
| | NS ^{d,h} | UL | UL | UL | UL | UL | UL | UL | UL | UL |

| | | | | | | | | | | |
|-------|-------------------|----|---------|---------|---------|---------|---------|---------|--------|--------|
| R-3 | S13R | | | | | | | | | |
| | S1 | | | | | | | | | |
| | SM | | | | | | | | | |
| ((R-4 | NS ^{d,h} | UL | UL | 24,000 | 16,000 | 24,000 | 16,000 | 20,500 | 12,000 | 7,000 |
| | S13R | | | | | | | | | |
| | S1 | UL | UL | 96,000 | 64,000 | 96,000 | 64,000 | 82,000 | 48,000 | 28,000 |
| | SM | UL | UL | 72,000 | 48,000 | 72,000 | 48,000 | 61,500 | 36,000 | 21,000 |
| S-1 | NS | UL | 48,000 | 26,000 | 17,500 | 26,000 | 17,500 | 25,500 | 14,000 | 9,000 |
| | S1 | UL | 192,000 | 104,000 | 70,000 | 104,000 | 70,000 | 102,000 | 56,000 | 36,000 |
| | SM | UL | 144,000 | 78,000 | 52,500 | 78,000 | 52,500 | 76,500 | 42,000 | 27,000 |
| S-2 | NS | UL | 79,000 | 39,000 | 26,000 | 39,000 | 26,000 | 38,500 | 21,000 | 13,500 |
| | S1 | UL | 316,000 | 156,000 | 104,000 | 156,000 | 104,000 | 154,000 | 84,000 | 54,000 |
| | SM | UL | 237,000 | 117,000 | 78,000 | 117,000 | 78,000 | 115,500 | 63,000 | 40,500 |
| U | NS | UL | 35,500 | 19,000 | 8,500 | 14,000 | 8,500 | 18,000 | 9,000 | 5,500 |
| | S1 | UL | 142,000 | 76,000 | 34,000 | 56,000 | 34,000 | 72,000 | 36,000 | 22,000 |
| | SM | UL | 106,500 | 57,000 | 25,500 | 42,000 | 25,500 | 54,000 | 27,000 | 16,500 |

Note: UL = Unlimited; NP = Not permitted;

For SI: 1 square foot=0.0929 m².

NS = Buildings not equipped throughout with an automatic sprinkler system; S1 = Buildings a maximum of one story above grade plane equipped throughout with an automatic sprinkler system installed in accordance with Section 903.3.1.1; SM = Buildings two or more stories above grade plane equipped throughout with an automatic sprinkler system installed in accordance with Section 903.3.1.1; S13R = Buildings equipped throughout with an automatic sprinkler system installed in accordance with Section 903.3.1.2.

- a. See Chapters 4 and 5 for specific exceptions to the allowable height in this chapter.
- b. See Section 903.2 for the minimum thresholds for protection by an automatic sprinkler system for specific occupancies.
- c. New Group H occupancies are required to be protected by an automatic sprinkler system in accordance with Section 903.2.5.
- d. The NS value is only for use in evaluation of existing building area in accordance with the *International Existing Building Code*.
- e. New Group I-1 and I-3 occupancies are required to be protected by an automatic sprinkler system in accordance with Section 903.2.6. For new Group I-1 occupancies, Condition 1, see Exception 1 of Section 903.2.6.
- f. New and existing Group I-2 occupancies are required to be protected by an automatic sprinkler system in accordance with Section 903.2.6 and Section 1103.5 of the *International Fire Code*.
- g. New Group I-4 occupancies see Exceptions 2 and 3 of Section 903.2.6.
- h. New Group R occupancies are required to be protected by an automatic sprinkler system in accordance with Section 903.2.8.

506.2.3 Single-occupancy, multistory buildings. The allowable area of a single-occupancy building with more than one story above grade plane shall be determined in accordance with Equation 5-2:

1 $Aa = [At + (NS \times If)] \times Sa$ (Equation 5-2)

2 where:

3 Aa = Allowable area (square feet).

4 At = Tabular allowable area factor (NS, S13R or SM value, as applicable) in accordance with
5 Table 506.2.

6 NS = Tabular allowable area factor in accordance with Table 506.2 for a nonsprinklered
7 building (regardless of whether the building is sprinklered).

8 If = Area factor increase due to frontage (percent) as calculated in accordance with Section
9 506.3.

10 Sa = Actual number of building *stories above grade plane*, not to exceed three. For buildings
11 equipped throughout with an *automatic sprinkler system* installed in accordance with
12 Section 903.3.1.2, use the actual number of building *stories above grade plane*, not to
13 exceed four.

14 No individual story shall exceed the allowable area (Aa) as determined by Equation 5-2 using
15 the value of $Sa = 1$.

16 **Note:** NFPA 13R sprinkler systems are limited to buildings of Group R up to and including
17 four stories in height. See Section 903.3.1.2.

18 ***

19 **SECTION 508**

20 **MIXED USE AND OCCUPANCY**

21 **508.1 General.** Each portion of a *building* shall be individually classified in accordance with
22 Section 302.1. Where a *building* contains more than one occupancy group, the building or

1 portion thereof shall comply with the applicable provisions of Section 508.2, 508.3 or 508.4, or a
2 combination of these sections.

3 **Exceptions:**

- 4 1. Occupancies separated in accordance with Section 510.
- 5 2. Where required by Table 415.6.2, areas of Group H-1, H-2 and H-3 occupancies shall
6 be located in a *detached building* or structure.
- 7 3. Uses within *live/work units*, complying with Section 419, are not considered separate
8 occupancies.

9 **[W]** 4. Offices, mercantile, food preparation establishments for off-site consumption,
10 personal care salons or similar uses in Group R dwelling units, which are conducted
11 primarily by the occupants of a *dwelling unit* and are secondary to the use of the unit
12 for dwelling purposes, and which do not exceed 500 square feet (46.4 m²) are not
13 considered a separate occupancy.

14 **508.2 Accessory occupancies.** Accessory occupancies are those occupancies that are ancillary to
15 the main occupancy of the *building* or portion thereof. Accessory occupancies shall comply with
16 the provisions of Sections 508.2.1 through 508.2.4.

17 **508.2.1 Occupancy classification.** Accessory occupancies shall be individually classified in
18 accordance with Section 302.1. The requirements of this code shall apply to each portion of
19 the *building* based on the occupancy classification of that space.

20 **508.2.2 Allowable building height.** The allowable height and number of stories of the
21 *building* containing accessory occupancies shall be in accordance with Section 504 for the
22 main occupancy of the *building*.

1 **508.2.3 Allowable building area.** The allowable area of the *building* shall be based on the
2 applicable provisions of Section 506 for the main occupancy of the *building*. Aggregate
3 accessory occupancies shall not occupy more than 10 percent of the floor area of the *story* in
4 which they are located and shall not exceed the tabular values for nonsprinklered *buildings* in
5 Table 506.2 for each such accessory occupancy.

6 **508.2.4 Separation of accessory occupancies.** No separation is required between accessory
7 occupancies and the main occupancy.

8 **Exceptions:**

- 9 1. Group H-2, H-3, H-4 and H-5 occupancies shall be separated from all other
10 occupancies in accordance with Section 508.4.
- 11 2. Group I-1, R-1, R-2 and R-3 *dwelling units* and *sleeping units* shall be separated
12 from other *dwelling* or *sleeping units* and from accessory occupancies contiguous
13 to them in accordance with the requirements of Section 420.

14 ***

15 **508.3 Nonseparated occupancies.** *Buildings* or portions of *buildings* that comply with the
16 provisions of this section shall be considered as nonseparated occupancies.

17 **508.3.1 Occupancy classification.** Nonseparated occupancies shall be individually classified
18 in accordance with Section 302.1. The requirements of this code shall apply to each portion
19 of the *building* based on the occupancy classification of that space. In addition, the most
20 restrictive provisions of Chapter 9 that apply to the nonseparated occupancies shall apply to
21 the total nonseparated occupancy area. Where nonseparated occupancies occur in a *high-rise*
22 *building*, the most restrictive requirements of Section 403 that apply to the nonseparated
23 occupancies shall apply throughout the *high-rise building*.

1 **508.3.2 Allowable building area and height.** The allowable *building area*, number of stories
2 and *height* of the building or portion thereof shall be based on the most restrictive allowances
3 for the occupancy groups under consideration for the type of construction of the building in
4 accordance with Section 503.1.

5 ***

6 **508.4 Separated occupancies.** Buildings or portions of buildings that comply with the
7 provisions of this section shall be considered as separated occupancies.

8 **Exceptions:**

9 1. No separation is required between Group A-2 or A-3 and Groups B or M occupancies
10 when both are protected by an *automatic sprinkler system*.

11 2. Subject to the approval of the *building official*, unprotected openings are permitted in
12 separations between parking areas and enclosed portions of buildings such as entry
13 lobbies and similar areas provided:

14 2.1. The floors of the enclosed *building* with unprotected openings are protected by an
15 *automatic sprinkler system*;

16 2.2. The openings are glazed with either tempered or laminated glazing materials;

17 2.3. When required by the *building official*, the glazing is protected on the parking side
18 with a sprinkler system designed to wet the entire glazed surface; and

19 2.4. The parking areas are used primarily for passenger loading and unloading and
20 vehicle drive-through uses.

21 ***

**TABLE 508.4
REQUIRED SEPARATION OF OCCUPANCIES (HOURS)**

| OCCUPANCY | A, E | | B ^c | | I-1 ^a , I-3, I-4 | | I-2 | | R ^a | | F-2, S-2 ^b , U | | ((B ^a)) F-1, ((M _h)) S-1 | | M | | H-1 | | H-2 | | H-3, H-4 | | H-5 | | |
|---|------|----|----------------|----|-----------------------------|----|-----|----|----------------|----|---------------------------|----------------|---|----|----|----|-----|----|-----|----|----------|----|-----|----|----|
| | S | NS | S | NS | S | NS | S | NS | S | NS | S | NS | S | NS | S | NS | S | NS | S | NS | S | NS | S | NS | |
| A, E | N | N | I | 2 | I | 2 | NP | 1 | 2 | N | 1 | 1 | 2 | 1 | 2 | NP | NP | 3 | 4 | 2 | 3 | 2 | 3 | 2 | NP |
| B ^c | — | — | N | N | I | 2 | NP | 1 | 2 | N | 1 | 2 | 1 | 2 | NP | NP | 2 | 3 | 1 | 2 | 1 | 2 | 1 | NP | |
| I-1 ^a , I-3, I-4 | — | — | — | — | N | N | 2 | NP | 1 | NP | 1 | 2 | 1 | 2 | 1 | 2 | NP | NP | 3 | NP | 2 | NP | 2 | NP | |
| I-2 | — | — | — | — | — | — | — | — | — | 2 | NP | 2 | NP | 2 | NP | 2 | NP | NP | 3 | NP | 2 | NP | 2 | NP | |
| R ^a | — | — | — | — | — | — | — | — | — | N | N | 1 ^c | 2 | 1 | 2 | NP | NP | 3 | NP | 2 | NP | 2 | NP | 2 | NP |
| F-2, S-2 ^b , U | — | — | — | — | — | — | — | — | — | — | — | — | — | — | — | — | — | — | — | — | — | — | — | — | — |
| ((B ^a)) F-1, ((M _h)) S-1 | — | — | — | — | — | — | — | — | — | — | — | — | — | — | — | — | — | — | — | — | — | — | — | — | — |
| M | — | — | — | — | — | — | — | — | — | — | — | — | — | — | — | — | — | — | — | — | — | — | — | — | — |
| H-1 | — | — | — | — | — | — | — | — | — | — | — | — | — | — | — | — | — | — | — | — | — | — | — | — | — |
| H-2 | — | — | — | — | — | — | — | — | — | — | — | — | — | — | — | — | — | — | — | — | — | — | — | — | — |
| H-3, H-4 | — | — | — | — | — | — | — | — | — | — | — | — | — | — | — | — | — | — | — | — | — | — | — | — | — |
| H-5 | — | — | — | — | — | — | — | — | — | — | — | — | — | — | — | — | — | — | — | — | — | — | — | — | — |

S = Buildings equipped throughout with an automatic sprinkler system installed in accordance with Section 903.3.1.1.

NS = Buildings not equipped throughout with an automatic sprinkler system installed in accordance with Section 903.3.1.1.

N = No separation requirement.

NP = Not permitted.

a. See Section 420.

b. The required separation from areas used only for private or pleasure vehicles shall be reduced by 1 hour but not to less than 1 hour.

c. See Section 406.3.4.

d. Separation is not required between occupancies of the same classification.

e. See Section 422.2 for ambulatory care facilities.

1
2
3
4

SECTION 509

INCIDENTAL USES

509.1 General Incidental uses located within single occupancy or mixed occupancy buildings shall comply with the provisions of this section. Incidental uses are ancillary functions associated with a given occupancy that generally pose a greater level of risk to that occupancy and are limited to those uses listed in Table 509.

Exception: Incidental uses within and serving a *dwelling unit* are not required to comply with this section.

| TABLE 509 INCIDENTAL USES | |
|--|---|
| ROOM OR AREA | SEPARATION AND/OR PROTECTION |
| Furnace room where any piece of equipment is over 400,000 Btu per hour input | 1 hour or provide automatic sprinkler system |
| Rooms with boilers where the largest piece of equipment is over 15 psi and 10 horsepower | 1 hour or provide automatic sprinkler system |
| Refrigerant machinery room | 1 hour or provide automatic sprinkler system |
| Hydrogen fuel gas rooms, not classified as Group H | 1 hour in Group B, F, M, S and U occupancies; 2 hours in Group A, E, I and R occupancies. |
| Incinerator rooms | 2 hours and provide automatic sprinkler system |
| Paint shops, not classified as Group H, located in occupancies other than Group F | 2 hours; or 1 hour and provide automatic sprinkler system |
| In Group E occupancies, laboratories and vocational shops not classified as Group H | 1 hour or provide automatic sprinkler system |
| In Group I-2 occupancies, laboratories not classified as Group H | 1 hour and provide automatic sprinkler system |
| In ambulatory care facilities, laboratories not classified as Group H | 1 hour or provide automatic sprinkler system |
| Laundry rooms over 100 square feet | 1 hour or provide automatic sprinkler system |
| In Group I-2, laundry rooms over 100 square feet | 1 hour |
| Group I-3 cells and Group I-2 patient rooms equipped with padded surfaces | 1 hour |

| | |
|---|---|
| In Group I-2, physical plant maintenance shops | 1 hour |
| In ambulatory care facilities or Group I-2 occupancies, waste and linen collection rooms with containers that have an aggregate volume of 10 cubic feet or greater | 1 hour |
| In other than ambulatory care facilities and Group I-2 occupancies, waste and linen collection rooms over 100 square feet | 1 hour or provide automatic sprinkler system |
| In ambulatory care facilities or Group I-2 occupancies, storage rooms greater than 100 square feet | 1 hour |
| Stationary storage battery systems having an <u>aggregate</u> liquid electrolyte capacity of more than 50 gallons for flooded lead-acid, nickel cadmium or VRLA, or more than 1,000 pounds for lithium-ion and lithium metal polymer used for facility standby power, emergency power or uninterruptable power supplies | 1 hour in Group B, F, M, S and U occupancies; 2 hours in Group A, E, I and R occupancies. |
| <u>[W] Dry type transformers over 112.5 kVA and required to be in a fire-resistance-rated room in accordance with Seattle Electrical Code Section 450.21 (B)¹</u> | <u>1 hour or provide automatic sprinkler system</u> |
| <u>Elevator control and machine rooms</u> | <u>See Section 3020.4</u> |
| For SI: 1 square foot = 0.0929 m ² , 1 pound per square inch (psi) = 6.9 kPa, 1 British thermal unit (Btu) per hour = 0.293 watts, 1 horsepower = 746 watts, 1 gallon = 3.785 L, 1 cubic foot = 0.0283 m ³ . | |
| <u>[W] 1 Dry type transformers rated over 35,000 volts and oil-insulated transformers shall be installed in a transformer vault complying with Section 428 and the Seattle Electrical Code.</u> | |

509.3 Area limitations. Incidental uses shall not occupy more than 10 percent of the *building area* of the *story* in which they are located. Incidental uses that occupy more than 10 percent of the *building area* of the *story* in which they are located shall comply with either Table 509 or Section 508.4, whichever requires a greater separation.

SECTION 510

SPECIAL PROVISIONS

1 **510.1 General.** The provisions in Sections 510.2 through 510.9 shall permit the use of special
2 conditions that are exempt from, or modify, the specific requirements of this chapter regarding
3 the allowable *building heights* and *areas of buildings* based on the occupancy classification and
4 type of construction, provided the special condition complies with the provisions specified in this
5 section for such condition and other applicable requirements of this code. The provisions of
6 Sections 510.2 through 510.8 are to be considered independent and separate from each other.

7 **Interpretation I510:** Sections 510.2 through 510.8 are not permitted to be used in
8 combination with each other.

9 **510.2 Horizontal building separation allowance.** A *building* shall be considered as separate
10 and distinct *buildings* for the purpose of determining area limitations, continuity of *fire walls*,
11 limitation of number of *stories* and type of construction where all of the following conditions are
12 met:

- 13 1. The *buildings* are separated with a *horizontal assembly* having a *fire-resistance rating* of
14 not less than 3 hours.
- 15 2. The building below and including the *horizontal assembly* is of Type IA construction.
- 16 3. *Shaft, stairway, ramp* and escalator enclosures through the *horizontal assembly* shall have
17 not less than a 2-hour *fire-resistance rating* with opening protectives in accordance with
18 Section 716.5.

19 **Exception:** Where the enclosure walls below the *horizontal assembly* have not less
20 than a 3-hour *fire-resistance rating* with opening protectives in accordance with
21 Section 716.5, the enclosure walls extending above the *horizontal assembly* shall be
22 permitted to have a 1-hour *fire-resistance rating*, provided:

1 1. The *building* above the *horizontal assembly* is not required to be of Type I
2 construction;

3 2. The enclosure connects fewer than four *stories*; and

4 3. The enclosure opening protectives above the *horizontal assembly* have a *fire*
5 *protection rating* of not less than 1 hour.

6 4. Stairways permitted to be constructed of wood above the *horizontal assembly* are also
7 permitted to be constructed of wood below the *horizontal assembly*. See Section 202 for
8 the definition of *stairway*.

9 5. The *building* or buildings above the *horizontal assembly* shall be permitted to have
10 ((multiple Group A occupancy uses, each with an *occupant load* of less 300, or Group B,
11 M, R or S occupancies)) any of the following occupancies:

12 5.1 Multiple Group A occupancy uses, each with an occupant load of less 300;

13 5.2 Group B;

14 5.3. Group I-1, Condition 2 licensed care facilities;

15 5.4 Group M;

16 5.5. Group R;

17 5.6. Group S-2 parking garage used for the parking and storage of private motor
18 vehicles; and

19 5.7. Uses incidental to the operation or serving occupants of the *building* (including
20 entry lobbies, mechanical rooms, storage areas and similar uses.

21 ~~((5))~~6. The building below the *horizontal assembly* ~~((shall be protected throughout by an~~
22 ~~approved automatic sprinkler system in accordance with Section 903.3.1.1, and shall~~
23 ~~be))~~ is permitted to be any occupancy allowed by this code except Group H.

1 ((6))7. The maximum building height in feet (mm) shall not exceed the limits set forth in
2 Section 504.3 for the *building* having the smaller allowable height as measured from
3 the grade plane.

4 8. All portions of the *buildings* above and below the three-hour *horizontal assembly* shall be
5 protected throughout with an *automatic sprinkler system* that complies with Section
6 903.3.1.1.

7 9. Occupied floors shall be not more than 75 feet above the lowest level of fire department
8 vehicle access.

9 **Interpretation I509.2:** For the purpose of this item, occupied roof decks are considered
10 floors used for human occupancy if the occupant load of the deck is 10 or more on the
11 roof of a building not equipped with an *automatic sprinkler system* or where the occupant
12 load is 50 or more on the roof of a *building* that is equipped with an *automatic sprinkler*
13 *system*.

14 10. Where the structure above the horizontal assembly is of Type V construction, and the
15 structure or any portion of the structure is 7 stories above grade plane in height, all interior
16 exit stairways shall be pressurized in accordance with Section 909.20.6 for low-rise
17 stairways.

18 11. Where the structure above the horizontal assembly is not of Type V construction, interior
19 exit stairways that connect more than 6 stories above the level of exit discharge for the
20 stairway shall be pressurized in accordance with Section 909.20.6 for low-rise stairways.

21 ***

22 **510.4 Parking beneath Group R.** Where a maximum one *story above grade plane* Group S-2
23 parking garage, enclosed or open, or combination thereof, of Type I construction or open of Type

1 IV construction, with grade entrance, is provided under a building of Group R, the number of
2 *stories* to be used in determining the minimum type of construction shall be measured from the
3 floor above such a parking area. The floor assembly between the parking garage and the Group R
4 above shall comply with the type of construction required for the parking garage and shall also
5 provide a *fire-resistance rating* not less than the mixed occupancy separation required in Section
6 508.4. For purposes of this Section, the Group R occupancy shall be no more than four *stories* in
7 height.

8 ***

9 Section 7. The following sections of Chapter 6 of the International Building Code, 2015
10 Edition, are amended as follows:

11 **CHAPTER 6**

12 **TYPES OF CONSTRUCTION**

13 ***

14 **SECTION 602**

15 **CONSTRUCTION CLASSIFICATION**

16 ***

17 **602.3 Type III.** Type III construction is that type of construction in which the exterior walls are
18 of noncombustible materials and the interior building elements are of any material permitted by
19 this code. *Fire-retardant-treated wood* framing complying with Section 2303.2 shall be permitted
20 within *exterior wall* assemblies of a 2-hour rating or less.

21 **Interpretation I602.3:** Type IIIA buildings are permitted to include exposed heavy-timber
22 construction for columns, beams, girders, arches, trusses, floors and roof decks except for fire-
23 resistive construction required by Sections 510 and 713 and Chapter 10.

602.5 Type V. Type V construction is that type of construction in which the structural elements, exterior walls and interior walls are of any materials permitted by this code.

Interpretation I602.5: Type VA buildings are permitted to include exposed heavy-timber construction for columns, beams, girders, arches, trusses, floors and roof decks except for fire-resistive construction required by Sections 510 and 713 and Chapter 10.

**TABLE 601
FIRE-RESISTANCE RATING REQUIREMENTS FOR BUILDING ELEMENTS
(HOURS)**

| BUILDING ELEMENT | TYPE I | | TYPE II | | TYPE III | | TYPE IV | TYPE V | |
|---|---------------|-------|----------|--------|----------|---|-------------------------------|----------|---|
| | A | B | A | B | A | B | H T | A | B |
| Primary structural frame ^f (see Section 202) | 3a | 2a | 1 | 0 | 1 | 0 | HT | 1 | 0 |
| Bearing walls | | | | | | | | | |
| Exterior ^{e, f} | 3 | 2 | 1 | 0 | 2 | 2 | 2 | 1 | 0 |
| Interior | 3a | 2a | 1 | 0 | 1 | 0 | 1/H T | 1 | 0 |
| Nonbearing walls and partitions Exterior | See Table 602 | | | | | | | | |
| Nonbearing walls and partitions Interior ^d | 0 | 0 | 0 | 0 | 0 | 0 | See Section 602.4. 6 | 0 | 0 |
| Floor construction and associated secondary members (see Section 202) | 2 | 2 | 1 | 0 | 1 | 0 | HT | 1 | 0 |
| Roof construction and associated secondary members (see Section 202) | 1 1/2 b | 1b, c | 1b, c | 0 c | 1b, c | 0 | HT | 1b, c | 0 |

For SI: 1 foot = 304.8 mm.

- a. Roof supports: Fire-resistance ratings of primary structural frame and bearing walls are permitted to be reduced by 1 hour where supporting a roof only.
- b. Except in Group F-1, H, M and S-1 occupancies, fire protection of structural members shall not be required, including protection of roof framing and decking where every

part of the roof construction is 20 feet or more above any floor immediately below. Fire-retardant-treated wood members shall be allowed to be used for such unprotected members.

- c. In all occupancies, heavy timber shall be allowed where a 1-hour or less fire-resistance rating is required.
- d. Not less than the fire-resistance rating required by other sections of this code.
- e. Not less than the fire-resistance rating based on fire separation distance (see Table 602).
- f. Not less than the fire-resistance rating as referenced in Section 704.10.

Note: See Sections 1019, 1023 and 603.1 item 27 for stairway construction.

- g. The fire-resistance rating for mezzanines constructed in accordance with Section 505.2 need not exceed 1 hour.

1

TABLE 602
FIRE-RESISTANCE RATING REQUIREMENTS FOR EXTERIOR WALLS BASED ON FIRE SEPARATION DISTANCE^{a,d,g,i}

| FIRE SEPARATION DISTANCE= X (feet) | TYPE OF CONSTRUCTION | OCCUPANCY GROUP H ^c | OCCUPANCY GROUP F-1, M, S-1 ^f | OCCUPANCY GROUP A, B, E, F-2, I, R, S-2, U ^h |
|---------------------------------------|----------------------|--------------------------------|--|---|
| X < 5 ^b | All | 3 | 2 | 1 |
| 5 ≤ X < 10 | IA | 3 | 2 | 1 |
| | Others | 2 | 1 | 1 |
| 10 ≤ X < 30 | IA, IB | 2 | 1 | 1 ^c |
| | IIB, VB | 1 | 0 | 0 |
| | Others | 1 | 1 | 1 ^c |
| X ≥ 30 | All | 0 | 0 | 0 |

For SI: 1 foot = 304.8 mm.

- a. Load-bearing exterior walls shall also comply with the fire-resistance rating requirements of Table 601.
- b. See Section 706.1.1 for party walls.
- c. Open parking garages complying with Section 406 shall not be required to have a fire-resistance rating.
- d. The fire-resistance rating of an exterior wall is determined based upon the fire separation distance of the exterior wall and the story in which the wall is located.
- e. For special requirements for Group H occupancies, see Section 415.6.
- f. For special requirements for Group S aircraft hangars, see Section 412.4.1.
- g. Where Table 705.8 permits nonbearing exterior walls with unlimited area of unprotected openings, the required fire-resistance rating for the exterior walls is 0 hours.
- h. For a building containing only a Group U occupancy private garage or carport, the exterior wall shall not be required to have a fire-resistance rating where the fire separation distance is 5 feet (1523 mm) or greater.
- i. Existing buildings may encroach a maximum of 4 inches into the required fire separation distance, solely for the purpose of adding insulation to the building exterior.

2

SECTION 603

COMBUSTIBLE MATERIAL IN TYPES I AND II CONSTRUCTION

603.1 Allowable materials. Combustible materials shall be permitted in buildings of Type I or II construction in the following applications and in accordance with Sections 603.1.1 through 603.1.3:

1. *Fire-retardant-treated wood* shall be permitted in:

1.1. Nonbearing partitions where the required *fire-resistance rating* is 2 hours or less.

1.2. Nonbearing *exterior walls* where fire-resistance-rated construction is not required.

1.3. Roof construction, including girders, trusses, framing and decking.

Exception: In *buildings* of Type IA construction exceeding two *stories above grade plane*, *fire-retardant-treated wood* is not permitted in roof construction where the vertical distance from the upper floor to the roof is less than 20 feet (6096 mm).

2. Thermal and acoustical insulation, other than foam plastics, having a *flame spread index* of not more than 25.

Exceptions:

1. Insulation placed between two layers of noncombustible materials without an intervening airspace shall be allowed to have a *flame spread index* of not more than 100.

2. Insulation installed between a finished floor and solid decking without intervening airspace shall be allowed to have a *flame spread index* of not more than 200.

3. Foam plastics in accordance with Chapter 26.

4. Roof coverings that have an A, B or C classification.

- 1 5. *Interior floor finish* and floor covering materials installed in accordance with Section
- 2 804.
- 3 6. Millwork such as doors, door frames, window sashes and frames.
- 4 7. *Interior wall and ceiling finishes* installed in accordance with Sections 801 and 803.
- 5 8. *Trim* installed in accordance with Section 806.
- 6 9. Where not installed greater than 15 feet (4572 mm) above grade, show windows,
- 7 nailing or furring strips and wooden bulkheads below show windows, including their
- 8 frames, aprons and show cases.
- 9 10. Finish flooring installed in accordance with Section 805.
- 10 11. Partitions dividing portions of stores, offices or similar places occupied by one tenant
- 11 only and that do not establish a corridor serving an occupant load of 30 or more shall
- 12 be permitted to be constructed of fire-retardant-treated wood, 1-hour fire-resistance-
- 13 rated construction or of wood panels or similar light construction up to 6 feet (1829
- 14 mm) in height.
- 15 12. Stages and platforms constructed in accordance with Sections 410.3 and 410.4,
- 16 respectively.
- 17 13. Combustible exterior wall coverings, balconies and similar projections and bay or
- 18 oriel windows in accordance with Chapter 14.
- 19 14. Blocking such as for handrails, millwork, cabinets and window and door frames.
- 20 15. Light-transmitting plastics as permitted by Chapter 26.
- 21 16. Mastics and caulking materials applied to provide flexible seals between components
- 22 of exterior wall construction.
- 23 17. Exterior plastic veneer installed in accordance with Section 2605.2.

- 1 18. Nailing or furring strips as permitted by Section 803.13.
- 2 19. Heavy timber as permitted by Note c to Table 601 and Sections 602.4.7 and 1406.3.
- 3 20. Aggregates, component materials and admixtures as permitted by Section 703.2.2.
- 4 21. Sprayed fire-resistant materials and intumescent and mastic fire-resistant coatings,
5 determined on the basis of fire resistance tests in accordance with Section 703.2 and
6 installed in accordance with Sections 1705.14 and 1705.15, respectively.
- 7 22. Materials used to protect penetrations in *fire-resistance-rated* assemblies in
8 accordance with Section 714.
- 9 23. Materials used to protect joints in *fire-resistance-rated* assemblies in accordance with
10 Section 715.
- 11 24. Materials allowed in the concealed spaces of buildings of Types I and II construction
12 in accordance with Section 718.5.
- 13 25. Materials exposed within plenums complying with Section 602 of the *International*
14 *Mechanical Code*.
- 15 26. Wall construction of freezers and coolers of less than 1,000 square feet (92.9 m²), in
16 size, lined on both sides with noncombustible materials and the building is protected
17 throughout with an automatic sprinkler system in accordance with Section 903.3.1.1.
- 18 27. Stairways within individual dwelling units and stairways serving a single tenant space
19 are permitted to be of fire-retardant-treated wood or heavy-timber construction. In
20 other than Group R occupancies, such stairways shall not serve as a required means
21 of egress.
- 22 28. Stairways complying with Section 510.2, item 4.
- 23 29. Aluminum is permitted as follows:

1 **Exceptions:**

2 1. Carports are not required to comply with this chapter if they satisfy all the following

3 criteria:

4 1.1. Accessory to Group R-3 occupancies.

5 1.2. Used to shelter only vehicles, trailers or vessels.

6 1.3. Constructed of metal, plastic or fabric.

7 1.4. No more than 3 pounds per square foot in total weight.

8 1.5. No more than 300 square feet covered area.

9 2. Temporary tents and similar structures are not required to comply with this chapter if

10 they satisfy all the following criteria:

11 2.1 The occupant load is less than 100;

12 2.2 The structure is fully or partially enclosed and 400 square feet or less in area; or is
13 entirely unenclosed and 700 square feet or less in area;

14 2.3 The structure is constructed of metal, plastic or fabric; and

15 2.4 The structure is no more than 3 pounds per square foot in total weight.

16 ***

17 **SECTION 703**

18 **FIRE-RESISTANCE RATINGS AND FIRE TESTS**

19 ***

20 **703.3 Methods for determining fire resistance.** The application of any of the methods listed in
21 this section shall be based on the fire exposure and acceptance criteria specified in ASTM E 119
22 or UL 263. The required *fire resistance* of a *building element*, component or assembly shall be
23 permitted to be established by any of the following methods or procedures:

1. *Fire-resistance* designs documented in approved sources.
2. Prescriptive designs of *fire-resistance-rated building elements*, components or assemblies as prescribed in Section 721.
3. Calculations in accordance with Section 722.
4. Engineering analysis based on a comparison of building element, component or assemblies designs having *fire-resistance ratings* as determined by the test procedures set forth in ASTM E 119 or UL 263.
5. Alternative protection methods as allowed by Section ~~((104.14))~~ 104.5.
6. *Fire-resistance* designs certified by an approved agency.

703.7 Marking and identification. Where there is an accessible concealed floor, floor-ceiling or attic space, *fire walls, fire barriers, fire partitions, smoke barriers* and smoke partitions or any other wall required to have protected openings or penetrations shall be effectively and permanently identified with signs or stenciling in the concealed space. Such identification shall:

1. Be located within 15 feet (4572 mm) of the end of each wall and at intervals not exceeding 30 feet (9144 mm) measured horizontally along the wall or partition.
2. Include lettering not less than 3 inches (76 mm) in height with a minimum 3/8-inch (9.5 mm) stroke in a contrasting color incorporating the suggested wording, "FIRE AND/OR SMOKE BARRIER—PROTECT ALL OPENINGS," or other similar wording.

SECTION 704

FIRE-RESISTANCE RATING OF STRUCTURAL MEMBERS

1 **704.4 Protection of secondary members.** Secondary members that are required to have
2 protection to achieve a *fire-resistance rating* shall be protected by individual encasement
3 protection.

4 **704.4.1 Light-frame construction.** Studs and boundary elements that are integral elements
5 in *load-bearing walls* of light-frame construction shall be permitted to have required *fire-*
6 *resistance ratings* provided by the membrane protection provided for the *load-bearing wall*.

7 **704.4.2 Horizontal assemblies.** (~~Horizontal~~) Secondary members within horizontal
8 *assemblies* are permitted to be protected with a membrane or ceiling where the membrane or
9 ceiling provides the required *fire-resistance rating* and is installed in accordance with Section
10 711.

11 ***

12 SECTION 705

13 EXTERIOR WALLS

14 **705.1 General.** *Exterior walls* shall comply with this section.

15 **705.2 Projections.** Cornices, eave overhangs, exterior balconies and similar projections
16 extending beyond the (~~exterior wall~~) building area shall conform to the requirements of this
17 section and Section 1406. Exterior egress balconies and exterior exit stairways and ramps shall
18 comply with Sections 1021 and 1027, respectively. Projections shall not extend any closer to the
19 line used to determine the fire separation distance than shown in Table 705.2.

20 **Exception:** *Buildings* on the same lot and considered as portions of one *building* in
21 accordance with Section 705.3 are not required to comply with this section for projections
22 between the *buildings*.

1 **Code Alternate CA705.2:** Private balconies and decks constructed with grated metal decking
2 that allows smoke and heat to ventilate are permitted to be considered projections and not floor
3 area. Noncombustible exterior structure supporting only the grated balcony or deck is not
4 required to be fire-resistance rated. Exterior exposed noncombustible columns supporting the
5 grated decks are not required to be fire-resistance rated.

6 **Interpretation I705.2:** For purposes of Section 705.2, gutters 6 inches or less in width that are
7 not an integral part of the structure are not considered projections on Group R-3 occupancies
8 and on Group U accessory occupancies.

9
TABLE 705.2
MINIMUM DISTANCE OF PROJECTION

| FIRE SEPARATION DISTANCE (FSD) | MINIMUM DISTANCE FROM LINE USED TO DETERMINE FSD |
|--|---|
| 0 feet to 2 feet | Projections not permitted |
| Greater than 2 feet to 3 feet | 24 inches |
| Greater than 3 feet to less than 30 feet | 24 inches plus 8 inches for every foot of FSD beyond 3 feet or fraction thereof |
| 30 feet or greater | 20 feet |

For SI: 1 foot = 304.8 mm; 1 inch = 25.4 mm.

10 **705.2.1 Type I and II construction.** Projections from walls of Type I or II construction shall
11 be of noncombustible materials or combustible materials as allowed by Sections 1406.3 and
12 1406.4.

13 **705.2.2 Type III, IV or V construction.** Projections from walls of Type III, IV or V
14 construction shall be of any *approved* material.

1 Eave overhangs from walls of Types IIIA, IV or VA construction or from walls that are
2 otherwise required to be of *fire-resistance-rated* construction shall be finished on the
3 underside with at least 1/2-inch (13 mm) gypsum sheathing or equivalent or shall be heavy-
4 timber construction conforming to Section 602.4. Vents are permitted to be installed if the
5 vent openings are covered with corrosion-resistant metal mesh.

6 See Section 714.4.2 for allowable vent penetrations.

7 **705.2.3 Combustible projections.** Combustible projections extending to within 5 feet (1524
8 mm) of the line used to determine the *fire separation distance* shall be of not less than 1-hour
9 *fire-resistance-rated* construction, Type IV construction, *fire-retardant-treated wood* or as
10 required by Section 1406.3.

11 **Exceptions:**

12 1. Type VB construction shall be allowed for combustible projections in Group R-3
13 and U occupancies with a fire separation distance greater than or equal to 5 feet
14 (1524 mm).

15 2. Eave overhangs are permitted to be of less than one-hour construction provided
16 the underside is finished with at least 1/2-inch (13 mm) gypsum sheathing or
17 equivalent.

18 **705.3 Buildings on the same lot.** For the purposes of determining the required wall and opening
19 protection, projections and roof-covering requirements, *buildings* on the same lot shall be
20 assumed to have an imaginary line between them.

21 Where a new *building* is to be erected on the same lot as an existing *building*, the location of
22 the assumed imaginary line with relation to the existing building shall be such that the *exterior*

1 *wall* and opening protection of the *existing building* meet the criteria as set forth in Sections
2 705.5 and 705.8.

3 **Exceptions:**

- 4 1. Two or more *buildings* on the same lot shall be either regulated as separate *buildings* or
5 shall be considered as portions of one *building* if the aggregate area of such *buildings*
6 is within the limits specified in Chapter 5 for a single building. Where the *buildings*
7 contain different occupancy groups or are of different types of construction, the area
8 shall be that allowed for the most restrictive occupancy or construction.
- 9 2. Where an S-2 parking garage of Construction Type I or IIA is erected on the same lot
10 as a Group R-2 building, and ~~((there is no *fire separation distance* between these~~
11 ~~*buildings*))~~ where openings are not permitted or are required by this code to be
12 protected, then the adjoining *exterior walls* between the buildings are permitted to
13 have occupant use openings in accordance with Section 706.8. However, opening
14 protectives in such openings shall only be required in the exterior wall of the S-2
15 parking garage, not in the exterior wall openings in the R-2 building, and these
16 opening protectives in the exterior wall of the S-2 parking garage shall be not less than
17 1-1/2-hour *fire protection rating*.

18 ***

19 **705.8 Openings.** Openings in *exterior walls* shall comply with Sections 705.8.1 through 705.8.6.
20 For spaces that are not provided with *exterior walls*, the vertical plane at the edge of the
21 horizontal projection of the roof or floor is considered an exterior wall.

1 **705.8.1 Allowable area of openings.** The maximum area of unprotected and protected
2 openings permitted in an *exterior wall* in any *story* of a building shall not exceed the
3 percentages specified in Table 705.8.

4 **Exceptions:**

5 1. In other than Group H occupancies, unlimited unprotected openings are permitted
6 in the first *story* above grade plane either:

7 1.1. Where the wall faces a street and has a *fire separation distance* of more than
8 ((15 feet (4572)) 30 feet (9144 mm)); or

9 1.2. Where the wall faces an unoccupied space. The unoccupied space shall be on
10 the same lot or dedicated for public use, shall be not less than 30 feet (9144
11 mm) in width and shall have access from a street by a posted fire lane in
12 accordance with the *International Fire Code*.

13 2. Buildings whose exterior bearing walls, exterior nonbearing walls and exterior
14 primary structural frame are not required to be *fire-resistance rated* shall be
15 permitted to have unlimited unprotected openings.

16 **Interpretation I705.8:** For purposes of Section 705.8, where the *fire separation distance* on
17 a lower floor is greater than the *fire separation distance* on the floor above, there are two
18 options for wall, soffit, and opening protection. The fire-resistance rating of the soffit shall
19 be no less than required rating for floor construction by Table 601.

20 **Option 1:** The plane that projects vertically from the edge of the story, roof or deck above
21 shall comply with the exterior wall and opening protection requirements. The portion of the
22 plane where the wall is recessed is considered an opening. The fire-resistance rating of the
23 soffit shall be no less than required rating for the recessed exterior wall.

1 **Option 2:** Recessed exterior walls shall comply with the wall fire rating and wall opening
2 protection percentages as if the fire separation distance is equal to the story, roof or deck
3 above. The soffit shall be fire-resistance rated not less than as required for the recessed
4 exterior wall.
5 See Figures I705.8a and I705.8b.

Interpretation I705.8:
Option 1. Exterior wall protection extends from A to B to C.
Option 2. Exterior wall protection extends from A to B to B1 to C1. Fire-resistance rating and opening protection for wall B-B1-C1, and fire-resistance rating at soffit B-B1-C1-C comply with requirements for wall B-C. The length of the wall segment B-B1 shall be included when calculating the percentage of openings allowed.

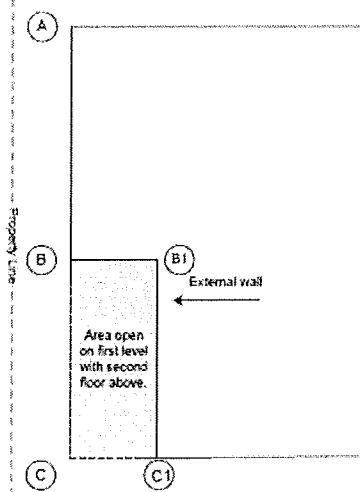

Figure I705.8a
Plan View

Note: Opening protection in wall C to C1 isn't considered in Figures I705.8a and I705.8b because it is perpendicular to the property line.

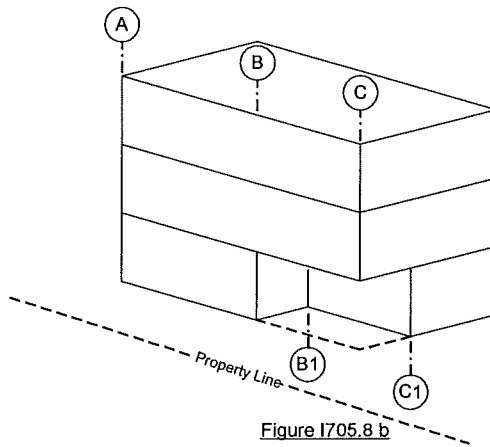

Figure I705.8 b

6
7
8
9

| TABLE 705.8 MAXIMUM AREA OF EXTERIOR WALL OPENINGS BASED ON FIRE SEPARATION DISTANCE AND DEGREE OF OPENING PROTECTION | | |
|--|---|-----------------------------------|
| FIRE SEPARATION DISTANCE (feet)^l | DEGREE OF OPENING PROTECTION | ALLOWABLE AREA^a |
| 0 to less than 3 ^{b, c, k} | Unprotected, Nonsprinklered (UP, NS) | Not Permitted ^k |
| | Unprotected, Sprinklered (UP, S) ⁱ | Not Permitted ^k |
| | Protected (P) | Not Permitted ^k |
| 3 to less than 5 ^{d, e} | Unprotected, Nonsprinklered (UP, NS) | Not Permitted |
| | Unprotected, Sprinklered (UP, S) ⁱ | 15% |
| | Protected (P) | 15% |
| 5 to less than 10 ^{e, f, j} | Unprotected, Nonsprinklered (UP, NS) | 10% ^h |
| | Unprotected, Sprinklered (UP, S) ⁱ | 25% |
| | Protected (P) | 25% |
| 10 to less than 15 ^{e, f, g, j} | Unprotected, Nonsprinklered (UP, NS) | 15% ^h |
| | Unprotected, Sprinklered (UP, S) ⁱ | 45% |
| | Protected (P) | 45% |
| 15 to less than 20 ^{f, g, j} | Unprotected, Nonsprinklered (UP, NS) | 25% |
| | Unprotected, Sprinklered (UP, S) ⁱ | 75% |
| | Protected (P) | 75% |
| 20 to less than 25 ^{f, g, j} | Unprotected, Nonsprinklered (UP, NS) | 45% |
| | Unprotected, Sprinklered (UP, S) ⁱ | No Limit |
| | Protected (P) | No Limit |
| 25 to less than 30 ^{f, g, j} | Unprotected, Nonsprinklered (UP, NS) | 70% |
| | Unprotected, Sprinklered (UP, S) ⁱ | No Limit |
| | Protected (P) | No Limit |
| 30 or greater | Unprotected, Nonsprinklered (UP, NS) | No Limit |
| | Unprotected, Sprinklered (UP, S) ⁱ | No Limit |
| | Protected (P) | No Limit |
| For SI: 1 foot = 304.8 mm. UP, NS = Unprotected openings in buildings not equipped throughout with an <i>automatic sprinkler system</i> in accordance with Section 903.3.1.1. | | |

UP, S = Unprotected openings in buildings equipped throughout with an *automatic sprinkler system* in accordance with Section 903.3.1.1.
P = Openings protected with an opening protective assembly in accordance with Section 705.8.2.

- a. Values indicated are the percentage of the area of the exterior wall, per story.
- b. For the requirements for fire walls of *buildings* with differing heights, see Section 706.6.1.
- c. For openings in a *fire wall* for *buildings* on the same lot, see Section 706.8.
- d. The maximum percentage of unprotected and protected openings shall be 25 percent for Group R-3 occupancies.
- e. Unprotected openings shall not be permitted for openings with a *fire separation distance* of less than 15 feet for Group H-2 and H-3 occupancies.
- f. The area of unprotected and protected openings shall not be limited for Group R-3 occupancies, with a *fire separation distance* of 5 feet or greater.
- g. The area of openings in an open parking structure with a *fire separation distance* of 10 feet or greater shall not be limited.
- h. Includes buildings accessory to Group R-3.
- i. Not applicable to Group H-1, H-2 and H-3 occupancies.
- j. The area of openings in a building containing only a Group U occupancy private garage or carport with a fire separation distance of 5 feet (1523 mm) or greater shall not be limited.
- k. For openings between S-2 parking garage and Group R-2 building, see Section 705.3, Exception 2.
- l. For the purpose of calculating the maximum area of exterior wall openings on existing buildings, the fire separation distances indicated in the chart may be reduced by a maximum of 4 inches, solely for the purpose of adding insulation to the building exterior.

SECTION 706

FIRE WALLS

~~((706.2 Structural stability. Fire walls shall be designed and constructed to allow collapse of the structure on either side without collapse of the wall under fire conditions. Fire walls designed and constructed in accordance with NFPA 221 shall be deemed to comply with this section.))~~

706.3 Materials. Fire walls that separate a building of Type I or II construction from a building of any construction type shall be of any approved noncombustible materials. Other fire walls

shall be built of materials consistent with the types permitted for the type of construction of the building.

~~((Exception: Buildings of Type V construction.))~~

706.4 Fire-resistance rating. *Fire walls* shall have a *fire-resistance rating* of not less than that required by Table 706.4.

| TABLE 706.4 FIRE WALL FIRE-RESISTANCE RATINGS | |
|--|-----------------------------------|
| GROUP | FIRE-RESISTANCE RATING (hours) |
| A, B, E, H-4, I, R-1, R-2, U | 3a |
| F-1, H-3 ^b , H-5, M, S-1 | 3 |
| H-1, H-2 | 4 ^b |
| F-2, S-2, R-3((, R-4)) | 2 |
| a. In Type II or V construction, walls shall be permitted to have a 2-hour <i>fire-resistance rating</i> . | |
| b. For Group H-1, H-2 or H-3 buildings, also see Sections 415.7 and 415.8. | |

706.6 Vertical continuity. *Fire walls* shall extend from the foundation to a termination point not less than 30 inches (762 mm) above both adjacent roofs.

Exceptions:

1. Stepped *buildings* in accordance with Section 706.6.1.
2. Two-hour *fire-resistance-rated* walls shall be permitted to terminate at the underside of the roof sheathing, deck or slab, provided:
 - 2.1. The ~~((lower))~~ *roof assembly* within 4 feet (1220 mm) of the wall has not less than a 1-hour *fire-resistance rating* and the entire length and span of supporting elements for the rated roof assembly has a *fire-resistance rating* of not less than 1 hour.

1 2.2. Openings in the roof shall not be located within 4 feet (1220 mm) of the
2 *fire wall*.

3 2.3. Each *building* shall be provided with not less than a Class B roof
4 covering.

5 3. Walls shall be permitted to terminate at the underside of noncombustible
6 roof sheathing, deck or slabs where both buildings are provided with not
7 less than a Class B roof covering. Openings in the roof shall not be located
8 within 4 feet (1220 mm) of the *fire wall*.

9 4. In *buildings* of Type III, IV and V construction, walls shall be permitted to
10 terminate at the underside of combustible roof sheathing or decks,
11 provided:

12 4.1. There are no openings in the roof within 4 feet (1220 mm) of the *fire*
13 *wall*,

14 4.2. The roof is covered with a minimum Class B roof covering, and

15 4.3. The roof sheathing or deck is constructed of *fire-retardant-treated*
16 *wood* for a distance of 4 feet (1220 mm) on both sides of the wall or the
17 roof is protected with 5/8-inch (15.9 mm) Type X gypsum board
18 directly beneath the underside of the roof sheathing or deck, supported
19 by not less than 2-inch (51 mm) nominal ledgers attached to the sides of
20 the roof framing members for a distance of not less than 4 feet (1220
21 mm) on both sides of the *fire wall*.

1 5. In buildings designed in accordance with Section 510.2, *fire walls* located
2 above the 3-hour *horizontal assembly* required by Section 510.2, Item 1
3 shall be permitted to extend from the top of this *horizontal assembly*.

4 6. Buildings with sloped roofs in accordance with Section 706.6.2.

5 ***

6 **706.6.2 Buildings with sloped roofs.** Where a *fire wall* serves as an interior wall for a
7 building, and the roof on one side or both sides of the fire wall slopes toward the fire wall at
8 a slope greater than two units vertical in 12 units horizontal (2:12), the *fire wall* shall extend
9 to a height equal to the height of the roof located 4 feet (1219 mm) from the *fire wall* plus 30
10 inches (762 mm). In no case shall the extension of the fire wall be less than 30 inches (762
11 mm).

12 **Exceptions:**

13 1. Two-hour fire-resistance-rated walls shall be permitted to terminate at the underside
14 of the roof sheathing, deck or slab, provided:

15 1.1. The roof assembly within 4 feet (1220 mm) of the wall has not less than a 1-hour
16 fire-resistance rating and the entire length and span of supporting elements for the
17 rated roof assembly has a fire-resistance rating of not less than 1 hour.

18 1.2. Openings in the roof shall not be located within 4 feet (1220 mm) of the fire
19 wall.

20 1.3. Each building shall be provided with not less than a Class B roof covering.

21 2. Walls shall be permitted to terminate at the underside of noncombustible roof
22 sheathing, deck or slabs where both buildings are provided with not less than a Class

1 B roof covering. Openings in the roof shall not be located within 4 feet (1220 mm)
2 of the *fire wall*.

3 3. In buildings of Type III, IV and V construction, walls shall be permitted to terminate
4 at the underside of combustible roof sheathing or decks, provided:

5 3.1. There are no openings in the roof within 4 feet (1220 mm) of the *fire wall*,

6 3.2. The roof is covered with a minimum Class B roof covering, and

7 3.3. The roof sheathing or deck is constructed of *fire-retardant-treated wood* for a
8 distance of 4 feet (1220 mm) on both sides of the wall or the roof is protected

9 with 5/8-inch (15.9 mm) Type X gypsum board directly beneath the underside of
10 the roof sheathing or deck, supported by a minimum of 2-inch (51 mm) nominal

11 ledgers attached to the sides of the roof framing members for a minimum distance
12 of 4 feet (1220 mm) on both sides of the *fire wall*.

13 ***

14 **SECTION 708**

15 **FIRE PARTITIONS**

16 **708.1 General.** The following wall assemblies shall comply with this section.

- 17 1. Separation walls as required by Section 420.2 for Groups I-1, R-1, R-2 and R-3.
- 18 2. Walls separating tenant spaces in *covered and open mall buildings* as required by Section
- 19 402.4.2.1.
- 20 3. Corridor walls as required by Section 1020.1.
- 21 4. Elevator lobby separation as required by Section ((~~3006.2~~) 713.14).
- 22 5. Egress balconies as required by Section 1019.2.

- 1 3. Where the *corridor* ceiling is constructed as required for the *corridor* walls, the walls
2 shall be permitted to terminate at the upper membrane of such ceiling assembly.
- 3 4. The fire partitions separating tenant spaces in a *covered or open mall building*,
4 complying with Section 402.4.2.1, are not required to extend beyond the underside of
5 a ceiling that is not part of a fire-resistance-rated assembly. A wall is not required in
6 *attic* or ceiling spaces above tenant separation walls.
- 7 5. Attic fireblocking or draftstopping is not required at the partition line in Group R-2
8 buildings that do not exceed four *stories above grade plane*, provided the *attic* space is
9 subdivided by draftstopping into areas not exceeding 3,000 square feet (279 m2) or
10 above every two *dwelling units*, whichever is smaller.
- 11 6. Fireblocking or draftstopping is not required at the partition line in buildings equipped
12 with an *automatic sprinkler system* installed throughout in accordance with Section
13 903.3.1.1 or 903.3.1.2, provided that automatic sprinklers are installed in combustible
14 floor/ceiling and roof/ceiling spaces.

15 ***

16 SECTION 709

17 SMOKE BARRIERS

18 ***

19 **709.4 Continuity.** *Smoke barriers* shall form an effective membrane continuous from the top of
20 the foundation or floor/ceiling assembly below to the underside of the floor or roof sheathing,
21 deck or slab above, including continuity through concealed spaces, such as those found above
22 suspended ceilings, and interstitial structural and mechanical spaces. The supporting construction
23 shall be protected to afford the required *fire-resistance rating* of the wall or floor supported in

1 buildings of other than Type IIB, IIIB or VB construction. *Smoke barrier* walls used to separate
2 smoke compartments shall comply with Section 709.4.1. *Smoke-barrier* walls used to enclose
3 *areas of refuge* in accordance with Section 1009.6.4 or to enclose elevator lobbies in accordance
4 with Section 403.6.1.5, 403.6.2.6 or 405.4.3(~~(, 3007.6.2, or 3008.6.2)~~) shall comply with Section
5 709.4.2.

6 **Exception:** *Smoke-barrier* walls are not required in interstitial spaces where such spaces are
7 designed and constructed with ceilings or *exterior walls* that provide resistance to the passage
8 of fire and smoke equivalent to that provided by the *smoke-barrier* walls.

9 **709.4.1 Smoke-barrier walls separating smoke compartments.** *Smoke-barrier* walls used
10 to separate smoke compartments shall form an effective membrane continuous from outside
11 wall to outside wall.

12 **709.4.2 Smoke-barrier walls enclosing areas of refuge or elevator lobbies.** *Smoke-barrier*
13 walls used to enclose areas of refuge in accordance with Section 1009.6.4, or to enclose
14 elevator lobbies in accordance with Section 403.6.1.5, 403.6.2.6 or 405.4.3(~~(, 3007.6.2, or~~
15 ~~3008.6.2)~~), shall form an effective membrane enclosure that terminates at a *fire barrier* wall
16 having a level of *fire protection rating* not less than 1 hour, another *smoke barrier* wall or an
17 outside wall. A smoke and draft control door assembly as specified in Section 716.5.3.1 shall
18 not be required at each elevator hoistway door opening or at each exit doorway between an
19 area of refuge and the exit enclosure.

20 ***

21 **SECTION 712**

22 **VERTICAL OPENINGS**

1 **712.1 General.** Each vertical opening shall comply in accordance with one of the protection
2 methods in Sections 712.1.1 through ((712.1.16)) 712.1.17.

3 **712.1.1 Shaft enclosures.** Vertical openings contained entirely within a shaft enclosure
4 complying with Section 713 shall be permitted. Elevator hoistways shall be protected in
5 accordance with Section 713.14.2.

6 **712.1.2 Individual dwelling unit.** Unconcealed vertical openings totally within an individual
7 residential *dwelling unit* and connecting four *stories* or less shall be permitted.

8 **712.1.3 Escalator openings.** Where a *building* is equipped throughout with an *automatic*
9 *sprinkler system* in accordance with Section 903.3.1.1, vertical openings for escalators shall
10 be permitted where protected in accordance with Section 712.1.3.1 or 712.1.3.2.

11 **712.1.3.1 Opening size.** Protection by a draft curtain and closely spaced sprinklers in
12 accordance with NFPA 13 shall be permitted where the area of the vertical opening
13 between *stories* does not exceed twice the horizontal projected area of the escalator. In
14 other than Groups B and M, this application is limited to openings that do not connect
15 more than four *stories*.

16 **Note:** NFPA 13 requires draft curtains to be at least 18 inches (457 mm) deep, and to be
17 of noncombustible or limited-combustible material.

18 ***

19 **712.1.10 Parking garages.** Vertical openings in parking garages for automobile ramps,
20 elevators and duct systems shall comply with Section 712.1.10.1, 712.1.10.2 or 712.1.10.3,
21 as applicable.

1 **712.1.10.1 Automobile ramps.** Vertical openings for automobile ramps in (~~open and~~
2 ~~enclosed~~) parking garages shall be permitted where constructed in accordance with
3 Sections 406.5 and 406.6, (~~respectively~~).

4 **712.1.10.2 Elevators.** Non-fire-resistance rated (~~(V)~~) vertical openings for elevator
5 hoistways in (~~open or enclosed~~) parking garages that serve only the parking garage, and
6 complying with Sections 406.5 and 406.6(~~, respectively~~) shall be permitted.

7 Note: When Section 712.1.10.2 is applied, the hoistway will be required to be enclosed,
8 but it is not required to be fire-resistance rated. See Section 3020.1.

9 **712.1.10.3 Duct systems.** Vertical openings for mechanical exhaust or supply duct
10 systems in (~~open or enclosed~~) parking garages complying with Sections 406.5 and
11 406.6(~~, respectively~~) shall be permitted to be unenclosed where such duct system is
12 contained within and serves only the parking garage.

13 ***

14 **712.1.16 Gas vents and piping.** Vertical openings for penetrations of floors inside a wall
15 cavity by gas vents and piping in buildings of Types III, IV, and V construction shall be
16 permitted.

17 **712.1.17 (~~(16)~~) Openings otherwise permitted.** Vertical openings shall be permitted where
18 allowed by other sections of this code.

19 SECTION 713

20 SHAFT ENCLOSURES

21 ***

22 **713.4 Fire-resistance rating.** *Shaft enclosures* shall have a *fire-resistance rating* of not less than
23 2 hours where connecting more than four stories (~~(or more)~~), and not less than 1 hour where

1 connecting (~~less than~~) four and fewer stories. The number of *stories* connected by the *shaft*
2 *enclosure* shall include any basements but not any *mezzanines*. *Shaft enclosures* shall have a *fire-*
3 *resistance rating* not less than the floor assembly penetrated, but need not exceed 2 hours. *Shaft*
4 *enclosures* shall meet the requirements of Section 703.2.1.

5 ***

6 **713.8 Penetrations.** Penetrations in a *shaft enclosure* shall be protected in accordance with
7 Section 714 as required for *fire barriers*. Structural elements, such as beams or joists, where
8 protected in accordance with Section 714 shall be permitted to penetrate a *shaft enclosure*. See
9 Section 3022 for installation of pipes and ducts in elevator hoistways.

10 **713.8.1 Prohibited penetrations.** Penetrations other than those necessary for the purpose of
11 the shaft shall not be permitted in *shaft enclosures*.

12 ***

13 **713.14 Elevator, dumbwaiter and other hoistways.** Elevator, dumbwaiter and other hoistway
14 enclosures shall be constructed in accordance with this section (~~(Section 713 and Chapter 30)~~).

15 **713.14.1 General.** Elevator hoistway openings and enclosed elevator lobbies shall be provided
16 in accordance with the following:

17 1. Where hoistway opening protection is required by Section 713.14.2, such protection shall

18 be in accordance with Section 713.14.3.

19 2. Where enclosed elevator lobbies are required for underground buildings, such lobbies shall

20 comply with Section 405.4.3.

21 3. Where an area of refuge is required and an enclosed elevator lobby is provided to serve as

22 an area of refuge, the enclosed elevator lobby shall comply with Section 1009.6.

1 4. Where fire service access elevators are provided, enclosed elevator lobbies shall comply
2 with Section 403.6.1.5.

3 5. Where occupant evacuation elevators are provided, enclosed elevator lobbies shall comply
4 with Section 403.6.2.6.

5 **Exception:** Elevators in parking garages are permitted to comply with 712.1.9.

6 **713.14.2 Hoistway opening protection required.** Elevator hoistway door openings shall be
7 protected in accordance with Section 713.14.3 where an elevator hoistway connects more than
8 three stories, is required to be enclosed within a shaft enclosure in accordance with Section
9 712.1.1, and any of the following conditions apply:

10 1. The building is not protected throughout with an automatic sprinkler system in
11 accordance with Section 903.3.1.1 or 903.3.1.2.

12 2. The building contains a Group I-1 Condition 2 occupancy.

13 3. The building contains a Group I-2 occupancy.

14 4. The building contains a Group I-3 occupancy.

15 5. The building is a high rise and the elevator hoistway is more than 75 feet (22 860 mm)
16 in height. The height of the hoistway shall be measured from the lowest floor to the
17 highest floor of the floors served by the hoistway.

18 **Exceptions:**

19 1. Protection of elevator hoistway door openings is not required where the elevator
20 serves only open parking garages in accordance with Section 406.5.

21 2. Protection of elevator hoistway door openings is not required at the level(s) of exit
22 discharge, provided the level(s) of exit discharge is equipped with an automatic
23 sprinkler system in accordance with Section 903.3.1.1.

1 3. Enclosed elevator lobbies and protection of elevator hoistway door openings are
2 not required on levels where the elevator hoistway opens to the exterior.

3 **713.14.2.1 Rated corridors.** Where corridors are required to be fire resistance rated in
4 accordance with Section 1020.1, elevator hoistway openings shall be protected in
5 accordance with Section 713.14.3.

6 **713.14.3 Hoistway opening protection.** Where Section 713.14.2 requires protection of the
7 elevator hoistway door opening, the protection shall be provided by one of the following:

8 1. An enclosed elevator lobby shall be provided at each floor to separate the elevator
9 hoistway shaft enclosure doors from each floor by fire partitions in accordance with
10 Section 708. In addition, doors protecting openings in the elevator lobby enclosure walls
11 shall comply with Section 716.5.3 as required for corridor walls and shall be automatic-
12 closing by actuation of a smoke detector in accordance with Section 716.5.9.3.

13 Penetrations of the enclosed elevator lobby by ducts and air transfer openings shall be
14 protected as required for corridors in accordance with Section 717.5.4.1.

15 2. An enclosed elevator lobby shall be provided at each floor to separate the elevator
16 hoistway shaft enclosure doors from each floor by smoke partitions in accordance with
17 Section 710 where the building is equipped throughout with an automatic sprinkler
18 system installed in accordance with Section 903.3.1.1 or 903.3.1.2. In addition, doors
19 protecting openings in the smoke partitions shall comply with Sections 710.5.2.2,
20 710.5.2.3 and 716.5.9. Penetrations of the enclosed elevator lobby by ducts and air
21 transfer openings shall be protected as required for corridors in accordance with Section
22 717.5.4.1.

1 3. Additional doors shall be provided at each elevator hoistway door opening at the point of
2 access to the elevator car. Such door shall comply with the smoke and draft control door
3 assembly requirements in Section 716.5.3.1 when tested in accordance with UL 1784
4 without an artificial bottom seal. They shall be maintained automatic closing by actuation
5 of a smoke detector in accordance with Section 716.5.9.3. Doors that latch shall be
6 provide with panic hardware, openable from inside the elevator car. The doors shall be
7 readily openable from the car side without a key, tool, or special knowledge or effort.

8 4. The elevator hoistway shall be pressurized in accordance with Section 909.21.

9 713.14.4 Means of egress. Elevator lobbies shall be provided with at least one means of egress
10 complying with Chapter 10 and other provisions in this code. Egress through an elevator lobby
11 shall be permitted in accordance with Item 1 of Section 1016.2.

12 713.15 Chimneys and fireplaces. Approved factory-built chimneys shall be installed within
13 shafts as required by Section 713.

14 **Exception:** Factory-built chimneys that are exposed to the exterior in an *approved* manner
15 are not required to be installed in shafts.

16 Approved chimneys serving multiple dwelling units are permitted to be installed within the
17 same shaft, provided approved metal draft stops are installed at each floor level. All combustible
18 construction shall be protected as required for *fire-resistance-rated* shaft construction. Interior
19 shaft wall joints shall be fire-taped where required and where space allows, but fire-taping is
20 permitted to be omitted from joints on the final closure wall provided the joints are installed in a
21 tight manner.

22 The back of listed manufactured fireplace boxes is permitted to replace that portion of the
23 shaft wall where they are located, provided the joint between the box and the adjacent shaft wall

1 is tightly constructed and installed according to manufacturer's specification. Fresh air make-up
2 ducts required by the Energy or Mechanical codes are permitted to penetrate the shaft at the fire
3 box. Fresh air make-up ducts which pass through any portion of the building other than the shaft
4 shall be at least 26 gage metal.

5 SECTION 714

6 PENETRATIONS

7 ***

8 **714.4.2 Membrane penetrations.** Penetrations of membranes that are part of a *horizontal*
9 *assembly* shall comply with Section 714.4.1.1 or 714.4.1.2. Where floor/ceiling assemblies
10 are required to have a *fire-resistance rating*, recessed fixtures shall be installed such that the
11 required *fire resistance* will not be reduced.

12 Exceptions:

- 13 1. *Membrane penetrations* by steel, ferrous or copper conduits, pipes, tubes or vents,
14 or concrete or masonry items where the *annular space* is protected either in
15 accordance with Section 714.4.1 or to prevent the free passage of flame and the
16 products of combustion. The aggregate area of the openings through the membrane
17 shall not exceed 100 square inches (64 500 mm²) in any
18 100 square feet (9.3 m²) of ceiling area in assemblies tested without penetrations.
- 19 2. Ceiling *membrane penetrations* of maximum 2-hour *horizontal assemblies* by steel
20 electrical boxes that do not exceed 16 square inches (10 323 mm²) in area, provided
21 the aggregate area of such penetrations does not exceed 100 square inches (44 500
22 mm²) in any 100 square feet (9.29 m²) of ceiling area, and the *annular space*
23 between the ceiling membrane and the box does not exceed 1/8 inch (3.2 mm).

- 1 3. *Membrane penetrations* by electrical boxes of any size or type, that have been
2 *listed* as part of an opening protective material system for use in *horizontal*
3 *assemblies* and are installed in accordance with the instructions included in the
4 listing.
- 5 4. *Membrane penetrations* by *listed* electrical boxes of any material, provided such
6 boxes have been tested for use in *fire-resistance-rated* assemblies and are installed
7 in accordance with the instructions included in the listing. The *annular space*
8 between the ceiling membrane and the box shall not exceed 1/8 inch (3.2 mm)
9 unless *listed* otherwise.
- 10 5. The *annular space* created by the penetration of a fire sprinkler, provided it is
11 covered by a metal escutcheon plate.
- 12 6. Noncombustible items that are cast into concrete building elements and that do not
13 penetrate both top and bottom surfaces of the element.
- 14 7. The ceiling membrane of 1- and 2-hour *fire-resistance-rated horizontal assemblies*
15 is permitted to be interrupted with the double wood top plate of a wall assembly that
16 is sheathed with Type X gypsum wallboard, provided that all penetrating items
17 through the double top plates are protected in accordance with Section 714.4.1.1 or
18 714.4.1.2 and the ceiling membrane is tight to the top plates.
- 19 8. Ventilation openings are permitted in the enclosed underside of combustible
20 balconies and decks provided the closest edge of the vent opening is not more than
21 12 inches from the outer edge of the balcony or deck. Such vents must be covered
22 with non-combustible corrosion resistant metal mesh. Solid blocking shall be
23 installed between projecting framing members at the exterior building wall.

1 ***

2 **SECTION 716**

3 **OPENING PROTECTIVES**

4 ***

5 **716.4 Alternative methods for determining fire protection ratings.** The application of any of
6 the alternative methods *listed* in this section shall be based on the fire exposure and acceptance
7 criteria specified in NFPA 252, NFPA 257 or UL 9. The required *fire resistance* of an opening
8 protective shall be permitted to be established by any of the following methods or procedures:

- 9 1. Designs documented in *approved* sources.
- 10 2. Calculations performed in an *approved* manner.
- 11 3. Engineering analysis based on a comparison of opening protective designs having *fire*
12 *protection ratings* as determined by the test procedures set forth in NFPA 252, NFPA 257
13 or UL 9.
- 14 4. Alternative protection methods as allowed by Section ((104.11)) 104.5.

15 ***

16 **716.5.9 Door closing.** *Fire doors* shall be latching and self- or automatic-closing in
17 accordance with this section.

18 **Exceptions:**

- 19 1. *Fire doors* located in common walls separating *sleeping units* in Group R-1 shall
20 be permitted without automatic- or *self-closing* devices.
- 21 2. The elevator car doors and the associated hoistway enclosure doors at the floor
22 level designated for recall in accordance with ((Section 3003.2)) Chapter 30 shall
23 be permitted to remain open during Phase I emergency recall operation.

1 3. In Group I-1, Condition 2 Assisted living facilities licensed under chapter 388-
2 78A WAC and residential treatment facilities licensed under chapter 246-337
3 WAC, fire doors in dwelling and sleeping units opening to the corridor shall be
4 permitted without automatic or self-closing devices when all of the following
5 conditions exist:

6 3.1 Each floor is constantly attended by staff on a 24-hour basis and stationed on
7 that floor;

8 3.2 The facility is provided with an NFPA 13 sprinkler system throughout;

9 3.3 Doors shall be equipped with positive latching;

10 3.4 Dwelling and sleeping units are not equipped with cooking appliances;

11 3.5 Dwelling and sleeping units shall be equipped with a smoke detection system
12 interconnected with the smoke detection system required by Section
13 907.2.6.1.

14 ***

15 **716.5.9.3 Smoke-activated doors.** Automatic-closing doors installed in the following
16 locations shall be automatic-closing by the actuation of smoke detectors installed in
17 accordance with Section 907.3 or by loss of power to the smoke detector or hold-open
18 device. Doors that are automatic-closing by smoke detection shall not have more than a
19 10-second delay before the door starts to close after the smoke detector is actuated:

- 20 1. Doors installed across a *corridor*.
21 2. Doors installed in the enclosures of *exit access stairways* and *ramps* in accordance
22 with Sections 1019 and 1023, respectively.

- 1 3. Doors that protect openings in *exits* or *corridors* required to be of *fire-resistance-*
- 2 *rated* construction.
- 3 4. Doors that protect openings in walls that are capable of resisting the passage of
- 4 smoke in accordance with Section 509.4.
- 5 5. Doors installed in *smoke barriers* in accordance with Section 709.5.
- 6 6. Doors installed in *fire partitions* in accordance with Section 708.6.
- 7 7. Doors installed in a *fire wall* in accordance with Section 706.8.
- 8 8. Doors installed in *shaft enclosures* in accordance with Section 713.7.
- 9 9. Doors installed in waste and linen chutes, discharge openings and access and
- 10 discharge rooms in accordance with Section 713.13. Loading doors installed in
- 11 waste and linen chutes shall meet the requirements of Sections 716.5.9 and
- 12 716.5.9.1.1.
- 13 10. Doors installed in the walls for compartmentation of underground buildings in
- 14 accordance with Section 405.4.2.
- 15 11. Doors installed in the elevator lobby walls of underground buildings in
- 16 accordance with Section 405.4.3.
- 17 12. Doors installed in smoke partitions in accordance with Section 710.5.2.3.
- 18 13. Additional doors provided at elevator hoistway door openings installed in
- 19 accordance with Section 713.14.3 item 3.

20 ***

21 **SECTION 717**

22 **DUCTS AND AIR TRANSFER OPENINGS**

23 ***

1 **717.3.3 Damper actuation.** *Damper* actuation shall be in accordance with Sections 717.3.3.1
2 through 717.3.3.5 as applicable.

3 **717.3.3.1 Fire damper actuation device.** The *fire damper* actuation device shall meet
4 one of the following requirements:

- 5 1. The operating temperature shall be approximately 50°F (10°C) above the normal
6 temperature within the duct system, but not less than 160°F (71°C).
- 7 2. The operating temperature shall be not more than 350°F (177°C) where located in a
8 smoke control system complying with Section 909.

9 **Interpretation I717.3:** Dampers associated with exhaust fans used for hoistway and
10 stair pressurization are permitted to comply with Section 717.3.3.1, item 2.

11 ***

12 **717.5.3 Shaft enclosures.** Shaft enclosures that are permitted to be penetrated by ducts and
13 air transfer openings shall be protected with *approved* fire and smoke *dampers* installed in
14 accordance with their listing.

15 **Exceptions:**

16 1. *Fire dampers* are not required at penetrations of shafts where any of the following
17 criteria are met:

18 1.1. Steel exhaust subducts are extended not less than 22 inches (559 mm)
19 vertically in exhaust shafts, provided there is a continuous airflow upward to
20 the outside.

21 1.2. Penetrations are tested in accordance with ASTM E 119 or UL 263 as part of
22 the *fire-resistance-rated* assembly.

1 1.3. Ducts are used as part of an *approved* smoke control system designed and
2 installed in accordance with Section 909 and where the *fire damper* will
3 interfere with the operation of the smoke control system.

4 1.4. The penetrations are in parking garage exhaust or supply shafts that are
5 separated from other building shafts by not less than 2-hour *fire-resistance-*
6 *rated* construction.

7 2. In Group B and R occupancies equipped throughout with an *automatic sprinkler*
8 *system* in accordance with Section 903.3.1.1, *smoke dampers* are not required at
9 penetrations of shafts where all of the following criteria are met:

10 2.1. Kitchen, clothes dryer, bathroom, ~~((and))~~ toilet room, accessory storage, and
11 accessory trash room exhaust openings are installed with steel exhaust
12 subducts, having a minimum wall thickness of 0.0187-inch (0.4712 mm) (No.
13 26 gage).

14 2.2. The subducts extend not less than 22 inches (559 mm) vertically.

15 2.3. An exhaust fan is installed at the upper terminus of the shaft that is ~~((powered~~
16 ~~continuously in accordance with the provisions of Section 909.11,))~~ provided
17 with a legally required standby power system in accordance with Seattle
18 Electrical Code Section 701 so as to maintain a continuous upward airflow to
19 the outside.

20 3. *Smoke dampers* are not required at penetration of exhaust or supply shafts in
21 parking garages that are separated from other building shafts by not less than 2-
22 hour *fire-resistance-rated* construction.

1 4. *Smoke dampers* are not required at penetrations of shafts where ducts are used as
2 part of an *approved* mechanical smoke control system designed in accordance with
3 Section 909 and where the *smoke damper* will interfere with the operation of the
4 smoke control system.

5 5. *Fire dampers* and *combination fire/smoke dampers* are not required in kitchen and
6 clothes dryer exhaust systems where ~~((installed in accordance with))~~ dampers are
7 prohibited by the *International Mechanical Code*.

8 ***

9 **SECTION 718**

10 **CONCEALED SPACES**

11 ***

12 **718.3.2 Groups R-1, R-2, and R-3 ~~((and R-4))~~.** *Draftstopping* shall be provided in
13 floor/ceiling spaces in Group R-1 buildings, in Group R-2 buildings with three or more
14 *dwelling units*, and in Group R-3 buildings with two *dwelling units* ~~((and in Group R-4~~
15 ~~buildings))~~. *Draftstopping* shall be located above and in line with the *dwelling unit* and
16 *sleeping unit* separations.

17 **Exceptions:**

18 1. *Draftstopping* is not required in buildings equipped throughout with an *automatic*
19 *sprinkler system* in accordance with Section 903.3.1.1.

20 2. *Draftstopping* is not required in buildings equipped throughout with an *automatic*
21 *sprinkler system* in accordance with Section 903.3.1.2, provided that automatic
22 sprinklers are installed in the combustible concealed spaces where the *draftstopping*
23 is being omitted.

1 ***

2 **718.5 Combustible materials in concealed spaces in Type I or II construction.** Combustible
3 materials shall not be permitted in concealed spaces of *buildings* of Type I or II construction.

4 **Exceptions:**

- 5 1. Combustible materials in accordance with Section 603.
- 6 2. Combustible materials exposed within plenums complying with Section 602 of the
7 *International Mechanical Code*.
- 8 3. Class A *interior finish* materials classified in accordance with Section 803.
- 9 4. Combustible piping within partitions or shaft enclosures installed in accordance with
10 the provisions of this code.
- 11 5. Combustible piping within concealed ceiling spaces installed in accordance with the
12 *International Mechanical Code* and the (~~*International*~~) *Uniform Plumbing Code*.
- 13 6. Combustible insulation and covering on pipe and tubing, installed in concealed spaces
14 other than plenums, complying with Section 720.7.

15 ***

16 Section 9. The following sections of Chapter 9 of the International Building Code, 2015
17 Edition, are amended as follows:

18 **CHAPTER 9**

19 **FIRE PROTECTION SYSTEMS**

20
21 **SECTION 901**

22 **GENERAL**

23 ***

1 **901.2 Fire protection systems.** Fire protection systems shall be installed, repaired, operated and
2 maintained in accordance with this code and the *International Fire Code*.

3 Any *fire protection system* for which an exception or reduction to the provisions of this code
4 has been granted shall be considered to be a required system.

5 **Exception:** Any fire protection system or portion thereof not required by this code shall be
6 permitted to be installed for partial or complete protection provided that such system meets the
7 requirements of this code.

8 **901.2.1 Certificates required.** Individuals who install, inspect, test or maintain fire protection
9 systems shall obtain the proper certificate from the fire code official as required by the
10 *International Fire Code*.

11 ***

12 **901.5 Acceptance tests.** Fire protection systems shall be tested in accordance with the
13 requirements of this code and the International Fire Code. When required, the tests shall be
14 conducted in the presence of the building official. Tests required by this code, the International
15 Fire Code and the standards listed in this code shall be conducted at the expense of the owner or
16 the owner's authorized agent. It shall be unlawful to occupy portions of a structure until the
17 systems required by this code and the International Fire Code (~~fire protection systems~~) within
18 that portion of the structure have been tested and approved.

19 ***

20 **901.6.2 Fire alarm systems.** Fire alarm systems required by the provisions of Section 907.2
21 of this code and Sections 907.2 and 907.9 of the *International Fire Code* shall be monitored
22 by an approved supervising station in accordance with Section 907.6.6.

23 **Exceptions:**

- 1 1. Single- and multiple-station smoke alarms required by Section 907.2.11.
- 2 2. Smoke detectors in Group I-3 occupancies.
- 3 3. Supervisory service is not required for *automatic sprinkler systems* in one- and two-
- 4 family dwellings and townhouses.

5 ***

6 SECTION 902

7 DEFINITIONS

8 **902.1 Definitions.** The following terms are defined in Chapter 2:

9 ***

10 **[F] FIRE DETECTION SYSTEM.**

11 ***

12 **[W] PORTABLE SCHOOL CLASSROOM.**

13 ***

14 **REPAIR GARAGE.**

15 **Major Repair Garage**

16 **Minor Repair Garage**

17 ***

18 **TOWNHOUSE.**

19 ***

20 SECTION 903

21 AUTOMATIC SPRINKLER SYSTEMS

22 ***

1 [F] 903.2.1.2 Group A-2. An automatic sprinkler system shall be provided for fire areas
2 containing Group A-2 occupancies and intervening floors of the building where one of the
3 following conditions exists:

- 4 1. The *fire area* exceeds 5,000 square feet (464.5 m²).
- 5 2. The *fire area* has an occupant load of 100 or more.
- 6 3. The *fire area* is located on a floor other than a level of exit discharge serving such
7 occupancies.

8 **Exception:** Item 3 does not apply to fire areas that include space located one floor above
9 the level of exit discharge if the occupant load of the upper floor is less than 50.

10 ***

11 **[W] [F] 903.2.1.6 Assembly occupancies on roofs.** Where an occupied roof has an assembly
12 occupancy with an occupant load exceeding 100 for Group A-2 and 300 for other Group A
13 occupancies, ~~((all floors between the occupied roof and the *level of exit discharge*))~~ the
14 building shall be equipped with an *automatic sprinkler system* in accordance with Section
15 903.3.1.1 or 903.3.1.2.

16 **Exception:** Open parking garages of Type I or Type II construction.

17 ***

18 **[W] [F] 903.2.3 Group E.** An *automatic sprinkler system* shall be provided for Group E
19 ~~((occupancies))~~ fire areas. ~~((as follows:~~

- 20 1. Throughout all Group E fire areas greater than 12,000 square feet (1115 m²) in area.
- 21 2. Throughout every portion of educational buildings below the lowest *level of exit*
22 *discharge* serving that portion of the building.

1 **Exception:** ~~An automatic sprinkler system is not required in any area below the lowest~~
2 ~~level of exit discharge serving that area where every classroom throughout the building~~
3 ~~has not fewer than one exterior exit door at ground level.)~~)

4 **Exceptions:**

5 1. Portable school classrooms with an occupant load of 50 or less calculated in
6 accordance with Table 1004.1.2, if the aggregate area of any cluster of portable
7 school classrooms does not exceed 6,000 square feet (557 m²); and clusters of
8 portable school classrooms shall be separated as required in Chapter 5.

9 2. Portable school classrooms with an occupant load from 51 through 98, calculated in
10 accordance with Table 1004.1.2, and provided with two means of direct independent
11 exterior egress from each classroom in accordance with Chapter 10, and one exit from
12 each classroom shall be accessible, provided that the aggregate area of any cluster of
13 portable classrooms does not exceed 6,000 square feet (557 m²), and clusters of
14 portable school classrooms shall be separated as required by Chapter 5.

15 3. Group E occupancies with an occupant load of 50 or less within the Group E
16 occupancy, calculated in accordance with Table 1004.1.2.

17 4. Group E daycare and preschool facilities with an occupant load of 100 or less, when
18 located at the level of exit discharge, where every room in which care is provided has
19 not fewer than one exterior exit door.

20 ***

21 **[W] [F] 903.2.6 Group I.** An automatic sprinkler system shall be provided throughout
22 buildings with a Group I fire area.

23 **Exceptions:**

- 1 1. An automatic sprinkler system installed in accordance with Section 903.3.1.2 shall be
2 permitted in Group I-1 Condition 1 facilities.
- 3 2. An *automatic sprinkler* system is not required (~~((where))~~) in Group I-4 day care facilities
4 with an occupant load of 100 or less (~~((are))~~) when located at the level of exit discharge
5 and where every room where care is provided has not fewer than one exterior exit door.
- 6 3. In buildings where Group I-4 day care is provided on levels other than the *level of exit*
7 *discharge*, an *automatic sprinkler system* in accordance with Section 903.3.1.1 shall be
8 installed on the entire floor where care is provided, all floors between the level of care
9 and the *level of exit discharge*, and all floors below the *level of exit discharge* other than
10 areas classified as an open parking garage.
- 11 4. Where new construction or additions house less than sixteen persons receiving care, an
12 automatic sprinkler system installed in accordance with Section 903.2.8.3 shall be
13 permitted for Group I-1, condition 2, assisted living facilities licensed under chapter
14 388-78A WAC and residential treatment facilities licensed under chapter 246-337
15 WAC.

16 ***

17 **[W] [F] 903.2.8 Group R.** An *automatic sprinkler system* installed in accordance with Section
18 903.3 shall be provided throughout all buildings with a Group R fire area.

19 **Exception:** Group R-1 if all of the following conditions apply:

- 20 1. The Group R *fire area* is no more than 500 square feet and is used for recreational use
21 only.
- 22 2. The Group R fire area is on only one story.
- 23 3. The Group R fire area does not include a basement.

1 4. The Group R fire area is no closer than 30 feet from another structure.

2 5. Cooking is not allowed within the Group R fire area.

3 6. The Group R fire area has an occupant load of no more than 8.

4 7. A hand-held (portable) fire extinguisher is in every Group R fire area.

5 **[F] 903.2.8.1 Group R-3.** *An automatic sprinkler system installed in accordance with*
6 *Section 903.3.1.3 shall be permitted in Group R-3 occupancies.*

7 ~~**[W] (([F] 903.2.8.2 Group R-4 Condition 1.** *An automatic sprinkler system installed in*~~
8 ~~*accordance with Section 903.3.1.3 shall be permitted in Group R-4 Condition 1 occupancies.*~~

9 ~~**[F] 903.2.8.3 Group R-4 Condition 2.** *An automatic sprinkler system installed in*~~
10 ~~*accordance with Section 903.3.1.2 shall be permitted in Group R-4 Condition 2 occupancies.*~~

11 ~~*Attics shall be protected in accordance with Section 903.2.8.3.1 or 903.2.8.3.2.*~~

12 ~~**[F] 903.2.8.3.1 Attics used for living purposes, storage or fuel-fired equipment.** *Attics*~~
13 ~~*used for living purposes, storage or fuel-fired equipment shall be protected throughout with*~~
14 ~~*an automatic sprinkler system installed in accordance with Section 903.3.1.2.*~~

15 ~~**[F] 903.2.8.3.2 Attics not used for living purposes, storage or fuel-fired equipment.**~~
16 ~~*Attics not used for living purposes, storage or fuel-fired equipment shall be protected in*~~
17 ~~*accordance with one of the following:*~~

18 ~~—1. Attics protected throughout by a heat detector system arranged to activate the~~
19 ~~building fire alarm system in accordance with Section 907.2.10.~~

20 ~~—2. Attics constructed of noncombustible materials.~~

21 ~~—3. Attics constructed of fire retardant-treated wood framing complying with Section~~
22 ~~2303.2.~~

1 **Exception:** Sprinkler protection is not required underneath the building when the space
2 is separated from the adjacent space by construction resisting the passage of smoke and
3 heat and combustible storage will not be located there.

4 ***

5 **[F] 903.3.1 Standards.** Sprinkler systems shall be designed and installed in accordance with
6 Section 903.3.1.1 and rules promulgated by the building or fire code official unless otherwise
7 permitted by Sections 903.3.1.2 and 903.3.1.3 and other chapters of this code, as applicable.

8 **[F] 903.3.1.1 NFPA 13 sprinkler systems.** Where the provisions of this code require that a
9 building or portion thereof be equipped throughout with an *automatic sprinkler system* in
10 accordance with this section, sprinklers shall be installed throughout in accordance with
11 NFPA 13 except as provided in Sections 903.3.1.1.1 and 903.3.1.1.2.

12 **[F] 903.3.1.1.1 Exempt locations.** Automatic sprinklers shall not be required in the
13 following rooms or areas where such rooms or areas are protected with an approved
14 automatic fire detection system in accordance with Section 907.2 that will respond to
15 visible or invisible particles of combustion. Sprinklers shall not be omitted from a room
16 merely because it is damp, of fire-resistance-rated construction or contains electrical
17 equipment.

- 18 1. A room where the application of water, or flame and water, constitutes a serious life or
19 fire hazard, when approved by the fire code official.
- 20 2. A room or space where sprinklers are considered undesirable because of the nature of
21 the contents, where approved by the fire code official.

1 3. ~~((Generator and transformer rooms))~~ Transformer vaults separated from the remainder
2 of the building by walls and floor/ceiling or roof/ceiling assemblies having a fire-
3 resistance rating of not less than ~~((2))~~ 3 hours.

4 4. Rooms or areas that are of noncombustible construction with wholly noncombustible
5 contents.

6 5. ~~((Fire service access elevator machine rooms and machinery spaces,~~
7 6.)) Machine rooms, machinery spaces, control rooms and control spaces in
8 accordance with rules promulgated by the building and fire code official. ~~((associated~~
9 with occupant evacuation elevators designed in accordance with Section 3008.))

10 **[F] 903.3.1.1.2 Bathrooms.** In Group R occupancies, other than Group R-4 occupancies,
11 sprinklers shall not be required in bathrooms that do not exceed 55 square feet (5 m²) in
12 area and are located within individual dwelling units or sleeping units, provided that walls
13 and ceilings, including the walls and ceilings behind a shower enclosure or tub, are of non-
14 combustible or limited-combustible materials with a 15-minute thermal barrier rating.

15 **903.3.1.1.3 High-rise building sprinkler system design.** High-rise building sprinkler
16 systems shall be combination standpipe/sprinkler systems incorporating the following
17 features:

- 18 1. Each floor sprinkler system shall be connected between standpipe risers.
- 19 2. Shut-off valves, water-flow devices and check valves (or pressure reducing valves)
20 shall be provided on each floor at the sprinkler system connection to each standpipe.
- 21 3. Two four-way fire department connections serving the combination system shall be
22 provided on separate streets well separated from each other.

1 4. At least one of the fire department connections shall be connected to the riser above a
2 riser isolation valve.

3 5. When a mid-level fire pump is required to meet pressure requirements, two pumps
4 with the same rating shall be installed.

5 6. Dry-pipe sprinkler systems serving parking garages may use separate two-way fire
6 department connection. The dry-pipe sprinkler system shall be supplied by the on-site
7 water tank.

8 7. The standpipe risers in each required stair shall be a minimum pipe size of 6 inches
9 (152 mm).

10 8. Two 2½ -inch (64 mm) hose connections shall be provided on every floor level
11 landing in every required stairway. If pressure reducing valves (PRV) are required,
12 each hose connection shall be provided with its own PRV.

13 9. The system shall be designed to provide a minimum flow of 300 gpm (19 L/s) at a
14 minimum pressure of 150 psi (1034 kPa) [maximum 205 psi (1379 kPa)] at each
15 standpipe connection in addition to the flow and pressure requirements contained in
16 NFPA 14.

17 10. When a mid-level pump is required to meet pressure requirements, two mid-level
18 pumps with the same rating shall be provided.

19 **[F] 903.3.1.2 NFPA 13R sprinkler systems.** Automatic sprinkler systems in Group R
20 occupancies up to and including four stories in height in buildings not exceeding 60 feet
21 (18288 mm) in height above grade plane shall be permitted to be installed throughout in
22 accordance with NFPA 13R.

1 The number of stories of Group R occupancies constructed in accordance with Sections
2 510.2 and 510.4 shall be measured from the horizontal assembly creating separate buildings.

3 **[F] 903.3.1.2.1 Balconies and decks.** Sprinkler protection shall be provided for exterior
4 balconies, decks and ground floor patios of dwelling units and sleeping units in accordance
5 with rules promulgated by the building official or fire code official. ~~((where))~~ Where the
6 building is of Type V construction, provided there is a roof or deck above. Sidewall
7 sprinklers that are used to protect such areas shall be permitted to be located such that their
8 deflectors are within 1 inch (25 mm) to 6 inches (152 mm) below the structural members
9 and a maximum distance of 14 inches (356 mm) below the deck of the exterior balconies
10 and decks that are constructed of open wood joist construction.

11 **[F] 903.3.1.2.2 Open-ended corridors.** Sprinkler protection shall be provided in open-
12 ended corridors and associated exterior stairways and ramps as specified in Section 1027.6,
13 Exception 3.

14 **[F] 903.3.1.3 NFPA 13D sprinkler systems.** Automatic sprinkler systems installed in one-
15 and two-family dwellings; Group R-3, ~~((Group R-4 Condition 1))~~ and townhouses, when
16 approved by the fire code official, shall be permitted to be installed throughout in accordance
17 with NFPA 13D.

18 ***

19 **[F] 903.3.3 Obstructed locations.** Automatic sprinklers shall be installed ~~((with due regard to~~
20 ~~obstructions that will delay activation or obstruct the water distribution pattern))~~ in accordance
21 with NFPA 13 obstruction criteria and the listing requirements of the sprinkler. Automatic
22 sprinklers shall be installed in or under covered kiosks, displays, booths, concession stands, or
23 equipment that exceeds 4 feet (1219 mm) in width and depth. Not less than a 3-foot (914 mm)

1 clearance shall be maintained between automatic sprinklers and the top of piles of combustible
2 fibers.

3 **Exception:** Kitchen equipment under exhaust hoods protected with a fire-extinguishing
4 system in accordance with Section 904.

5 [F] **903.3.4 Actuation.** Automatic sprinkler systems shall be automatically actuated unless
6 specifically provided for in this code.

7 [F] **903.3.5 Water supplies.** Water supplies for automatic sprinkler systems shall comply with
8 this section and the standards referenced in Section 903.3.1. The potable water supply shall be
9 protected against backflow in accordance with the requirements of this section and the
10 ~~((*International*)) Uniform Plumbing Code~~. For connections to public waterworks systems, the
11 water supply test data provided by Seattle Public Utilities and used for design of fire protection
12 systems shall be adjusted in accordance with rules promulgated by the fire code official. ~~((to
13 account for seasonal and daily pressure fluctuations based on information from the water
14 supply authority and as approved by the fire code official.))~~

15 [F] **903.3.5.1 Domestic services.** Where the domestic service provides the water supply for
16 the automatic sprinkler system, the supply shall be in accordance with this section.

17 **903.3.5.2 ~~((Residential combination))~~ Combined fire/domestic services.** A single
18 combination water supply shall be allowed for all types of sprinkler systems provided that,
19 when required, the domestic demand is added to the sprinkler demand ~~((as required by))~~ in
20 accordance with the domestic demand tables in NFPA 13R.

21 **[W] 903.3.5.3 Underground portions of fire protection system water supply piping.**

22 The installation or modification of an underground water main, public or private, supplying
23 a water-based fire protection system shall be in accordance with NFPA 24 and RCW

1 6. Valves controlling the fuel supply to fire pump engines that are sealed or locked in the
2 open position.

3 7. Trim valves to pressure switches in dry, preaction and deluge sprinkler systems that are
4 sealed or locked in the open position.

5 **[F] 903.4.1 Monitoring.** Alarm, supervisory and trouble signals shall be distinctly different
6 and shall be automatically transmitted to an approved supervising station or, where approved
7 by the fire code official, shall sound an audible signal at a constantly attended location.

8 **Exceptions:**

9 1. (~~Underground key or hub valves in roadway boxes~~) Valves provided by the
10 municipality or public utility are not required to be monitored.

11 2. Backflow prevention device test valves located in limited area sprinkler system supply
12 piping shall be locked in the open position. In occupancies required to be equipped
13 with a fire alarm system, the backflow preventer valves shall be electrically supervised
14 by a tamper switch installed in accordance with NFPA 72 and separately annunciated.

15 ***

16 **SECTION 904**

17 **ALTERNATIVE AUTOMATIC FIRE-EXTINGUISHING SYSTEMS**

18 ***

19 **[F] 904.3.1 Electrical wiring.** Electrical wiring shall be in accordance with (~~NFPA 70~~) the
20 Seattle Electrical Code.

21 ***

22 **[W][F] 904.12 Commercial cooking systems.** The automatic fire-extinguishing system for
23 commercial cooking systems shall be of a type recognized for protection of commercial cooking

1 equipment and exhaust systems of the type and arrangement protected. Preengineered automatic
2 dry- and wet-chemical extinguishing systems shall be tested in accordance with UL 300 and
3 listed and labeled for the intended application. Other types of automatic fire-extinguishing
4 systems shall be listed and labeled for specific use as protection for commercial cooking
5 operations. The system shall be installed in accordance with this code, its listing and the
6 manufacturer's installation instructions. Signage shall be provided on the exhaust hood or system
7 cabinet, indicating the type and arrangement of cooking appliances protected by the automatic
8 fire extinguishing system. Signage shall indicate appliances from left to right, be durable, and
9 the size, color and lettering shall be approved. Automatic fire-extinguishing systems of the
10 following types shall be installed in accordance with the referenced standard indicated, as
11 follows:

- 12 1. Carbon dioxide extinguishing systems, NFPA 12.
- 13 2. *Automatic sprinkler systems*, NFPA 13.
- 14 3. Foam-water sprinkler system or foam-water spray systems, NFPA 16.
- 15 4. Dry-chemical extinguishing systems, NFPA 17.
- 16 5. Wet-chemical extinguishing systems, NFPA 17A.

17 **Exception:** Factory-built commercial cooking recirculating systems that are tested in
18 accordance with UL 710B and listed, labeled and installed in accordance with Section 304.1 of
19 the *International Mechanical Code*.

20 ***

21 SECTION 905

22 STANDPIPE SYSTEMS

23 ***

1 **[F] 905.2 Installation standard.** Standpipe systems shall be installed in accordance with this
2 section, ~~((and))~~ NFPA 14 and rules promulgated by the building or fire code official. Fire
3 department connections for standpipe systems shall be in accordance with Section 912.

4 **[F] 905.3 Required installations.** Standpipe systems shall be installed where required by
5 Sections 905.3.1 through 905.3.8. Standpipe systems are allowed to be combined with automatic
6 sprinkler systems.

7 **Exception:** Standpipe systems are not required in ~~((Group R-3 occupancies))~~ one- and two-
8 family dwellings and townhouses.

9 ***

10 **[F] 905.3.3 Covered and open mall buildings.** Covered mall and open mall buildings shall be
11 equipped throughout with a Class I standpipe system ~~((where required by Section 905.3.1.~~
12 ~~Mall buildings not required to be equipped with a standpipe system by Section 905.3.1 shall be~~
13 ~~equipped with Class I hose connections connected to the automatic sprinkler system sized to~~
14 ~~deliver water at 250 gallons per minute (946.4 L/min) at the most hydraulically remote hose~~
15 ~~connection while concurrently supplying the automatic sprinkler system demand. The~~
16 ~~standpipe system shall be designed to not exceed a 50 pounds per square inch (psi) (345 kPa)~~
17 ~~residual pressure loss with a flow of 250 gallons per minute (946.4 L/min) from the fire~~
18 ~~department connection to the hydraulically most remote hose connection. Hose))~~ with hose
19 connections ~~((shall be))~~ provided at each of the following locations:

- 20 1. Within the mall at the entrance to each exit passageway or *corridor*.
- 21 2. At each floor-level landing within interior exit stairways opening directly on the mall.
- 22 3. At exterior public entrances to the mall of a covered mall building.
- 23 4. At public entrances at the perimeter line of an open mall building.

1 5. At other locations as necessary so that the distance to reach all portions of a tenant space
2 does not exceed 200 feet (60960 mm) from a hose connection.

3 ~~(([F] 905.3.4 Stages. Stages greater than 1,000 square feet in area (93 m²) shall be equipped
4 with a Class III wet standpipe system with 1 ½-inch and 2 ½-inch (38 mm and 64 mm) hose
5 connections on each side of the stage.~~

6 ~~**Exception:** Where the building or area is equipped throughout with an automatic sprinkler
7 system, a 1 ½-inch (38 mm) hose connection shall be installed in accordance with NFPA 13
8 or in accordance with NFPA 14 for Class II or III standpipes.~~

9 ~~**[F] 905.3.4.1 Hose and cabinet.** The 1 ½-inch (38 mm) hose connections shall be equipped
10 with sufficient lengths of 1 ½-inch (38 mm) hose to provide fire protection for the stage area.
11 Hose connections shall be equipped with an approved adjustable fog nozzle and be mounted
12 in a cabinet or on a rack.))~~

13 **[F] 905.3.4((5)) Underground buildings.** Underground buildings shall be equipped
14 throughout with a Class I automatic wet or manual wet standpipe system.

15 **[F] 905.3.5((6)) Helistops and heliports.** Buildings with a rooftop helistop or heliport shall be
16 equipped with a Class I or III standpipe system extended to the roof level on which the helistop
17 or heliport is located in accordance with Section 2007.5 of the *International Fire Code*.

18 **[F] 905.3.6((7)) Marinas and boatyards.** Standpipes in marinas and boatyards shall comply
19 with Chapter 36 of the *International Fire Code*.

20 **[F] 905.3.7((8)) Rooftop gardens and landscaped roofs.** Buildings or structures that have
21 rooftop gardens or landscaped roofs and that are equipped with a standpipe system shall have
22 the standpipe system extended to the roof level on which the rooftop garden or landscaped roof
23 is located.

1 **[F] 905.4 Location of Class I standpipe hose connections.** Class I standpipe hose connections
2 shall be provided in all of the following locations:

3 1. In every required interior exit stairway, a hose connection shall be provided for each story
4 above and below grade. Hose connections shall be located at an intermediate landing
5 between stories, or the main landing at each story, but must be consistent throughout a
6 building (~~unless otherwise approved by the fire code official~~).

7 2. On each side of the wall adjacent to the exit opening of a horizontal exit.

8 **Exception:** Where floor areas adjacent to a horizontal exit are reachable from an interior
9 exit stairway hose connection by a 30-foot (9144 mm) hose stream from a nozzle attached
10 to 100 feet (30 480 mm) of hose, a hose connection shall not be required at the horizontal
11 exit.

12 3. In every exit passageway, at the entrance from the exit passageway to other areas of a
13 building.

14 **Exception:** Where floor areas adjacent to an exit passageway are reachable from an interior
15 exit stair- way hose connection by a 30-foot (9144 mm) hose stream from a nozzle attached
16 to 100 feet (30 480 mm) of hose, a hose connection shall not be required at the entrance
17 from the exit passageway to other areas of the building.

18 4. In covered mall buildings, adjacent to each exterior public entrance to the mall and
19 adjacent to each entrance from an exit passageway or exit corridor to the mall. In open
20 mall buildings, adjacent to each public entrance to the mall at the perimeter line and
21 adjacent to each entrance from an exit passageway or exit corridor to the mall.

22 5. Where the roof has a slope less than four units vertical in 12 units horizontal (33.3-percent
23 slope), a hose connection shall be located to serve the roof or at the highest landing of an

1 interior exit stairway with access to the roof provided in accordance with Section 1011.12.
2 Hose connections on a roof shall be at least 10 feet (3048 mm) from the roof edge,
3 skylight, light well or other opening, unless protected by an *approved* 42-inch-high (1067
4 mm) guard or equivalent.

- 5 6. Where the most remote portion of a nonsprinklered floor or *story* is more than 150 feet (45
6 720 mm) from a hose connection or the most remote portion of a sprinklered floor or story
7 or roof is more than 200 feet (60 960 mm) from a hose connection, the fire code official is
8 authorized to require that additional hose connections be provided in *approved* locations.
9 Access to the additional hose connections shall be through protected enclosures. The
10 protected enclosure shall be a corridor constructed as a smoke barrier from the interior exit
11 stairway to the standpipe connection. Additional hose connections in parking garages and
12 roofs are not required to be accessed through or located in protected enclosures.

13 ***

14 **[F] 905.5 Location of Class II standpipe hose connections.** Class II standpipe hose
15 connections shall be accessible and located so that all portions of the building are within 30 feet
16 (9144 mm) of a nozzle attached to 100 feet (30 480 mm) of hose.

17 ~~((**[F] 905.5.1 Groups A-1 and A-2.** In Group A-1 and A-2 occupancies having occupant loads
18 exceeding 1,000 persons, hose connections shall be located on each side of any stage, on each
19 side of the rear of the auditorium, on each side of the balcony and on each tier of dressing
20 rooms.))~~

21 **[F] 905.5.1((2)) Protection.** Fire-resistance-rated protection of risers and laterals of Class II
22 standpipe systems is not required.

1 [F] 905.5.2((3)) **Class II system 1-inch hose.** A minimum 1-inch (25 mm) hose shall be
2 allowed to be used for hose stations in light-hazard occupancies where investigated and listed
3 for this service and where approved by the fire code official.

4 ***

5 [F] 905.9 **Valve supervision.** Valves controlling water supplies shall be supervised in the open
6 position so that a change in the normal position of the valve will generate a supervisory signal at
7 the supervising station required by Section 903.4. Where a fire alarm system is provided, a signal
8 shall be transmitted to the control unit.

9 **Exceptions:**

- 10 1. Valves ((to underground key or hub valves in roadway boxes)) provided by the
11 municipality or public utility do not require supervision.
- 12 2. Valves locked in the normal position and inspected as provided in this code in buildings
13 not equipped with a fire alarm system or approved supervising station.

14 ***

15 **SECTION 907**

16 **FIRE ALARM AND DETECTION SYSTEMS**

17 [F] 907.1 **General.** This section covers the application, installation, performance and
18 maintenance of fire alarm systems and their components. Buildings required by this section to be
19 provided with a fire alarm system shall be provided with a single fire alarm system. For the
20 purposes of this section, *fire walls* not located on a property line shall not constitute a separate
21 building.

1 **Exception:** A single system is not required in existing buildings that are being increased in size
2 and the existing fire alarm system is unable to expand into the new space. In those cases
3 multiple systems shall be arranged as described below for nonrequired fire alarm systems.

4 Buildings not required by this section to be provided with a fire alarm system may be provided
5 with multiple partial fire alarm systems if:

- 6 1. The systems are connected so that all systems simultaneously activate alarm notification
7 appliances upon a signal from any of the fire alarm systems in the building, and
- 8 2. The location of each system's annunciator panel (or main panel) is also provided with
9 annunciator panels with reset capability for every other system in the building.

10 **[F] 907.1.1 Construction documents.** Construction documents for fire alarm systems shall be
11 of sufficient clarity to indicate the location, nature and extent of the work proposed and show
12 in detail that it will conform to the provisions of this code, the *International Fire Code* and
13 relevant laws, ordinances, rules and regulations, as determined by the fire code official.

14 **[F] 907.1.2 Fire alarm shop drawings.** All construction documents shall be reviewed by a
15 NICET III or IV in fire alarms or a professional engineer licensed in the state of Washington
16 prior to being submitted for permitting. The reviewing professional shall submit a stamped,
17 signed and dated letter; or a verification method approved by the fire code official indicating
18 the system has been reviewed and meets or exceeds the design requirements of the State of
19 Washington and the fire code official.

20 Shop drawings for fire alarm systems shall be submitted for review and approval prior to
21 system installation, and shall include, but not be limited to, all of the following where
22 applicable to the system being installed:

- 23 1. A floor plan that indicates the use of all rooms.

- 1 2. Locations of alarm-initiating devices.
- 2 3. Locations of alarm notification appliances, including candela ratings for visible alarm
- 3 notification appliances.
- 4 4. Design minimum audibility level for occupant notification.
- 5 5. Location of fire alarm control unit, transponders and notification power supplies.
- 6 6. Annunciators.
- 7 7. Power connection.
- 8 8. Battery calculations.
- 9 9. Conductor type and sizes.
- 10 10. Voltage drop calculations.
- 11 11. Manufacturers' data sheets indicating model numbers and listing information for
- 12 equipment, devices and materials.
- 13 12. Details of ceiling height and construction.
- 14 13. The interface of fire safety control functions.
- 15 14. Classification of the supervising station.

16 **907.1.3 Equipment.** Systems and components shall be *listed* and *approved* for the purpose for
17 which they are installed.

18 ***

19 **[W] [F] 907.2.3 Group E.** A manual fire alarm system that initiates the occupant notification
20 signal utilizing an emergency voice/alarm communication system meeting the requirements of
21 Section 907.5.2.2 and installed in accordance with Section 907.6 shall be installed in Group E
22 occupancies. When automatic sprinkler systems or smoke detectors are installed, such systems
23 or detectors shall be connected to the building fire alarm system.

1 **Exceptions:**

- 2 1. A manual fire alarm system is not required in Group E occupancies with an occupant
3 load of 50 or less.
- 4 2. Emergency voice/alarm communication systems meeting the requirements of Section
5 907.5.2.2 and installed in accordance with Section 907.6 shall not be required in
6 Group E occupancies with occupant loads of 100 or less, provided that activation of
7 the manual fire alarm system initiates an approved occupant notification signal in
8 accordance with Section 907.5.
- 9 3. Manual fire alarm boxes are not required in Group E occupancies where all of the
10 following apply:
- 11 3.1. Interior corridors are protected by smoke detectors.
- 12 3.2. Auditoriums, cafeterias, gymnasiums and similar areas are protected by heat
13 detectors or other approved detection devices.
- 14 3.3. Shops and laboratories involving dusts or vapors are protected by heat detectors
15 or other approved detection devices.
- 16 4. Manual fire alarm boxes shall not be required in Group E occupancies where all of the
17 following apply:
- 18 4.1. The building is equipped throughout with an approved automatic sprinkler system
19 installed in accordance with Section 903.3.1.1.
- 20 4.2. The emergency voice/alarm communication system will activate on sprinkler
21 waterflow and manual activation.
- 22 (~~4.3. Manual activation is provided from a normally occupied location.~~)

23 ***

1 [F] 907.2.6.1 Group I-1. In Group I-1 occupancies, an automatic smoke detection system shall
2 be installed in corridors, waiting areas open to corridors and habitable spaces other than
3 sleeping units and kitchens. The system shall be activated in accordance with Section 907.4
4 ((907.5)).

5 **Exceptions:**

- 6 1. For Group I-1 Condition 1 occupancies, smoke detection in habitable spaces is not
7 required where the facility is equipped throughout with an automatic sprinkler system
8 installed in accordance with Section 903.3.1.1.
9 2. Smoke detection is not required for exterior balconies.

10 ***

11 [W] 907.2.6.4 Group I-4 occupancies. A manual fire alarm system that initiates the
12 occupant notification signal using an emergency voice/alarm communication system
13 meeting the requirements of Section 907.5.2.2 and installed in accordance with Section
14 907.6 shall be installed in Group I-4 occupancies. When automatic sprinkler systems or
15 smoke detectors are installed, such systems or detectors shall be connected to the building
16 fire alarm system.

17 **Exceptions:**

- 18 1. A manual fire alarm system is not required in Group I-4 occupancies with an
19 occupant load of 50 or less.
20 2. Emergency voice alarm communication systems meeting the requirements of
21 Section 907.5.2.2 and installed in accordance with Section 907.6 shall not be
22 required in Group I-4 occupancies with occupant loads of 100 or less, provided

1 that activation of the manual fire alarm system initiates an approved occupant
2 notification signal in accordance with Section 907.5.

3 **[F] 907.2.7 Group M.** A manual fire alarm system that activates the occupant notification
4 system in accordance with Section 907.5 shall be installed in Group M occupancies where one
5 of the following conditions exists:

- 6 1. The combined Group M occupant load of all floors is 500 or more persons.
- 7 2. The Group M occupant load is more than 100 persons above or below the lowest level of
8 exit discharge.

9 **Exceptions:**

- 10 1. A manual fire alarm system is not required in covered or open mall buildings
11 complying with Section 402.
- 12 2. Manual fire alarm boxes are not required where the building is equipped throughout
13 with an automatic sprinkler system installed in accordance with Section 903.3.1.1 and
14 the occupant notification appliances will automatically activate throughout the
15 notification zones upon sprinkler water flow.

16 ~~((**[F] 907.2.7.1 Occupant notification.** During times that the building is occupied, the~~
17 ~~initiation of a signal from a manual fire alarm box or from a waterflow switch shall not be~~
18 ~~required to activate the alarm notification appliances when an alarm signal is activated at a~~
19 ~~constantly attended location from which evacuation instructions shall be initiated over an~~
20 ~~emergency voice/alarm communication system installed in accordance with Section~~
21 ~~907.5.2.2.))~~

22 **[F] 907.2.8 Group R-1.** Fire alarm systems and smoke alarms shall be installed in Group R-1
23 occupancies as required in Sections 907.2.8.1 through 907.2.8.3.

1 **[F] 907.2.8.1 Manual fire alarm system.** A manual fire alarm system that activates the
2 occupant notification system in accordance with Section 907.5 shall be installed in Group R-
3 1 occupancies.

4 **Exceptions:**

5 1. A manual fire alarm system is not required in buildings not more than two stories in
6 height where all individual sleeping units and contiguous attic and crawl spaces to
7 those units are separated from each other and public or common areas by not less
8 than 1-hour fire partitions and each individual sleeping unit has an exit directly to a
9 public way, egress court or yard.

10 2. Manual fire alarm boxes are not required throughout the building where all of the
11 following conditions are met:

12 2.1. The building is equipped throughout with an automatic sprinkler system
13 installed in accordance with Section 903.3.1.1 or 903.3.1.2.

14 2.2. The notification appliances will activate upon sprinkler water flow.

15 2.3. Not fewer than one manual fire alarm box is installed at an approved location.

16 **[F] 907.2.8.2 Automatic ((smoke)) detection system.** An automatic smoke detection system
17 that activates the occupant notification system in accordance with Section 907.5 shall be
18 installed throughout all interior corridors serving sleeping units. Automatic heat detectors
19 shall be provided in any non-sprinklered interior areas outside guestrooms other than attics
20 and crawl spaces.

21 **Exception:** An automatic smoke detection system is not required in buildings that do not
22 have interior corridors serving sleeping units and where each sleeping unit has a means of

1 egress door opening directly to an exit or to an exterior exit access that leads directly to an
2 exit.

3 ***

4 **[F] 907.2.9 Group R-2.** Fire alarm systems and smoke alarms shall be installed in Group R-2
5 occupancies as required in Sections 907.2.9.1 through 907.2.9.3.

6 **[F] 907.2.9.1 Manual fire alarm system.** A manual fire alarm system that activates the
7 occupant notification system in accordance with Section 907.5 shall be installed in Group R-
8 2 occupancies where any of the following conditions apply:

- 9 1. Any dwelling unit or sleeping unit is located three or more stories above the lowest
10 level of exit discharge.
- 11 2. Any dwelling unit or sleeping unit is located more than one story below the highest
12 level of exit discharge of exits serving the dwelling unit or sleeping unit.
- 13 3. The building contains more than 16 dwelling units or sleeping units.

14 [W] 4. The building contains a boarding home licensed by the state of Washington.

15 **Exceptions:**

- 16 1. A fire alarm system is not required in buildings not more than two stories in height
17 where all dwelling units or sleeping units and contiguous attic and crawl spaces are
18 separated from each other and public or common areas by not less than 1-hour fire
19 partitions and each dwelling unit or sleeping unit has an exit directly to a public
20 way, egress court or yard.
- 21 2. Manual fire alarm boxes are not required where the building is equipped
22 throughout with an automatic sprinkler system installed in accordance with Section

1 903.3.1.1 or 903.3.1.2 and the occupant notification appliances will automatically
2 activate throughout the notification zones upon a sprinkler water flow.

3 3. A fire alarm system is not required in buildings that do not have interior corridors
4 serving dwelling units and are protected by an approved automatic sprinkler
5 system installed in accordance with Section 903.3.1.1 or 903.3.1.2, provided that
6 dwelling units either have a means of egress door opening directly to an exterior
7 exit access that leads directly to the exits or are served by open-ended corridors
8 designed in accordance with Section 1027.6, Exception 3.

9 4. A fire alarm system is not required in townhouses where approved by the fire code
10 official.

11 [W] 5. In boarding homes licensed by the state of Washington, manual fire alarm
12 boxes in resident sleeping areas are not required at exits if located at all constantly
13 attended staff locations if such staff locations are visible, continuously accessible,
14 located on each floor, and positioned so no portion of the story exceeds a
15 horizontal travel distance of 200 feet to a manual fire alarm box.

16 ***

17 **907.2.9.4 Automatic heat detection.** An automatic heat detection system that activates the
18 occupant notification system in accordance with Section 907.6 shall be installed throughout
19 all unsprinklered interior areas outside dwelling or sleeping units other than attics and crawl
20 spaces.

21 [W] (~~[F]~~) **907.2.10 Group R-4.** Fire alarm systems and smoke alarms shall be installed in
22 Group R-4 occupancies as required in Sections 907.2.10.1 through 907.2.10.3.

1 ~~[F] 907.2.10.1 Manual fire alarm system.~~ A manual fire alarm system that activates the
2 occupant notification system in accordance with Section 907.5 shall be installed in Group R-
3 4-occupancies.

4 **Exceptions:**

- 5 1. A manual fire alarm system is not required in buildings not more than two stories in
6 height where all individual sleeping units and contiguous attic and crawl spaces to
7 those units are separated from each other and public or common areas by not less than
8 1-hour fire partitions and each individual sleeping unit has an exit directly to a public
9 way, egress court or yard.
- 10 2. Manual fire alarm boxes are not required throughout the building where all of the
11 following conditions are met:
- 12 2.1. The building is equipped throughout with an *automatic sprinkler system* installed
13 in accordance with Section 903.3.1.1 or 903.3.1.2.
- 14 2.2. The notification appliances will activate upon sprinkler water flow.
- 15 2.3. Not fewer than one manual fire alarm box is installed at an approved location.
- 16 3. Manual fire alarm boxes in resident or patient sleeping areas shall not be required at
17 exits where located at all nurses' control stations or other constantly attended staff
18 locations, provided such stations are visible and continuously accessible and that the
19 distances of travel required in Section 907.4.2.1 are not exceeded.

20 ~~[F] 907.2.10.2 Automatic smoke detection system.~~ An automatic smoke detection system
21 that activates the occupant notification system in accordance with Section 907.5 shall be
22 installed in corridors, waiting areas open to corridors and habitable spaces other than sleeping
23 units and kitchens.

Exceptions:

~~1. Smoke detection in habitable spaces is not required where the facility is equipped throughout with an automatic sprinkler system installed in accordance with Section 903.3.1.1.~~

~~2. An automatic smoke detection system is not required in buildings that do not have interior corridors serving sleeping units and where each sleeping unit has a means of egress door opening directly to an exit or to an exterior exit access that leads directly to an exit.~~

~~[F] 907.2.10.3 Smoke alarms. Single and multiple station smoke alarms shall be installed in accordance with Section 907.2.11.))~~

[F] 907.2.11.2 Groups R-2, R-3(,R-4) and I-1. Single or multiple-station smoke alarms shall be installed and maintained in Groups R-2, R-3(,R-4) and I-1 regardless of occupant load at all of the following locations:

1. On the ceiling or wall outside of each separate sleeping area in the immediate vicinity of bedrooms.
2. In each room used for sleeping purposes.
3. In each story within a dwelling unit, including basements but not including crawl spaces and uninhabitable attics. In dwellings or dwelling units with split levels and without an intervening door between the adjacent levels, a smoke alarm installed on the upper level shall suffice for the adjacent lower level provided that the lower level is less than one full story below the upper level.

1 [F] 907.2.11.6 Power source. In new construction, required smoke alarms shall receive their
2 primary power from the building wiring where such wiring is served from a commercial
3 source and shall be equipped with a battery backup. Smoke alarms with integral strobes that
4 are not equipped with battery backup shall be connected to an emergency ~~((electrical))~~ power
5 system in accordance with Section 2702. Smoke alarms shall emit a signal when the batteries
6 are low. Wiring shall be permanent and without a disconnecting switch other than as required
7 for overcurrent protection.

8 **Exception:** Smoke alarms are not required to be equipped with battery backup where they
9 are connected to an emergency ~~((electrical))~~ power system that complies with Section
10 2702.

11 ***

12 [F] 907.2.13 High-rise buildings. High-rise buildings shall be provided with an automatic
13 smoke detection system in accordance with Section 907.2.13.1, a fire department
14 communication system in accordance with Section 907.2.13.2 and an emergency voice/alarm
15 communication system in accordance with Section 907.5.2.2.

16 **Exceptions:**

- 17 1. Airport traffic control towers in accordance with Sections 412 and 907.2.22.
18 2. Open parking garages in accordance with Section 406.5.
19 3. Buildings with an occupancy in Group A-5 in accordance with Section 303.1.
20 4. Low-hazard special occupancies in accordance with Section 503.1.1.

21 ~~((5. Buildings with an occupancy in Group H-1, H-2 or H-3 in accordance with Section
22 415.~~

1 **Exception((s):**

2 ~~((1. The supervisory signal at a constantly attended location is not required where duct~~
3 ~~smoke detectors activate the building's alarm notification appliances.~~

4 2.)) In occupancies not required to be equipped with a fire alarm system, actuation of
5 a smoke detector shall activate a visible and an audible signal in an approved location.
6 Smoke detector trouble conditions shall activate a visible or audible signal in an
7 approved location and shall be identified as air duct detector trouble.

8 **[F] 907.3.2 Delayed egress locks.** Where delayed egress locks are installed on means of egress
9 doors in accordance with Section 1010.1.9.7, an automatic smoke or heat detection system
10 shall be installed as required by that section.

11 **[F] 907.3.3 Elevator emergency operation.** Automatic fire detectors installed for elevator
12 emergency operation shall be installed in accordance with the provisions of ~~((ASME A17.1 and~~
13 ~~NFPA 72))~~ rules promulgated by the building or fire code official.

14 ***

15 **[F] 907.5.2 Alarm notification appliances.** Alarm notification appliances shall be provided
16 and shall be listed for their purpose.

17 **[F] 907.5.2.1 Audible alarms.** Audible alarm notification appliances shall be provided and
18 emit a distinctive sound that is not to be used for any purpose other than that of a fire alarm.

19 **Exceptions:**

- 20 1. Audible alarm notification appliances are not required in critical care areas of Group I-
- 21 2 Condition 2 occupancies that are in compliance with Section 907.2.6, Exception 2.
- 22 2. A visible alarm notification appliance installed in a nurses' control station or other
- 23 continuously attended staff location in a Group I-2 Condition 2 suite shall be an

1 acceptable alternative to the installation of audible alarm notification appliances
2 throughout the suite in Group I-2 Condition 2 occupancies that are in compliance with
3 Section 907.2.6, Exception 2.

- 4 3. Where provided, audible notification appliances located in each occupant evacuation
5 elevator lobby in accordance with Section 403.6.2.9 ((3008.9.1)) shall be connected to
6 a separate notification zone for manual paging only.

7 **[F] 907.5.2.1.1 Average sound pressure.** The audible alarm notification appliances shall
8 provide a sound pressure level of 15 decibels (dBA) above the average ambient sound level
9 or 5 dBA above the maximum sound level having duration of not less than 60 seconds,
10 whichever is greater, in every occupiable space within the building. The minimum sound
11 pressure levels shall be: 75 dBA in occupancies in Groups R and I-Condition 1; 90 dBA in
12 mechanical equipment rooms; and 60 dBA in other occupancies.

13 **Exceptions:**

- 14 1. Private mode signaling in accordance with NFPA 72 is allowed in areas of I-2 and I-
15 3 occupancies if occupants are not expected to self-evacuate.
16 2. Alarm systems installed in selected parts of a building are required to meet sound
17 pressure requirements within the selected area of the building only.

18 **[F] 907.5.2.1.2 Maximum sound pressure.** The maximum sound pressure level for
19 audible alarm notification appliances shall be 110 dBA at the minimum hearing distance
20 from the audible appliance. Where the average ambient noise is greater than 95 dBA,
21 visible alarm notification appliances shall be provided in accordance with NFPA 72 and
22 audible alarm notification appliances shall not be required.

1 **[F] 907.5.2.2 Emergency voice/alarm communication systems.** Emergency voice/alarm
2 communication systems required by this code shall be designed and installed in accordance
3 with NFPA 72. The operation of any automatic fire detector, sprinkler waterflow device or
4 manual fire alarm box shall automatically sound an alert tone followed by voice instructions
5 giving approved information and directions for a general or staged evacuation in accordance
6 with the building’s fire safety and evacuation plans required by Section 404 of the
7 *International Fire Code*. In high-rise buildings, the system shall operate on at least the
8 alarming floor, the floor above and ((the)) 2 floors below. Speakers shall be provided
9 throughout the building by paging zones. At a minimum, paging zones shall be provided as
10 follows:

- 11 1. Elevator groups.
- 12 2. *Interior exit* stairways.
- 13 3. Each floor.
- 14 4. *Areas of refuge* as defined in Chapter 2.

15 **Exception:** In Group I-1 and I-2 occupancies, the alarm shall sound in a constantly
16 attended area and a general occupant notification shall be broadcast over the overhead
17 page.

18 ***

19 **[F] 907.5.2.3 Visible alarms.** Visible alarm notification appliances shall be provided in
20 accordance with Sections 907.5.2.3.1 through 907.5.2.3.3 and rules promulgated by the
21 building official or fire code official.

1
2
3
4
5
6
7
8
9
10
11
12
13
14
15
16
17
18
19
20
21
22
23

Exceptions:

1. Visible alarm notification appliances are not required in alterations, except where an existing fire alarm system is upgraded or replaced, or a new fire alarm system is installed.
2. Visible alarm notification appliances shall not be required in exits as defined in Chapter 2.
3. Visible alarm notification appliances shall not be required in elevator cars.
4. Visual alarm notification appliances are not required in critical care areas of Group I-2 Condition 2 occupancies that are in compliance with Section 907.2.6, Exception 2.

[F] 907.6.1 Wiring. Wiring shall comply with the requirements of ~~((NFPA 70))~~ the Seattle Electrical Code and NFPA 72. Wireless protection systems utilizing radio-frequency transmitting devices shall comply with the special requirements for supervision of low-power wireless systems in NFPA 72.

[F] 907.6.4 Zones. Each floor shall be zoned separately and a zone shall not exceed 22,500 square feet (2090 m²). The length of any zone shall not exceed 300 feet (91440 mm) in any direction.

Exception: Automatic sprinkler system zones shall not exceed the area permitted by NFPA 13.

[F] 907.6.4.1 ~~((Zoning indicator panel. A zoning indicator panel and the associated controls shall be provided in an approved location.))~~ **Annunciator panel.** All fire alarm systems in buildings without a fire command center shall be provided with an annunciator panel (or the

1 main fire alarm control panel) located inside the building at the main building entrance. The
2 visual zone indication shall lock in until the system is reset and shall not be canceled by the
3 operation of an audible-alarm silencing switch.

4 ***

5 **[F] 907.6.6 Monitoring.** Fire alarm systems required by this chapter or by the *International*
6 *Fire Code* shall be monitored by an approved supervising station in accordance with NFPA 72.

7 **Exception:** Monitoring by a supervising station is not required for:

- 8 1. Single- and multiple-station smoke alarms required by Section 907.2.11.
- 9 2. Smoke detectors in Group I-3 occupancies.
- 10 3. Automatic sprinkler systems in one- and two- family dwellings and townhouses.

11 ***

12 **[F] 907.7 Acceptance tests and completion.** Upon completion of the installation, and after the
13 electrical inspector has approved the installation, the fire alarm system and all fire alarm
14 components shall be tested in accordance with NFPA 72.

15 ***

16 SECTION 909

17 SMOKE CONTROL SYSTEMS

18 ***

19 **[F] 909.11 Emergency ((~~Standby~~)) power.** Smoke control systems shall be provided with
20 ((~~standby~~)) emergency power in accordance with Section 2702.

21 **Exceptions:**

- 22 1. Stairway pressurization systems for non-high rise buildings shall be provided with
23 legally-required standby power in accordance with Section 909.20.5.6.

1 2. Hoistway pressurization systems for non-high rise buildings shall be provided with
2 legally-required standby power in accordance with Section 909.21.6.

3 **909.11.1 Equipment room.** The ((standby)) emergency power source and its transfer switches
4 shall be in a room separate from the normal power transformers and switch gears and
5 ventilated directly to and from the exterior. The room shall be enclosed with not less than 1-
6 hour fire barriers constructed in accordance with Section 707 or horizontal assemblies
7 constructed in accordance with Section 711, or both.

8 **Exceptions:**

9 1. Where located within a sprinklered parking garage of Type I or II construction,
10 emergency power and legally required standby power systems with fixed fuel quantities
11 meeting the limits of Section 603.3 of the International Fire Code, and their transfer
12 switches, are not required to be in a separate room. Other occupancies located in the
13 story where the system is located shall be separated from the system by fire barriers
14 with a minimum 1 hour fire-resistance rating.

15 2. Combustion and radiator intake air are permitted to be transferred from the adjacent
16 garage. Radiator discharge air is permitted to be transferred to the adjacent
17 garage. Radiator ventilation intake and discharge air locations shall be separated to
18 maintain the radiator ventilation intake air temperature below the maximum
19 temperature allowed to meet the emergency and legally required standby power system
20 loads.

21 **[F] 909.11.2 Power sources and power surges.** Elements of the smoke control system relying
22 on volatile memories or the like shall be supplied with uninterruptable power sources of
23 sufficient duration to span 15-minute primary power interruption. Elements of the smoke

1 control system susceptible to power surges shall be suitably protected by conditioners,
2 suppressors or other approved means.

3 **909.11.3 Wiring.** In addition to meeting requirements of the Seattle Electrical Code, all wiring
4 regardless of voltage, shall have fire-resistance-rated protection of at least two hours or as
5 required in rules promulgated by the building official.

6 **Exception:** Subject to the approval of the building official, fire-resistance rating is not
7 required for wiring located in a parking garage.

8 **[F] 909.12 Detection and control systems.** Fire detection systems providing control input or
9 output signals to mechanical smoke control systems or elements thereof shall comply with the
10 requirements of Section 907. Such systems shall be equipped with a control unit complying with
11 UL 864 and listed as smoke control equipment.

12 **909.12.1 Verification.** Control systems for mechanical smoke control systems shall include
13 provisions for verification. Verification shall include positive confirmation of actuation, testing,
14 manual override and the presence of power downstream of all disconnects. A preprogrammed
15 weekly test sequence shall report abnormal conditions audibly, visually and by printed report.
16 The preprogrammed weekly test shall operate all devices, equipment and components used for
17 smoke control.

18 **Exceptions:**

- 19 1. Where verification of individual components tested through the preprogrammed
20 weekly testing sequence will interfere with, and produce unwanted effects to, normal
21 building operation, such individual components are permitted to be bypassed from the
22 preprogrammed weekly testing, where approved by the building official and in
23 accordance with both of the following:

1 be located in a fire command center complying with Section 911 in high-rise buildings or
2 buildings with smoke-protected assembly seating. In all other buildings, the fire fighter's smoke
3 control panel shall be installed in an approved location adjacent to the fire alarm control panel.
4 The fire fighter's smoke control panel shall comply with Sections 909.16.1 through 909.16.3.
5 The smoke control panel for high rise buildings shall include a visual depiction of the building
6 showing typical floor plan(s) with locations of interior exit stairways and elevator hoistways.
7 The panel shall also include section views of the building to show the extent of travel for each
8 interior exit stairway and elevator. Interior exit stairways and elevator hoistways shall be labeled
9 on the plan section views to match the labeling used in the building itself.

10 **Exception:** For buildings that use only stairway and elevator hoistway pressurization for
11 smoke control, pressurization fan status and controls in accordance with Section 909.16.2 (or
12 equivalent) may be installed on the main fire alarm control panel (FACP) in lieu of installing a
13 dedicated fire-fighter's smoke control panel. The building graphics normally provided on the
14 smoke control panel shall be laminated and mounted in the vicinity of the FACP for quick
15 reference by emergency responders.

16 **Note:** This exception may be applied to ventilation systems other than interior exit stairway
17 supply air systems to exhaust air from adjacent space.

18 **[F] 909.16.1 Smoke control systems.** Fans within the building shall be shown on the fire
19 fighter's control panel. Fan control switches shall be located on the panel in the vicinity of the
20 location where the shaft supplied by each fan is depicted. A clear indication of the direction of
21 airflow and the relationship of components shall be displayed. Status indicators shall be
22 provided for all fans ((smoke control equipment, annunciated by fan and zone, and by pilot-
23 lamp type indicators)) as follows:

- 1 1. Fans in a ready/non-operating status—WHITE. (~~(, dampers and other operating~~
2 ~~equipment in their normal status—WHITE.)~~)
- 3 2. Fans in their off status—RED. (~~(, dampers and other operating equipment in their off or~~
4 ~~closed status—RED.)~~)
- 5 3. Fans in operation—GREEN (~~(, dampers and other operating equipment in their on or~~
6 ~~open status—GREEN)~~).
- 7 4. Fans in a fault condition—YELLOW/AMBER. (~~(, dampers and other operating~~
8 ~~equipment in a fault status—YELLOW/AMBER.)~~)

9 **[F] 909.16.2 Smoke control panel.** The fire fighter's control panel shall provide control
10 capability over the complete smoke control system equipment within the building as follows:

- 11 1. ON-AUTO-OFF control over each shaft pressurization fan. (~~(individual piece of~~
12 ~~operating smoke control equipment that can also be controlled from other sources within~~
13 ~~the building. This includes *stairway* pressurization fans; smoke exhaust fans; supply,~~
14 ~~return and exhaust fans; elevator shaft fans and other operating equipment used or~~
15 ~~intended for smoke control purposes.)~~)
- 16 2. AUTO-OFF-POSITIVE PRESSURE-NEGATIVE PRESSURE control over each smoke
17 control zone designed with such features. Individual control of each damper and fan used
18 to achieve the positive or negative pressure condition is not required. (~~(OPEN-AUTO-~~
19 ~~CLOSE control over individual *dampers* relating to smoke control and that are also~~
20 ~~controlled from other sources within the building.)~~)
- 21 3. AUTO-EXHAUST-OFF control over each smoke control zone using the exhaust method
22 of smoke control. (~~(ON-OFF or OPEN-CLOSE control over smoke control and other~~

1 ~~critical equipment associated with a fire or smoke emergency and that can only be~~
2 ~~controlled from the fire fighter's control panel.))~~

3 **Exceptions:**

- 4 1. Complex systems, where approved, where the controls and indicators are combined to
5 control and indicate all elements of a single smoke zone as a unit.
6 2. Complex systems, where approved, where the control is accomplished by computer
7 interface using approved, plain English commands.

8 **[F] 909.16.3 Control action and priorities.** The firefighter's control panel actions shall be as
9 follows:

- 10 1. ON-OFF and OPEN-CLOSE control actions shall have the highest priority of any
11 control point within the building. Once issued from the fire fighter's control panel,
12 automatic or manual control from any other control point within the building shall not
13 contradict the control action. Where automatic means are provided to interrupt normal,
14 nonemergency equipment operation or produce a specific result to safeguard the
15 building or equipment including, but not limited to, duct freezestats, duct smoke
16 detectors, high-temperature cutouts, temperature-actuated linkage and similar devices,
17 such means shall be capable of being overridden by the fire fighter's control panel. The
18 last control action as indicated by each fire fighter's control panel switch position shall
19 prevail. Control actions shall not require the smoke control system to assume more than
20 one configuration at any one time.

21 **Exception:** Power disconnects required by ~~((NFPA-70))~~ the Seattle Electrical
22 Code.

1 2. Only the AUTO position of each three-position fire fighter's control panel switch shall
2 allow automatic or manual control action from other control points within the building.
3 The AUTO position shall be the NORMAL, nonemergency, building control position.
4 Where a fire fighter's control panel is in the AUTO position, the actual status of the
5 device (on, off, open, closed) shall continue to be indicated by the status indicator
6 described in Section 909.16.1. Where directed by an automatic signal to assume an
7 emergency condition, the NORMAL position shall become the emergency condition for
8 that device or group of devices within the zone. Control actions shall not require the
9 smoke control system to assume more than one configuration at any one time.

10 ***

11 **[F] 909.18.8 Testing for smoke control.** Smoke control systems shall be tested by a special
12 inspector for compliance with the approved design in accordance with Section 1705.18.

13 **[F] 909.18.8.1 Scope of testing.** Testing shall be conducted ~~((in accordance with the~~
14 ~~following:))~~ prior to occupancy and after sufficient completion for the purposes of pressure-
15 difference testing, flow measurements, and detection and control verification.

16 ~~((1. During erection of ductwork and prior to concealment for the purposes of leakage~~
17 ~~testing and recording of device location.~~

18 ~~2. Prior to occupancy and after sufficient completion for the purposes of pressure-~~
19 ~~difference testing, flow measurements, and detection and control verification.))~~

20 ***

21 **[F] 909.18.8.3 Reports.** A complete report of testing shall be prepared by the approved
22 agency. The report shall include identification of all devices by manufacturer, nameplate data,
23 design values, measured values and identification tag or mark. The report shall be reviewed

1 by the responsible registered design professional and, when satisfied that the design intent
2 has been achieved, the responsible registered design professional shall sign, seal and date the
3 report.

4 **[F] 909.18.8.3.1 Report filing.** A copy of the final report (~~(shall be filed with the fire code~~
5 ~~official and an identical copy))~~ shall be maintained in an approved location at the building
6 and shall be made available to the fire department on request.

7 ***

8 **[F] 909.19 System acceptance.** Buildings, or portions thereof, required by this code to comply
9 with this section shall not be issued a certificate of occupancy until such time that the fire code
10 official determines that the provisions of this section have been fully complied with and that the
11 fire department has received satisfactory instruction on the operation, both automatic and
12 manual, of the system and a written maintenance program complying with the requirements of
13 Section 909.20~~((1))~~ of the International Fire Code has been submitted and approved by the fire
14 code official.

15 **Exception:** In buildings of phased construction, a temporary certificate of occupancy, as
16 approved by the ~~((fire code))~~ building official, shall be allowed provided that those portions of
17 the building to be occupied meet the requirements of this section and that the remainder does
18 not pose a significant hazard to the safety of the proposed occupants or adjacent buildings.

19 ~~**(909.20 Smokeproof enclosures.** Where required by Section 1023.11, a smokeproof enclosure~~
20 ~~shall be constructed in accordance with this section. A smokeproof enclosure shall consist of an~~
21 ~~interior exit stairway or ramp that is enclosed in accordance with the applicable provisions of~~
22 ~~Section 1023 and an open exterior balcony or ventilated vestibule meeting the requirements of~~

1 ~~this section. Where access to the roof is required by the *International Fire Code*, such access~~
2 ~~shall be from the smokeproof enclosure where a smokeproof enclosure is required.~~

3 **909.20.1 Access.** ~~Access to the stairway or ramp shall be by way of a vestibule or an open~~
4 ~~exterior balcony. The minimum dimension of the vestibule shall be not less than the required~~
5 ~~width of the corridor leading to the vestibule but shall not have a width of less than 44 inches~~
6 ~~(1118 mm) and shall not have a length of less than 72 inches (1829 mm) in the direction of~~
7 ~~egress travel.~~

8 **909.20.2 Construction.** ~~The smokeproof enclosure shall be separated from the remainder of~~
9 ~~the building by not less than 2-hour fire barriers constructed in accordance with Section 707 or~~
10 ~~horizontal assemblies constructed in accordance with Section 711, or both. Openings are not~~
11 ~~permitted other than the required means of egress doors. The vestibule shall be separated from~~
12 ~~the stairway or ramp by not less than 2-hour fire barriers constructed in accordance with~~
13 ~~Section 707 or horizontal assemblies constructed in accordance with Section 711, or both. The~~
14 ~~open exterior balcony shall be constructed in accordance with the fire resistance rating~~
15 ~~requirements for floor assemblies.~~

16 **909.20.2.1 Door closers.** ~~Doors in a smokeproof enclosure shall be self- or automatic-closing~~
17 ~~by actuation of a smoke detector in accordance with Section 716.5.9.3 and shall be installed~~
18 ~~at the floor-side entrance to the smokeproof enclosure. The actuation of the smoke detector~~
19 ~~on any door shall activate the closing devices on all doors in the smokeproof enclosure at all~~
20 ~~levels. Smoke detectors shall be installed in accordance with Section 907.3.~~

21 **909.20.3 Natural ventilation alternative.** ~~The provisions of Sections 909.20.3.1 through~~
22 ~~909.20.3.3 shall apply to ventilation of smokeproof enclosures by natural means.~~

1 ~~909.20.3.1 Balcony doors.~~ Where access to the stairway or ramp is by way of an open
2 exterior balcony, the door assembly into the enclosure shall be a fire door assembly in
3 accordance with Section 716.5.

4 ~~909.20.3.2 Vestibule doors.~~ Where access to the stairway or ramp is by way of a vestibule,
5 the door assembly into the vestibule shall be a fire door assembly complying with Section
6 716.5. The door assembly from the vestibule to the stairway shall have not less than a 20-
7 minute fire protection rating complying with Section 716.5.

8 ~~909.20.3.3 Vestibule ventilation.~~ Each vestibule shall have a minimum net area of 16 square
9 feet (1.5 m²) of opening in a wall facing an outer court, yard or public way that is not less
10 than 20 feet (6096 mm) in width.

11 ~~909.20.4 Mechanical ventilation alternative.~~ The provisions of Sections 909.20.4.1 through
12 909.20.4.4 shall apply to ventilation of smokeproof enclosures by mechanical means.

13 ~~909.20.4.1 Vestibule doors.~~ The door assembly from the building into the vestibule shall be
14 a fire door assembly complying with Section 716.5.3. The door assembly from the vestibule
15 to the stairway or ramp shall not have less than a 20-minute fire protection rating and shall
16 meet the requirements for a smoke door assembly in accordance with Section 716.5.3. The
17 door shall be installed in accordance with NFPA 105.

18 ~~909.20.4.2 Vestibule ventilation.~~ The vestibule shall be supplied with not less than one air
19 change per minute and the exhaust shall be not less than 150 percent of supply. Supply air
20 shall enter and exhaust air shall discharge from the vestibule through separate, tightly
21 constructed ducts used only for that purpose. Supply air shall enter the vestibule within 6
22 inches (152 mm) of the floor level. The top of the exhaust register shall be located at the top
23 of the smoke trap but not more than 6 inches (152 mm) down from the top of the trap, and

1 shall be entirely within the smoke trap area. Doors in the open position shall not obstruct duct
2 openings. Duct openings with controlling dampers are permitted where necessary to meet the
3 design requirements, but dampers are not otherwise required.

4 ~~**909.20.4.2.1 Engineered ventilation system.** Where a specially engineered system is used,~~
5 ~~the system shall exhaust a quantity of air equal to not less than 90 air changes per hour~~
6 ~~from any vestibule in the emergency operation mode and shall be sized to handle three~~
7 ~~vestibules simultaneously. Smoke detectors shall be located at the floor-side entrance to~~
8 ~~each vestibule and shall activate the system for the affected vestibule. Smoke detectors~~
9 ~~shall be installed in accordance with Section 907.3.~~

10 ~~**909.20.4.3 Smoke trap.** The vestibule ceiling shall be not less than 20 inches (508 mm)~~
11 ~~higher than the door opening into the vestibule to serve as a smoke and heat trap and to~~
12 ~~provide an upward moving air column. The height shall not be decreased unless approved~~
13 ~~and justified by design and test.~~

14 ~~**909.20.4.4 Stairway or ramp shaft air movement system.** The stairway or ramp shaft shall~~
15 ~~be provided with a dampered relief opening and supplied with sufficient air to maintain a~~
16 ~~minimum positive pressure of 0.10 inch of water (25 Pa) in the shaft relative to the vestibule~~
17 ~~with all doors closed.))~~

18 **909.20.5 Stairway and ramp pressurization for high-rise buildings ((alternative)).** Where
19 required by Section 403.5.4 or 405.7.2, ~~((the building is equipped throughout with an~~
20 ~~automatic sprinkler system in accordance with Section 903.3.1.1, the vestibule is not required,~~
21 ~~provided)) each interior exit stairway or ramp ((is)) shall be pressurized to not less than 0.10
22 inch of water (25 Pa) and not more than 0.35 inches of water (87 Pa) in the shaft relative to the
23 building measured with all interior exit stairway and ramp doors closed under maximum~~

1 anticipated conditions of stack effect and wind effect. The pressure differential shall be
2 measured between the interior exit stairway and the adjacent area. In residential buildings, the
3 pressure differential is permitted to be measured between the interior exit stairway and the
4 dwelling units.

5 **Exception:** The pressure differential is permitted to be measured relative to outdoor
6 atmosphere on floors other than the following:

- 7 1. The fire floor,
- 8 2. The two floors immediately below the fire floor, and
- 9 3. The floor immediately above the fire floor.

10 **909.20.5.1 Supply air.** Air for stairway pressurization shall be supplied at intervals sufficient
11 to maintain the required pressure throughout the interior exit stairway.

12 **Note:** The performance goal for Section 909.20.5.1 is compliance with minimum and
13 maximum pressures at all levels of the shaft.

14 **909.20.5.2 Supply air.** Supply air shall be taken directly from an outside, uncontaminated
15 source at least 20 feet (6096 mm) from any air outlet. The supply air intake shall be located at
16 the exterior of the building. The intake shall be continuous to the exterior of the building. The
17 fan system shall be equipped with two smoke detectors located in the duct in accordance with
18 NFPA 72 arranged to automatically shut down the fan system only when both smoke
19 detectors activate. The detectors shall be located downstream of the fan and shall be
20 connected to the fire alarm as a supervisory signal.

21 **909.20.5.3 Dampered relief opening.** The interior exit stairway shall be equipped with a
22 relief opening at the top. The relief opening shall be equipped with a barometric relief
23 damper and a motorized damper that complies with the *International Energy Conservation*

1 Code. The motorized damper shall be of the normally open type (open with the power off).

2 Activation of the damper shall be initiated by the building fire alarm system and by actuation
3 of the automatic sprinkler system.

4 The pressurization system shall be capable of maintaining the differential pressure required
5 by Section 909.20.5 while discharging 2,500 cubic feet per minute (1180 L/s) of air through
6 the relief opening.

7 The relief outlet shall be located at least 20 feet from elevator hoistway and stairway
8 pressurization system supply air intake locations.

9 **909.20.5.4 ((909.20.6 Ventilating)) Activation of pressurization equipment.** The
10 ~~((activation of ventilating))~~ pressurization equipment required by ((the alternatives in))
11 ~~Section((s 909.20.4 and))~~ 909.20.5 shall be activated by a fire alarm signal originating
12 anywhere in the building. ((smoke detectors installed at each floor level at an approved
13 location at the entrance to the smokeproof enclosure. When the closing device for the
14 stairway and ramp shaft and vestibule doors is activated by smoke detection or power failure,
15 ~~the mechanical equipment shall activate and operate at the required performance levels.))~~
16 Smoke detectors shall be installed in accordance with Section 907.3.

17 **909.20.5.5 Independence of pressurization systems. ((909.20.6.1 Ventilation systems.))**
18 ~~((Smokeproof enclosure ventilation))~~ Stairway pressurization systems shall be independent
19 of other building ventilation systems.

20 **Exception:** Ventilation systems other than interior exit stairway supply air systems are
21 permitted to be used to exhaust air from adjacent space when necessary to maintain the
22 differential pressure relationships. Ventilation systems used to achieve stairway
23 pressurization are not required to comply with Sections 909.20.5.6 and 909.20.5.7.

1 **909.20.5.6 Protection of equipment.** The equipment, control wiring, power wiring and
2 ductwork shall comply with one of the following:

3 1. Equipment, control wiring, power wiring and ductwork shall be located exterior to the
4 building and directly connected to the ~~((smokeproof enclosure))~~ interior exit stairway
5 or connected to the ~~((smokeproof enclosure))~~ interior exit stairway by ductwork
6 enclosed by ~~((not less than 2-hour))~~ *fire barriers* constructed in accordance with
7 Section 707 or *horizontal assemblies* constructed in accordance with Section 711, or
8 both.

9 2. Equipment, control wiring, power wiring and ductwork shall be located within the
10 ~~((smokeproof enclosure))~~ interior exit stairway with intake or exhaust directly from
11 and to the outside or through ductwork enclosed by not less than 2-hour fire barriers
12 constructed in accordance with Section 707 or horizontal assemblies constructed in
13 accordance with Section 711, or both.

14 3. Equipment, control wiring, power wiring and ductwork shall be located within the
15 building if separated from the remainder of the building, including other mechanical
16 equipment, by not less than 2-hour *fire barriers* constructed in accordance with
17 Section 707 or *horizontal assemblies* constructed in accordance with Section 711, or
18 both.

19 **Exceptions:**

- 20 1. Control wiring and power wiring utilizing a 2-hour rated cable.
21 2. Where encased with not less than 2 inches (51 mm) of concrete.
22 3. Control wiring and power wiring protected by a listed electrical circuit protective
23 system with a fire-resistance rating of not less than 2 hours.

1 4. Ventilation systems other than interior exit stairway supply air systems are permitted
2 to be used to exhaust air from adjacent space when necessary to maintain the
3 differential pressure relationships. Ventilation systems used to achieve stairway
4 pressurization are not required to comply with Sections 909.

5 **Interpretation I909.20:** Dampers other than motorized dampers required by the
6 *International Energy Conservation Code* are not permitted in stairway pressurization system
7 air supply unless approved by the building official.

8 **909.20.5.7 ((909.20.6.2 Standby)) Emergency power system.** ((Mechanical vestibule and
9 *stairway and ramp shaft ventilation*)) Pressurization systems and automatic fire detection
10 systems shall be provided with ((standby)) emergency power in accordance with Section
11 2702.

12 **909.20.5.8 Smoke control provisions.** Stairway pressurization systems in high-rise
13 buildings shall comply with Sections 909.10 through 909.19 in addition to Section 909.20.5.
14 ~~((909.20.6.3 Acceptance and testing. Before the mechanical equipment is approved, the~~
15 ~~system shall be tested in the presence of the *building official* to confirm that the system is~~
16 ~~operating in compliance with these requirements.))~~

17 **909.20.6 Stairway pressurization for low-rise buildings.** Where stairway pressurization is
18 provided in accordance with Section 1006.3.2 exception 7 or Section 510.2 item 10 or 11, the
19 pressurization system shall comply with the following:

- 20 1. Stairways shall be pressurized to a minimum positive pressure of 0.15 inch of water
21 column (37 Pa) relative to the main occupied area on each floor, and a maximum
22 pressure that complies with Section 1010.1.3.

- 1 2. The stairway pressurization shall be activated by a fire alarm originating anywhere in
2 the building.
- 3 3. Pressurization equipment and its duct work located within the building shall be
4 separated from other portions of the building by construction equal to that required for
5 the interior exit stairway.
- 6 4. Supply air shall be taken directly from an outside, uncontaminated source at least 20
7 feet (6096 mm) from any air exhaust system or outlet. Air ducts shall be continuous to
8 the exterior of the building. Two smoke detectors shall be located in the duct in
9 accordance with NFPA 72 arranged to automatically shut down the fan system only
10 when both smoke detectors activate. The detectors shall be located downstream of the
11 fan and shall be connected to the fire alarm as a supervisory signal.
- 12 5. A legally required standby power system shall be provided for the pressurization
13 system according to *Seattle Electrical Code* Section 701. A connection ahead of the
14 service disconnecting means shall be permitted as the sole source of power to the
15 pressurization system.
- 16 6. Other measures to prevent loss of pressurization shall be provided in the design and
17 construction of interior exit stairways, such as doors and door closers, quality of
18 workmanship and caulking of penetrations and joints.
- 19 7. Stairway pressurization systems in low-rise buildings shall comply with Sections
20 909.10 through 909.19 in addition to Section 909.20.5.
- 21 **Exception:** A rational analysis complying with Section 909.4 is not required.

1 **909.21 Elevator hoistway pressurization alternative.** Where elevator hoistway pressurization
2 is provided in lieu of required enclosed elevator lobbies, the pressurization system shall comply
3 with Sections 909.21.1 through 909.21.8 (~~909.21.11~~).

4 **909.21.1 Pressurization requirements.** Elevator hoistways shall be pressurized to maintain a
5 minimum positive pressure of 0.10 inch of water (25 Pa) and a maximum positive pressure of
6 0.25 inch of water (67 Pa) with respect to adjacent occupied space on all floors. This pressure
7 shall be measured at the midpoint of each hoistway door, with all elevator cars at the floor of
8 recall and all hoistway doors on the floor of recall open and all other hoistway doors closed.
9 The pressure differentials shall be measured between the hoistway and the adjacent elevator
10 landing. The opening and closing of hoistway doors at each level must be demonstrated during
11 this test. (~~The supply air intake shall be from an outside, uncontaminated source located a~~
12 ~~minimum distance of 20 feet (6096 mm) from any air exhaust system or outlet.~~)

13 **Exceptions:**

- 14 1. On floors containing only Group R occupancies, the pressure differential is permitted to
15 be measured between the hoistway and a dwelling unit or sleeping unit.
- 16 2. Where an elevator opens into a lobby enclosed in accordance with Section (~~3007.6 or~~
17 ~~3008.6~~) 403.6.1.5 or 403.6.2.6, the pressure differential is permitted to be measured
18 between the hoistway and the space immediately outside the door(s) from the floor to
19 the enclosed lobby.
- 20 3. The pressure differential is permitted to be measured relative to the outdoor atmosphere
21 on floors other than the following:
 - 22 3.1. The fire floor.
 - 23 3.2. The two floors immediately below the fire floor.

1 3.3. The floor immediately above the fire floor.

2 4. The minimum positive pressure of 0.10 inch of water (25 Pa) and a maximum positive
3 pressure of 0.25 inch of water (67 Pa) with respect to occupied floors are not required at
4 the floor of recall with the doors open.

5 5. Subject to the approval of the building official, pressurization is not required for
6 elevators in high rise buildings with less than 75 feet (22 860 mm) from the lowest
7 floor to the highest ceiling of the stories served by the elevator.

8 **909.21.1.1 Supply air.** The supply air shall be taken from an outside, uncontaminated source
9 located a minimum distance of 20 feet (6096 mm) from any air outlet. The supply air intake
10 may be located within the building provided it is located no more than 20 feet (6096 mm)
11 from major openings in the building exterior such as loading docks and vehicular entrances.
12 There shall be no obstruction to the flow of air to the intake.

13 **909.21.1.2((1)) Use of ventilation systems.** Ventilation systems, other than hoistway supply
14 air systems, are permitted to be used to exhaust air from adjacent spaces on the fire floor, two
15 floors immediately below and one floor immediately above the fire floor to the building's
16 exterior where necessary to maintain positive pressure relationships as required in Section
17 909.21.1 during operation of the elevator shaft pressurization system. Ventilation systems
18 used to achieve hoistway pressurization are not required to comply with Section 909.21.4 and
19 909.21.5.

20 **909.21.2 ((Rational analysis.** ~~A rational analysis complying with Section 909.4 shall be~~
21 ~~submitted with the construction documents.))~~ No requirements.

22 **909.21.3 Ducts for system.** Any duct system that is part of the pressurization system shall be
23 protected with the same fire-resistance rating as required for the elevator shaft enclosure.

1 **Interpretation I909.21:** Dampers other than motorized dampers required by the *International*
2 *Energy Conservation Code* are not permitted in hoistway pressurization system supply air
3 system unless approved by the building official.

4 **909.21.4 Fan system.** The fan system provided for the pressurization system shall be as
5 required by Sections 909.21.4.1 through 909.21.4.4.

6 **909.21.4.1 Fire resistance.** Where located within the building, the fan system that provides
7 the pressurization shall be protected with the same fire-resistance rating required for the
8 elevator (~~shaft~~) hoistway enclosure.

9 **909.21.4.2 Smoke detection.** The fan system shall be equipped with ~~((a))~~ two smoke
10 detectors ~~((that will))~~ located in the duct in accordance with NFPA 72 arranged to
11 automatically shut down the fan system only when both smoke detectors activate. ~~((is~~
12 ~~detected within the system.))~~ The detectors shall be located downstream of the fan and shall
13 be connected to the fire alarm as a supervisory signal.

14 **909.21.4.3 Separate systems.** A separate fan system shall be used for each elevator hoistway.

15 **909.21.4.4 Fan capacity.** The ~~((supply))~~ fan system shall be provided with the capacity to
16 pressurize the elevator hoistway as determined by a registered design professional. The fan
17 system shall be provided with a means to balance or modulate the airflow to the elevator
18 hoistway to meet the differential pressure requirements on all floors for each condition
19 identified by the rational analysis. ~~((either adjustable with a capacity of not less than 1,000~~
20 ~~efm (0.4719 m³/s) per door, or that specified by a registered design professional to meet the~~
21 ~~requirements of a designed pressurization system.))~~

22 **909.21.5 Legally required ~~((S))~~standby and emergency power.** ~~((The))~~ Pressurization
23 systems shall be powered by an approved emergency or legally required standby power system.

1 An emergency power system conforming to Section 909.11 shall be provided for pressurization
2 systems in high-rise buildings. Legally required standby power shall be provided ((with)) for
3 the pressurization system in all other buildings. The emergency and legally required standby
4 power shall be in accordance with Section 2702. For other than high-rise buildings, connection
5 ahead of the service disconnecting means in accordance with Seattle Electrical Code Section
6 701.12(E) is permitted as a source of legally required standby power.

7 **909.21.6 Activation of pressurization system.** The elevator pressurization system shall be
8 activated upon activation of either the building fire alarm system or the elevator lobby smoke
9 detectors. Where both a building fire alarm system and elevator lobby smoke detectors are
10 present, each shall be independently capable of activating the pressurization system. Activation
11 of the fan serving the hoistway is permitted to be delayed by up to 30 seconds so that elevator
12 recall can be initiated prior to pressurizing the hoistway.

13 **909.21.7 Machine rooms.** Elevator machine rooms shall be pressurized in accordance with
14 this section unless separated from the elevator hoistway by construction in accordance with
15 Section 713. ((Testing. Testing for performance shall be required in accordance with Section
16 909.18.8. System acceptance shall be in accordance with Section 909.19.))

17 **909.21.8 Smoke control provisions.** Hoistway pressurization systems shall comply with
18 Sections 909.10 through 909.19 in addition to Section 909.21. ((Marking and identification.
19 Detection and control systems shall be marked in accordance with Section 909.14.

20 ~~**909.21.9 Control diagrams.** Control diagrams shall be provided in accordance with Section~~
21 ~~909.15.~~

22 ~~**909.21.10 Control panel.** A control panel complying with Section 909.16 shall be provided.~~

1 ~~909.21.11 System response time.~~ Hoistway pressurization systems shall comply with the
2 requirements for smoke control system response time in Section 909.17.))

3 ***

4 SECTION 910

5 SMOKE AND HEAT REMOVAL

6 ***

7 [F] 910.4.6 Control wiring. Wiring for operation and control of mechanical smoke removal
8 systems shall be connected ahead of the main disconnect in accordance with Section 701.12E of
9 ((NFPA 70)) the Seattle Electrical Code and be protected against interior fire exposure to
10 temperatures in excess of 1,000°F (538°C) for a period of not less than 15 minutes.

11 ***

12 SECTION 911

13 FIRE COMMAND CENTER

14 ***

15 [F] 911.1.1 Location and access. The location and accessibility of the fire command center
16 shall be approved by the fire ((chief)) code official.

17 [F] 911.1.2 Separation. The fire command center shall be separated from the remainder of the
18 building by not less than a ((1)) 2-hour fire barrier constructed in accordance with Section 707
19 or horizontal assembly constructed in accordance with Section 711, or both.

20 ***

21 [F] 911.1.6 Required features. The fire command center shall comply with NFPA 72 and shall
22 contain all of the following features:

- 23 1. The emergency voice/alarm communication system control unit.

- 1 2. The fire department communications system.
- 2 3. Fire detection and alarm system annunciator.
- 3 4. Annunciator unit visually indicating the location of the elevators and whether they are
- 4 operational.
- 5 5. Status indicators and controls for air distribution systems.
- 6 6. The fire fighter's control panel required by Section 909.16 for smoke control systems
- 7 installed in the building.
- 8 7. Controls for unlocking *interior exit stairway* doors simultaneously.
- 9 8. Sprinkler valve and waterflow detector display panels.
- 10 9. Emergency and legally required standby power status indicators.
- 11 10. A telephone for fire department use with controlled access to the public telephone
- 12 system.
- 13 11. Fire pump status indicators.
- 14 12. Schematic building plans indicating the typical floor plan and detailing the building
- 15 core, means of egress, fire protection systems, fire fighter air replenishment system,
- 16 fire-fighting equipment and fire department access and the location of fire walls, fire
- 17 barriers, fire partitions, smoke barriers and smoke partitions.
- 18 13. An approved Building Information Card that contains, but is not limited to, the
- 19 following information:
- 20 13.1. General building information that includes: property name, address, the number
- 21 of floors in the building above and below grade, use and occupancy classification
- 22 (for mixed uses, identify the different types of occupancies on each floor), and
- 23 the estimated building population during the day, night and weekend.

1 13.2. Building emergency contact information that includes: a list of the building's
2 emergency contacts including but not limited to building manager and building
3 engineer and their respective work phone number, cell phone number, e-mail
4 address.

5 13.3. Building construction information that includes: the type of building construction
6 including but not limited to floors, walls, columns, and roof assembly.

7 13.4. Exit access and exit stairway information that includes: number of exit access
8 and exit stairways in the building, each exit access and exit stairway designation
9 and floors served, location where each exit access and exit stairway discharges,
10 interior exit stairways that are pressurized, exit stairways provided with
11 emergency lighting, each exit stairway that allows reentry, exit stairways
12 providing roof access; elevator information that includes: number of elevator
13 banks, elevator bank designation, elevator car numbers and respective floors that
14 they serve; location of elevator machine rooms, control rooms and control
15 spaces; location of sky lobby, location of freight elevator banks.

16 13.5. Building services and system information that includes: location of mechanical
17 rooms, location of building management system, location and capacity of all fuel
18 oil tanks, location of emergency generator, location of natural gas service.

19 13.6. Fire protection system information that includes: location of standpipes, location
20 of fire pump room, location of fire department connections, floors protected by
21 automatic sprinklers, location of different types of automatic sprinkler systems
22 installed including, but not limited to, dry, wet and pre-action.

1 13.7 Hazardous material information that includes: location of hazardous material,
2 quantity of hazardous material.

3 14. Work table.

4 15. Generator supervision devices, manual start and stop (~~(transfer)~~) features.

5 16. Public address system, where specifically required by other sections of this code.

6 17. Elevator fire recall switch in accordance with ASME A17.1.

7 18. Elevator emergency or legally required standby power selector switch(es), where
8 emergency or standby power is provided.

9 19. On-site fire protection water tank fill-valve control switch, tank level indicators, tank
10 low-level alarm and tank fill signal.

11 SECTION 912

12 FIRE DEPARTMENT CONNECTIONS

13 ***

14 **[F] 912.5 Signs.** A metal sign with raised letters not less than 1 inch (25 mm) in size shall be
15 mounted on all fire department connections serving automatic sprinklers, standpipes or fire
16 pump connections. Such signs shall read: AUTOMATIC SPRINKLERS or STANDPIPES or
17 TEST CONNECTION or a combination thereof as applicable. Where the fire department
18 connection does not serve the entire building, a sign shall be provided indicating the portions
19 of the building served.

20 **912.5.1 Signs for high-rise buildings.** An additional sign with letters at least 1 inch in size
21 shall be provided at the fire department connections of high-rise buildings that indicate the
22 building fire pump static (churn) discharge pressure. Where the pump is more than two

1 stories above or below the fire department connections, the pump static/churn discharge
2 pressure on the signage shall be adjusted to correct for the elevation difference.

3 **[P] 912.6 Backflow protection.** The potable water supply to automatic sprinkler and standpipe
4 systems shall be protected against backflow as required by the (~~International~~) Uniform
5 Plumbing Code.

6 ***

7 SECTION 915

8 CARBON MONOXIDE DETECTION

9 **[F] 915.1 General.** Carbon monoxide detection shall be installed in new buildings in accordance
10 with Sections 915.1.1 through 915.6. Carbon monoxide detection shall be installed in existing
11 buildings in accordance with Chapter 11 of the *International Fire Code.*

12 **[W] [F] 915.1.1 Where required.** Carbon monoxide detection shall be provided in Group I(~~-~~
13 ~~1, I-2, I-4~~) and R occupancies and in classrooms in Group E occupancies in the locations
14 specified in Section 915.2 where any of the conditions in Sections 915.1.2 through 915.1.6
15 exist.

16 **Exceptions:**

- 17 1. Carbon monoxide detectors shall be installed in Group R-2 occupancies, with the
18 exception of Group R-2 college dormitories without exception.
- 19 2. Sleeping units or dwelling units in Group I and R occupancies and Group R-2
20 college dormitories, hotel, Department of Corrections prisons and work releases,
21 and boarding home and residential treatment facilities licensed by the State of
22 Washington, which do not contain a fuel-burning appliance, a fuel-burning

1 fireplace, or have an attached garage, need not be provided with carbon monoxide
2 alarms provided that they comply with the exceptions of Section 915.1.4.

3 **[F] 915.1.2 Fuel-burning appliances and fuel-burning fireplaces.** Carbon monoxide
4 detection shall be provided in dwelling units, sleeping units and classrooms that contain a fuel-
5 burning appliance or a fuel-burning fireplace.

6 **[F] 915.1.3 Forced-air furnaces.** Carbon monoxide detection shall be provided in dwelling
7 units, sleeping units and classrooms served by a fuel-burning, forced-air furnace.

8 **Exception:** Carbon monoxide detection shall not be required in dwelling units, sleeping
9 units and classrooms if carbon monoxide detection is provided in the first room or area
10 served by each main duct leaving the furnace, and the carbon monoxide alarm signals are
11 automatically transmitted to an approved location.

12 **[F] 915.1.4 Fuel-burning appliances outside of dwelling units, sleeping units and**
13 **classrooms.** Carbon monoxide detection shall be provided in dwelling units, sleeping units and
14 classrooms located in buildings that contain fuel-burning appliances or fuel-burning fireplaces.

15 **Exceptions:**

- 16 1. Carbon monoxide detection shall not be required in dwelling units, sleeping units and
17 classrooms where there are no communicating openings between the fuel-burning
18 appliance or fuel-burning fireplace and the dwelling unit, sleeping unit or classroom.
- 19 2. Carbon monoxide detection shall not be required in dwelling units, sleeping units and
20 classrooms where carbon monoxide detection is provided in one of the following
21 locations:
- 22 2.1. In an approved location between the fuel-burning appliance or fuel-burning
23 fireplace and the dwelling unit, sleeping unit or classroom.

1 2.2. On the ceiling of the room containing the fuel-burning appliance or fuel-burning
2 fireplace.

3 **[F] 915.1.5 Private garages.** Carbon monoxide detection shall be provided in dwelling units,
4 sleeping units and classrooms in buildings with attached private garages.

5 **Exceptions:**

- 6 1. Carbon monoxide detection shall not be required where there are no communicating
7 openings between the private garage and the dwelling unit, sleeping unit or classroom.
- 8 2. Carbon monoxide detection shall not be required in dwelling units, sleeping units and
9 classrooms located more than one story above or below a private garage.
- 10 3. Carbon monoxide detection shall not be required where the private garage connects to
11 the building through an open-ended corridor.
- 12 4. Where carbon monoxide detection is provided in an approved location between
13 openings to a private garage and dwelling units, sleeping units or classrooms, carbon
14 monoxide detection shall not be required in the dwelling units, sleeping units or
15 classrooms.

16 **[F] 915.1.6 Exempt garages.** For determining compliance with Section 915.1.5, an open
17 parking garage complying with Section 406.5 or an enclosed parking garage complying with
18 Section 406.6 shall not be considered a private garage.

19 **[W] [F] 915.2 Locations.** Where required by Section 915.1.1, carbon monoxide detection shall
20 be installed in the locations specified in Sections 915.2.1 through 915.2.3.

21 **[F] 915.2.1 Dwelling units.** Carbon monoxide detection shall be installed in dwelling units
22 outside of each separate sleeping area in the immediate vicinity of the bedrooms and on each
23 level of the dwelling. Where a fuel-burning appliance or a fuel-burning fireplace is located

1 within a bedroom or its attached bathroom, carbon monoxide detection shall be installed within
2 the bedroom.

3 **[F] 915.2.2 Sleeping units.** Carbon monoxide detection shall be installed in sleeping units.

4 **Exception:** Carbon monoxide detection shall be allowed to be installed outside of each
5 separate sleeping area in the immediate vicinity of the sleeping unit where the sleeping unit
6 or its attached bathroom does not contain a fuel-burning appliance or a fuel-burning fireplace
7 and is not served by a forced air furnace.

8 **[W] [F] 915.2.3 Group E occupancies.** When required by Section 915.1 in new buildings or
9 by Chapter 11 of the International Fire Code, ((C))carbon monoxide detection shall be installed
10 in classrooms in Group E occupancies. Carbon monoxide alarm signals shall be automatically
11 transmitted to an on-site location that is staffed by school personnel.

12 **Exceptions:**

- 13 1. Carbon monoxide alarm signals shall not be required to be automatically transmitted
14 to an on-site location that is staffed by school personnel in Group E occupancies with
15 an occupant load of ~~((30))~~ 50 or less.
- 16 2. Carbon monoxide alarm signals shall not be required to be automatically transmitted
17 to an on-site location that is staffed by school personnel in Group E occupancies
18 where an exception contained in Section 915.1 applies, or in Group E occupancies
19 where signals are transmitted to an off-site service monitored by a third party, such as
20 a service that monitors fire protection systems in the building.

21 **[F] 915.3 Detection equipment.** Carbon monoxide detection required by Sections 915.1 through
22 915.2.3 shall be provided by carbon monoxide alarms complying with Section 915.4 or carbon
23 monoxide detection systems complying with Section 915.5.

1 **[F] 915.4 Carbon monoxide alarms.** Carbon monoxide alarms shall comply with Sections
2 915.4.1 through 915.4.3.

3 **[F] 915.4.1 Power source.** Carbon monoxide alarms shall receive their primary power from
4 the building wiring where such wiring is served from a commercial source, and when primary
5 power is interrupted, shall receive power from a battery. Wiring shall be permanent and
6 without a disconnecting switch other than that required for overcurrent protection.

7 **Exception:** Where installed in buildings without commercial power, battery-powered carbon
8 monoxide alarms shall be an acceptable alternative.

9 **[F] 915.4.2 Listings.** Carbon monoxide alarms shall be listed in accordance with UL 2034.

10 **[F] 915.4.3 Combination alarms.** Combination carbon monoxide/smoke alarms shall be an
11 acceptable alternative to carbon monoxide alarms. Combination carbon monoxide/smoke
12 alarms shall be listed in accordance with UL 2034 and UL 217.

13 **[F] 915.5 Carbon monoxide detection systems.** Carbon monoxide detection systems shall be
14 an acceptable alternative to carbon monoxide alarms and shall comply with Sections 915.5.1
15 through 915.5.3.

16 **[F] 915.5.1 General.** Carbon monoxide detection systems shall comply with NFPA 720.
17 Carbon monoxide detectors shall be listed in accordance with UL 2075.

18 **[F] 915.5.2 Locations.** Carbon monoxide detectors shall be installed in the locations specified
19 in Section 915.2. These locations supersede the locations specified in NFPA 720.

20 **[F] 915.5.3 Combination detectors.** Combination carbon monoxide/smoke detectors installed
21 in carbon monoxide detection systems shall be an acceptable alternative to carbon monoxide
22 detectors, provided they are listed in accordance with UL 2075 and UL 268.

1 **[F] 915.6 Maintenance.** Carbon monoxide alarms and carbon monoxide detection systems shall
2 be maintained in accordance with the *International Fire Code*.

3 ***

4 Section 10. The following sections of Chapter 10 of the International Building Code,
5 2015 Edition, are amended as follows:

6 **CHAPTER 10**

7 **MEANS OF EGRESS**

8 ***

9 **SECTION 1003**

10 **GENERAL MEANS OF EGRESS**

11 ***

12 **1003.2 Ceiling height.** The *means of egress* shall have a ceiling height of not less than 7 feet 6
13 inches (2286 mm).

14 **Exceptions:**

15 1. ~~((Sloped e))~~ Ceilings in accordance with Section 1208.2.

16 ~~((2. Ceilings of *dwelling units* and *sleeping units* within residential occupancies in
17 accordance with Section 1208.2.))~~

18 2 ~~((3))~~. Allowable projections in accordance with Section 1003.3.

19 3 ~~((4))~~. *Stair* headroom in accordance with Section 1011.3.

20 4 ~~((5))~~. Door height in accordance with Section 1010.1.1.

21 5 ~~((6))~~. *Ramp* headroom in accordance with Section 1012.5.2.

22 6 ~~((7))~~. The clear height of floor levels in vehicular and pedestrian traffic areas of public
23 and private parking garages in accordance with Section 406.4.1.

1 7 ((8)). Areas above and below *mezzanine* floors in accordance with Section 505.2.

2 ***

3 **1003.5 Elevation change.** Where changes in elevation of less than 12 inches (305 mm) exist in
4 the *means of egress*, sloped surfaces shall be used. Where the slope is greater than one unit
5 vertical in 20 units horizontal (5-percent slope), *ramps* complying with Section 1012 shall be
6 used. Where the difference in elevation is 6 inches (152 mm) or less, the *ramp* shall be equipped
7 with either *handrails* or floor finish materials that contrast with adjacent floor finish materials.

8 **Exceptions:**

- 9 1. A single step with a maximum riser height of 7 inches (178 mm) is permitted for
10 buildings with occupancies in Groups F, H, R-2, R-3, S and U at exterior doors not
11 required to be *accessible* by Chapter 11.
- 12 2. A *stair* with a single riser or with two risers and a tread is permitted at locations not
13 required to be *accessible* by Chapter 11 and not within a stairway with two or more
14 flights of stairs, where the risers and treads comply with Section 1011.5, the minimum
15 depth of the tread is 13 inches (330 mm) and not less than one *handrail* complying with
16 Section 1014 is provided within 30 inches (762 mm) of the centerline of the normal
17 path of egress travel on the *stair*.
- 18 3. A step is permitted in *aisles* serving seating that has a difference in elevation less than
19 12 inches (305 mm) at locations not required to be *accessible* by Chapter 11, provided
20 that the risers and treads comply with Section 1029.13 and the *aisle* is provided with a
21 *handrail* complying with Section 1029.15.

1 Throughout a story in a Group I-2 occupancy, any change in elevation in portions of the
 2 *means of egress* that serve nonambulatory persons shall be by means of a *ramp* or sloped
 3 walkway.

4 ***

5 **SECTION 1004**

6 **OCCUPANT LOAD**

7 ***

| TABLE 1004.1.2 | |
|--|---|
| MAXIMUM FLOOR AREA ALLOWANCES PER OCCUPANT | |
| FUNCTION OF SPACE | OCCUPANT LOAD FACTOR^a |
| Accessory storage areas, mechanical equipment room ^b | 300 gross |
| Agricultural building | 300 gross |
| Aircraft hangars | 500 gross |
| Airport terminal | |
| Baggage claim | 20 gross |
| Baggage handling | 300 gross |
| Concourse | 100 gross |
| Waiting areas | 15 gross |
| Assembly | |
| Gaming floors (keno, slots, etc.) | 11 gross |
| Exhibit gallery and museum | 30 net |
| Assembly with fixed seats | See Section 1004.4 |
| Assembly without fixed seats | |
| Concentrated (chairs only—not fixed) | 7 net |
| Standing space | 5 net |
| Unconcentrated (tables and chairs) | 15 net |
| Bowling centers, allow 5 persons for each lane including 15 feet of runway, and for additional areas | 7 net |
| Business areas | |
| <u>Without sprinkler protection</u> | 100 gross |
| <u>With sprinkler protection</u> | 130 gross |
| <u>Commercial laboratories</u> | <u>100 gross</u> |
| Courtrooms—other than fixed seating areas | 40 net |
| Day care | 35 net |
| Dormitories | 50 gross |

| | |
|--|-----------------------|
| Educational Classroom area | 20 net |
| Shops, laboratories and other vocational room areas | 50 net |
| Exercise rooms | 50 gross |
| Group H-5 Fabrication and manufacturing areas | 200 gross |
| Industrial areas | 100 gross |
| Institutional areas Inpatient treatment areas | 240 gross |
| Outpatient areas | 100 gross |
| Sleeping areas | 120 gross |
| Kitchens, commercial | 200 gross |
| Library Reading rooms | 50 net |
| Stack area | 100 gross |
| Locker rooms | 50 gross |
| Mall buildings—covered and open | See Section 402.8.2 |
| Mercantile Storage, stock, shipping areas | 60 gross 300 gross |
| Parking garages | 200 gross |
| Residential | 200 gross |
| Skating rinks, swimming pools Rink and pool | 50 gross |
| Decks | 15 gross |
| Stages and platforms | 15 net |
| Warehouses | 500 gross |
| <p>For SI: 1 square foot = 0.0929 m², 1 foot = 304.8 mm. a. Floor area in square feet per occupant. b. For electrical equipment areas, see also Sections 110.26 and 110.32 through 110.34 of the Seattle Electrical Code.</p> | |

Interpretation I1004.1: The occupant load factor for occupied roofs is 15 net unless the construction documents indicate use other than unconcentrated assembly.

SECTION 1005

MEANS OF EGRESS SIZING

1 **1005.2 Minimum width based on component.** The minimum width, in inches (mm), of any
2 *means of egress* components shall be not less than that specified for such component, elsewhere
3 in this code. The width at any point in the path of egress travel shall not be less than the width
4 required for doors in Section 1010.

5 **Exceptions:**

- 6 1. Aisles and aisle accessways complying with Section 1018.
7 2. Corridors complying with Section 1020.2.
8 3. Stage stairways and catwalks complying with Section 410.6.

9 ***

10 **1005.6 Egress convergence.** Where the *means of egress* from stories above and below converge
11 at an intermediate level, the capacity of the *means of egress* from the point of convergence shall
12 be not less than the largest minimum width or the sum of the required capacities for the
13 *stairways* or *ramps* serving the two adjacent stories, whichever is larger.

14 **Exception:** The capacity necessary for parking uses need not be considered.

15 ***

16 **SECTION 1006**

17 **NUMBER OF EXITS AND EXIT ACCESS DOORWAYS**

18 ***

19

**TABLE 1006.2.1
SPACES WITH ONE EXIT OR EXIT ACCESS DOORWAY**

| OCCUPANCY | MAXIMUM OCCUPANT LOAD OF SPACE | MAXIMUM COMMON PATH OF EGRESS TRAVEL DISTANCE (feet) | | |
|-------------------------------|--------------------------------|--|---------|------------------------------|
| | | Without sprinkler System (feet) | | With Sprinkler System (feet) |
| | | Occupant Load | | |
| | | OL ≤ 30 | OL > 30 | |
| A ^c , E, M | 49 | 75 | 75 | 75 ^a |
| B | 49 | 100 | 75 | 100 ^a |
| F | 49 | 75 | 75 | 100 ^a |
| H-1, H-2, H-3 | 3 | NP | NP | 25 ^b |
| H-4, H-5 | 10 | NP | NP | 75 ^b |
| I-1, I-2 ^d , I-4 | 10 | NP | NP | 75 ^a |
| I-3 | 10 | NP | NP | 100 ^a |
| R-1 | 10 | NP | NP | 75 ^a |
| R-2 | 10 | NP | NP | 125 ^a |
| R-3 ^e | 10 | NP | NP | 125 ^a |
| (R-4) ^e | 10 | 75 | 75 | 125 ^a) |
| S ^f | 29 | 100 | 75 | 100 ^a |
| U | 49 | 100 | 75 | 75 ^a |

For SI: 1 foot = 304.8 mm. NP = Not Permitted.

- a. Buildings equipped throughout with an *automatic sprinkler system* in accordance with Section 903.3.1.1 or 903.3.1.2. See Section 903 for occupancies where *automatic sprinkler systems* are permitted in accordance with Section 903.3.1.2.
- b. Group H occupancies equipped throughout with an *automatic sprinkler system* in accordance with Section 903.2.5.
- c. For a room or space used for assembly purposes having *fixed seating*, see Section 1029.8.
- d. For the travel distance limitations in Group I-2, see Section 407.4.
- e. The length of *common path of egress travel* distance in a Group R-3 occupancy located in a mixed occupancy building or within a Group R-3 (~~(or R-4)~~) congregate living facility.
- f. The length of *common path of egress travel* distance in a Group S-2 *open parking garage* shall be not more than 100 feet.

1
2 **1006.3 Egress from stories or occupied roofs.** The *means of egress* system serving any *story* or
3 occupied roof shall be provided with the number of *exits* or access to *exits* based on the
4 aggregate *occupant load* served in accordance with this section. Horizontal exits shall not count

1 toward the required number of exits from the story or roof. The path of egress travel to an *exit*
2 shall not pass through more than one adjacent *story*.

3 **Note:** In high-rise buildings required to have an additional exit stairway by Section 403.5.2,
4 all exit stairways must be accessible to all tenants on a floor without having to pass through
5 another tenant space.

6 ***

7 **1006.3.2 Single exits.** A single *exit* or access to a single *exit* shall be permitted from any
8 *story* or occupied roof where one of the following conditions exists:

- 9 1. The *occupant load*, number of *dwelling units* and common path of egress travel
10 distance within the portion of the building served by the single exit does not exceed
11 the values in Table 1006.3.2(1) or 1006.3.2(2).
- 12 2. Rooms, areas and spaces complying with Section 1006.2.1 with *exits* that discharge
13 directly to the exterior at the *level of exit discharge*, are permitted to have one *exit* or
14 access to a single *exit*.
- 15 3. Parking garages where vehicles are mechanically parked shall be permitted to have one
16 *exit* or access to a single *exit*.
- 17 4. Group R-3 (~~and R-4~~) occupancies shall be permitted to have one *exit* or access to a
18 single *exit*.
- 19 5. Individual single-story or multistory *dwelling units* shall be permitted to have a single
20 exit or access to a single *exit* from the *dwelling unit* provided that both of the
21 following criteria are met:
 - 22 5.1. The *dwelling unit* complies with Section 1006.2.1 as a space with one *means of*
23 *egress*.

1 5.2. Either the *exit* from the *dwelling unit* discharges directly to the exterior at the *level*
2 *of exit discharge*, or the *exit access* outside the dwelling unit's entrance door
3 provides access to not less than two approved independent *exits*.

4 6. Occupied roofs with an occupant load of ten or less are permitted to have a single exit
5 or access to a single exit.

6 7. Not more than 5 stories of Group R-2 occupancy are permitted to be served by a single
7 exit under the following conditions:

8 7.1 The building has not more than six stories above grade plane.

9 7.2 The building does not contain a boarding house.

10 7.3 There shall be no more than four dwelling units on any floor.

11 7.4 The building shall be of not less than one-hour fire-resistive construction and

12 shall also be equipped throughout with an automatic sprinkler system in

13 accordance with Section 903.3.1.1. Residential-type sprinklers shall be used in

14 all habitable spaces in each dwelling unit.

15 7.5 There shall be no more than two single exit stairway conditions on the same
16 property.

17 7.6 An exterior stairway or interior exit stairway shall be provided. The interior exit

18 stairway, including any related exit passageway, shall be pressurized in

19 accordance with Section 909.20. Doors in the stairway shall swing into the

20 interior exit stairway regardless of the occupant load served, provided that doors

21 from the interior exit stairway to the building exterior are permitted to swing in

22 the direction of exit travel.

1 7.7 A corridor shall separate each dwelling unit entry/exit door from the door to an
2 interior exit stairway, including any related exit passageway, on each floor.

3 Dwelling unit doors shall not open directly into an interior exit stairway.

4 Dwelling unit doors are permitted to open directly into an exterior stairway.

5 7.8 There shall be no more than 20 feet (6096 mm) of travel to the exit stairway from
6 the entry/exit door of any dwelling unit.

7 7.9 Travel distance measured in accordance with Section 1017 shall not exceed 125
8 feet.

9 7.10 The exit shall not terminate in an egress court where the court depth exceeds the
10 court width unless it is possible to exit in either direction to the public way.

11 7.11 Elevators shall be pressurized in accordance with Section 909.21 or shall open
12 into elevator lobbies that comply with Section 713.14. Where approved by the
13 building official, natural ventilation is permitted to be substituted for
14 pressurization where the ventilation would prevent the accumulation of smoke or
15 toxic gases.

16 7.12 Other occupancies are permitted in the same building provided they comply with
17 all the requirements of this code. Other occupancies shall not communicate with
18 the Group R occupancy portion of the building or with the single-exit stairway.

19 **Exception:** Parking garages accessory to the Group R occupancy are
20 permitted to communicate with the exit stairway.

21 7.13 The exit serving the Group R occupancy shall not discharge through any other
22 occupancy, including an accessory parking garage.

7.14 There shall be no openings within 10 feet (3048 mm) of unprotected openings into the stairway other than required exit doors having a one-hour fire-resistance rating.

| TABLE 1006.3.2(2) STORIES WITH ONE EXIT OR ACCESS TO ONE EXIT FOR OTHER OCCUPANCIES | | | |
|--|--|---------------------------------|--|
| STORY | OCCUPANCY | MAXIMUM OCCUPANT LOAD PER STORY | MAXIMUM COMMON PATH OF EGRESS TRAVEL DISTANCE (feet) |
| First story above or below grade plane | A, B, E, F ^b , M, U | 49 | 75 |
| | H-2, H-3 | 3 | 25 |
| | H-4, H-5, I, R-1, R-2 ^{a, c} (, R-4)) | 10 | 75 |
| | S ^{b, d} | 29 | 75 |
| Second story above grade plane | B, F, M, S ^d | 29 | 75 |
| Third story above grade plane and higher | NP | NA | NA |

For SI: 1 foot = 304.8 mm. NP = Not Permitted.

NA = Not Applicable.

- a. Buildings classified as Group R-2 equipped throughout with an *automatic sprinkler system* in accordance with Section 903.3.1.1 or 903.3.1.2 and provided with *emergency escape and rescue openings* in accordance with Section 1030.
- b. Group B, F and S occupancies in buildings equipped throughout with an *automatic sprinkler system* in accordance with Section 903.3.1.1 shall have a maximum *exit access* travel distance of 100 feet.
- c. This table is used for R-2 occupancies consisting of *sleeping units*. For R-2 occupancies consisting of *dwelling units*, use Table 1006.3.2(1).
- d. The length of *exit access* travel distance in a Group S-2 *open parking garage* shall be not more than 100 feet.

SECTION 1007

EXIT AND EXIT ACCESS DOORWAY CONFIGURATION

1007.1 General. *Exits, exit access doorways, and exit access stairways and ramps* serving spaces, including individual building *stories*, shall be separated in accordance with the provisions

1 of this section. Interlocking or scissor stairs and stairways that share a wall with other interior
2 exit stairways shall be counted as one exit or exit access.

3 **1007.1.1 Two exits or exit access doorways.** Where two *exits, exit access doorways, exit*
4 *access stairways or ramps*, or any combination thereof, are required from any portion of the
5 *exit access*, they shall be placed a distance apart equal to not less than one-half of the length
6 of the maximum overall diagonal dimension of the building or area to be served measured in
7 a straight line between them. (~~Interlocking or scissor stairways shall be counted as one exit~~
8 ~~stairway.))~~

9 **Exceptions:**

- 10 1. Where interior *exit stairways or ramps* are interconnected by a 1-hour fire-
11 resistance-rated corridor conforming to the requirements of Section 1020, the
12 required exit separation shall be measured along the shortest direct line of travel
13 within the corridor.

14 **Interpretation I1007.1:** Exception 1 applies only where corridors have a one-hour
15 fire-resistance-rating even where Section 1020 would allow non-rated corridors.

- 16 2. Where a building is equipped throughout with an *automatic sprinkler system* in
17 accordance with Section 903.3.1.1 or 903.3.1.2, the separation distance shall be not
18 less than one-third of the length of the maximum overall diagonal dimension of the
19 area served.
- 20 3. Where it is not practical to separate exits by one-half the diagonal dimension, exits
21 from retail and office tenant spaces in Group B and M occupancies and within
22 dwelling units shall be as far apart as reasonably practicable as determined by the
23 building official.

Note: Interior exit stairways in high-rise buildings shall also meet the requirements of Section 403.5.1.

1007.1.1.1 Measurement point. The separation distance required in Section 1007.1.1 shall be measured in accordance with the following:

1. The separation distance to *exit* or *exit access doorways* shall be measured to any point along the width of the doorway.
2. The separation distance to *exit access stairways* shall be measured to any point along the width of the closest riser.
3. The separation distance to *exit access ramps* shall be measured to any point along the width of the start of the ramp run.

Interpretation I1007.1.1.1: In items 1-3, separation distance is permitted to be measured to the farthest point.

SECTION 1008

MEANS OF EGRESS ILLUMINATION

1008.1 Means of egress illumination. Illumination shall be provided at every point in the *means of egress* in accordance with Section 1008.2. Under emergency power, means of egress illumination shall comply with Section 1008.3.

1008.2 Illumination required. The *means of egress* serving a room or space shall be illuminated at all times that the room or space is occupied.

Exceptions:

1. Occupancies in Group U.

1 2. *Aisle accessways* in Group A.

2 3. *Dwelling units and sleeping units* in Groups R-1, R-2 and R-3.

3 4. *Sleeping units* of Group I occupancies.

4 **1008.2.1 Illumination level under normal power.** The *means of egress* illumination level
5 shall be not less than 1 footcandle (11 lux) at the walking surface. Luminaires shall be
6 installed whenever exit signs are required by Section 1013.

7 **Exception:** For auditoriums, theaters, concert or opera halls and similar assembly
8 occupancies, the illumination at the walking surface is permitted to be reduced during
9 performances by one of the following methods provided that the required illumination is
10 automatically restored upon activation of a premises' fire alarm system:

- 11 1. Externally illuminated walking surfaces shall be permitted to be illuminated to not
12 less than 0.2 footcandle (2.15 lux).
- 13 2. Steps, landings and the sides of ramps shall be permitted to be marked with self-
14 luminous materials in accordance with Sections 1025.2.1, 1025.2.2 and 1025.2.4
15 by systems listed in accordance with UL 1994.

16 **1008.2.2 Exit discharge.** In Group I-2 occupancies where two or more exits are required, on
17 the exterior landings required by Section 1010.6.1, means of egress illumination levels for
18 the exit discharge shall be provided such that failure of any single lighting unit shall not
19 reduce the illumination level on that landing to less than 1 footcandle (11 lux).

Code Alternate CA1008.2: Compliance with the following paragraphs will be deemed to
satisfy the requirement for means of egress illumination at every point in the means of
egress. Means of egress illumination systems that comply with this Code Alternate shall
also comply with Section 1008.3.

1. Location and fixture placement. Means of egress illumination shall be located in stairways, corridors, halls, passenger elevator cars, lobbies, rooms with an occupant load of 100 or more, and other areas required to provide safe egress from the premises and immediately outside of the building exit when required by the building official. Fixtures shall be installed to not less than the following schedule:

- | | |
|--|---------------------------------------|
| 1.1 Interior and exterior stairways and landings and outside building exit | At least one per landing |
| 1.2 Corridors and halls and designated means of egress paths in parking garages | At least one for each 40 lineal feet |
| 1.3 Lobbies, vestibules, foyers, elevator cars and other similar areas as required | At least one for each 250 square feet |
| 1.4 Warehouses | See Item 2 below. |

These fixtures are permitted to be included in the watts per square foot calculation for means of egress illumination.

2. Amount of Illumination. Where means of egress illumination is required, illumination shall be provided at the rate of 0.1 watts of fluorescent or 0.05 watts of LED illumination per square foot of area. Installations using incandescent lamps shall have a minimum wattage of at least 3 times the fluorescent requirements. Use of other light sources is subject to the approval of the building official.

Exceptions:

1. In warehouses, the allowable minimum illumination is permitted to be 0.1 watt per square foot (0.03 watts for fluorescent or 0.02 watts for LED) provided fixtures are placed either:

1.1 Where means of egress pathways are not designated, fixtures shall be placed to cover an area not larger than 1,600 square feet, or

1.2 Where means of egress pathways are designated, fixtures shall be placed at least one for every 40 lineal feet.

2. In theaters, auditoriums or other places of assembly where motion pictures or other projections are made by means of directed light, the minimum allowable illumination is permitted to be reduced to 0.05 watts per square foot of floor area (0.02 watts for fluorescent or 0.01 watts for LED). The higher level of required illumination shall be automatically restored upon activation of a premises fire alarm system where such system is provided.

3. In Groups B, F-1, M and S-1 occupancies, when approved by the building official, the minimum allowable illumination in the exit access is permitted to be reduced to 0.05 watts per square foot (0.02 watts for fluorescent or 0.01 watts for LED) of floor area.

4. In Group B occupancies and open parking garages, when approved by the building official, the illumination is permitted to be eliminated when within 50 feet of a window wall or open side and where light is not totally obscured.

Means of egress illumination fixtures shall be spaced and designed to give adequate distribution of light for safe egress and so that the failure of any individual lighting element,

such as the burning out of a light bulb, will not leave any space in total darkness.

Illumination from battery-operated fixtures shall provide the same level of illumination required for hard-wired fixtures.

1 **1008.3 Power supply (~~(Emergency power)~~) for illumination.** The power supply for means of
2 egress illumination shall normally be provided by the premises' electrical supply.

3 **1008.3.1 General.** In the event of power supply failure in rooms and spaces that require two
4 or more means of egress, an emergency (~~(electrical)~~) power system shall automatically
5 illuminate all of the following areas:

- 6 1. *Aisles.*
- 7 2. *Corridors.*
- 8 3. *Exit access stairways and ramps.*

9 ***

10 SECTION 1009

11 ACCESSIBLE MEANS OF EGRESS

12 **[W] 1009.1 Accessible means of egress required.** *Accessible means of egress* shall comply with
13 this section. *Accessible* spaces shall be provided with not less than one *accessible means of*
14 *egress*. Where more than one *means of egress* are required by Section 1006.2 or 1006.3 from any
15 *accessible* space, each *accessible* portion of the space shall be served by not less than two
16 *accessible means of egress*.

17 **Exceptions:**

- 18 1. *Accessible means of egress* are not required to be provided in existing buildings.
- 19 2. One *accessible means of egress* is required from an *accessible mezzanine* level in
20 accordance with Section 1009.3, 1009.4 or 1009.5.

1 3. In assembly areas with ramped aisles or stepped aisles, one accessible means of egress
2 is permitted where the common path of egress travel is accessible and meets the
3 requirements in Section 1029.8.

4 4. In parking garages, accessible means of egress are not required to serve parking areas
5 that do not contain accessible parking spaces.

6 **1009.2 Continuity and components.** Each required accessible *means of egress* shall be
7 continuous to a *public way* and shall consist of one or more of the following components:

- 8 1. *Accessible routes* complying with Section 1104.
- 9 2. *Interior exit stairways* complying with Sections 1009.3 and 1023.
- 10 3. *Exit access stairways* complying with Sections 1009.3 and 1019.3 or 1019.4.
- 11 4. *Exterior exit stairways* complying with Sections 1009.3 and 1027 and serving levels other
12 than the *level of exit discharge*.
- 13 5. Elevators complying with Section 1009.4.

14 **Interpretation I1009.2a:** An exit passageway is not required on the level of exit
15 discharge to connect the elevator with the exterior exit door.

- 16 6. Platform lifts complying with Section 1009.5.
- 17 7. *Horizontal exits* complying with Section 1026.
- 18 8. *Ramps* complying with Section 1012.
- 19 9. *Areas of refuge* complying with Section 1009.6.
- 20 10. Exterior areas for assisted rescue complying with Section 1009.7 serving exits at the *level*
21 of *exit discharge*.

1 **1009.2.1 Elevators required.** In buildings where a required *accessible* floor is four or more
2 *stories* above or below a *level of exit discharge*, not less than one required accessible *means*
3 *of egress* shall be an elevator complying with Section 1009.4.

4 **Interpretation I1009.2b:** The level of exit discharge is not counted when determining
5 whether an accessible floor is four stories above or below a level of exit discharge. See
6 Figure 1009.2.b.

7 **Exceptions:**

8 1. In buildings equipped throughout with an *automatic sprinkler system* installed in
9 accordance with Section 903.3.1.1 or 903.3.1.2, the elevator shall not be required on
10 floors provided with a *horizontal exit* and located at or above the *levels of exit*
11 *discharge*.

12 2. In buildings equipped throughout with an *automatic sprinkler system* installed in
13 accordance with Section 903.3.1.1 or 903.3.1.2, the elevator shall not be required on
14 floors provided with a *ramp* conforming to the provisions of Section 1012.

15 **Interpretation I1009.2c:** In exception 2, the ramp shall be part of an accessible means
16 of egress.

1

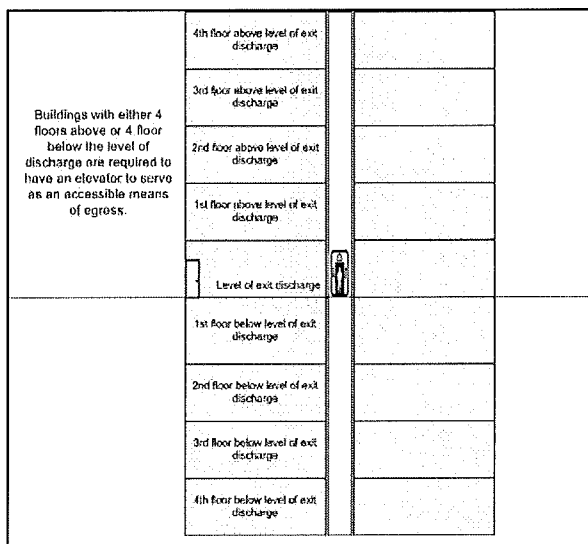

Figure 1009.2.b

2

3

4

5

6

7

8

9

10

11

12

13

14

15

16

1009.4 Elevators. In order to be considered part of an accessible *means of egress*, an elevator shall comply with the emergency operation and signaling device requirements of Section 2.27 of ASME A17.1. ((Standby)) An emergency or legally required standby power system shall be provided in accordance with Chapter 27 and ((Section 3003)) the Seattle Electrical Code for the for operation of the elevator, the shunt trip and lighting for elevator cars, control rooms, machine rooms, and machinery spaces. The elevator shall be accessed from an *area of refuge* complying with Section 1009.6.

Exceptions:

1. *Areas of refuge* are not required at the elevator in *open parking garages*.
2. *Areas of refuge* are not required in buildings and facilities equipped throughout with an *automatic sprinkler system* installed in accordance with Section 903.3.1.1 or 903.3.1.2.
3. *Areas of refuge* are not required at elevators not required to be located in a shaft in accordance with Section 712.

1 4. *Areas of refuge* are not required at elevators serving *smoke-protected assembly seating*
2 areas complying with Section 1029.6.2.

3 5. *Areas of refuge* are not required for elevators accessed from a refuge area in
4 conjunction with a *horizontal exit*.

5 **1009.5 Platform lifts.** Platform lifts shall be permitted to serve as part of an accessible *means of*
6 *egress* where allowed as part of a required *accessible route* in Section 1109.8 except for Item 10.

7 ((Standby)) A legally required standby power system for the platform lift shall be provided in
8 accordance with Chapter 27.

9 ***

10 **[W] 1009.8.1 System requirements.** Two-way communication systems shall provide
11 communication between each required location and the *fire command center* or a central
12 control point location *approved* by the fire department. Where the central control point is not
13 a *constantly attended location*, a two-way communication system shall have a timed
14 automatic telephone dial-out capability to a monitoring location ((~~or 9-1-1~~)). The two-way
15 communication system shall include both audible and visible signals. The two-way
16 communication system shall have a battery backup or an approved alternate source of power
17 that is capable of 90 minutes use upon failure of the normal power source.

18 ***

19 SECTION 1010

20 DOORS, GATES AND TURNSTILES

21 **1010.1 Doors.** *Means of egress* doors shall meet the requirements of this section. Doors serving a
22 *means of egress* system shall meet the requirements of this section and Section 1022.2. Doors

1 provided for egress purposes in numbers greater than required by this code shall meet the
2 requirements of this section. See Section 3201 for doors swinging over public property.

3 *Means of egress* doors shall be readily distinguishable from the adjacent construction and
4 finishes such that the doors are easily recognizable as doors. Mirrors or similar reflecting
5 materials shall not be used on *means of egress* doors. *Means of egress* doors shall not be
6 concealed by curtains, drapes, decorations or similar materials.

7 ***

8 **1010.1.5 Floor elevation.** There shall be a floor or landing on each side of a door. Such floor
9 or landing shall be at the same elevation on each side of the door. Landings shall be level
10 except for exterior landings, which are permitted to have a slope not to exceed 0.25 unit
11 vertical in 12 units horizontal (2-percent slope).

12 **Exceptions:**

- 13 1. Doors serving individual *dwelling units* in Groups R-2 and R-3 where the
14 following apply:
- 15 1.1. A door is permitted to open at the top step of a ~~(n interior)~~ *flight of stairs*,
16 provided the door does not swing over the top step.
- 17 1.2. Screen doors and storm doors are permitted to swing over *stairs* or landings.
- 18 2. Exterior doors as provided for in Section 1003.5, Exception 1, and Section 1022.2,
19 which are not on an *accessible route*.
- 20 3. In Group R-3 occupancies not required to be *Accessible units*, *Type A units* or *Type*
21 *B units*, the landing at an exterior doorway shall be not more than 7 3/4 inches (197
22 mm) below the top of the threshold, provided the door, other than an exterior storm
23 or screen door, does not swing over the landing.

1 4. Variations in elevation due to differences in finish materials, but not more than 1/2
2 inch (12.7 mm).

3 5. Exterior decks, patios or balconies that are part of *Type B dwelling units*, have
4 impervious surfaces and that are not more than 4 inches (102 mm) below the
5 finished floor level of the adjacent interior space of the dwelling unit.

6 6. Doors serving equipment spaces not required to be *accessible* in accordance with
7 Section 1103.2.9 and serving an occupant load of five or less shall be permitted to
8 have a landing on one side to be not more than 7 inches (178 mm) above or below
9 the landing on the egress side of the door.

10 **1010.1.6 Landings at doors.** Landings shall have a width not less than the width of the
11 *stairway* or the door, whichever is greater. Doors in the fully open position shall not reduce a
12 required dimension by more than 7 inches (178 mm). Where a landing serves an *occupant*
13 *load* of 50 or more, doors in any position shall not reduce the landing to less than one-half its
14 required width. When doors open over landings, doors in any position shall not reduce the
15 landing length to less than 12 inches (305 mm). Landings shall have a length measured in
16 the direction of travel of not less than 44 inches (1118 mm).

17 **Exception:** Landing length in the direction of travel in Groups R-3 and U and within
18 individual units of Group R-2 need not exceed 36 inches (914 mm)

19 **Interpretation I1010.1.6:** Landing length, width and slope shall be measured as specified
20 in Section 1011.6 and 1011.7.1. See Figures 1010.1.6(1), 1010.1.6(2) and 1010.1.6(3) for
21 illustrations of the requirements of this section.

1

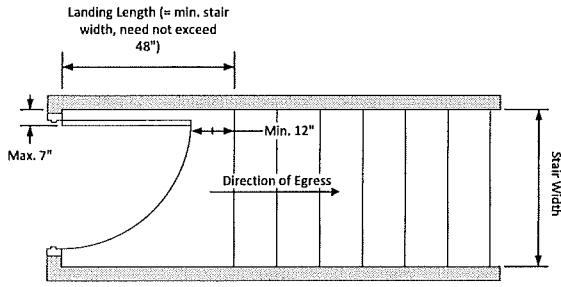

Figure 1010.1.6(1)
Landing dimensions only

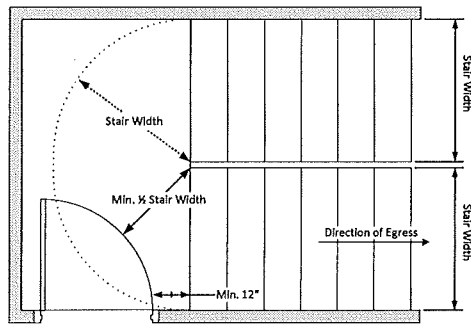

Figure 1008.1.6(2)
(Landing Dimensions Only)

2

3

4

5

6

7

Figure 1010.1.6(2)
Landing dimensions only

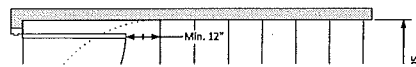

Figure 1010.1.6(3)
Landing dimensions only

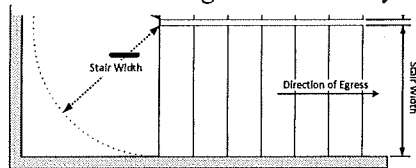

Figure 1008.1.6(3)
(Landing Dimensions Only)

1 ***

2 **1010.1.9 Door operations.** Except as specifically permitted by this section, egress doors
3 shall be readily openable from the egress side without the use of a key or special knowledge
4 or effort.

5 **Note:** Stairway doors shall also comply with Section 1010.1.9.11.

6 ***

7 **1010.1.9.3 Locks and latches.** Locks and latches shall be permitted to prevent operation
8 of doors where any of the following exist:

- 9 1. Places of detention or restraint as approved by the building official.
- 10 2. In buildings in occupancy Group A having an *occupant load* of 300 or less, Groups
11 B, F, M and S, and in *places of religious worship*, the main door or doors are
12 permitted to be equipped with key-operated locking devices from the egress side
13 provided:
 - 14 2.1. The locking device is readily distinguishable as locked.
 - 15 2.2. A readily visible durable sign is posted on the egress side on or adjacent to the
16 door stating: THIS DOOR TO REMAIN UNLOCKED ((WHEN THIS SPACE
17 IS OCCUPIED)) DURING BUSINESS HOURS. The sign shall be in letters 1
18 inch (25 mm) high on a contrasting background.
 - 19 2.3. The use of the key-operated locking device is revokable by the *building official*
20 for due cause.
- 21 3. Where egress doors are used in pairs, *approved* automatic flush bolts shall be
22 permitted to be used, provided that the door leaf having the automatic flush bolts

1 does not have a doorknob or surface-mounted hardware on the egress side of the
2 door.

3 4. Doors from individual *dwelling* or *sleeping units* of Group R occupancies having
4 an *occupant load* of 10 or less are permitted to be equipped with a night latch, dead
5 bolt or security chain, provided such devices are openable from the inside without
6 the use of a key or tool.

7 5. *Fire doors* after the minimum elevated temperature has disabled the unlatching
8 mechanism in accordance with *listed fire door* test procedures.

9 [W] 6. Approved, listed locks without delayed egress shall be permitted in boarding
10 homes licensed by Washington state, provided that:

11 6.1. The clinical needs of one or more patients require specialized security
12 measures for their safety.

13 6.2. The doors unlock upon actuation of the automatic sprinkler system or
14 automatic fire detection system.

15 6.3. The doors unlock upon loss of electrical power controlling the lock or lock
16 mechanism.

17 6.4. The lock shall be capable of being deactivated by a signal from a switch
18 located in an approved location.

19 6.5. There is a system, such as a keypad and code, in place that allows visitors,
20 staff persons and appropriate residents to exit. Instructions for exiting shall be
21 posted within six feet of the door.

22 7. Doors from elevator lobbies providing access to exits are permitted to be locked
23 during or after business hours where items 7.1 through 7.5 are satisfied.

1 7.1. The lobby doors shall unlock automatically upon fire alarm.

2 7.2. The lobby doors shall unlock automatically upon power loss.

3 7.3. The alarm system shall include smoke detection in the elevator lobby and at
4 least two detectors on the tenant side within 15 feet of the door;

5 7.4. Access through the tenant portion of the building to both exits shall be
6 unobstructed; and

7 7.5. The building shall have an automatic sprinkler system throughout in
8 accordance with Section 903.3.1.1 or 903.3.1.2.

9 **1010.1.9.4 Bolt locks.** Manually operated flush bolts or surface bolts are not permitted.

10 **Exceptions:**

11 1. On doors not required for egress in individual *dwelling units* or *sleeping units*.

12 2. Where a pair of doors serves a storage or equipment room, manually operated
13 edge- or surface-mounted bolts or self-latching flush bolts are permitted on the
14 inactive leaf.

15 3. Where a pair of doors serves an *occupant load* of less than 50 persons in a
16 Group B, F or S occupancy, manually operated edge- or surface-mounted bolts
17 are permitted on the inactive leaf. The inactive leaf shall not contain doorknobs,
18 panic bars or similar operating hardware.

19 4. Where a pair of doors serves a Group B, F or S occupancy, manually operated
20 edge- or surface-mounted bolts are permitted on the inactive leaf provided such
21 inactive leaf is not needed to meet egress capacity requirements and the building
22 is equipped throughout with an *automatic sprinkler system* in accordance with

1 Section 903.3.1.1. The inactive leaf shall not contain doorknobs, panic bars or
2 similar operating hardware.

3 5. Where a pair of doors serves patient care rooms in Group I-2 occupancies, self-
4 latching edge- or surface-mounted bolts are permitted on the inactive leaf
5 provided that the inactive leaf is not needed to meet egress capacity
6 requirements and the inactive leaf shall not contain doorknobs, panic bars or
7 similar operating hardware.

8 ***

9 **[W]** (~~1010.1.9.5.1 Closet and bathroom doors in Group R-4 occupancies. In~~
10 ~~Group R-4 occupancies, closet doors that latch in the closed position shall be~~
11 ~~openable from inside the closet, and bathroom doors that latch in the closed position~~
12 ~~shall be capable of being unlocked from the ingress side.))~~

13 **[W] 1010.1.9.6 Controlled egress doors in Groups I-1 and I-2.** Electric locking
14 systems, including electromechanical locking systems and electromagnetic locking
15 systems, shall be permitted to be locked in the means of egress in Group I-1 or I-2
16 occupancies where the clinical needs of persons receiving care require their containment.
17 Controlled egress doors shall be permitted in such occupancies where the building is
18 equipped throughout with an *automatic sprinkler system* in accordance with Section
19 903.3.1.1 or an *approved automatic smoke or heat detection system* installed in
20 accordance with Section 907, provided that the doors are installed and operate in
21 accordance with all of the following:

- 22 1. The door locks shall unlock on actuation of the *automatic sprinkler system* or
23 *automatic fire detection system*.

- 1 2. The door locks shall unlock on loss of power controlling the lock or lock
- 2 mechanism.
- 3 3. The door locking system shall be installed to have the capability of being unlocked
- 4 by a switch located at the *fire command center*, a nursing station or other approved
- 5 location. The switch shall directly break power to the lock.
- 6 4. A building occupant shall not be required to pass through more than one door
- 7 equipped with a controlled egress locking system before entering an exit.
- 8 5. The procedures for unlocking the doors shall be described and approved as part of
- 9 the emergency planning and preparedness required by Chapter 4 of the
- 10 *International Fire Code*.
- 11 6. There is a system, such as a keypad and code, in place that allows visitors, staff
- 12 persons and appropriate residents to exit. Instructions for exiting shall be posted
- 13 within six feet of the door.
- 14 (~~6. All clinical staff shall have the keys, codes or other means necessary to operate~~
- 15 ~~the locking systems.))~~
- 16 7. Emergency lighting shall be provided at the door.
- 17 8. The door locking system units shall be listed in accordance with UL 294.

Exceptions:

- 19 1. Items 1 through 4 and 6 shall not apply to doors to areas occupied by persons
- 20 who, because of clinical needs, require restraint or containment as part of the
- 21 function of a psychiatric treatment area provided that all clinical staff shall
- 22 have the keys, codes or other means necessary to operate the locking devices.

1 2. Items 1 through 4 shall not apply to doors to areas where a *listed* egress control
2 system is utilized to reduce the risk of child abduction from nursery and
3 obstetric areas of a Group I-2 hospital.

4 **1010.1.9.7 Delayed egress.** Delayed egress locking systems shall be permitted to be
5 installed on doors serving any occupancy except Group A, E and H in buildings that are
6 equipped throughout with an *automatic sprinkler system* in accordance with Section
7 903.3.1.1 or an *approved automatic smoke* or *heat detection system* installed in
8 accordance with Section 907. Delayed egress locks are permitted in libraries in both
9 Group A and E occupancies in locations other than at main exit doors, and in Group E
10 day care occupancies. The locking system shall be installed and operated in accordance
11 with all of the following:

- 12 1. The delay electronics of the delayed egress locking system shall deactivate upon
13 actuation of the *automatic sprinkler system* or *automatic fire detection system*,
14 allowing immediate, free egress.
- 15 2. The delay electronics of the delayed egress locking system shall deactivate upon
16 loss of power controlling the lock or lock mechanism, allowing immediate free
17 egress.
- 18 3. The delayed egress locking system shall have the capability of being deactivated at
19 the *fire command center* and other *approved* locations.
- 20 4. An attempt to egress shall initiate an irreversible process that shall allow such
21 egress in not more than 15 seconds when a physical effort to exit is applied to the
22 egress side door hardware for not more than 3 seconds. Initiation of the irreversible
23 process shall activate an audible signal in the vicinity of the door. Once the delay

1 electronics have been deactivated, rearming the delay electronics shall be by
2 manual means only.

3 **Exception:** Where approved, a delay of not more than 30 seconds is permitted on
4 a delayed egress door.

5 5. The egress path from any point shall not pass through more than one delayed
6 egress locking system.

7 **Exception:** In Group I-2 or I-3 occupancies, the egress path from any point in the
8 building shall pass through not more than two delayed egress locking systems
9 provided the combined delay does not exceed 30 seconds.

10 6. A sign shall be provided on the door and shall be located above and within 12
11 inches (305 mm) of the door exit hardware:

12 6.1. For doors that swing in the direction of egress, the sign shall read: PUSH
13 UNTIL ALARM SOUNDS. DOOR CAN BE OPENED IN 15 [30] SECONDS.

14 6.2. For doors that swing in the opposite direction of egress, the sign shall read:
15 PULL UNTIL ALARM SOUNDS. DOOR CAN BE OPENED IN 15 [30]
16 SECONDS.

17 6.3. The sign shall comply with the visual character requirements in ICC A117.1.

18 **Exception:** Where approved, in Group I occupancies, the installation of a sign is
19 not required where care recipients who because of clinical needs require restraint
20 or containment as part of the function of the treatment area.

21 7. Emergency lighting shall be provided on the egress side of the door.

22 8. The delayed egress locking system units shall be listed in accordance with UL 294.

23 ***

- 1 2. This section shall not apply to doors arranged in accordance with Section
2 403.5.3.
- 3 3. In *stairways* serving not more than four stories, doors are permitted to be
4 locked from the side opposite the egress side, provided they are openable from
5 the egress side and capable of being unlocked simultaneously without
6 unlatching upon a signal from the *fire command center*, if present, or a signal
7 by emergency personnel from a single location inside the main entrance to the
8 building.
- 9 4. *Stairway exit* doors shall be openable from the egress side and shall only be
10 locked from the opposite side in Group B, F, M and S occupancies where the
11 only interior access to the tenant space is from a single *exit stairway* where
12 permitted in Section 1006.3.2.
- 13 5. *Stairway exit* doors shall be openable from the egress side and shall only be
14 locked from the opposite side in Group R-2 occupancies where the only
15 interior access to the *dwelling unit* is from a single *exit stairway* where
16 permitted in Section 1006.3.2.
- 17 6. In stairways serving more than four stories in non-high-rise buildings, doors are
18 permitted to be locked from the side opposite the egress side, provided they are
19 openable from the egress side and capable of being unlocked simultaneously
20 without unlatching upon a signal from the fire command center, if present, or a
21 signal by emergency personnel from a single location inside the main entrance
22 to the building. A communication system that complies with Section 403.5.3.1
23 shall be provided.

1 ***

2 **SECTION 1011**

3 **STAIRWAYS**

4 ***

5 **1011.2 Width and capacity.** The required capacity of *stairways* shall be determined as specified
6 in Section 1005.1, but the minimum width shall be not less than 44 inches (1118 mm). See
7 Section 1009.3 for accessible *means of egress stairways*.

8 **Exceptions:**

- 9 1. *Stairways* serving an *occupant load* of less than 50 shall have a width of not less than
10 36 inches (914 mm).
- 11 2. *Spiral stairways* as provided for in Section 1011.10.
- 12 3. Where an incline platform lift or stairway chairlift is installed on *stairways* serving
13 occupancies in Group R-3, or within *dwelling units* in occupancies in Group R-2, a
14 clear passage width not less than 20 inches (508 mm) shall be provided. Where the
15 seat and platform can be folded when not in use, the distance shall be measured from
16 the folded position.
- 17 4. Stairways that are designed exclusively for circulation.

18 ***

19 **1011.5.2 Riser height and tread depth.** *Stair* riser heights shall be 7 inches (178 mm)
20 maximum and 4 inches (102 mm) minimum. The riser height shall be measured vertically
21 between the *nosings* of adjacent treads. Rectangular tread depths shall be 11 inches (279 mm)
22 minimum measured horizontally between the vertical planes of the foremost projection of
23 adjacent treads and at a right angle to the tread's *nosing*. *Winder* treads shall have a minimum

1 tread depth of 11 inches (279 mm) between the vertical planes of the foremost projection of
2 adjacent treads at the intersections with the walkline and a minimum tread depth of 10 inches
3 (254 mm) within the clear width of the *stair*.

4 **Exceptions:**

- 5 1. *Spiral stairways* in accordance with Section 1011.10.
- 6 2. *Stairways* connecting stepped *aisles* to cross *aisles* or concourses shall be permitted
7 to use the riser/tread dimension in Section 1029.13.2.
- 8 3. In Group R-3 occupancies; within *dwelling units* in Group R-2 occupancies; and in
9 Group U occupancies that are accessory to a Group R-3 occupancy or accessory to
10 individual *dwelling units* in Group R-2 occupancies; the maximum riser height shall
11 be 7¾ inches (197 mm); the minimum tread depth shall be 10 inches (254 mm);
12 the minimum *winder* tread depth at the walkline shall be 10 inches (254 mm); and
13 the minimum *winder* tread depth shall be 6 inches (152 mm). A *nosing* projection
14 not less than ¾ inch (19.1 mm) but not more than 1¼ inches (32 mm) shall be
15 provided on *stairways* with solid risers where the tread depth is less than 11 inches
16 (279 mm).
- 17 4. See ((~~Section 403.1.0f~~)) the *International Existing Building Code* for the
18 replacement of existing *stairways*.
- 19 5. In Group I-3 facilities, *stairways* providing access to guard towers, observation
20 stations and control rooms, not more than 250 square feet (23 m2) in area, shall be
21 permitted to have a maximum riser height of 8 inches (203 mm) and a minimum
22 tread depth of 9 inches (229 mm).

23 ***

1 2. Curb ramps shall comply with ICC A117.1.

2 3. Vehicle ramps in parking garages for pedestrian *exit access* shall not be required to
3 comply with Sections 1012.3 through 1012.10 where they are not an *accessible route*
4 serving *accessible* parking spaces, other required *accessible* elements or part of an
5 *accessible means of egress*.

6 4. In a parking garage where one accessible means of egress serving accessible parking
7 spaces or other accessible elements is provided, a second accessible means of egress
8 serving that area shall be permitted to include a vehicle ramp that does not comply with
9 Sections 1012.4, 1012.5 and 1012.8. A landing complying with Sections 1012.6.1 and
10 1012.6.4 shall be provided at any change of direction in the accessible means of egress.

11 ***

12 **SECTION 1013**

13 **EXIT SIGNS**

14 **1013.1 Where required.** *Exits* and *exit access* doors shall be marked by an *approved* exit sign
15 readily visible from any direction of egress travel. The path of egress travel to *exits* and within
16 *exits* shall be marked by readily visible exit signs to clearly indicate the direction of egress travel
17 in cases where the *exit* or the path of egress travel is not immediately visible to the occupants.
18 Intervening *means of egress* doors within *exits* shall be marked by exit signs. Exit sign placement
19 shall be such that no point in an *exit access corridor* or *exit passageway* is more than 100 feet
20 (30 480 mm) or the *listed* viewing distance for the sign, whichever is less, from the nearest
21 visible exit sign. Exit signs shall be located at any other location determined by the building
22 official to be necessary to clearly indicate the direction of egress.

1 not less than 3/8 inch (9.5 mm). Signs larger than the minimum established in this section
2 shall have letter widths, strokes and spacing in proportion to their height.

3 The word "EXIT" shall be in high contrast with the background and shall be clearly
4 discernible when the means of exit sign illumination is or is not energized. If a chevron
5 directional indicator is provided as part of the exit sign, the construction shall be such that the
6 direction of the chevron directional indicator cannot be readily changed.

7 **Exception:** Existing exit signs with letters at least 5 inches (127 mm) in height are
8 permitted to be reused.

9 ***

10 **1013.7 Not-an-exit warnings.** Placards reading "NOT AN EXIT" shall be installed at all
11 doorways, passageways or stairways which are not exits, exit accesses or exit discharges, and
12 which may be mistaken for an exit. A sign indicating the use of the doorway, passageway or
13 stairway, such as "TO BASEMENT", "STORE ROOM", "LINEN CLOSET", is permitted in
14 lieu of the "NOT AN EXIT" sign.

15 ***

16 SECTION 1015

17 GUARDS

18 ***

19 **1015.6 ((Mechanical-e))Equipment, systems and devices.** *Guards* shall be provided where
20 various components that require service are located within 10 feet (3048 mm) of a roof edge or
21 open side of a walking surface and such edge or open side is located more than 30 inches (762
22 mm) above the floor, roof or grade below. The *guard* shall extend not less than 30 inches (762

1 mm) beyond each end of such components. The *guard* shall be constructed so as to prevent the
2 passage of a sphere 21 inches (533 mm) in diameter.

3 **Exception:** *Guards* are not required where permanent fall arrest/restraint anchorage
4 connector devices that comply with ANSI/ASSE Z 359.1 are affixed for use during the entire
5 roof covering lifetime. The devices shall be reevaluated for possible replacement when the
6 entire roof covering is replaced. The devices shall be placed not more than 10 feet (3048 mm)
7 on center along hip and ridge lines and placed not less than 10 feet (3048 mm) from the roof
8 edge or open side of the walking surface.

9 ***

10 SECTION 1016

11 EXIT ACCESS

12 ***

13 **1016.2 Egress through intervening spaces.** Egress through intervening spaces shall comply
14 with this section.

15 1. *Exit access* through an enclosed elevator lobby is permitted. Access to not less than one of
16 the required *exits* shall be provided without travel through the enclosed elevator lobbies
17 required by Section ((3006)) 713.14. Where the path of exit access travel passes through an
18 enclosed elevator lobby, the level of protection required for the enclosed elevator lobby is
19 not required to be extended to the *exit* unless direct access to an *exit* is required by other
20 sections of this code.

21 2. Egress from a room or space shall not pass through adjoining or intervening rooms or
22 areas, except where such adjoining rooms or areas and the area served are accessory to one

1 or the other, are not a Group H occupancy and provide a discernible path of egress travel to
2 an *exit*.

3 **Exception:** *Means of egress* are not prohibited through adjoining or intervening rooms or
4 spaces in a Group H, S or F occupancy where the adjoining or intervening rooms or
5 spaces are the same or a lesser hazard occupancy group.

6 3. An exit access shall not pass through a room that can be locked to prevent egress.

7 4. Means of egress from dwelling units or sleeping areas shall not lead through other sleeping
8 areas, toilet rooms or bathrooms.

9 5. Egress shall not pass through kitchens, storage rooms, closets or spaces used for similar
10 purposes.

11 **Exceptions:**

12 1. *Means of egress* are not prohibited through a kitchen area serving adjoining rooms
13 constituting part of the same *dwelling unit* or *sleeping unit*.

14 2. *Means of egress* are not prohibited through stockrooms in Group M occupancies
15 where all of the following are met:

16 2.1. The stock is of the same hazard classification as that found in the main retail
17 area.

18 2.2. Not more than 50 percent of the *exit access* is through the stockroom.

19 2.3. The stockroom is not subject to locking from the egress side.

20 2.4. There is a demarcated, minimum 44-inch-wide (1118 mm) *aisle* defined by
21 full- or partial-height fixed walls or similar construction that will maintain the
22 required width and lead directly from the retail area to the *exit* without
23 obstructions.

6. Unless approved by the building official, where two or more exits are required, exit travel shall not pass through an interior exit stairway as the only way to reach another exit.

Note: See Section 1010.1.9.3 for conditions in which exit access doors from elevator lobbies are permitted to be locked.

SECTION 1017

EXIT ACCESS TRAVEL DISTANCE

1017.1 General. Travel distance within the *exit access* portion of the *means of egress* system shall be in accordance with this section.

Note: Additional interior exit stairways or corridors constructed as smoke barriers may be required for standpipe hose connections. See Section 905.4.

| OCCUPANCY | WITHOUT SPRINKLER SYSTEM (feet) | WITH SPRINKLER SYSTEM (feet) |
|----------------------|--|---|
| A, E, F-1, M, R, S-1 | 200 | 250 ^b |
| I-1 | Not Permitted | 250 ^b |
| B | 200 | 300 ^c |
| F-2, S-2, U | 300 | 400 ^c |
| H-1 | Not Permitted | 75 ^d |
| H-2 | Not Permitted | 100 ^d |
| H-3 | Not Permitted | 150 ^d |
| H-4 | Not Permitted | 175 ^d |
| H-5 | Not Permitted | 200 ^c |
| I-2, I-3, I-4 | Not Permitted | 200 ^c |

For SI: 1 foot = 304.8 mm.
a. See the following sections for modifications to *exit access* travel distance requirements:
Section 402.8: For the distance limitation in malls.

Section 404.9: For the distance limitation through an atrium space.

Section 407.4: For the distance limitation in Group I-2.

Sections 408.6.1 and 408.8.1: For the distance limitations in Group I-3.

Section 411.4: For the distance limitation in special amusement buildings.

Section 412.7: For the distance limitations in aircraft manufacturing facilities.

Section 1006.2.2.2: For the distance limitation in refrigeration machinery rooms.

Section 1006.2.2.3: For the distance limitation in refrigerated rooms and spaces.

Section 1006.3.2: For buildings with one exit.

Section 1017.2.2: For increased distance limitation in Groups F-1 and S-1.

Section 1029.7: For increased limitation in assembly seating.
(~~Section 3103.4: For temporary structures.~~)

Section 3104.9: For pedestrian walkways.

b. Buildings equipped throughout with an *automatic sprinkler system* in accordance with Section 903.3.1.1 or 903.3.1.2. See Section 903 for occupancies where *automatic sprinkler systems* are permitted in accordance with Section 903.3.1.2.

c. Buildings equipped throughout with an *automatic sprinkler system* in accordance with Section 903.3.1.1.

d. Group H occupancies equipped throughout with an automatic sprinkler system in accordance with Section 903.2.5.1.

SECTION 1019

EXIT ACCESS STAIRWAYS AND RAMPS

1019.3 Occupancies other than Groups I-2 and I-3. In other than Group I-2 and I-3

occupancies, floor openings containing *exit access stairways* or *ramps* that do not comply with one of the conditions listed in this section shall be enclosed with a shaft enclosure constructed in accordance with Section 713.

1. *Exit access stairways* and *ramps* that serve or atmospherically communicate between only two stories. Such interconnected stories shall not be open to other stories.

1 7. The occupant load of Group B conference rooms, lunch rooms without grease-
 2 producing cooking and other assembly rooms with an occupant load of less than 50 in
 3 each room need not be considered when determining whether corridor construction is
 4 required, provided such rooms are accessory to an office tenant located in a building of
 5 Type IA or IB construction. This provision is permitted to be used in other
 6 construction types when the floor on which the assembly room is located is equipped
 7 with an automatic sprinkler system.

**TABLE 1020.1
 CORRIDOR FIRE-RESISTANCE RATING**

| OCCUPANCY | OCCUPANT LOAD SERVED BY CORRIDOR | REQUIRED FIRE-RESISTANCE RATING (hours) | |
|------------------------|--|--|---------------------------------------|
| | | Without sprinkler system | With sprinkler system ^c |
| H-1, H-2, H-3 | All | Not Permitted | 1 |
| H-4, H-5 | Greater than 30 | Not Permitted | 1 |
| A, B, E, F, M, S, U | Greater than 30 | 1 | 0 |
| R | ((Greater than 10)) <u>All</u> | Not Permitted | ((0.5)) <u>1</u> |
| I-2 ^a , I-4 | All | Not Permitted | 0 |
| I-1, I-3 | All | Not Permitted | 1 ^b |

a. For requirements for occupancies in Group I-2, see Sections 407.2 and 407.3.
 b. For a reduction in the *fire-resistance rating* for occupancies in Group I-3, see Section 408.8.
 c. Buildings equipped throughout with an *automatic sprinkler system* in accordance with Section 903.3.1.1 or 903.3.1.2 where allowed.

8 **1020.1.1 Hoistway opening protection.** Elevator hoistway openings shall be protected in
 9 accordance with Section 713.14.2.1.

10 ***

11 **1020.4 Dead ends.** Where more than one *exit* or *exit access doorway* is required, the *exit access*
 12 shall be arranged such that there are no dead ends in *corridors* more than ~~((20))~~ 25 feet
 13 ~~((6096))~~ 7620 mm) in length.

1 **Exceptions:**

- 2 1. In occupancies in Group I-3 of Condition 2, 3 or 4, the dead end in a *corridor* shall not
3 exceed 50 feet (15 240 mm).
- 4 2. In occupancies in Groups B, E, F, I-1, M, R-1, R-2, ~~((R-4,))~~ S and U, where the
5 building is equipped throughout with an *automatic sprinkler system* in accordance with
6 Section 903.3.1.1, the length of the dead-end *corridors* shall not exceed 50 feet (15 240
7 mm).
- 8 3. A dead-end *corridor* shall not be limited in length where the length of the dead-end
9 *corridor* is less than 2.5 times the least width of the dead-end *corridor*.
- 10 4. Dead ends are permitted to be 75 feet (22 860 mm) in length in areas containing Group
11 B offices in buildings of Types IA and IB construction, where the cumulative occupant
12 load does not exceed 50 for all areas for which the dead end serves as the only means
13 of egress.

14 **1020.5 Air movement in corridors.** *Corridors* shall not serve as supply, return, exhaust, relief or
15 ventilation air ducts or plenums except as allowed by Mechanical Code Section 601.2.

16 ~~(~~**Exceptions:**

- 17 ~~1. Use of a *corridor* as a source of makeup air for exhaust systems in rooms that open~~
18 ~~directly onto such *corridors*, including toilet rooms, bathrooms, dressing rooms,~~
19 ~~smoking lounges and janitor closets, shall be permitted, provided that each such~~
20 ~~*corridor* is directly supplied with outdoor air at a rate greater than the rate of makeup~~
21 ~~air taken from the *corridor*.~~
- 22 ~~2. Where located within a *dwelling unit*, the use of *corridors* for conveying return air~~
23 ~~shall not be prohibited.~~

1 ~~3. Where located within tenant spaces of 1,000 square feet (93 m²) or less in area,~~
2 ~~utilization of corridors for conveying return air is permitted.~~

3 ~~4. Incidental air movement from pressurized rooms within health care facilities, provided~~
4 ~~that the corridor is not the primary source of supply or return to the room.))~~

5 ***

6 **1020.6 Corridor continuity.** *Fire-resistance-rated corridors* shall be continuous from the point
7 of entry to an *exit*, and shall not be interrupted by intervening rooms. Where the path of egress
8 travel within a *fire-resistance-rated corridor* to the exit includes travel along unenclosed *exit*
9 *access stairways* or *ramps*, the *fire-resistance rating* shall be continuous for the length of the
10 *stairway* or *ramp* and for the length of the connecting *corridor* on the adjacent floor leading to
11 the *exit*.

12 **Exceptions:**

- 13 1. Foyers, lobbies or reception rooms constructed as required for *corridors* shall not be
14 construed as intervening rooms.
- 15 2. Enclosed elevator lobbies as permitted by Item 1 of Section 1016.2 shall not be
16 construed as intervening rooms.

17 **SECTION 1021**

18 **EGRESS BALCONIES**

19 ***

20 **1021.2 Wall separation.** Exterior egress balconies shall be separated from the interior of the
21 building by walls and opening protectives as required for *corridors*.

1 **1023.3.1 Extension.** Where *interior exit stairways* and *ramps* are extended to an *exit*
2 *discharge* or a *public way* by an *exit passageway*, the *interior exit stairway* and *ramp* shall be
3 separated from the *exit passageway* by a *fire barrier* constructed in accordance with Section
4 707 or a *horizontal assembly* constructed in accordance with Section 711, or both. The *fire-*
5 *resistance rating* shall be not less than that required for the *interior exit stairway* and *ramp*. A
6 *fire door* assembly complying with Section 716.5 shall be installed in the *fire barrier* to
7 provide a *means of egress* from the *interior exit stairway* and *ramp* to the *exit passageway*.
8 Openings in the *fire barrier* other than the *fire door* assembly are prohibited. Penetrations of
9 the *fire barrier* are prohibited.

10 **Exceptions:**

- 11 1. Penetrations of the *fire barrier* in accordance with Section 1023.5 shall be
12 permitted.
- 13 2. Separation between an *interior exit stairway* or *ramp* and the *exit passageway*
14 extension shall not be required where there are no openings into the *exit*
15 *passageway* extension.
- 16 3. A fire barrier and fire door assembly are not required to separate an exit
17 passageway from a pressurized stairway.

18 **1023.4 Openings.** *Interior exit stairway* and *ramp* opening protectives shall be in accordance
19 with the requirements of Section 716.

20 Openings in *interior exit stairways* and *ramps* other than unprotected exterior openings shall
21 be limited to those necessary for *exit access* to the enclosure from normally occupied spaces and
22 for egress from the enclosure.

23 Elevators shall not open into *interior exit stairways* and *ramps*.

1 **Interpretation I1023.4:** Accessory rooms such as restrooms, storage closets, laundry rooms,
2 electrical, communication closets, mechanical rooms and similar spaces shall not open
3 directly into an interior exit stairway. Rooms and spaces that are separated from the stairway
4 by a corridor or a vestibule are not considered to open directly into the interior exit stairway.
5 The corridor or vestibule shall be constructed as a minimum 1-hour fire-resistance rated fire
6 partition complying with Section 708. Openings shall comply with Sections 716.5.3 and
7 716.6.7.

8 **1023.5 Penetrations.** Penetrations into or through *interior exit stairways* and *ramps* are
9 prohibited except for the following:

- 10 1. equipment and ductwork necessary for independent ventilation or pressurization,
- 11 2. sprinkler piping,
- 12 3. standpipes,
- 13 4. electrical raceway for fire department communication systems and sprinkler monitoring
14 terminating at a steel box not exceeding 16 square inches (0.010 m²)
- 15 5. electrical raceway serving the *interior exit stairway* and *ramp* and terminating at a steel
16 box not exceeding 16 square inches (0.010 m²). Such penetrations shall be protected in
17 accordance with Section 714.
- 18 6. piping used exclusively for the drainage of rainfall runoff from roof areas, provided the
19 roof is not used for a helistop or heliport.
- 20 7. unfired unit heaters required for freeze protection of fire protection equipment are
21 permitted to penetrate one membrane; the conduit serving the heater is permitted to
22 penetrate both membranes.

1 8. equipment necessary for electrically-controlled stairway door locks and security cameras
2 are permitted to penetrate one membrane; the conduit serving the equipment is permitted
3 to penetrate both membranes.

4 There shall not be penetrations or communication openings, whether protected or not,
5 between adjacent *interior exit stairways* and *ramps*.

6 **Interpretation I1023.5:** Ducts passing through interior exit stairways shall be separated from
7 the stairway by construction having a fire-resistance rating at least equal to the stairway
8 walls. At least one side of the duct enclosure shall abut the interior exit stairway enclosure.

9 **Exception:** Membrane penetrations shall be permitted on the outside of the *interior exit*
10 *stairway* and *ramp*. Such penetrations shall be protected in accordance with Section 714.3.2.

11 ***

12 **1023.9 Stairway identification signs.** A sign shall be provided at each floor landing in an
13 *interior exit stairway* and *ramp* connecting more than three stories designating the floor level, the
14 terminus of the top and bottom of the *interior exit stairway* and *ramp* and the identification of the
15 *stairway* or *ramp*. The signage shall also state the story of, and the direction to, the *exit discharge*
16 and ~~((the availability of))~~ whether there is roof access from the *interior exit stairway* and *ramp*
17 for the fire department, and whether the roof access is accessed by roof hatch. The sign shall be
18 located 5 feet (1524 mm) above the floor landing in a position that is readily visible when the
19 doors are in the open and closed positions. In addition to the *stairway* identification sign, a floor-
20 level sign in visual characters, raised characters and braille complying with *ICC A117.1* shall be
21 located at each floor-level landing adjacent to the door leading from the *interior exit stairway*
22 and *ramp* into the *corridor* to identify the floor level.

23 ***

1 **1023.11 Pressurized stairways ((Smokeproof enclosures)).** Where required by Section 403.5.4,
2 ((~~or~~) 405.7.2 or 510.2, *interior exit stairways* and *ramps* shall be ((*smokeproof enclosures*))
3 pressurized in accordance with Section 909.20.5 or 909.20.6.

4 **1023.11.1 Termination and extension.** A ((*smokeproof enclosure*)) pressurized stairway
5 shall terminate at an exit discharge or a public way. The ((*smokeproof enclosure*))
6 pressurized stairway shall be permitted to be extended by an exit passageway in accordance
7 with Section 1023.3. ((~~The exit passageway shall be without openings other than the fire door~~
8 ~~assembly required by Section 1023.3.1 and those necessary for egress from the exit~~
9 ~~passageway.~~) The exit passageway shall be separated from the remainder of the building by
10 2-hour fire barriers constructed in accordance with Section 707 or horizontal assemblies
11 constructed in accordance with Section 711, or both. The exit passageway shall be protected
12 and pressurized in the same manner as the pressurized stairway.

13 **Exception((s)):**

- 14 ((1. Openings in the *exit passageway* serving a *smokeproof enclosure* are permitted
15 where the *exit passageway* is protected and pressurized in the same manner as the
16 *smokeproof enclosure*, and openings are protected as required for access from other
17 floors.
18 2. The *fire barrier* separating the *smokeproof enclosure* from the *exit passageway* is
19 not required, provided the *exit passageway* is protected and pressurized in the same
20 manner as the *smokeproof enclosure*.
21 3.)) A ((*smokeproof enclosure*)) pressurized stairway shall be permitted to egress
22 through areas on the *level of exit discharge* or vestibules as permitted by Section
23 1028.

1 ~~((1023.11.2 Enclosure access. Access to the stairway or ramp within a smokeproof enclosure~~
2 ~~shall be by way of a vestibule or an open exterior balcony.~~

3 ~~**Exception:** Access is not required by way of a vestibule or exterior balcony for stairways~~
4 ~~and ramps using the pressurization alternative complying with Section 909.20.5.))~~

5 **1023.12 Equipment in interior exit stairways.** Equipment is prohibited in interior exit
6 stairways except for equipment necessary for independent pressurization, lighting of the interior
7 exit stairway, sprinkler piping, standpipes, electrical equipment for fire department
8 communication and sprinkler monitoring, and unit heaters required to protect fire protection
9 equipment from freezing.

10 SECTION 1024

11 EXIT PASSAGEWAYS

12 ***

13 **1024.5 Openings.** *Exit passageway* opening protectives shall be in accordance with the
14 requirements of Section 716.

15 ~~((Except as permitted in Section 402.8.7, openings in *exit passageways* other than~~
16 ~~unprotected exterior openings shall be limited to those necessary for *exit access* to the *exit*~~
17 ~~*passageway* from normally occupied spaces and for egress from the *exit passageway*.)~~

18 The following openings are permitted in exit passageways:

- 19 1. Doors from rooms and spaces in accordance with Section 402.8.7;
- 20 2. Unprotected exterior openings;
- 21 3. Doors necessary for exit access from normally occupied spaces;
- 22 4. Doors necessary for egress from the exit passageway;
- 23 5. Doors from interior exit stairways.

1 Where an *interior exit stairway* or *ramp* is extended to an *exit discharge* or a *public way*
2 by an *exit passageway*, the *exit passageway* shall comply with Section 1023.3.1.

3 Elevators shall not open into an *exit passageway*.

Interpretation I1024.5: Accessory rooms such as restrooms, storage closets, laundry rooms, electrical, communication closets, mechanical rooms and similar spaces shall not open directly into an exit passageway. Rooms and spaces that are separated from the exit passageway by a corridor or a vestibule are not considered to open directly into the exit passageway. The corridor or vestibule shall be constructed as a minimum 1-hour fire-resistance rated fire partition complying with Section 708. Openings shall comply with Sections 716.5.3 and 716.6.7.

4
5 **Code Alternate CA1024.5:** An elevator is permitted to open into an exit passageway when the
6 following conditions are met:

7 1. A lobby shall separate the elevator from the exit passageway. This is allowed at only one
8 location in the building. The lobby is required whether the elevator hoistway is pressurized or
9 not.

10 2. The separation shall be constructed as a fire barrier having a fire-resistive rating and opening
11 protectives as for the exit passageway. The door between the lobby and the exit passageway
12 shall also comply with Section 716.5.3. The door shall have listed gaskets installed at head,
13 jams and meeting edges. This only applies to the walls common with the exit passageway.

14 3. The lobby shall have a minimum depth of 36 inches. (Note that areas of refuge may require a
15 larger dimension).

1 4. An elevator lobby constructed as a smoke partition shall be provided at every floor below the
2 level of the exit passageway served by the elevator. Hoistway pressurization is permitted to be
3 used in lieu of the lobbies on floors below the level of the exit passageway.

4 5. A door as required by Section 1023.3.1 between an interior exit stairway and the exit
5 passageway shall be provided.

6 6. An automatic sprinkler system in accordance with Section 903.3.1.1 shall be provided
7 throughout the floor on which the exit passageway is located.

8 This alternate does not apply to interior exit stairways.

9 **1024.6 Penetrations.** Penetrations into or through an *exit passageway* are prohibited except for
10 equipment and ductwork necessary for independent pressurization, sprinkler piping, standpipes,
11 electrical raceway for fire department communication and electrical raceway serving the *exit*
12 *passageway* and terminating at a steel box not exceeding 16 square inches (0.010 m²). Such
13 penetrations shall be protected in accordance with Section 714. There shall not be penetrations or
14 communicating openings, whether protected or not, between adjacent *exit passageways*.

15 **Exceptions:**

16 1. Membrane penetrations shall be permitted on the outside of the *exit passageway*. Such
17 penetrations shall be protected in accordance with Section 714.3.2.

18 2. Unfired unit heaters allowed by Section 1023.12 to be installed in interior exit stairways
19 are permitted to penetrate one membrane. The conduit serving the heater is permitted to
20 penetrate both membranes.

21 ***

22 **SECTION 1025**

23 **LUMINOUS EGRESS PATH MARKINGS**

1 ***

2 **1025.2.6 Doors within the exit path.** Doors through which occupants must pass in order to
3 complete the exit path shall be provided with markings complying with Sections 1025.2.6.1
4 through 1025.2.6.3.

5 **Exception:** Main exterior exit doors or gates that are obviously and clearly identifiable
6 as exits need not be provided with markings where approved by the building official.

7 ***

8 SECTION 1027

9 EXTERIOR EXIT STAIRWAYS AND RAMPS

10 ***

11 **1027.3 Open side.** *Exterior exit stairways and ramps* serving as an element of a required *means*
12 *of egress* shall be at least 50 percent open on not less than one side~~((, except for required~~
13 ~~structural columns, beams, handrails and guards))~~. An open side shall have not less than ~~((35~~
14 ~~square feet (3.3 m²))~~) 28 square feet (2.6 m²) of aggregate open area adjacent to each floor level,
15 ~~((and the level of each intermediate landing. The required open area shall be located not less than~~
16 ~~42 inches (1067 mm) above the adjacent floor or landing level.))~~ The open area shall be
17 distributed to prevent accumulation of smoke or toxic gases.

18 ***

19 **1027.6 Exterior exit stairway and ramp protection.** *Exterior exit stairways and ramps* shall be
20 separated from the interior of the building as required in Section 1023.2. Openings shall be
21 limited to those necessary for egress from normally occupied spaces. Where a vertical plane
22 projecting from the edge of an *exterior exit stairway or ramp* and landings is exposed by other

1 parts of the building at an angle of less than 180 degrees (3.14 rad), the exterior wall shall be
2 rated in accordance with Section 1023.7.

3 **Exceptions:**

- 4 1. Separation from the interior of the building is not required for occupancies, other than
5 those in Group R-1 or R-2, in buildings that are not more than two stories above *grade*
6 *plane* where a *level of exit discharge* serving such occupancies is the first story above
7 *grade plane*.
- 8 2. Separation from the interior of the building is not required where the *exterior exit*
9 *stairway* or *ramp* is served by an *exterior exit ramp* or balcony that connects two
10 remote *exterior exit stairways* or other *approved exits* with a perimeter that is not less
11 than 50 percent open. To be considered open, the opening shall be not less than 50
12 percent of the height of the enclosing wall, with the top of the openings not less than 7
13 feet (2134 mm) above the top of the balcony.
- 14 3. Separation from the open-ended *corridor* of the building is not required for *exterior*
15 *exit stairways* or *ramps*, provided that Items 3.1 through 3.5 are met:
- 16 3.1. The building, including open-ended *corridors*, and *stairways* and *ramps*, shall be
17 equipped throughout with an *automatic sprinkler system* in accordance with
18 Section 903.3.1.1 or 903.3.1.2.
- 19 3.2. The open-ended *corridors* comply with Section 1020.
- 20 3.3. The open-ended *corridors* are connected on each end to an *exterior exit stairway*
21 or *ramp* complying with Section 1027.
- 22 3.4. The *exterior walls* and openings adjacent to the *exterior exit stairway* or *ramp*
23 comply with Section 1023.7 and 1027.7.

1 3.5. At any location in an open-ended *corridor* where a change of direction exceeding
2 45 degrees (0.79 rad) occurs, a clear opening of not less than 35 square feet (3.3
3 m2) or an *exterior stairway* or *ramp* shall be provided. Where clear openings are
4 provided, they shall be located so as to minimize the accumulation of smoke or
5 toxic gases.

6 **1027.7 Exterior exit stairway and ramp exterior walls.** Where nonrated walls or unprotected
7 openings enclose the exterior of the stairway and the walls or openings are exposed by other
8 parts of the building at an angle of less than 180 degrees (3.14 rad), the building exterior walls
9 within 10 feet (3048 mm) horizontally of a nonrated wall or unprotected opening shall have a
10 fire-resistance rating of not less than 1 hour. Openings within such exterior walls shall be
11 protected by opening protectives having a fire protection rating of not less than 3/4 hour. This
12 construction shall extend vertically from the ground to a point 10 feet (3048 mm) above the
13 topmost landing of the stairway or to the roof line, whichever is lower.

14 **SECTION 1028**

15 **EXIT DISCHARGE**

16 **1028.1 General.** *Exits* shall discharge directly to the exterior of the building. The *exit discharge*
17 shall be at grade or shall provide a direct path of egress travel to grade. The *exit discharge* shall
18 not reenter a building except into an exit or as otherwise approved by the building official. The
19 combined use of Exceptions 1 and 2 shall not exceed 50 percent of the number and minimum
20 width or required capacity of the required exits.

1 **Exceptions:**

2 1. Not more than 50 percent of the number and minimum width or required capacity of
3 *interior exit stairways* and *ramps* is permitted to egress through areas on the level of
4 discharge provided all of the following conditions are met:

5 1.1. Discharge of *interior exit stairways* and *ramps* shall be provided with a free and
6 unobstructed path of travel to an exterior *exit* door and such *exit* is readily visible
7 and identifiable from the point of termination of the enclosure.

8 1.2. The entire area of the *level of exit discharge* is separated from areas below by
9 construction conforming to the *fire-resistance rating* for the enclosure.

10 1.3. The egress path from the *interior exit stairway* and *ramp* on the *level of exit*
11 *discharge* is protected throughout by an *approved automatic sprinkler system*.
12 Portions of the *level of exit discharge* with access to the egress path shall be either
13 equipped throughout with an *automatic sprinkler system* installed in accordance
14 with Section 903.3.1.1 or 903.3.1.2, or separated from the egress path in
15 accordance with the requirements for the enclosure of *interior exit stairways* or
16 *ramps*.

17 1.4. Where a required *interior exit stairway* or *ramp* and an *exit access stairway* or
18 *ramp* serve the same floor level and terminate at the same *level of exit discharge*,
19 the termination of the *exit access stairway* or *ramp* and the *exit discharge* door of
20 the *interior exit stairway* or *ramp* shall be separated by a distance of not less than
21 30 feet (9144 mm) or not less than one-fourth the length of the maximum overall
22 diagonal dimension of the building, whichever is less. The distance shall be
23 measured in a straight line between the *exit discharge* door from the *interior exit*

1 *stairway* or *ramp* and the last tread of the *exit access stairway* or termination of
2 slope of the *exit access ramp*.

3 2. Not more than 50 percent of the number and minimum width or required capacity of
4 the *interior exit stairways* and *ramps* is permitted to egress through a vestibule
5 provided all of the following conditions are met:

6 2.1. The entire area of the vestibule is separated from areas below by construction
7 conforming to the fire-resistance rating of the interior exit stairway or ramp
8 enclosure.

9 2.2. The depth from the exterior of the building is not greater than 10 feet (3048 mm)
10 and the ((length)) width is not greater than 30 feet (9144 mm).

11 2.3. The area is separated from the remainder of the *level of exit discharge* by a *fire*
12 *partition* constructed in accordance with Section 708.

13 **Exception:** The maximum transmitted temperature rise is not required.

14 2.4. The area is used only for *means of egress* and *exits* directly to the outside.

15 **Interpretation I1028.1:** Exception 2 applies only to vestibules with *direct access*
16 from the interior exit stairway or ramp.

17 3. Horizontal exits complying with Section 1026 shall not be required to discharge
18 directly to the exterior of the building.

19 **1028.1.1 Remoteness of egress paths at building exterior.** The paths of egress travel from
20 separate exits shall be separated by at least 10 feet at the exterior of the building. Where 3 or
21 more exits are required, at least 2 paths shall be arranged in accordance with this provision.

22 ***

1 **1028.4 Egress courts.** *Egress courts* serving as a portion of the *exit discharge* in the *means of*
2 *egress* system shall comply with the requirements of Sections 1028.4.1 and 1028.4.2.

3 **1028.4.1 Width or capacity.** The required capacity of *egress courts* shall be determined as
4 specified in Section 1005.1, but the minimum width shall be not less than 44 inches (1118
5 mm), except as specified herein. *Egress courts* serving Group R-3 and U occupancies shall
6 be not less than 36 inches (914 mm) in width. The required capacity and width of *egress*
7 *courts* shall be unobstructed to a height of 7 feet (2134 mm).

8 **Exception:** Encroachments complying with Section 1005.7.

9 ~~((Where an *egress court* exceeds the minimum required width and the width of such~~
10 ~~*egress court* is then reduced along the path of exit travel, the reduction in width shall be~~
11 ~~gradual. The transition in width shall be affected by a guard not less than 36 inches (914 mm)~~
12 ~~in height and shall not create an angle of more than 30 degrees (0.52 rad) with respect to the~~
13 ~~axis of the *egress court* along the path of egress travel. The width of the *egress court* shall not~~
14 ~~be less than the required capacity.))~~

15 **1028.4.2 Construction and openings.** Where an *egress court* serving a building or portion
16 thereof is less than 10 feet (3048 mm) in width, the *egress court* walls shall have not less than
17 1-hour *fire-resistance-rated* construction for a distance of 10 feet (3048 mm) above the floor
18 of the *egress court*. Openings within such walls shall be protected by opening protectives
19 having a fire protection rating of not less than 3/4 hour.

20 **Exceptions:**

- 21 1. *Egress courts* serving an *occupant load* of less than 10.
22 2. *Egress courts* serving Group R-3.

1 3. In buildings other than those which have a single means of egress under Section
2 1006.3.2 item 7, opening protection need not be provided where it is possible to
3 exit in two directions from the court.

4 ***

5 SECTION 1030

6 EMERGENCY ESCAPE AND RESCUE

7 **1030.1 General.** In addition to the *means of egress* required by this chapter, ~~((provisions shall be~~
8 ~~made for))~~ *emergency escape and rescue openings shall be provided in:*

- 9 1. Group R-2 occupancies in accordance with Tables 1006.3.2(1) and 1006.3.2(2);
10 2. Buildings designed with a single exit according to Section 1006.3.2, exception 7; and
11 3. Group R-3 occupancies.

12 **1030.1.1 Where required.** Where required by Section 1030.1, ~~((B))~~*basements* and sleeping
13 rooms below the fourth story above *grade plane* shall have at least one exterior *emergency*
14 *escape and rescue opening* in accordance with this section. Where *basements* contain one or
15 more sleeping rooms, *emergency escape and rescue openings* shall be required in each
16 sleeping room, but shall not be required in adjoining areas of the *basement*. Such openings
17 shall open directly into a *public way* or to a *yard* or *court* that opens to a *public way*.

18 **Exceptions:**

- 19 1. *Basements* with a ceiling height of less than 80 inches (2032 mm) shall not be
20 required to have *emergency escape and rescue openings*.
21 2. *Emergency escape and rescue openings* are not required from *basements* or
22 sleeping rooms that have an *exit* door or *exit access* door that opens directly into a
23 *public way* or to a *yard*, *court* or exterior exit balcony that opens to a *public way*.

1 3. *Basements* without *habitable spaces* and having not more than 200 square feet
2 (18.6 m²) in floor area shall not be required to have *emergency escape and rescue*
3 *openings*.

4 ***

5 Section 11. The following sections of Chapter 11 of the International Building Code,
6 2015 Edition, are amended as follows:

7 **CHAPTER 11**

8 **ACCESSIBILITY**

9 Note: The City of Seattle does not have authority to enforce or interpret the Americans with
10 Disabilities Act (ADA), ADA Accessibility Guidelines (ADAAG), Fair Housing Act and other
11 state and federal accessibility laws. Approval of a building by SDCI cannot guarantee
12 compliance with those regulations.

13 **SECTION 1101**

14 **GENERAL**

15 ***

16 **[W]1101.2 Design.** Buildings and facilities shall be designed and constructed to be *accessible* in
17 accordance with this code and ICC A117.1, except those portions of ICC A117.1 amended by
18 this section.

19 **1101.2.1 (ICC A117.1 Section 403.5) Clear width of accessible route.** Clear width of an
20 accessible route shall comply with ICC A117.1 Section 403.5. For exterior routes of travel, the
21 minimum clear width is 44 inches (1118 mm).

1 **1101.2.2 (ICC A117.1 Section 404.2.8) Door-opening force.** Fire doors shall have the
2 minimum opening force allowed by the building official. The force for pushing or pulling open
3 doors other than fire doors shall be as follows:

- 4 1. Interior hinged door: 5.0 pounds (22.2 N) maximum.
- 5 2. Interior sliding or folding doors: 5.0 pounds (22.2 N) maximum.
- 6 3. Exterior hinged, sliding or folding door: 10 pounds (44.5 N) maximum.

7 **Exception:** Interior or exterior automatic doors complying with ICC A117.1 Section 404.
8 These forces do not apply to the force required to retract latch bolts or disengage other
9 devices that hold the door in a closed position.

10 **1101.2.3 (ICC A117.1 Section 407.4.6.2.2) Arrangement of elevator car buttons.** Elevator
11 car buttons shall be arranged with numbers in ascending order. When two or more columns of
12 buttons are provided they shall read from left to right.

13 **1101.2.4 (ICC A117.1 606.7) Operable parts.** Operable parts on drying equipment, towel or
14 cleansing product dispensers, and disposal fixtures shall comply with ICC A117.1 Table 603.6.

15 **1101.2.5 (ICC A117.1 Section 604.6) Flush controls.** Flush controls shall be hand operated or
16 automatic. Hand operated flush controls shall comply with ICC A117.1 Section 309, except the
17 maximum height above the floor shall be 44 inches (1118 mm). Flush controls shall be located
18 on the open side of the water closet.

19 **Exception:** In ambulatory accessible compartments complying with ICC A117.1 Section
20 604.10, flush controls are permitted to be located on either side of the water closet.

21 **1101.2.6 (ICC A117.1 Section 703.6.3.1) International Symbol of Accessibility.** Where the
22 International Symbol of Accessibility is required, it shall be proportioned complying with ICC

1 A117.1 Figure 703.6.3.1. All interior and exterior signs depicting the International Symbol of
2 Accessibility shall be white on a blue background.

3 **SECTION 1102**

4 **DEFINITIONS**

5 **1102.1 Definitions.** The following terms are defined in Chapter 2:

6 ***

7 **CLOSED-CIRCUIT TELEPHONE.**

8 ***

9 **MAILBOXES.**

10 ***

11 **TRANSIENT LODGING.**

12 ***

13 **SECTION 1104**

14 **ACCESSIBLE ROUTE**

15 ***

16 **[W] 1104.7 Raised platforms.** In banquet rooms or spaces where a head table or speaker's
17 lectern is located on a raised platform, an *accessible* route shall be provided to the platform.

18 ***

19 **SECTION 1106**

20 **PARKING AND PASSENGER LOADING FACILITIES**

21 ***

1 **[W] 1106.2 Groups I-1, R-1, R-2, and R-3 ((and R-4)).** *Accessible* parking spaces shall be
2 provided in Group I-1, R-1, R-2, and R-3 ((and R-4)) occupancies in accordance with Items 1
3 through 4 as applicable.

4 1. In Group R-2, and R-3 ((and R-4)) occupancies that are required to have *Accessible, Type A*
5 *or Type B dwelling units or sleeping units*, at least 2 percent, but not less than one, of each
6 type of parking space provided shall be *accessible*.

7 2. In Group I-1 and R-1 occupancies, *accessible* parking shall be provided in accordance with
8 Table 1106.1.

9 3. Where at least one parking space is provided for each *dwelling unit or sleeping unit*, at least
10 one *accessible* parking space shall be provided for each *Accessible* and *Type A unit*.

11 4. Where parking is provided within or beneath a building, *accessible* parking spaces shall
12 also be provided within or beneath the building.

13 ***

14 **[W] 1106.6 Location.** *Accessible* parking spaces shall be located on the shortest *accessible route*
15 of travel from adjacent parking to an *accessible* building entrance. In parking facilities that do
16 not serve a particular building, *accessible* parking spaces shall be located on the shortest route to
17 an *accessible* pedestrian entrance to the parking facility. Where buildings have multiple
18 *accessible* entrances with adjacent parking, *accessible* parking spaces shall be dispersed and
19 located near the *accessible* entrances. Wherever practical, the accessible route shall not cross
20 lanes of vehicular traffic. Where crossing traffic lanes is necessary, the route shall be designated
21 and marked as a crosswalk.

1 **Exceptions:**

- 2 1. In multilevel parking structures, van-accessible parking spaces are permitted on one
3 level.
- 4 2. Accessible parking spaces shall be permitted to be located in different parking
5 facilities if substantially equivalent or greater accessibility is provided in terms of
6 distance from an accessible entrance or entrances, parking fee and user
7 convenience.

8 ***

9 **SECTION 1107**

10 **DWELLING UNITS, ~~((AND))~~ SLEEPING UNITS AND TRANSIENT LODGING**

11 **FACILITIES**

12 ***

13 **1107.4 Accessible route.** At least one *accessible route* shall connect *accessible* building or facility
14 entrances with the primary entrance of each *Accessible unit*, *Type A unit* and *Type B unit* within
15 the building or facility and with those exterior and interior spaces and facilities that serve the units.

16 **Exceptions:**

- 17 1. If due to circumstances outside the control of the owner, either the slope of the finished
18 ground level between accessible facilities and buildings exceeds one unit vertical in 12
19 units horizontal (1:12), or where physical barriers or legal restrictions prevent the
20 installation of an accessible route, a vehicular route with parking that complies with
21 Section 1106 at each public or common use facility or building is permitted in place of the
22 accessible route.

1 2. In Group I-3 facilities, an accessible route is not required to connect stories or mezzanines
2 where Accessible units, all common use areas serving Accessible units and all public use
3 areas are on an accessible route.

4 3. In Group R-2 facilities with *Type A units* complying with Section 1107.6.2.2.1, an
5 *accessible route* is not required to connect *stories* or *mezzanines* where *Type A units*, all
6 *common use* areas serving *Type A units* and all public use areas are on an *accessible route*.

7 4. In other than Group R-2 dormitory housing provided by places of education, in Group R-2
8 facilities with *Accessible units* complying with Section 1107.6.2.3.1, an *accessible route* is
9 not required to connect *stories* or *mezzanines* where *Accessible units*, all *common use* areas
10 serving *Accessible units* and all *public use* areas are on an *accessible route*.

11 5. In Group R-1, an *accessible route* is not required to connect *stories* or *mezzanines* within
12 individual units, provided the *accessible* level meets the provisions for *Accessible units*
13 and sleeping accommodations for two persons minimum and a toilet facility are provided
14 on that level.

15 6. In congregate residences in Groups R-3 (~~and R-4~~), an *accessible route* is not required to
16 connect *stories* or *mezzanines* where *Accessible units* or *Type B units*, all *common use*
17 areas serving *Accessible units* and *Type B units* and all *public use* areas serving *Accessible*
18 *units* and *Type B units* are on an *accessible route*.

19 7. An *accessible route* between stories is not required where *Type B units* are exempted by
20 Section 1107.7.

21 ***

22 **[W]1107.6 Group R.** *Accessible units, Type A units and Type B units* shall be provided in
23 Group R occupancies in accordance with Sections 1107.6.1 through 1107.6.4. Accessible

1 and Type A units shall be apportioned among efficiency dwelling units, single bedroom units
2 and multiple bedroom units, in proportion to the numbers of such units in the building.

3 ***

4 **[W] 1107.6.2.2.1 Type A units.** In Group R-2 occupancies containing more than ~~((20))~~ 10
5 *dwelling units* or *sleeping units*, at least ~~((2))~~ 5 percent but not less than one of the units
6 shall be a *Type A unit*. All ~~((Group R-2))~~ units on a *site* shall be considered to determine the
7 total number of units and the required number of *Type A units*. *Type A units* shall be
8 dispersed among the various classes of units, as described in Section 1107.6. Bedrooms in
9 monasteries and convents shall be counted as *sleeping units* for the purpose of determining
10 the number of units. Where the *sleeping units* are grouped into suites, only one *sleeping*
11 *unit* in each suite shall count towards the number of required *Type A units*.

12 **Exceptions:**

- 13 1. The number of *Type A units* is permitted to be reduced in accordance with Section
14 1107.7.
- 15 2. *Existing structures* on a *site* shall not contribute to the total number of units on a
16 *site*.

17 ***

18 **[W] 1107.6.2.3 Group R-2 other than live/work units, apartment houses, monasteries**
19 **and convents.** In Group R-2 occupancies, other than *live/work units*, apartment houses,
20 monasteries and convents falling within the scope of Sections 1107.6.2.1 and 1107.6.2.2,
21 *Accessible units* and *Type B units* shall be provided in accordance with Sections 1107.6.2.3.1
22 and 1107.6.2.3.2. Bedrooms within congregate living facilities shall be counted as *sleeping*
23 *units* for the purpose of determining the number of units. Where the *sleeping units* are

1 grouped into suites, only one *sleeping unit* in each suite shall be permitted to count towards
2 the number of required *Accessible units*. Accessible units shall be dispersed among the
3 various classes of units, as described in Section 1107.6.

4 ***

5 ~~[W] ((1107.6.4 Group R-4. Accessible units and Type B units shall be provided in Group R-4~~
6 ~~occupancies in accordance with Sections 1107.6.4.1 and 1107.6.4.2. Bedrooms in Group R-4~~
7 ~~facilities shall be counted as sleeping units for the purpose of determining the number of units.~~

8 ~~1107.6.4.1 Accessible units. In Group R-4 Condition 1, at least one of the sleeping units~~
9 ~~shall be an Accessible unit. In Group R-4 Condition 2, at least two of the sleeping units shall~~
10 ~~be an Accessible unit.~~

11 ~~1107.6.4.2 Type B units. In structures with four or more sleeping units intended to be~~
12 ~~occupied as a residence, every sleeping unit intended to be occupied as a residence shall be a~~
13 ~~Type B unit.~~

14 ~~Exception: The number of Type B units is permitted to be reduced in accordance with~~
15 ~~Section 1107.7.)~~

16 ***

17 [W] 1107.8 Communication features. Accessible communication features shall be provided
18 in accordance with Sections 1107.8.1 through 1107.8.4.

19 1107.8.1 Transient lodging. In transient lodging facilities, sleeping units with accessible
20 communication features shall be provided in accordance with Table 1107.8. Units required
21 to comply with Table 1107.8 shall be dispersed among the various classes of units.

[W] TABLE 1107.8

| DWELLING OR SLEEPING UNITS WITH ACCESSIBLE COMMUNICATION FEATURES | |
|--|--|
| <u>TOTAL NUMBER OF DWELLING OR SLEEPING UNITS PROVIDED</u> | <u>MINIMUM REQUIRED NUMBER OF DWELLING OR SLEEPING UNITS WITH ACCESSIBLE COMMUNICATION FEATURES</u> |
| <u>1</u> | <u>1</u> |
| <u>2 to 25</u> | <u>2</u> |
| <u>26 to 50</u> | <u>4</u> |
| <u>51 to 75</u> | <u>7</u> |
| <u>76 to 100</u> | <u>9</u> |
| <u>101 to 150</u> | <u>12</u> |
| <u>151 to 200</u> | <u>14</u> |
| <u>201 to 300</u> | <u>17</u> |
| <u>301 to 400</u> | <u>20</u> |
| <u>401 to 500</u> | <u>22</u> |
| <u>501 to 1,000</u> | <u>5% of total</u> |
| <u>1,001 and over</u> | <u>50 plus 3 for each 100 over 1,000</u> |

1 **1107.8.2 Group I-3.** In Group I-3 occupancies at least 2 percent, but no fewer than one of the
 2 total number of general holding cells and general housing cells equipped with audible
 3 emergency alarm systems and permanently installed telephones within the cell, shall comply
 4 with Section 1107.8.4.

5 **1107.8.3 Dwelling units and sleeping units.** Where *dwelling units* and *sleeping units* are
 6 altered or added, the requirements of Section 1107.8 shall apply only to the units being
 7 altered or added until the number of units with accessible communication features complies
 8 with the minimum number required for new construction.

9 **1107.8.4 Notification devices.** Visual notification devices shall be provided to alert room
 10 occupants of incoming telephone calls and a door knock or bell. Notification devices shall
 11 not be connected to visual alarm signal appliances. Permanently installed telephones shall
 12 have volume controls and an electrical outlet complying with ICC 117.1 located within 48
 13 inches (1219 mm) of the telephone to facilitate the use of a TTY.

14 ***

15 **SECTION 1109**

OTHER FEATURES AND FACILITIES

[W] 1109.2.4 Portable toilets and bathing rooms. Where multiple single-user portable toilet or bathing units are clustered at a single location, at least 5 percent, but not less than one toilet unit or bathing unit at each cluster, shall be accessible. Signs containing the International Symbol of Accessibility shall identify *accessible* portable toilets and bathing units.

Exception: Portable toilet units provided for use exclusively by construction personnel on a construction site.

[W] 1109.16 Laundry equipment. Where provided in spaces required to be *accessible*, washing machines and clothes dryers shall comply with this section.

1109.16.1 Washing machines. Where three or fewer washing machines are provided, at least one shall be accessible. Where more than three washing machines are provided, at least two shall be accessible.

1109.16.2 Clothes dryers. Where three or fewer clothes dryers are provided, at least one shall be accessible. Where more than three clothes dryers are provided, at least two shall be accessible.

[W] 1109.17 Gaming machines, depositories, vending machines, change machines and similar equipment. At least one of each type of depository, vending machine, change machine and similar equipment shall be accessible. Two percent of gaming machines shall be accessible and provided with a front approach. Accessible gaming machines shall be distributed throughout the different types of gaming machines provided.

Exception: Drive-up-only depositories are not required to comply with this section.

1 **[W] 1109.18 Mailboxes.** Where mailboxes are provided in an interior location, at least 5 percent,
2 but not less than one, of each type shall be accessible. In residential and institutional facilities,
3 where mailboxes are provided for each *dwelling unit* or *sleeping unit*, accessible mailboxes shall
4 be provided for each unit required to be an *accessible unit*.

5 **[W] 1109.19 Automatic teller machines and fare machines.** Where automatic teller machines
6 or self-service fare vending, collection or adjustment machines are provided, at least one
7 machine of each type at each location where such machines are provided shall be *accessible*.
8 Where bins are provided for envelopes, wastepaper or other purposes, at least one of each type
9 shall be accessible.

10 **[W] 1109.20 Two-way communication systems.** Where two-way communication systems are
11 provided to gain admittance to a building or facility or to restricted areas within a building or
12 facility, the system shall be accessible.

SECTION 1110

RECREATIONAL FACILITIES

16 **[W] 1110.2 Facilities serving Group R-2, and R-3 ((and R-4)) occupancies.** Recreational
17 facilities that serve Group R-2, and R-3 ((and Group R-4)) occupancies shall comply with
18 Sections 1110.2.1 through 1110.2.3, as applicable.

19 **1110.2.1 Facilities serving Accessible units.** In Group R-2 ((and R-4)) occupancies where
20 recreational facilities serve *Accessible units*, every recreational facility of each type serving
21 *Accessible units* shall be *accessible*.

22 **1110.2.2 Facilities serving Type A and Type B units in a single building.** In Group R-2((;))
23 and R-3 ((and R-4)) occupancies where recreational facilities serve a single building containing

1 Type A units or Type B units, 25 percent, but not less than one, of each type of recreational
2 facility shall be accessible. Every recreational facility of each type on a site shall be considered
3 to determine the total number of each type that is required to be accessible.

4 **1110.2.3 Facilities serving Type A and Type B units in multiple buildings.** In Group R-2(~~(5)~~)
5 and R-3 (~~and R-4~~) occupancies on a single site where multiple buildings containing *Type A*
6 *units* or *Type B units* are served by recreational facilities, 25 percent, but not less than one, of
7 each type of recreational facility serving each building shall be *accessible*. The total number of
8 each type of recreational facility that is required to be *accessible* shall be determined by
9 considering every recreational facility of each type serving each building on the site.

10 ***

11 SECTION 1111

12 SIGNAGE

13 **1111.1 Signs.** Required *accessible* elements shall be identified by the International Symbol of
14 Accessibility at the following locations.

- 15 1. *Accessible* parking spaces required by Section 1106.1.

16 **Exception:** Where the total number of parking spaces provided is four or less, identification
17 of accessible parking spaces is not required.

- 18 2. Accessible parking spaces required by Section 1106.2.

19 **Exception:** In Group I-1, R-2, and R-3 (~~and R-4~~) facilities, where parking spaces are
20 assigned to specific dwelling units or sleeping units, identification of accessible parking
21 spaces is not required.

- 22 3. Accessible passenger loading zones.

- 1 4. Accessible rooms where multiple single-user toilet or bathing rooms are clustered at a single
- 2 location.
- 3 5. Accessible entrances where not all entrances are accessible.
- 4 6. Accessible check-out aisles where not all aisles are accessible. The sign, where provided,
- 5 shall be above the check-out aisle in the same location as the check-out aisle number or type
- 6 of check-out identification.
- 7 7. Family or assisted-use toilet and bathing rooms.
- 8 8. Accessible dressing, fitting and locker rooms where not all such rooms are accessible.
- 9 9. Accessible areas of refuge in accordance with Section 1009.9.
- 10 10. Exterior areas for assisted rescue in accordance with Section 1009.9.
- 11 11. In recreational facilities, lockers that are required to be accessible in accordance with Section
- 12 1109.9.

13 ***

14 **[W] 1111.3 Other signs.** Signage indicating special accessibility provisions shall be provided as
15 shown.

- 16 1. Each assembly area required to comply with Section 1108.2.7 shall provide a sign notifying
- 17 patrons of the availability of assistive listening systems. The sign shall comply with ICC
- 18 A117.1 requirements for visual characters and include the International Symbol of Access
- 19 for Hearing Loss.

20 **Exception:** Where ticket offices or windows are provided, signs are not required at each
21 assembly area provided that signs are displayed at each ticket office or window informing
22 patrons of the availability of assistive listening systems.

2. At each door to an area of refuge, an exterior area for assisted rescue, an egress stairway, exit passageway and exit discharge, signage shall be provided in accordance with Section 1013.4.
3. At areas of refuge, signage shall be provided in accordance with Section 1009.11.
4. At exterior areas for assisted rescue, signage shall be provided in accordance with Section 1009.11.
5. At two-way communication systems, signage shall be provided in accordance with Section 1009.8.2.
6. In interior exit stairways and ramps, floor level signage shall be provided in accordance with Section 1023.9.
7. Signs identifying the type of access provided on amusement rides required to be accessible by Section 1110.4.8 shall be provided at entries to queues and waiting lines. In addition, where accessible unload areas also serve as accessible load areas, signs indicating the location of the accessible load and unload areas shall be provided at entries to queues and waiting lines. These directional sign characters shall meet the visual character requirements in accordance with ICC A117.1.
8. At bus stops and terminals, signage shall be provided in accordance with Section 1113.4.
9. At fixed facilities and stations, signage shall be provided in accordance with Sections 1114.2.2 through 1114.2.2.3.
10. At airports, terminal information systems shall be provided in accordance with Section 1115.3.

1 **[W] 1111.5 Designations.** Interior and exterior signs identifying permanent rooms and spaces
2 shall be visual characters, raised characters and braille complying with ICC A117.1. Where
3 pictograms are provided as designations of interior rooms and spaces, the pictograms shall have
4 visual characters, raised characters and braille complying with ICC A117.1.

5 **Exceptions:**

- 6 1. Exterior signs that are not located at the door to the space they serve are not required to
7 comply.
- 8 2. Building directories, menus, seat and row designations in assembly areas, occupant
9 names, building addresses and company names and logos are not required to comply.
- 10 3. Signs in parking facilities are not required to comply.
- 11 4. Temporary (seven days or less) signs are not required to comply.
- 12 5. In detention and correctional facilities, signs not located in public areas are not required
13 to comply.

14 **[W] 1111.6 Directional and informational signs.** Signs that provide direction to, or information
15 about, permanent interior spaces of the site and facilities shall contain visual characters
16 complying with ICC A117.1.

17 **Exception:** Building directories, personnel names, company or occupant names and logos,
18 menus and temporary (seven days or less) signs are not required to comply with ICC A117.1.

19 **[W] SECTION 1112**

20 **TELEPHONES**

21 **1112.1 General.** Where coin-operated public pay telephones, coinless public pay telephones,
22 public closed-circuit telephones, courtesy phones or other types of public telephones are
23 provided, *accessible* public telephones shall be provided in accordance with Sections 1112.2

1 through 1112.5 for each type of public telephone provided. For purposes of this section, a bank
2 of telephones shall be considered two or more adjacent telephones.

3 **1112.2 Wheelchair-accessible telephones.** Where public telephones are provided, *wheelchair-*
4 *accessible* telephones shall be provided in accordance with Table 1112.2.

5 **Exception:** Drive-up-only public telephones are not required to be *accessible*.

6

| TABLE 1112.2 | |
|--|---|
| WHEELCHAIR-ACCESSIBLE TELEPHONES | |
| <u>NUMBER OF TELEPHONES PROVIDED ON A FLOOR, LEVEL OR EXTERIOR SITE</u> | <u>MINIMUM REQUIRED NUMBER OF WHEELCHAIR-ACCESSIBLE TELEPHONES</u> |
| <u>1 or more single unit</u> | <u>1 per floor, level and exterior site</u> |
| <u>1 bank</u> | <u>1 per floor, level and exterior site</u> |
| <u>2 or more banks</u> | <u>1 per bank</u> |

7
8 **1112.3 Volume controls.** All public telephones provided shall have accessible volume control.

9 **1112.4 TTYs.** TTYs shall be provided in accordance with Sections 1112.4.1 through 1112.4.9.

10 **1112.4.1 Bank requirement.** Where four or more public pay telephones are provided at a bank
11 of telephones, at least one public TTY shall be provided at that bank.

12 **Exception:** TTYs are not required at banks of telephones located within 200 feet (60 960
13 mm) of, and on the same floor as, a bank containing a public TTY.

14 **1112.4.2 Floor requirement.** Where four or more public pay telephones are provided on a
15 floor of a privately owned building, at least one public TTY shall be provided on that floor.

16 Where at least one public pay telephone is provided on a floor of a publicly owned building, at
17 least one public TTY shall be provided on that floor.

18 **1112.4.3 Building requirement.** Where four or more public pay telephones are provided in a
19 privately owned building, at least one public TTY shall be provided in the building. Where at

1 least one public pay telephone is provided in a publicly owned building, at least one public
2 TTY shall be provided in the building.

3 **1112.4.4 Site requirement.** Where four or more public pay telephones are provided on a site,
4 at least one public TTY shall be provided on the site.

5 **1112.4.5 Rest stops, emergency road stops, and service plazas.** Where a public pay
6 telephone is provided at a public rest stop, emergency road stop or service plaza, at least one
7 public TTY shall be provided.

8 **1112.4.6 Hospitals.** Where a public pay telephone is provided in or adjacent to a hospital
9 emergency room, hospital recovery room or hospital waiting room, at least one public TTY
10 shall be provided at each such location.

11 **1112.4.7 Transportation facilities.** Transportation facilities shall be provided with TTYs in
12 accordance with Sections 1114.2.5 and 1115.2 in addition to the TTYs required by Sections
13 1112.4.1 through 1112.4.4.

14 **1112.4.8 Detention and correctional facilities.** In detention and correctional facilities, where a
15 public pay telephone is provided in a secured area used only by detainees or inmates and
16 security personnel, then at least one TTY shall be provided in at least one secured area.

17 **1112.4.9 Signs.** Public TTYs shall be identified by the International Symbol of TTY complying
18 with ICC A117.1. Directional signs indicating the location of the nearest public TTY shall be
19 provided at banks of public pay telephones not containing a public TTY. Additionally, where
20 signs provide direction to public pay telephones, they shall also provide direction to public
21 TTYs. Such signs shall comply with visual signage requirements in ICC A117.1 and shall
22 include the International Symbol of TTY.

1 **1112.5 Shelves for portable TTYs.** Where a bank of telephones in the interior of a building
2 consists of three or more public pay telephones, at least one public pay telephone at the bank
3 shall be provided with a shelf and an electrical outlet.

4 **Exceptions:**

- 5 1. In secured areas of detention and correctional facilities, if shelves and outlets are
6 prohibited for purposes of security or safety shelves and outlets for TTYs are not required
7 to be provided.
- 8 2. The shelf and electrical outlet shall not be required at a bank of telephones with a TTY.

9 **[W] SECTION 1113**

10 **BUS STOPS**

11 **1113.1 General.** Bus stops shall comply with Sections 1113.2 through 1113.5.

12 **1113.2 Bus boarding and alighting areas.** Bus boarding and alighting areas shall comply with
13 Sections 1113.2.1 through 1113.2.4.

14 **1113.2.1 Surface.** Bus boarding and alighting areas shall have a firm, stable surface.

15 **1113.2.2 Dimensions.** Bus boarding and alighting areas shall have a clear length of 96 inches
16 (2440 mm) minimum, measured perpendicular to the curb or vehicle roadway edge, and a clear
17 width of 60 inches (1525 mm) minimum, measured parallel to the vehicle roadway.

18 **1113.2.3 Connection.** Bus boarding and alighting areas shall be connected to streets, sidewalks
19 or pedestrian paths by an accessible route complying with Section 1104.

20 **1113.2.4 Slope.** Parallel to the roadway, the slope of the bus boarding and alighting area shall
21 be the same as the roadway, to the maximum extent practicable. For water drainage, a
22 maximum slope of 1:48 perpendicular to the roadway is allowed.

1 **1113.3 Bus shelters.** Where provided, new or replaced bus shelters shall provide a minimum
2 clear floor or ground space complying with ICC A117.1, Section 305, entirely within the shelter.
3 Such shelters shall be connected by an accessible route to the boarding area required by Section
4 1113.2.

5 **1113.4 Signs.** New bus route identification signs shall have finish and contrast complying with
6 ICC A117.1. Additionally, to the maximum extent practicable, new bus route identification signs
7 shall provide visual characters complying with ICC A117.1.

8 **Exception:** Bus schedules, timetables and maps that are posted at the bus stop or bus bay are
9 not required to meet this requirement.

10 **1113.5 Bus stop siting.** Bus stop sites shall be chosen such that, to the maximum extent
11 practicable, the areas where lifts or ramps are to be deployed comply with Sections 1113.2 and
12 1113.3.

13 **[W] SECTION 1114**

14 **TRANSPORTATION FACILITIES AND STATIONS**

15 **1114.1 General.** Fixed transportation facilities and stations shall comply with the applicable
16 provisions of Section 1114.2.

17 **1114.2 New construction.** New stations in rapid rail, light rail, commuter rail, intercity rail, high
18 speed rail and other fixed guideway systems shall comply with Sections 1114.2.1 through
19 1114.2.8.

20 **1114.2.1 Station entrances.** Where different entrances to a station serve different
21 transportation fixed routes or groups of fixed routes, at least one entrance serving each group
22 or route shall comply with Section 1104.

1 **1114.2.2 Signs.** Signage in fixed transportation facilities and stations shall comply with
2 Sections 1114.2.2.1 through 1114.2.2.3.

3 **1114.2.2.1 Raised character and braille signs.** Where signs are provided at entrances to
4 stations identifying the station or the entrance, or both, at least one sign at each entrance shall
5 be raised characters and braille. A minimum of one raised character and braille sign
6 identifying the specific station shall be provided on each platform or boarding area. Such
7 signs shall be placed in uniform locations at entrances and on platforms or boarding areas
8 within the transit system to the maximum extent practicable.

9 **Exceptions:**

- 10 1. Where the station has no defined entrance but signs are provided, the raised
11 characters and braille signs shall be placed in a central location.
12 2. Signs are not required to be raised characters and braille where audible signs are
13 remotely transmitted to hand-held receivers, or are user or proximity actuated.

14 **1114.2.2.2 Identification signs.** Stations covered by this section shall have identification
15 signs containing visual characters complying with ICC A117.1. Signs shall be clearly visible
16 and within the sightlines of a standing or sitting passenger from within the train on both sides
17 when not obstructed by another train.

18 **1114.2.2.3 Informational signs.** Lists of stations, routes and destinations served by the
19 station which are located on boarding areas, platforms or mezzanines shall provide visual
20 characters complying with ICC A117.1 Signs covered by this provision shall, to the
21 maximum extent practicable, be placed in uniform locations within the transit system.

22 **1114.2.3 Fare machines.** Self-service fare vending, collection and adjustment machines shall
23 comply with ICC A117.1, Section 707. Where self-service fare vending, collection or

1 adjustment machines are provided for the use of the general public, at least one accessible
2 machine of each type provided shall be provided at each accessible point of entry and exit.

3 **1114.2.4 Rail-to-platform height.** Station platforms shall be positioned to coordinate with
4 vehicles in accordance with the applicable provisions of 36 CFR, Part 1192. Low-level
5 platforms shall be 8 inches (250 mm) minimum above top of rail.

6 **Exception:** Where vehicles are boarded from sidewalks or street level, low-level platforms
7 shall be permitted to be less than 8 inches (250 mm).

8 **1114.2.5 TTYs.** Where a public pay telephone is provided in a transit facility (as defined by the
9 Department of Transportation) at least one public TTY complying with ICC A117.1, Section
10 704.4, shall be provided in the station. In addition, where one or more public pay telephones
11 serve a particular entrance to a transportation facility, at least one TTY telephone complying
12 with ICC A117.1, Section 704.4, shall be provided to serve that entrance.

13 **1114.2.6 Track crossings.** Where a circulation path serving boarding platforms crosses tracks,
14 an accessible route shall be provided.

15 **Exception:** Openings for wheel flanges shall be permitted to be 2-1/2 inches (64 mm)
16 maximum.

17 **1114.2.7 Public address systems.** Where public address systems convey audible information
18 to the public, the same or equivalent information shall be provided in a visual format.

19 **1114.2.8 Clocks.** Where clocks are provided for use by the general public, the clock face shall
20 be uncluttered so that its elements are clearly visible. Hands, numerals and digits shall contrast
21 with the background either light-on-dark or dark-on-light. Where clocks are mounted overhead,
22 numerals and digits shall comply with visual character requirements.

1 **[W] SECTION 1115**

2 **AIRPORTS**

3 **1115.1 New construction.** New construction of airports shall comply with Sections 1115.2
4 through 1115.4.

5 **1115.2 TTYs.** Where public pay telephones are provided, at least one TTY shall be provided in
6 compliance with ICC A117.1, Section 704.4. Additionally, if four or more public pay telephones
7 are located in a main terminal outside the security areas, a concourse within the security areas or
8 a baggage claim area in a terminal, at least one public TTY complying with ICC A117.1, Section
9 704.4, shall also be provided in each such location.

10 **1115.3 Terminal information systems.** Where terminal information systems convey audible
11 information to the public, the same or equivalent information shall be provided in a visual
12 format.

13 **1115.4 Clocks.** Where clocks are provided for use by the general public, the clock face shall be
14 uncluttered so that its elements are clearly visible. Hands, numerals and digits shall contrast with
15 the background either light-on-dark or dark-on-light. Where clocks are mounted overhead,
16 numerals and digits shall comply with visual character requirements.

17 Section 12. The following sections of Chapter 12 of the International Building Code,
18 2015 Edition, are amended as follows:

19 **CHAPTER 12**

20 **INTERIOR ENVIRONMENT**

21 *******

22 **SECTION 1203**

23 **VENTILATION**

1 **[W] 1203.1 General.** Buildings shall be provided with natural ventilation in accordance with
2 Section 1203.5, or mechanical ventilation in accordance with the *International Mechanical*
3 *Code*.

4 ~~((Where the air infiltration rate in a *dwelling unit* is less than 5 air changes per hour when~~
5 ~~tested with a blower door at a pressure 0.2 inch w.e. (50 Pa) in accordance with Section 402.4.1.2~~
6 ~~of the *International Energy Conservation Code Residential Provisions*, the *dwelling unit* shall be~~
7 ~~ventilated by mechanical means in accordance with Section 403 of the *International Mechanical*~~
8 ~~*Code*.)~~ Ambulatory care facilities and Group I-2 occupancies shall be ventilated by mechanical
9 means in accordance with Section 407 of the *International Mechanical Code*.

10 **1203.2 ((Ventilation required)) Attic spaces.** Enclosed *attics* and enclosed rafter spaces formed
11 where ceilings are applied directly to the underside of roof framing members shall have cross
12 ventilation for each separate space by ventilation openings protected against the entrance of rain
13 and snow. Blocking and bridging shall be arranged so as not to interfere with the movement of
14 air. An airspace of not less than 1 inch (25 mm) shall be provided between the insulation and the
15 roof sheathing. The net free ventilating area shall be not less than 1/150 of the area of the space
16 ventilated. Ventilators shall be installed in accordance with manufacturer's installation
17 instructions.

18 **Exception:** The net free cross-ventilation area shall be permitted to be reduced to 1/300

19 ~~((provided both of the following conditions are met:~~

20 1. ~~In Climate Zones 6, 7 and 8, a Class I or II vapor retarder is installed on the warm in-~~
21 ~~winter side of the ceiling.~~

22 2. ~~A))~~ if at least 40 percent and not more than 50 percent of the required venting area is
23 provided by ventilators located in the upper portion of the *attic* or rafter space. Upper

1 ventilators shall be located not more than 3 feet (914 mm) below the ridge or highest
2 point of the space, measured vertically, with the balance of the *ventilation* provided
3 by eave or cornice vents. Where the location of wall or roof framing members
4 conflicts with the installation of upper ventilators, installation more than 3 feet (914
5 mm) below the ridge or highest point of the space shall be permitted.

6 ***

7 **1203.3 Unvented attic and unvented enclosed rafter assemblies.** Unvented attics and
8 unvented enclosed roof framing assemblies created by ceilings applied directly to the underside
9 of the roof framing members/rafters and the structural roof sheathing at the top of the roof
10 framing members shall be permitted where all the following conditions are met:

- 11 1. The unvented *attic* space is completely within the *building thermal envelope*.
- 12 2. No interior Class I vapor retarders are installed on the ceiling side (*attic* floor) of the
13 unvented *attic* assembly or on the ceiling side of the unvented enclosed roof framing
14 assembly.
- 15 3. Where wood shingles or shakes are used, a minimum ¼ inch (6.4 mm) vented airspace
16 separates the shingles or shakes and the roofing underlayment above the structural sheathing.

17 ~~((4. In Climate Zones 5, 6, 7 and 8, any air-impermeable insulation shall be a Class II vapor
18 retarder or shall have a Class II vapor retarder coating or covering in direct contact with the
19 underside of the insulation.))~~

20 ~~((5))4.~~ Insulation shall be located in accordance with the following:

- 21 ~~((5))4.1.~~ Item ~~((5))4.1.1~~, ~~((5))4.1.2~~, ~~((5))4.1.3~~ or ~~((5))4.1.4~~ shall be met, depending on the
22 air permeability of the insulation directly under the structural roof sheathing.

1 ((5))4.1.1. Where only air-impermeable insulation is provided, it shall be applied in direct
2 contact with the underside of the structural roof sheathing.

3 ((5))4.1.2. Where air-permeable insulation is provided inside the building thermal
4 envelope, it shall be installed in accordance with Item ((5))4.1. In addition to the air-
5 permeable insulation installed directly below the structural sheathing, rigid board or sheet
6 insulation shall be installed directly above the structural roof sheathing and shall have a
7 minimum R value of 10 (~~in accordance with the R values in Table 1203.3~~) for
8 condensation control.

9 ((5))4.1.3. Where both air-impermeable and air-permeable insulation are provided, the air-
10 impermeable insulation shall be applied in direct contact with the underside of the
11 structural roof sheathing in accordance with Item ((5))4.1.1 and shall have a minimum R
12 value of 10 (~~be in accordance with the R values in Table 1203.3~~) for condensation
13 control. The air-permeable insulation shall be installed directly under the air- impermeable
14 insulation.

15 ((5))4.1.4. Alternatively, sufficient rigid board or sheet insulation shall be installed directly
16 above the structural roof sheathing to maintain the monthly average temperature of the
17 underside of the structural roof sheathing above 45°F (7°C). For calculation purposes, an
18 interior air temperature of 68°F (20°C) is assumed and the exterior air temperature is
19 assumed to be the monthly average outside air temperature of the three coldest months.

20 ((5))4.2. Where preformed insulation board is used as the *air-impermeable insulation layer*, it
21 shall be sealed at the perimeter of each individual sheet interior surface to form a continuous
22 layer.

Exception((s)):

((1.))Section 1203.3 does not apply to special use structures or enclosures such as swimming pool enclosures, data processing centers, hospitals or art galleries.

((2. Section 1203.3 does not apply to enclosures in Climate Zones 5 through 8 that are humidified beyond 35 percent during the three coldest months.))

| ((TABLE 1203.3 INSULATION FOR CONDENSATION CONTROL | |
|---|---|
| CLIMATE ZONE | MINIMUM R-VALUE OF AIR- IMPERMEABLE INSULATION^a |
| 2B and 3B tile roof only | 0 (none required) |
| 1, 2A, 2B, 3A, 3B, 3C | R-5 |
| 4C | R-10 |
| 4A, 4B | R-15 |
| 5 | R-20 |
| 6 | R-25 |
| 7 | R-30 |
| 8 | R-35 |

a. Contributes to, but does not supersede, thermal resistance requirements for attic and roof assemblies in Section C402.2.1 of the *International Energy Conservation Code*.)

1203.4 Under-floor ventilation. The space between the bottom of the floor joists and the earth under any building except spaces occupied by basements or cellars shall be provided with ventilation openings through foundation walls or *exterior walls*. Such openings shall be placed so as to provide cross ventilation of the under-floor space. A ground cover of six mil (0.006 inch thick) black polyethylene or approved equal shall be laid over the ground within crawl spaces. The ground cover shall be overlapped six inches minimum at the joints and shall extend to the foundation wall.

Exception: The ground cover may be omitted in crawl spaces if the crawl space has a concrete slab floor with a minimum thickness of two inches.

1 **[W] 1203.5 Natural ventilation.** Where provided in other than Group R occupancies,
2 ((N))natural ventilation of an occupied space shall be through windows, doors, louvers or other
3 openings to the outdoors. The operating mechanism for such openings shall be provided with
4 ready access so that the openings are readily controllable by the building occupants. Group R
5 occupancies shall comply with the *International Mechanical Code*.

6 ***

7 **[W] 1203.7 Crawlspace ventilation.** All crawlspaces shall be ventilated as specified in Section
8 1203.3. If the installed ventilation in a crawlspace is less than one square foot for each 300
9 square feet of crawlspace area, or if the crawlspace vents are equipped with operable louvers, a
10 radon vent shall be installed to originate from a point between the ground cover and soil. The
11 radon vent shall be installed in accordance with Sections 1203.7.2 through 1203.7.6.

12 **1203.7.1 Crawlspace plenum systems.** In crawlspace plenum systems used for providing
13 supply air for an HVAC system, aggregate, a permanently sealed soil gas retarder membrane
14 and a radon vent pipe shall be installed in accordance with Section 1203.7.2 through 1203.7.6.

15 Crawlspaces shall not be used for return air plenums.

16 In addition, an operable radon vent fan shall be installed and activated. The fan shall be
17 located as specified in Section 1203.7.6. The fan shall be capable of providing at least 100 cfm
18 at 1-inch water column static pressure. The fan shall be controlled by a readily accessible
19 manual switch. The switch shall be labeled "RADON VENT FAN."

20 **1203.7.2 Aggregate.** A layer of aggregate of 4-inch minimum thickness shall be placed beneath
21 concrete slabs. The aggregate shall be continuous to the extent practical.

1 **1203.7.2.1 Aggregate grade.** Aggregate shall:

2 1. Comply with ASTM Standard C-33 Standard Specification for Concrete Aggregate and
3 shall be size No. 8 or larger size aggregate as listed in Table 2, Grading Requirements for
4 Coarse Aggregate; or

5 2. Meet the 1988 Washington State Department of Transportation Specification 9-03.1 (3)
6 "Coarse Aggregate for Portland Cement Concrete," or any equivalent successor standards.
7 Aggregate size shall be of Grade 8 or larger as listed in Section 9-03.1 (3) C, "Grading"; or

8 3. Be screened, washed pea gravel free of deleterious substances in a manner consistent with
9 ASTM Standard C-33 with 100 percent passing a 1/2-inch sieve and less than 5 percent
10 passing a No. 16 sieve. Sieve characteristics shall conform to those acceptable under
11 ASTM Standard C-33.

12 **Exception:** Aggregate shall not be required if a substitute material or system, with
13 sufficient load-bearing characteristics, and having approved capability to provide equal or
14 superior air flow, is installed.

15 **1203.7.3 Soil-gas retarder membrane.** A soil-gas retarder membrane, consisting of at least
16 one layer of virgin polyethylene with a thickness of at least 6 mil, or equivalent flexible sheet
17 material, shall be either placed directly under all concrete slabs so that the slab is in direct
18 contact with the membrane, or on top of the aggregate with 2 inches minimum of fine sand or
19 pea gravel installed between the concrete slab and membrane. The flexible sheet shall extend to
20 the foundation wall or to the outside edge of the monolithic slab. Seams shall overlap at least
21 12 inches. The membrane shall also be fitted tightly to all pipes, wires, and other penetrations
22 of the membrane and sealed with an approved sealant or tape. All punctures or tears shall be
23 repaired with the same or approved material and similarly lapped and sealed.

1 **1203.7.4 Sealing of penetrations and joints.** All penetrations and joints in concrete slabs or
2 other floor systems and walls below grade shall be sealed by an approved sealant to create an
3 air barrier to limit the movement of soil-gas into the indoor air.

4 Sealants shall be approved by the manufacturer for the intended purpose. Sealant joints
5 shall conform to manufacturer's specifications. The sealant shall be placed and tooled in
6 accordance with manufacturer's specifications. There shall be no gaps or voids after the sealant
7 has cured.

8 **1203.7.5 Radon vent.** One continuous sealed pipe shall run from a point within the aggregate
9 under each concrete slab to a point outside the building. Joints and connections shall be
10 permanently gas tight. The continuous sealed pipe shall interface with the aggregate in the
11 following manner, or by other approved equal method. The pipe shall be permanently
12 connected to a "T" within the aggregate area so that the two end openings of the "T" lie within
13 the aggregate area. A minimum of 5 feet of perforated drain pipe of 3 inches minimum
14 diameter shall join to and extend from the "T." The perforated pipe shall remain in the
15 aggregate area and shall not be capped at the ends. The "T" and its perforated pipe extensions
16 shall be located at least 5 feet horizontally from the exterior perimeter of the aggregate area.

17 The continuous sealed pipe shall terminate no less than 12 inches above the eave, and more
18 than 10 horizontal feet from a woodstove or fireplace chimney, or operable window. The
19 continuous sealed pipe shall be labeled "radon vent." The label shall be placed so as to remain
20 visible to an occupant.

21 The minimum pipe diameter shall be 3 inches unless otherwise approved. Acceptable
22 sealed plastic pipe shall be smooth walled, and may include either PVC schedule 40 or
23 ABS schedule of equivalent wall thickness.

1 The entire sealed pipe system shall be sloped to drain to the subslab aggregate.

2 The sealed pipe system may pass through an unconditioned attic before exiting the
3 building; but to the extent practicable, the sealed pipe shall be located inside the thermal
4 envelope of the building in order to enhance passive stack venting.

5 **Exception:** A fan for subslab depressurization system includes the following:

6 1. Soil-gas retarder membrane as specified in Section 1203.7.3;

7 2. Sealing of penetrations and joints as specified in Section 1203.7.4;

8 3. A 3-inch continuous sealed radon pipe shall run from a point within the aggregate
9 under each concrete slab to a point outside the building;

10 4. Joints and connections shall be gas tight, and may be of either PVC schedule 40 or
11 ABS schedule of equivalent wall thickness;

12 5. A label of "radon vent" shall be placed on the pipe so as to remain visible to an
13 occupant;

14 6. Fan circuit and wiring as specified in Section 1203.7.6 and a fan.

15 If the subslab depressurization system is exhausted through the concrete foundation wall or
16 rim joist, the exhaust terminus shall be a minimum of 6 feet from operable windows or outdoor
17 air intake vents and shall be directed away from operable windows and outdoor air intake vents
18 to prevent radon reentrainment.

19 **1203.7.6 Fan circuit and wiring and location.** An area for location of an in-line fan shall be
20 provided. The location shall be as close as practicable to the radon vent pipe's point of exit
21 from the building, or shall be outside the building shell; and shall be located so that the fan and
22 all downstream piping is isolated from the indoor air. Provisions shall be made to allow future

1 activation of an inline fan on the radon vent pipe without the need to place new wiring. A 110
2 volt power supply shall be provided at a junction box near the fan location.

3 SECTION 1204

4 TEMPERATURE CONTROL

5 **1204.1 Equipment and systems.** Interior spaces intended for human occupancy shall be
6 provided with active or passive space heating systems capable of maintaining an average indoor
7 temperature of not less than 68°F (20°C) at a point 3 feet (914 mm) above the floor ((~~on the~~
8 design heating day)) when the outside temperature is 24°F.

9 **Exceptions:** Space heating systems are not required for:

10 1. Interior spaces where the primary purpose of the space is not associated with human
11 comfort.

12 2. Group F, H, S or U occupancies.

13 [W] 3. Group R-1 occupancies not more than 500 square feet (139 m²) in area.

14 See the *International Energy Conservation Code* and *International Mechanical Code* for
15 additional requirements for heating systems.

16 [W] 1204.2 Use of solid-fuel-burning devices.

17 1204.2.1 Definitions. For the purposes of this section only, the following definitions apply.

18 **DESIGNATED AREAS.** Those areas designated by a county to be an urban growth area in

19 Chapter 36.70A RCW and those areas designated by the U.S. Environmental Protection

20 Agency as being in nonattainment for particulate matter.

21 **SUBSTANTIALLY REMODELED.** Any alteration or restoration of a building exceeding 60

22 percent of the appraised value of such building within a 12-month period. For the purpose of

1 this section, the appraised value is the estimated cost to replace the building and structure in
2 kind, based on current replacement costs.

3 **1204.2.2 Primary heating source.** Primary heating sources in all new and substantially
4 remodeled buildings in designated areas shall not be dependent upon wood stoves.

5 **1204.2.3 Solid fuel burning devices.** No new or used solid fuel burning device shall be
6 installed in new or existing buildings unless such device is United States Environmental
7 Protection Agency certified or exempt from certification by the United States Environmental
8 Protection Agency and conforms with RCW 70.94.011, 70.94.450, 70.94.453 and 70.94.457.

9 **Exceptions:**

10 1. Wood cook stoves.

11 2. Antique wood heaters manufactured prior to 1940.

12 **SECTION 1205**

13 **LIGHTING**

14 ***

15 **1205.4 Stairway illumination.** *Stairways within dwelling units and exterior stairways serving a*
16 *dwelling unit shall have an illumination level on tread runs of not less than 1 footcandle (11 lux).*
17 *Stairways in other occupancies shall be governed by Chapter 10.*

18 **1205.4.1 Controls.** The control for activation of the required stairway lighting shall be in
19 accordance with ((NFPA-70)) the *Seattle Electrical Code* and the *International Energy*
20 *Conservation Code.*

21 ***

22 **SECTION 1206**

23 **YARDS OR COURTS**

1206.3.3 Court drainage. The bottom of every court shall be properly graded and drained to a public sewer or other *approved* disposal system complying with the ~~((International))~~ Uniform Plumbing Code.

SECTION 1207

SOUND TRANSMISSION

1207.1 Scope. This section shall apply to common interior walls, partitions and floor/ceiling assemblies between adjacent *dwelling units* and *sleeping units* or between *dwelling units* and *sleeping units* and adjacent public areas such as halls, *corridors*, *stairways* or *service areas*.

1207.2 Air-borne sound. Walls, partitions and floor/ceiling assemblies separating *dwelling units* and *sleeping units* from each other or from public or service areas shall have a sound transmission class of not less than 50, or not less than 45 if field tested, for air-borne noise when tested in accordance with ASTM E 90. Penetrations or openings in construction assemblies for piping; electrical devices; recessed cabinets; bathtubs; soffits; or heating, ventilating or exhaust ducts shall be sealed, lined, insulated or otherwise treated to maintain the required ratings. ~~((This requirement shall not apply to entrance doors; however, such doors shall be tight fitting to the frame and sill.))~~

Dwelling unit or guest room entrance doors from interior corridors and interconnecting doors between separate units shall have perimeter seals. Such door assemblies shall have a sound transmission class (STC) rating of not less than 28.

1207.2.1 Masonry. The sound transmission class of concrete masonry and clay masonry assemblies shall be calculated in accordance with TMS 0302 or determined through testing in accordance with ASTM E 90.

1 **1207.3 Structure-borne sound.** Floor/ceiling assemblies between *dwelling units* and *sleeping*
2 *units* or between a *dwelling unit* or *sleeping unit* and a public or service area within the structure
3 shall have an impact insulation class rating of not less than 50, or not less than 45 if field tested,
4 when tested in accordance with ASTM E 492.

5 **Exception:** Floor assemblies in the bathrooms of Group R-1 occupancies are not required to
6 meet the impact insulation class of 50 where structural concrete floor systems are used.

7 Joints in the perimeter of the separating wall or floor-ceiling assemblies shall be acoustically
8 sealed with a permanent resilient material approved for the purpose. The separating wall or
9 floor-ceiling assembly shall extend completely to and be sealed to another separating assembly
10 or an exterior wall, roof or floor assembly.

11 Conduits, ducts, pipes and vents within the wall or floor-ceiling assemblies causing vibration
12 shall be reasonably isolated from the building construction at points of support by means of
13 resilient sleeves, mounts or underlayments. All other openings through which such conduits,
14 ducts, pipes or vents pass shall have the excess opening fully sealed with insulative and
15 permanently resilient materials approved for the purpose.

16 Electrical outlet boxes shall not be placed back-to-back and shall be offset by not less than 12
17 inches (305 mm) from outlets in the opposite wall surface. The back and sides of boxes shall be
18 sealed with one-eighth-inch resilient sealant and backed by a minimum of 2-inch (51 mm) thick
19 material fiber insulation or approved equivalent.

20 Metal ventilating and conditioned air ducts which pass between dwelling units shall be
21 fabricated and installed to maintain required sound transmission ratings.

22 **1207.4 Tested assemblies.** Field- or laboratory-tested wall or floor-ceiling designs having an
23 STC or IIC of 50 or more are permitted to be used without additional field testing when, in the

1 opinion of the *building official*, the tested design has not been compromised by flanking paths.

2 The *building official* is permitted to require tests when evidence of compromised separations is
3 noted.

4 **1207.5 Field testing and certification.** Field testing, when permitted to determine airborne
5 sound transmission or impact sound insulation class, shall be done in accordance with ASTM E
6 336 or ASTM E 492 under the supervision of an acoustical professional who is experienced in
7 the field of acoustical testing and engineering and who shall forward certified test results to the
8 building official that minimum sound insulation requirements stated above have been met.

9 **1207.6 Mechanical equipment spaces.** Spaces or shafts containing air conditioning,
10 refrigeration or ventilating equipment, elevator machinery, or other mechanical equipment shall
11 be separated both vertically and horizontally from adjoining dwelling units or guest rooms by
12 construction designed to provide a minimum STC rating of 50.

13 **1207.7 Sound transmission control systems.** Generic systems as listed in GA 600 shall be
14 accepted where a laboratory test indicates that the requirements of Section 1207 are met by the
15 system.

16 **Note:** Design and materials for sound transmission control shall not impair the fire-resistive
17 integrity of separating walls or floor-ceiling assemblies required to be of fire-resistive
18 construction.

19 **SECTION 1208**

20 **INTERIOR SPACE DIMENSIONS**

21 ***

1 **1208.2 Minimum ceiling heights.** Occupiable spaces, *habitable spaces* and *corridors* shall have
2 a ceiling height of not less than 7 feet 6 inches (2286 mm). Bathrooms, toilet rooms, kitchens,
3 storage rooms and laundry rooms shall have a ceiling height of not less than 7 feet (2134 mm).

4 **Exceptions:**

- 5 1. In one- and two-family *dwelling*s, beams or girders spaced not less than 4 feet (1219 mm)
6 on center shall be permitted to project not more than 6 inches (152 mm) below the
7 required ceiling height.
- 8 2. If any room in a building has a sloped ceiling, the prescribed ceiling height for the room
9 is required in one-half the area thereof. Any portion of the room measuring less than 5
10 feet (1524 mm) from the finished floor to the ceiling shall not be included in any
11 computation of the minimum area thereof.
- 12 3. The height of *mezzanines* and spaces below *mezzanines* shall be in accordance with
13 Section 505(~~(-1)~~).
- 14 4. Corridors contained within a *dwelling unit* or *sleeping unit* in Group R occupancy shall
15 have a ceiling height of not less than 7 feet (2134 mm).
- 16 5. Ceiling height in the means of egress shall comply with Section 1003.2.

17 Notwithstanding the exceptions to Section 1208.2, protruding objects in circulation routes in
18 spaces required to be accessible shall comply with Chapter 11 and ANSI A117.1 Section 307.

19 **1208.2.1 Furred ceiling.** Any room with a furred ceiling shall be required to have the
20 minimum ceiling height in two-thirds of the area thereof, but in no case shall the height of the
21 furred ceiling be less than 7 feet (2134 mm).

1 **1208.3 Room area.** Every *dwelling unit* shall have no fewer than one room that shall have not
2 less than 120 square feet (13.9 m²) of *net floor area*. Other habitable rooms shall have a *net floor*
3 *area* of not less than 70 square feet (6.5 m²).

4 **Exception:** Kitchens are not required to be of a minimum floor area.

5 **1208.4 Efficiency dwelling units.** An *efficiency ((living)) dwelling unit* shall conform to the
6 requirements of the code except as modified herein:

- 7 1. The unit shall have a living room of not less than 220 square feet (20.4 m²) of floor area.
8 An additional 100 square feet (9.3 m²) of floor area shall be provided for each occupant
9 of such unit in excess of two.

10 **Interpretation I1208.4:** The required square footage shall not include built-in equipment
11 that extends from floor to ceiling such as wardrobes, cabinets, kitchen units or fixtures.

- 12 2. The unit shall be provided with a separate closet.
- 13 3. The unit shall be provided with a kitchen sink, cooking appliance and refrigeration
14 facilities, each having a clear working space of not less than 30 inches (762 mm) in front.
15 Light and *ventilation* conforming to this code shall be provided.
- 16 4. The unit shall be provided with a separate bathroom containing a water closet, lavatory
17 and bathtub or shower.

18 ***

19 Section 13. The following sections of Chapter 14 of the International Building Code,
20 2015 Edition, are amended as follows:

21 **CHAPTER 14**

22 **EXTERIOR WALLS**

23 ***

SECTION 1403

PERFORMANCE REQUIREMENTS

1403.1 General. The provisions of this section shall apply to exterior walls, wall coverings and components thereof.

1403.2 Weather protection. Exterior walls shall provide the building with a weather-resistant *exterior wall envelope*. The *exterior wall envelope* shall include flashing, as described in Section 1405.4. The *exterior wall envelope* shall be designed and constructed in such a manner as to prevent the accumulation of water within the wall assembly by providing a *water-resistive barrier* behind the exterior veneer, as described in Section 1404.2, and a means for draining water that enters the assembly to the exterior. ~~((Protection against condensation in the *exterior wall* assembly shall be provided in accordance with Section 1405.3.))~~ An air space cavity is not required under the exterior cladding for an exterior wall clad with lapped or panel siding made of plywood, engineered wood, hardboard, or fiber cement. Protection against condensation in the exterior wall assembly shall be provided in accordance with Section 1405.3.

Exceptions:

1. A weather-resistant *exterior wall envelope* shall not be required over concrete or masonry walls designed in accordance with Chapters 19 and 21, respectively.
2. Compliance with the requirements for a means of drainage, and the requirements of Sections 1404.2 and 1405.4, shall not be required for an *exterior wall envelope* that has been demonstrated through testing to resist wind-driven rain, including joints, penetrations and intersections with dissimilar materials, in accordance with ASTM E 331 under the following conditions:

1 2.1 Exterior wall envelope test assemblies shall include at least one opening,
2 one control joint, one wall/eave interface and one wall sill. Tested
3 openings and penetrations shall be representative of the intended end-use
4 configuration.

5 2.2 Exterior wall envelope test assemblies shall be at least 4 feet by 8 feet
6 (1219 mm by 2438 mm) in size.

7 2.3 Exterior wall envelope assemblies shall be tested at a minimum
8 differential pressure of 6.24 pounds per square foot (psf) (0.297 kN/m²).

9 2.4 *Exterior wall envelope* assemblies shall be subjected to a minimum test
10 exposure duration of 2 hours.

11 The *exterior wall envelope* design shall be considered to resist wind-driven rain
12 where the results of testing indicate that water did not penetrate control joints in the
13 *exterior wall* envelope, joints at the perimeter of openings or intersections of
14 terminations with dissimilar materials.

15 3. Exterior insulation and finish systems (EIFS) complying with Section 1408.4.1.

16 **Interpretation I1403.2:** According to Section 1403.2, a rain screen or similar construction
17 method is not required for most exterior siding and cladding, and single-wall construction is
18 allowed. Drainage methods should conform to the manufacturer’s installation instructions and
19 other sections of the code.

20 **Note:** The “water-resistive barrier” behind the exterior wall covering provides “drainage” of the
21 water that may enter an exterior wall envelope. If water penetrates the exterior wall covering,
22 the felt paper or other approved material will direct the water to the bottom of the wall where it
23 will escape to the exterior.

1 ***

2 ~~((1403.5 Vertical and lateral flame propagation. Exterior walls on buildings of Type I, II, III or~~
3 ~~IV construction that are greater than 40 feet (12192 mm) in height above grade plane and contain~~
4 ~~a combustible water resistive barrier shall be tested in accordance with and comply with the~~
5 ~~acceptance criteria of NFPA 285. For the purposes of this section, fenestration products and~~
6 ~~flashing of fenestration products shall not be considered part of the water resistive barrier.~~

7 **Exceptions:**

- 8 1. ~~Walls in which the water resistive barrier is the only combustible component and the~~
9 ~~exterior wall has a wall covering of brick, concrete, stone, terra cotta, stucco or steel~~
10 ~~with minimum thicknesses in accordance with Table 1405.2.~~
- 11 2. ~~Walls in which the water resistive barrier is the only combustible component and the~~
12 ~~water resistive barrier has a peak heat release rate of less than 150 kW/m², a total heat~~
13 ~~release of less than 20 MJ/m² and an effective heat of combustion of less than 18~~
14 ~~MJ/kg as determined in accordance with ASTM E 1354 and has a flame spread index~~
15 ~~of 25 or less and a smoke developed index of 450 or less as determined in accordance~~
16 ~~with ASTM E 84 or UL 723. The ASTM E 1354 test shall be conducted on specimens~~
17 ~~at the thickness intended for use, in the horizontal orientation and at an incident radiant~~
18 ~~heat flux of 50 kW/m².)~~

19 ***

20 **SECTION 1405**

21 **INSTALLATION OF WALL COVERINGS**

22 ***

1 **1405.3 Vapor retarders.** Vapor retarders as described in Section 1405.3.3 shall be provided in
2 accordance with Sections 1405.3.1 and 1405.3.2, or an approved design using accepted
3 engineering practice for hygrothermal analysis.

4 **1405.3.1 Class I and II vapor retarders.** (~~Class I and II vapor retarders shall not be provided~~
5 ~~on the interior side of frame walls in Zones 1 and 2. Class I vapor retarders shall not be provided~~
6 ~~on the interior side of frame walls in Zones 3 and 4.)) Class I or II vapor retarders shall be
7 provided on the interior side of frame walls (~~in Zones 5, 6, 7, 8 and Marine 4. The appropriate~~
8 ~~zone shall be selected in accordance with Chapter 3 of the *International Energy Conservation*~~
9 ~~*Code-Commercial Provisions.*)~~)~~

10 **Exceptions:**

- 11 1. Basement walls.
- 12 2. Below-grade portion of any wall.
- 13 3. Construction where moisture or its freezing will not damage the materials.
- 14 4. Conditions where Class III vapor retarders are required in Section 1405.3.2.

15 ***

**TABLE 1405.3.2
 CLASS III VAPOR RETARDERS**

| ZONE | CLASS III VAPOR RETARDERS PERMITTED FOR:^a |
|---|---|
| Marine 4 | Vented cladding over wood structural panels Vented cladding over fiberboard Vented cladding over gypsum Insulated sheathing with R -value $\geq R2.5$ over 2×4 wall Insulated sheathing with R -value $\geq R3.75$ over 2×6 wall |
| ((5 | Vented cladding over wood structural panels Vented cladding over fiberboard Vented cladding over gypsum Insulated sheathing with R -value $\geq R5$ over 2×4 wall Insulated sheathing with R -value $\geq R7.5$ over 2×6 wall |
| 6 | Vented cladding over fiberboard Vented cladding over gypsum Insulated sheathing with R -value $\geq R7.5$ over 2×4 wall Insulated sheathing with R -value $\geq R11.25$ over 2×6 wall |
| 7 and 8 | Insulated sheathing with R -value $\geq R10$ over 2×4 wall Insulated sheathing with R -value $\geq R15$ over 2×6 wall)) |
| For SI: 1 pound per cubic foot = 16 kg/m ³ . a. Spray foam with a minimum density of 2 lbs/ft ³ applied to the interior cavity side of wood structural panels, fiberboard, insulating sheathing or gypsum is deemed to meet the insulating sheathing requirement where the spray foam R -value meets or exceeds the specified insulating sheathing R -value. | |

1 **1405.3.3 Material vapor retarder class.** The *vapor retarder class* shall be based on the
 2 manufacturer’s certified testing or a tested assembly.

3 The following shall be deemed to meet the class specified:

4 Class I: Sheet polyethylene, nonperforated aluminum foil with a perm rating of less than or
 5 equal to 0.1.

6 Class II: Kraft-faced fiberglass batts or paint with a perm rating greater than 0.1 and less
 7 than or equal to 1.0.

8 Class III: Latex or enamel paint with a perm rating of greater than 1.0 and less than or
 9 equal to 10.0.

10 **Note:** Minimum perm ratings for vapor retarders are specified in the definition of “vapor
 11 retarder class” in Chapter 2.

12 ***

13 **SECTION 1408**

14 **EXTERIOR INSULATION AND FINISH SYSTEMS (EIFS)**

15 ***

1 ~~((1408.6 Special inspections. EIFS installations shall comply with the provisions of Sections~~
2 ~~1704.2 and 1705.16.))~~

3 ***

4 Section 14. The following sections of Chapter 15 of the International Building Code,
5 2015 Edition, are amended as follows:

6 **CHAPTER 15**

7 **ROOF ASSEMBLIES AND ROOFTOP STRUCTURES**

8 ***

9 **SECTION 1503**

10 **WEATHER PROTECTION**

11 ***

12 **[P] 1503.4 Roof drainage.** Design and installation of roof drainage systems shall comply with
13 Section 1503 of this code and Sections 1106 and 1108, as applicable, of the ~~((International))~~
14 Uniform Plumbing Code.

15 **[P] 1503.4.1 Secondary (emergency overflow) drains or scuppers.** Where roof drains are
16 required, secondary (emergency overflow) roof drains or scuppers shall be provided where
17 the roof perimeter construction extends above the roof in such a manner that water will be
18 entrapped if the primary drains allow buildup for any reason. The installation and sizing of
19 secondary emergency overflow drains, leaders and conductors shall comply with Sections
20 1106 and 1108, as applicable, of the ~~((International))~~ Uniform Plumbing Code.

21 ***

22 **SECTION 1505**

23 **FIRE CLASSIFICATION**

1 **[BF] 1505.1 General.** Roof assemblies shall be divided into the classes defined below. Class A,
2 B and C roof assemblies and roof coverings required to be listed by this section shall be tested in
3 accordance with ASTM E 108 or UL 790. In addition, *fire-retardant-treated wood* roof coverings
4 shall be tested in accordance with ASTM D 2898. The minimum roof coverings installed on
5 buildings shall comply with Table 1505.1 based on the type of construction of the building.

6 **Exception:** Skylights and sloped glazing that comply with Chapter 24 or Section 2610.

7

| IA | IB | IIA | IIB | IIIA | IIIB | IV | VA | VB |
|----|----|-----|----------------|------|----------------|----|----|----------------|
| B | B | B | C ^c | B | C ^c | B | B | C ^c |

For SI: 1 foot = 304.8 mm, 1 square foot = 0.0929 m².
(~~a. Unless otherwise required in accordance with the *International Wildland-Urban Interface Code* or due to the location of the building within a fire district in accordance with Appendix D.~~)
b. Nonclassified roof coverings shall be permitted on buildings of Group R-3 and Group U occupancies, where there is a minimum fire separation distance of 6 feet measured from the leading edge of the roof.
c. Buildings that are not more than two stories above grade plane and having not more than 6,000 square feet of projected roof area and where there is a minimum 10-foot fire-separation distance from the leading edge of the roof to a lot line on all sides of the building, except for street fronts or public ways, shall be permitted to have roofs of No. 1 cedar or redwood shakes and No. 1 shingles constructed in accordance with Section 1505.7.

8 ***

9 **SECTION 1510**

10 **ROOFTOP STRUCTURES**

11 ***

12 **[BG] 1510.2.3 Use limitations.** Penthouses shall not be used for purposes other than the shelter
13 of mechanical or electrical equipment, tanks, exit stairways or vertical shaft openings in the roof
14 assembly.

15 ***

1 ~~(([BG] 1510.9 Structural fire resistance. The structural frame and roof construction supporting~~
2 ~~imposed loads upon the roof by any rooftop structure shall comply with the requirements of~~
3 ~~Table 601. The fire resistance reduction permitted by Table 601, Note a, shall not apply to roofs~~
4 ~~containing rooftop structures.))~~

SECTION 1511

REROOFING

7 Note: See International Energy Conservation Code for insulation requirements for reroofing.

8 ***

9 Section 15. The following sections of Chapter 16 of the International Building Code,
10 2015 Edition, are amended as follows:

CHAPTER 16

STRUCTURAL DESIGN

SECTION 1601

GENERAL

15 **1601.1 Scope.** The provisions of this chapter shall govern the structural design of buildings,
16 structures and portions thereof regulated by this code.

Exceptions:

18 1. Carports are not required to comply with this chapter if they satisfy all the following

19 criteria:

20 1.1. Accessory to Group R-3 occupancies,

21 1.2. Used to shelter only vehicles, trailers or vessels,

22 1.3. Constructed of metal, plastic or fabric,

23 1.4. No more than 3 pounds per square foot in total weight, and

1 4. *Seismic design category and site class.*

2 5. Flood design data, if located in *flood hazard areas* established in Section 1612.3.

3 6. Design load-bearing values of soils.

4 **1603.1.1 Floor live load.** The uniformly distributed, concentrated and impact floor live load
5 used in the design shall be indicated for floor areas. Use of live load reduction in accordance
6 with Section 1607.10 shall be indicated for each type of live load used in the design.

7 **1603.1.2 Roof and snow live load.** The roof and snow live loads used in the design shall be
8 indicated for roof areas (Section 1607.12 and 1608).

9 **1603.1.3 Reserved.** (~~Roof snow load data.~~ The ground snow load, P_g , shall be indicated. In
10 areas where the ground snow load, P_g , exceeds 10 pounds per square foot (psf) (0.479 kN/m²),
11 the following additional information shall also be provided, regardless of whether snow loads
12 govern the design of the roof:

13 1. — Flat roof snow load, P_f

14 2. — Snow exposure factor, C_e .

15 3. — Snow load importance factor, I_s .

16 4. — Thermal factor, C_t .

17 5. — Drift surcharge load(s), P_d , where the sum of P_d and P_f exceeds 20 psf (0.96 kN/m²).

18 6. — Width of snow drift(s), w .)

19 ***

20 **1603.1.8 Special loads.** Special loads that are applicable to the design of the building, structure
21 or portions thereof shall be indicated along with the specified section of this code that
22 addresses the special loading condition.

1603.1.8.1 Photovoltaic panel systems. The dead load of rooftop-mounted *photovoltaic panel systems*, including rack support systems, shall be indicated on the *construction documents*.

Note: Floor and roof design load provisions regarding posting of live loads, issuance of certificates of occupancy and restrictions on loading are located in Section 107 Floor and Roof Design Loads.

SECTION 1605

LOAD COMBINATIONS

1605.2 Load combinations using strength design or load and resistance factor design. Where strength design or load and resistance factor design is used, buildings and other structures, and portions thereof, shall be designed to resist the most critical effects resulting from the following combinations of factored loads:

$$1.4(D + F) \quad \text{(Equation 16-1)}$$

$$1.2(D + F) + 1.6(L + H) + 0.5(L_r \text{ or } S \text{ or } R) \quad \text{(Equation 16-2)}$$

$$1.2(D + F) + 1.6(L_r \text{ or } S \text{ or } R) + 1.6H + (f_1L \text{ or } 0.5W) \quad \text{(Equation 16-3)}$$

$$1.2(D + F) + 1.0W + f_1L + 1.6H + 0.5(L_r \text{ or } S \text{ or } R) \quad \text{(Equation 16-4)}$$

$$1.2(D + F) + 1.0E + f_1L + 1.6H + f_2S \quad \text{(Equation 16-5)}$$

$$0.9D + 1.0W + 1.6H \quad \text{(Equation 16-6)}$$

$$0.9(D + F) + 1.0E + 1.6H \quad \text{(Equation 16-7)}$$

where:

$f_1 = 1$ for places of public assembly live loads in excess of 100 pounds per square foot (4.79 kN/m²), and parking garages; and 0.5 for other live loads.

1 $f_2 = 0.7$ for roof configurations (such as saw tooth) that do not shed snow off the structure, and
2 0.2 for other roof configurations.

3 **Exceptions:**

- 4 1. Where other factored load combinations are specifically required by other provisions of
5 this code, such combinations shall take precedence.
6 2. Where the effect of H resists the primary variable load effect, a load factor of 0.9 shall
7 be included with H where H is permanent and H shall be set to zero for all other
8 conditions.

9 **Interpretation I1605:** The lateral pressure on basement and retaining walls due to
10 earthquake motions, as required in Section 1803.5.12, is permitted to be considered as an
11 earthquake load E for the purposes of use in load combinations.

12 ***

13 **SECTION 1606**

14 **DEAD LOADS**

15 ***

16 **1606.3 Solar zone for solar-ready roof.** Where a *solar zone* is required by the *International*
17 *Energy Conservation Code*, it shall be designed for an assumed dead load of 5 pounds per square
18 foot in addition to other required live and dead loads. An area of 2 square feet for each 1000
19 square feet of solar zone area shall be designed for an assumed dead load of 175 pounds per
20 square foot. If the actual weight of the system at the time of installation exceeds the assumed
21 loads in this section, the actual weight shall be used to verify the adequacy of the roof structure.
22 This area shall be located within or adjacent to the solar zone. The as-designed dead load and
23 live load for the *solar zone* shall be clearly marked on the construction documents.

Note: The 175 psf represents the weight of the inverters necessary for PV systems. See *International Energy Conservation Code Section C412.*

SECTION 1607

LIVE LOADS

**TABLE 1607. 1
MINIMUM UNIFORMLY DISTRIBUTED LIVE LOAD, L_0 , AND MINIMUM
CONCENTRATED LIVE LOADS^g**

| OCCUPANCY OR USE | UNIFORM (psf) | CONCENTRATED (pounds) |
|---|---|-----------------------|
| 1. Apartments (see residential) | — | — |
| 2. Access floor systems | | |
| Office use | 50 | 2,000 |
| Computer use | 100 | 2,000 |
| 3. Armories and drill rooms | 150 ^m | — |
| 4. Assembly areas | | |
| Fixed seats (fastened to floor) | 60 ^m | |
| Follow spot, projections and control rooms | 50 | |
| Lobbies | 100 ^m | — |
| Movable seats | 100 ^m | |
| Stage floors | 150 ^m | |
| Platforms (assembly) | 100 ^m | |
| Other assembly areas | 100 ^m | |
| 5. Balconies and decks ^{h, i} | Same as occupancy served | — |
| 6. Catwalks | 40 | 300 |
| 7. Canopies ^g and Cornices | 60 | — |
| 8. Corridors | | |
| First floor | 100 | — |
| Other floors | Same as occupancy served except as indicated | — |
| 9. Dining rooms and restaurants | 100 ^m | — |
| 10. Dwellings (see residential) | — | — |
| 11. Elevator machine room and control room grating (on area of 2 inches by 2 inches) | — | 300 |
| 12. Finish light floor plate construction (on area of 1 inch by 1 inch) | — | 200 |
| 13. Fire escapes | 100 | |
| On single-family dwellings only | 40 | — |
| 14. Garages (passenger vehicles only) | 40 ^m | Note a |
| Trucks and buses | See Section 1607.7 | See Section 1607.7 |
| 15. Handrails, guards and grab bars | See Section 1607.8 | |
| 16. Helipads | See Section 1607.6 | |

**TABLE 1607. 1
MINIMUM UNIFORMLY DISTRIBUTED LIVE LOAD, L_0 , AND MINIMUM
CONCENTRATED LIVE LOADS^g**

| OCCUPANCY OR USE | UNIFORM (psf) | CONCENTRATED (pounds) |
|--|---------------------|--------------------------|
| 17. Hospitals | | |
| Corridors above first floor | 80 | 1,000 |
| Operating rooms, laboratories | 60 | 1,000 |
| Patient rooms | 40 | 1,000 |
| 18. Hotels (see residential) | — | — |
| 19. Libraries | | |
| Corridors above first floor | 80 | 1,000 |
| Reading rooms | 60 | 1,000 |
| Stack rooms | 150 ^{b, m} | 1,000 |
| 20. Manufacturing | | |
| Heavy | 250 ^m | 3,000 |
| Light | 125 ^m | 2,000 |
| 21. ((Marquees, except one and two family dwellings)) <u>Reserved</u> | ((75)) | —)) |
| 22. Office buildings | | |
| Corridors above first floor | 80 | 2,000 |
| File and computer rooms shall be designed for heavier loads based on anticipated occupancy | — | — |
| Lobbies and first-floor corridors | 100 | 2,000 |
| Offices | 50 | 2,000 |
| 23. Penal institutions | | |
| Cell blocks | 40 | — |
| Corridors | 100 | |
| 24. Recreational uses: | | |
| Bowling alleys, poolrooms and similar uses | 75 ^m | |
| Dance halls and ballrooms | 100 ^m | |
| Gymnasiums | 100 ^m | |
| Ice skating rink | 250 ^m | — |
| Reviewing stands, grandstands and bleachers | 100 ^{c, m} | |
| Rolling skating rink | 100 ^m | |
| Stadiums and arenas with fixed seats (fastened to floor) | 60 ^{c, m} | |
| 25. Residential | | |
| One- and two-family dwellings | | |
| Uninhabitable attics without storage ⁱ | 10 | |
| Uninhabitable attics with storage ^{i, j, k} | 20 | |
| Habitable attics and sleeping areas ^k | 30 | |
| Canopies, including marquees | 20 | — |
| All other areas | 40 | |
| Hotels and multifamily dwellings | | |
| Private rooms and corridors serving them | 40 | |
| Public rooms ^m and corridors serving them | 100 | |
| 26. Roofs | | |
| All roof surfaces subject to maintenance workers | | 300 |
| Awnings and canopies: | | |
| Fabric construction supported by a skeleton structure | 5 Nonreducible | |

**TABLE 1607. 1
MINIMUM UNIFORMLY DISTRIBUTED LIVE LOAD, L_0 , AND MINIMUM
CONCENTRATED LIVE LOADS^g**

| OCCUPANCY OR USE | UNIFORM (psf) | CONCENTRATED (pounds) |
|---|----------------------|-----------------------|
| All other construction, except one- and two-family dwellings. | 20 | |
| Ordinary flat, pitched, and curved roofs (that are not occupiable) | 20 | |
| Primary roof members exposed to a work floor. | | |
| Single panel point of lower chord of roof trusses or any point along primary structural members supporting roofs over manufacturing, storage warehouses, and repair garages | | 2,000 |
| All other primary roof members | | 300 |
| Occupiable roofs: | | |
| Roof gardens | 100 | |
| Assembly areas | 100 ^m | |
| All other similar areas | Note 1 | Note 1 |
| 27. Schools | | |
| Classrooms | 40 | 1000 |
| Corridors above first floor | 80 | 1000 |
| First-floor corridors | 100 | 1000 |
| 28. Scuttles, skylight ribs and accessible ceilings | — | 200 |
| 29. Sidewalks, vehicular driveways and yards, subject to trucking | 250 ^{d, m} | 8,000 ^e |
| 30. Stairs and exits | | |
| One- and two-family dwellings | 40 | 300 ^f |
| All other | 100 | 300 ^f |
| 31. Storage warehouses (shall be designed for heavier loads if required for anticipated storage) | | |
| Heavy | 250 ^m | — |
| Light | 125 ^m | |
| 32. Stores | | |
| Retail | | |
| First floor | 100 | 1000 |
| Upper floors | 75 | 1000 |
| Wholesale, all floors | 125 ^m | 1000 |
| 33. Vehicle barriers | See Section 1607.8.3 | |
| 34. Walkways and elevated platforms (other than exitways) | 60 | — |
| 35. Yards and terraces, pedestrians | 100 ^m | — |
| For SI: 1 inch = 25.4 mm, 1 square inch = 645.16mm ² , 1 square foot = 0.0929m ² , 1 pound per square foot = 0.0479kN/m ² , 1 pound = 0.004448 kN, 1 pound per cubic foot = 16 kg/m ³ . a. Floors in garage or portions of buildings used for the storage of motor vehicles shall be designed for the uniformly distributed live loads of this Table or the following concentrated loads: (1) for garages restricted to passenger vehicles accommodating not more than nine passengers, 3,000 pounds acting on an area of 4 ½ inches by 4 ½ inches; (2) for mechanical parking structures without slab or deck that are used for storing passenger vehicles only, 2,250 pounds per wheel. | | |

TABLE 1607. 1
MINIMUM UNIFORMLY DISTRIBUTED LIVE LOAD, L_0 , AND MINIMUM
CONCENTRATED LIVE LOADS^g

| OCCUPANCY OR USE | UNIFORM (psf) | CONCENTRATED (pounds) |
|--|---------------|-----------------------|
| <p>b. The loading applies to stack room floors that support nonmobile, double-faced library book stacks, subject to the following limitations:</p> <ol style="list-style-type: none"> 1. The nominal book stack unit height shall not exceed 90 inches; 2. The nominal shelf depth shall not exceed 12 inches for each face; and 3. Parallel rows of double-faced book stacks shall be separated by aisles not less than 36 inches wide. <p>c. Design in accordance with ICC 300.</p> <p>d. Other uniform loads in accordance with an approved method containing provisions for truck loadings shall be considered where appropriate.</p> <p>e. The concentrated wheel load shall be applied on an area of 4.5 inches by 4.5 inches.</p> <p>f. The minimum concentrated load on stair treads shall be applied on an area of 2 inches by 2 inches. This load need not be assumed to act concurrently with the uniform load.</p> <p>(g. Where snow loads occur that are in excess of the design conditions, the structure shall be designed to support the loads due to the increased loads caused by the drift buildup or a greater snow design determined by the building official (see Section 1608).)</p> <p><u>g. This loading condition need only be considered for canopies that meet all of the following conditions:</u></p> <ol style="list-style-type: none"> <u>1. The upper surface is sloped less than 30 degrees (0.5 rad) from horizontal; and</u> <u>2. The canopy is located adjacent to a right of way or assembly area; and</u> <u>3. The canopy is located less than 10 feet (3048 mm) above the ground at all points, or less than 10 feet (3048 mm) below an adjacent roof, or less than 10 feet (3048 mm) from operable openings above or adjacent to the level of the canopy.</u> <p><u>For other canopies, roof loads as specified in this chapter shall be applied.</u></p> <p><u>Canopy is defined in Section 202.</u></p> <p>h. See Section 1604.8.3 for decks attached to exterior walls.</p> <p>i. Uninhabitable attics without storage are those where the maximum clear height between the joists and rafters is less than 42 inches, or where there are not two or more adjacent trusses with web configurations capable of accommodating an assumed rectangle 42 inches in height by 24 inches in width, or greater, within the plane of the trusses. This live load need not be assumed to act concurrently with any other live load requirements.</p> <p>j. Uninhabitable attics with storage are those where the maximum clear height between the joists and rafters is 42 inches or greater, or where there are two or more adjacent trusses with web configurations capable of accommodating an assumed rectangle 42 inches in height by 24 inches in width, or greater, within the plane of the trusses.</p> <p>The live load need only be applied to those portions of the joists or truss bottom chords where both of the following conditions are met:</p> <ol style="list-style-type: none"> i. The attic area is accessible from an opening not less than 20 inches in width by 30 inches in length that is located where the clear height in the attic is a minimum of 30 inches; and ii. The slopes of the joists or truss bottom chords are no greater than two units vertical in 12 units horizontal. <p>The remaining portions of the joists or truss bottom chords shall be designed for a uniformly distributed concurrent live load of not less than 10 pounds per square foot.</p> <p>k. Attic spaces served by stairways other than the pull-down type shall be designed to support the minimum live load specified for habitable attics and sleeping rooms.</p> <p>l. Areas of occupiable roofs, other than roof gardens and assembly areas, shall be designed for appropriate loads as approved by the <i>building official</i>. Unoccupied landscaped areas of roofs shall be designed in accordance with Section 1607.12.3.</p> <p>m. Live load reduction is not permitted unless specific exceptions of Section 1607.10 apply.</p> <p><u>n. Decks and balconies that are accessed only from a dwelling unit or private office shall comply with live load requirements of the occupancy served. Other decks and balconies are considered "other assembly areas."</u></p> | | |

1

2 **1607.7.5 Posting.** The maximum weight of vehicles allowed into or on a garage or other

3 structure shall be posted by the owner or the owner's authorized agent in accordance with

4 Section ~~((106.4))~~ 107.

1
2 **1607.12 Roof loads.** The structural supports of roofs and (~~(marquees)~~) canopies shall be
3 designed to resist wind and, where applicable, snow and earthquake loads, in addition to the dead
4 load of construction and the appropriate live loads as prescribed in this section (~~(or as set forth~~
5 ~~in Table 1607.1)~~). The live loads acting on a sloping surface shall be assumed to act vertically on
6 the horizontal projection of that surface.

7 **1607.12.1 Distribution of roof loads.** Where uniform roof live loads are reduced to less than
8 20 psf (0.96 kN/m²) in accordance with Section 1607.12.2.1 and are applied to the design of
9 structural members arranged so as to create continuity, the reduced roof live load shall be
10 applied to adjacent spans or to alternate spans, whichever produces the most unfavorable *load*
11 *effect*. See Section 1607.12.2 for reductions in minimum roof live loads and Section 7.5 of
12 ASCE 7 for (~~(partial)~~) snow loading.

13 **1607.12.2 General.** The minimum uniformly distributed live loads of roofs and (~~(marquees)~~)
14 canopies, L_O , in Table 1607.1 are permitted to be reduced in accordance with Section
15 1607.12.2.1.

16 **1607.12.2.1 Ordinary roofs, awnings and canopies.** Ordinary flat, pitched and curved
17 roofs, and awnings and canopies other than of fabric construction supported by a skeleton
18 structure, are permitted to be designed for a reduced uniformly distributed roof live load,
19 L_r , as specified in the following equations or other controlling combinations of loads as
20 specified in Section 1605, whichever produces the greater *load effect*.

21 In structures such as greenhouses, where special scaffolding is used as a work surface
22 for workers and materials during maintenance and repair operations, a lower roof load than
23 specified in the following equations shall not be used unless *approved* by the *building*

official. Such structures shall be designed for a minimum roof live load of 12 psf (0.58 kN/m²).

$$L_r = L_0 R_1 R_2 \quad \text{(Equation 16-26)}$$

where: $12 \leq L_r \leq 20$

For SI: $L_r = L_0 R_1 R_2$

where: $0.58 \leq L_r \leq 0.96$

L_0 = Unreduced roof live load per square foot (m²) of horizontal projection supported by the member (see Table 1607.1).

L_r = Reduced roof live load per square foot (m²) of horizontal projection supported by the member.

The reduction factors R_1 and R_2 shall be determined as follows:

$$R_1 = 1 \text{ for } A_t \leq 200 \text{ square feet (18.58 m}^2\text{)} \quad \text{(Equation 16-27)}$$

$$R_1 = 1.2 - 0.001A_t \text{ for } 200 \text{ square feet} \\ < A_t < 600 \text{ square feet} \quad \text{(Equation 16-28)}$$

For SI: $1.2 - 0.011A_t$ for 18.58 square meters $< A_t <$ 55.74 square meters

$$R_1 = 0.6 \text{ for } A_t \geq 600 \text{ square feet (55.74 m}^2\text{)} \quad \text{(Equation 16-29)}$$

where:

A_t = Tributary area (span length multiplied by effective width) in square feet (m²) supported by the member, and

$$R_2 = 1 \text{ for } F \leq 4 \quad \text{(Equation 16-30)}$$

$$R_2 = 1.2 - 0.05 F \text{ for } 4 < F < 12 \quad \text{(Equation 16-31)}$$

$$R_2 = 0.6 \text{ for } F \geq 12 \quad \text{(Equation 16-32)}$$

where:

F = For a sloped roof, the number of inches of rise per foot (for SI: $F = 0.12 \times$ slope, with slope expressed as a percentage), or for an arch or dome, the rise-to-span ratio multiplied by 32.

1607.12.3 Occupiable roofs. Areas of roofs that are occupiable, such as *vegetative roofs*, roof gardens or for assembly or other similar purposes, and (~~marquees~~) canopies are permitted to have their uniformly distributed live loads reduced in accordance with Section 1607.10.

SECTION 1608

SNOW LOADS

1 **1608.1 General.** Roofs shall be designed for a uniform snow load of at least 25 psf (1200 Pa).
2 Design snow loads shall be permitted to be determined in accordance with Chapter 7 of ASCE 7,
3 but the design roof load shall not be less than that determined by Section 1607.

4 ***

5 SECTION 1612

6 FLOOD LOADS

7 ***

8 **1612.3 Establishment of flood hazard areas.** (~~To establish *flood hazard areas*, the applicable~~
9 ~~governing authority shall adopt a flood hazard map and supporting data. The flood hazard map~~
10 ~~shall include, at a minimum, areas of special flood hazard as identified by the Federal Emergency~~
11 ~~Management Agency in an engineering report entitled “The Flood Insurance Study for [INSERT~~
12 ~~NAME OF JURISDICTION],” dated [INSERT DATE OF ISSUANCE], as amended or~~
13 ~~revised with the accompanying Flood Insurance Rate Map (FIRM) and Flood Boundary and~~
14 ~~Floodway Map (FBFM) and related supporting data along with any revisions thereto. The~~
15 ~~adopted)) The flood hazard map and supporting data adopted in Seattle Municipal Code Section
16 25.06.050 and areas mapped by Seattle Public Utilities are hereby adopted by reference and
17 declared to be part of this section.~~

18 ***

19 **1612.5 Flood hazard documentation.** The following documentation shall be prepared and
20 sealed by a *registered design professional* and submitted to the *building official*:

- 21 1. For construction in *flood hazard areas* other than *coastal high hazard areas* or
22 *coastal A zones*:

1 1.1. The elevation of the lowest floor, including the basement, as required by
2 the lowest floor elevation inspection in Section ((110.3.3)) 108.9.4 and for
3 the final inspection in Section ((110.3.10.1)) 108.9.9.1.

4 1.2. For fully enclosed areas below the design flood elevation where provisions
5 to allow for the automatic entry and exit of floodwaters do not meet the
6 minimum requirements in Section 2.6.2.1 of ASCE 24, *construction*
7 *documents* shall include a statement that the design will provide for
8 equalization of hydrostatic flood forces in accordance with Section 2.6.2.2
9 of ASCE 24.

10 1.3. For dry floodproofed nonresidential buildings, *construction documents*
11 shall include a statement that the dry floodproofing is designed in
12 accordance with ASCE 24.

13 2. For construction in *coastal high hazard areas* and *coastal A zones*:

14 2.1. The elevation of the bottom of the lowest horizontal structural member as
15 required by the lowest floor elevation inspection in Section ((110.3.3))
16 108.9.9 and for the final inspection in Section ((110.3.10.1)) 108.9.9.1.

17 2.2. *Construction documents* shall include a statement that the building is
18 designed in accordance with ASCE 24, including that the pile or column
19 foundation and building or structure to be attached thereto is designed to
20 be anchored to resist flotation, collapse and lateral movement due to the
21 effects of wind and flood loads acting simultaneously on all building
22 components, and other load requirements of Chapter 16.

1 2.3. For breakaway walls designed to have a resistance of more than 20 psf
2 (0.96 kN/m²) determined using allowable stress design, *construction*
3 *documents* shall include a statement that the breakaway wall is designed in
4 accordance with ASCE 24.

5 ***

6 SECTION 1613

7 EARTHQUAKE LOADS

8 **1613.1 Scope.** Every structure, and portion thereof, including nonstructural components that are
9 permanently attached to structures and their supports and attachments, shall be designed and
10 constructed to resist the effects of earthquake motions in accordance with ASCE 7, excluding
11 Chapter 14 and Appendix 11A. The seismic design category for a structure is permitted to be
12 determined in accordance with Section 1613 or ASCE 7.

13 **Exceptions:**

- 14 1. Detached one- and two-family dwellings, assigned to Seismic Design Category A, B
15 or C, or located where the mapped short-period spectral response acceleration, S_s , is
16 less than 0.4 g.
- 17 2. The seismic force-resisting system of wood-frame buildings that conform to the
18 provisions of Section 2308 are not required to be analyzed as specified in this
19 section.
- 20 3. Agricultural storage structures intended only for incidental human occupancy.
- 21 4. Structures that require special consideration of their response characteristics and
22 environment that are not addressed by this code or ASCE 7 and for which other
23 regulations provide seismic criteria, such as vehicular bridges, electrical

1 transmission towers, hydraulic structures, buried utility lines and their appurtenances
2 and nuclear reactors.

3 **1613.1.1 Presubmittal conference.** At least 60 days prior to application, the applicant
4 shall arrange a presubmittal conference with the structural engineer of record and the
5 building official to review the proposed building structural system when it is not
6 defined in Table 12.2-1 in ASCE 7 or when an alternate procedure is used under the
7 provisions in Section 104.4 or 104.5. The purpose of the meeting is to obtain
8 conceptual approval from the building official of the proposed structural system.

9 ***

10 **1613.1 Scope.** Every structure, and portion thereof, including nonstructural components that are
11 permanently attached to structures and their supports and attachments, shall be designed and
12 constructed to resist the effects of earthquake motions in accordance with ASCE 7 as amended
13 by Section 1613.5, excluding Chapter 14 and Appendix 11A. The seismic design category for a
14 structure is permitted to be determined in accordance with Section 1613 or ASCE 7.

15 **Exceptions:**

- 16 1. Detached one- and two-family dwellings, assigned to Seismic Design Category A,
17 B or C, or located where the mapped short-period spectral response acceleration,
18 SS, is less than 0.4 g.
- 19 2. The seismic force-resisting system of wood-frame buildings that conform to the
20 provisions of Section 2308 are not required to be analyzed as specified in this
21 section.
- 22 3. Agricultural storage structures intended only for incidental human occupancy.
- 23 4. Structures that require special consideration of their response characteristics and
24 environment that are not addressed by this code or ASCE 7 and for which other

1 regulations provide seismic criteria, such as vehicular bridges, electrical
2 transmission towers, hydraulic structures, buried utility lines and their
3 appurtenances and nuclear reactors.

4 ***

5 **1613.5 Amendments to ASCE 7.** The provisions of Section 1613.5.1 shall be permitted as
6 an amendment to the relevant provisions of ASCE 7. The text of ASCE 7 shall be modified
7 as indicated in Section 1613.5.2 through 1613.5.3.

8 **1613.5.1 Transfer of anchorage forces into diaphragm.** Modify ASCE 7 Section
9 12.11.2.2.1 as follows:

10 12.11.2.2.1 Transfer of anchorage forces into diaphragm. Diaphragms shall be provided
11 with continuous ties or struts between diaphragm chords to distribute these anchorage
12 forces into the diaphragms. Diaphragm connections shall be positive, mechanical or
13 welded. Added chords are permitted to be used to form subdiaphragms to transmit the
14 anchorage forces to the main continuous cross-ties. The maximum length-to-width ratio
15 of a wood, wood structural panel or untopped steel deck sheathed structural
16 subdiaphragm that serves as part of the continuous tie system shall be 2.5 to 1.

17 Connections and anchorages capable of resisting the pre- scribed forces shall be provided
18 between the diaphragm and the attached components. Connections shall extend into the
19 diaphragm a sufficient distance to develop the force transferred into the diaphragm.

20 **1613.5.2. ASCE 7 Section 12.2.5.4.** Modify ASCE 7 Section 12.2.5.4 to read as follows:

21 **12.2.5.4 Increased Structural Height Limit for Steel Eccentrically Braced Frames,**
22 **Steel Special Concentrically Braced Frames, Steel Buckling-Restrained Braced**
23 **Frames, Steel Special Plate Shear Walls, and Special Reinforced Concrete Shear**

1 **Walls.** The limits on height, h_n , in Table 12.2-1 are permitted to be increased from 160 ft
2 (50 m) to 240 ft (75 m) for structures assigned to Seismic Design Categories D or E and
3 from 100 ft (30 m) to 150 ft (50 m) for structures assigned to Seismic Design Category F,
4 if all of the following are satisfied:

5 1. The structure shall not have an extreme torsional irregularity as defined in Table
6 12.3-1 (horizontal structural irregularity Type 1b).

7 2. The steel eccentrically braced frames, steel special concentrically braced frames,
8 steel buckling-restrained braced frames, steel special plate shear walls or special
9 reinforced concrete shear walls in any one plane shall resist no more than 60
10 percent of the total seismic forces in each direction, neglecting accidental torsional
11 effects.

12 3. Where floor and roof diaphragms transfer forces from the vertical seismic force-
13 resisting elements above the diaphragm to other vertical force-resisting elements
14 below the diaphragm, these in-plane transfer forces shall be amplified by the
15 overstrength factor, Ω_o for the design of the diaphragm flexure, shear, and
16 collectors.

17 4. The earthquake force demands in foundation mat slabs, grade beams, and pile caps
18 supporting braced frames and/or walls arranged to form a shear-resisting core shall
19 be amplified by 2 for shear and 1.5 for flexure.

20 5. The earthquake shear force demands in special reinforced concrete shear walls
21 shall be amplified by the overstrength factor, Ω_o .

22 **1613.5.3 ASCE 7 Table 12.6-1. Modify ASCE 7 Table 12.6-1 Permitted Analytical**
23 Procedures to read as follows:

Table 12.6-1 Permitted Analytical Procedures

| <u>Seismic Design Category</u> | <u>Structural Characteristics</u> | <u>Equivalent Lateral Force Procedure, Section 12.8^a</u> | <u>Modal Response Spectrum Analysis, Section 12.9^a</u> | <u>Linear Seismic Response History Procedures, Chapter 16^a</u> | <u>Nonlinear Seismic Response History Procedures, Chapter 16^b</u> |
|--------------------------------|---|---|---|---|--|
| <u>B, C</u> | <u>All structures</u> | <u>P</u> | <u>P</u> | <u>P</u> | <u>P</u> |
| <u>D, E, F</u> | <u>Risk Category I or II buildings not exceeding two stories above the base</u> | <u>P</u> | <u>P</u> | <u>P</u> | <u>P</u> |
| | <u>Structures of light frame construction</u> | <u>P</u> | <u>P</u> | <u>P</u> | <u>P</u> |
| | <u>Structures with no structural irregularities and not exceeding 160 ft in structural height</u> | <u>P</u> | <u>P</u> | <u>P</u> | <u>P</u> |
| | <u>Structures exceeding 160 ft in structural height with no structural irregularities and with $T < 3.5T_s$</u> | <u>P</u> | <u>P</u> | <u>P</u> | <u>P</u> |
| | <u>Structures not exceeding 160 ft in structural height and having only horizontal irregularities of Type 2, 3, 4, or 5 in Table 12.3-1 or vertical irregularities of Type 4, 5a, or 5b in Table 12.3-2</u> | <u>P</u> | <u>P</u> | <u>P</u> | <u>P</u> |
| | <u>All other structures \leq 240 ft in height</u> | <u>NP</u> | <u>P</u> | <u>P</u> | <u>P</u> |
| | <u>All structures $>$ 240 ft in height</u> | <u>NP</u> | <u>NP</u> | <u>NP</u> | <u>P^c</u> |

^a P: Permitted; NP: Not Permitted; $T_s = SD1/SDS$.

^b When nonlinear response history procedure is used, one of the linear procedures shall also be performed.

^c Refer to Section 12.6.2 for additional requirements.

1613.5.4. Modify ASCE 7 Section 12.6 by adding new Section 12.6.2 as follows:

12.6.2 Nonlinear Response History Procedure for Buildings in Excess of 240 ft in

Height. In addition to any of the linear analysis procedures in Table 12.6-1, a nonlinear dynamic analysis in accordance with ASCE 7 Chapter 16 shall be performed, except that

1 analysis shall be conducted for MCE_R ground motions. Acceptance criteria shall be
2 compatible with providing not greater than a 10 percent, 5 percent or 2-1/2 percent risk of
3 collapse for Risk Category II, III and IV structures, respectively. In addition,
4 proportioning of the seismic force-resisting system shall incorporate a capacity-based
5 approach that identifies the mechanism of nonlinear lateral displacement of the structure,
6 those structural actions expected to yield, and those intended to remain elastic. Design
7 shall be subject to an approved independent structural design review.

8 ***

9 Section 16. The following sections of Chapter 17 of the International Building Code,
10 2015 Edition, are amended as follows:

11 **CHAPTER 17**

12 **SPECIAL INSPECTIONS AND TESTS**

13 ***

14 **SECTION 1703**

15 **APPROVALS**

16 **1703.1 Approved agency.** Whenever tests or certification of any material or fabricated assembly
17 are required by this code, the tests or certification shall be made by an agency approved by the
18 building official to conduct the tests or provide the certification. The building official is
19 authorized to establish rules and regulations setting forth conditions and provisions for approval
20 of agencies and for the conduct of any agency so approved. An approved agency shall provide all
21 information as necessary for the building official to determine that the agency meets the
22 applicable requirements specified in Sections 1703.1.1 through 1703.1.3. The building official is
23 authorized to suspend or revoke approval of an agency upon evidence of failure of the agency to

1 properly conduct any test, certify any material, or to perform any inspection in a manner required
2 by this code.

3 **1703.1.1 Independence.** An *approved agency* shall be objective, competent and independent
4 from the contractor responsible for the work being inspected. The agency shall also disclose to
5 the *building official* and the *registered design professional in responsible charge* possible
6 conflicts of interest so that objectivity can be confirmed.

7 **1703.1.2 Equipment.** An *approved agency* shall have adequate equipment to perform
8 required tests. The equipment shall be periodically calibrated.

9 **1703.1.3 Personnel.** An *approved agency* shall employ experienced personnel educated in
10 conducting, supervising and evaluating tests and *special inspections*. Unless otherwise
11 approved by the building official, all special inspectors shall be registered with the
12 Washington Association of Building Officials. A registered civil or structural engineer or
13 registered architect is permitted to serve as a special inspector when approved by the
14 building official.

15 **1703.1.4 Approval of tests and inspections.** Special inspectors and inspection and testing
16 agencies shall not conduct any inspections or tests until the building official has authorized
17 the inspection or test in writing. The special inspectors or inspection/testing agency approved
18 by the building official shall not be changed without obtaining prior approval of the
19 registered design professional in responsible charge or the owner, and the building official.

20 ~~((1703.2 Written approval. Any material, appliance, equipment, system or method of~~
21 ~~construction meeting the requirements of this code shall be approved in writing after satisfactory~~
22 ~~completion of the required tests and submission of required test reports.~~

1 ~~**1703.3 Record of approval.** For any material, appliance, equipment, system or method of~~
2 ~~construction that has been *approved*, a record of such approval, including the conditions and~~
3 ~~limitations of the approval, shall be kept on file in the *building official's* office and shall be~~
4 ~~available for public review at appropriate times.))~~

5 **1703.4 Performance.** Specific information consisting of test reports conducted by an *approved*
6 *agency* in accordance with the appropriate referenced standards, or other such information as
7 necessary, shall be provided for the *building official* to determine that the product, material or
8 assembly meets the applicable code requirements.

9 **1703.4.1 Research and investigation.** ((Sufficient)) If approved by the *building official*,
10 technical data shall be submitted to the *building official* to substantiate the proposed use of
11 any product, material or assembly. If it is determined that the evidence submitted is
12 satisfactory proof of performance for the use intended, the *building official* shall approve the
13 use of the product, material or assembly subject to the requirements of this code. The costs,
14 reports and investigations required under these provisions shall be paid by the owner or the
15 owner's authorized agent.

16 ***

17 **1703.7 Preconstruction conference.** For projects requiring *special inspection*, the owner or the
18 owner's agent shall arrange a conference with the project contractor, the design team, the *special*
19 *inspection* agency and the *building official* prior to commencing work on any portion of
20 construction requiring *special inspection*. The purpose of the conference is to identify and clarify
21 the *special inspection* requirements of the project.

22 **1703.8 Revocation of registration or approval to inspect.** The *building official* is authorized to
23 revoke, suspend or refuse to renew registration or approval of inspection agencies, *special*

1 inspectors and nonregistered *special inspectors*, including inspectors registered by the
2 Washington Association of Building Officials. This may be done upon evidence submitted to the
3 *building official* of incompetence, of willful or negligent failure to observe or report violations of
4 the *Seattle Building Code* or of any other failure to perform properly and effectively the duties
5 required by this code or other duties assumed by an inspection agency or nonregistered *special*
6 *inspector*. The inspection agency or *special inspector* shall be notified in writing of the *building*
7 *official's* decision to revoke, suspend or refuse to renew registration or approval. The notice shall
8 be served in the manner set forth in RCW 4.28.080 for service of a summons or sent by first
9 class mail. For purposes of this section, service is complete at the time of personal service, or if
10 mailed, three days after the date of mailing. When the last day of the period so computed is a
11 Saturday, Sunday or City holiday, the period runs until 5 p.m. on the next business day.

12 **1703.8.1 Review by the building official for revocation of registration. Any person**

13 aggrieved by a notice of revocation issued pursuant to Section 1703.8 may obtain a review of
14 the notice by making a request in writing to the *building official* within three business days of
15 the date of service of the notice of revocation.

16 **1703.8.1.1 Review procedure.** The review shall occur within five business days after receipt

17 by the *building official* of the request for review unless otherwise agreed by the person
18 requesting the review. Any person aggrieved by or interested in the notice of revocation may
19 submit additional information to the *building official* for consideration as part of the review
20 at any time prior to the review. The review will be made by a representative of the *building*
21 *official* who will review all additional information received and may also request a site visit.

1 **1703.8.1.2 Decision.** After the review, the *building official* shall:

2 1. Sustain the notice of revocation and set or modify the date the revocation will take
3 effect;

4 2. Withdraw the notice of revocation;

5 3. Continue the review to a date certain; or

6 4. Modify the notice of revocation and set or modify the date the revocation will take
7 effect.

8 **1703.8.1.3 Order.** The *building official* shall issue an order containing the decision within ten
9 days after the review is completed and shall cause the order to be sent by regular first class
10 mail to the persons requesting the review, any other person on whom the notice of revocation
11 was served and any other person who requested a copy before issuance of the order of the
12 *building official*. The order of the *building official* is the final order of the City and all parties
13 are bound by the final order.

14 **SECTION 1704**

15 **SPECIAL INSPECTIONS AND TESTS, CONTRACTOR RESPONSIBILITY AND**
16 **STRUCTURAL OBSERVATION**

17 ***

18 **1704.2 Special inspections and tests.** Where application is made to the *building official* for
19 construction as specified in Section ((405)) 106, the owner or the owner's authorized agent, other
20 than the contractor, shall employ one or more *approved agencies* to provide *special inspections*
21 and tests during construction on the types of work specified in Section 1705 and identify the
22 *approved agencies* to the *building official*. The *building official* may require additional *special*
23 *inspectors* if the *building official* determines they are needed due to the magnitude or complexity

1 of the job. These *special inspections* and tests are in addition to the inspections by the *building*
2 *official* that are identified in Section ((110)) 108.

3 **Exceptions:**

- 4 1. *Special inspections* and tests are not required for construction of a minor nature or as
5 warranted by conditions in the jurisdiction as approved by the *building official*.
- 6 2. Unless otherwise required by the *building official*, *special inspections* and tests are
7 not required for Group U occupancies that are accessory to a residential occupancy
8 including, but not limited to, those listed in Section 312.1.
- 9 3. *Special inspections* and tests are not required for portions of structures designed
10 and constructed in accordance with the cold-formed steel light-frame construction
11 provisions of Section 2211.7 or the conventional light-frame construction provisions
12 of Section 2308.
- 13 4. The contractor is permitted to employ the *approved agencies* where the contractor
14 is also the owner.

15 **1704.2.1 Special inspector qualifications.** Prior to the start of the construction, the *approved*
16 *agencies* shall provide written documentation to the *building official* demonstrating the
17 competence and relevant experience or training of the *special inspectors* who will perform
18 the *special inspections* and tests during construction. Experience or training shall be
19 considered relevant where the documented experience or training is related in complexity to
20 the same type of *special inspection* or testing activities for projects of similar complexity and
21 material qualities. Unless otherwise approved by the building official, all special inspectors
22 shall be registered with the Washington Association of Building Officials. These
23 qualifications are in addition to qualifications specified in other sections of this code.

1 The *registered design professional in responsible charge* and engineers of record involved
2 in the design of the project are permitted to act as the *approved agency* and their personnel
3 are permitted to act as *special inspectors* for the work designed by them, provided they
4 qualify as *special inspectors*.

5 **1704.2.1.1 Registration of special inspectors.**

6 **1704.2.1.1.1 Application for registration.** Criteria for registration of *special inspectors*
7 shall be established by the *building official* by rule.

8 **1704.2.1.1.2 Issuance of certificate of registration.** If the *building official* is satisfied
9 that the applicant is qualified, a Certificate of Registration or a Limited Certificate of
10 Registration shall be issued that specifies the types of inspection the applicant has been
11 authorized to perform. Valid registration from the Washington Association of Building
12 Officials is permitted to substitute for registration by the *building official*.

13 **1704.2.1.1.3 Renewal of special inspector's registration.** A Certificate of Registration
14 or Limited Certificate of Registration is valid for the period of time to be determined by
15 the *building official* by rule. Upon application for renewal of a Certificate of Registration,
16 the *building official* is permitted to re-examine the applicant to ascertain his/her fitness to
17 perform the inspection of the type or types for which the application was made.

18 **1704.2.1.1.4 Revocation.** *Special inspectors'* certifications are subject to revocation
19 according to Section 1703.8.

20 **1704.2.2 Access for special inspection.** ((The)) It is the duty of the person requesting *special*
21 *inspections* to provide that construction or work for which *special inspection* or testing is
22 required ~~is~~ ((shall remain)) accessible and exposed for *special inspection* or testing purposes
23 until completion of the required *special inspections* or tests.

1 **1704.2.3 Statement of special inspections.** The applicant shall submit a statement of *special*
2 *inspections* (~~(in accordance with Section 107.1)~~) as a condition for permit issuance. This
3 statement shall be in accordance with Section 1704.3.

4 **Exception:** A statement of *special inspections* is not required for portions of structures
5 designed and constructed in accordance with the cold-formed steel light-frame
6 construction provisions of Section 2211.7 or the conventional light-frame construction
7 provisions of Section 2308.

8 ~~((1704.2.4 Report requirement. Approved agencies shall keep records of *special inspections*
9 and tests. The *approved agency* shall submit reports of *special inspections* and tests to the
10 *building official* and to the *registered design professional in responsible charge*. Reports shall
11 indicate that work inspected or tested was or was not completed in conformance to *approved*
12 *construction documents*. Discrepancies shall be brought to the immediate attention of the
13 contractor for correction. If they are not corrected, the discrepancies shall be brought to the
14 attention of the *building official* and to the *registered design professional in responsible*
15 *charge* prior to the completion of that phase of the work. A final report documenting required
16 *special inspections* and tests, and correction of any discrepancies noted in the inspections or
17 tests, shall be submitted at a point in time agreed upon prior to the start of work by the owner
18 or the owner's authorized agent to the *building official*.)~~

19 **1704.2.4 Responsibilities.**

20 **1704.2.4.1 Responsibilities of special inspector.** The *special inspector* is responsible for
21 conducting all *special inspections* for which the *special inspector* was employed and notified
22 and for carrying out the duties of a *special inspector* as specified in Section 1704.

1 **1704.2.4.1.1 Specific duties.** Registered *special inspectors* are regularly authorized
2 deputies of the *building official* and are subject to all duties imposed by the *building*
3 *official*, in addition to the following:

4 1. The registered *special inspector* shall be present during the execution of all assigned
5 work. The registered *special inspector* shall report to the job sufficiently in advance of
6 construction to become familiar with the plans and to inspect all materials to be used
7 or concealed within the work. The *special inspector* shall inspect the construction,
8 erection, placing, or other use of materials; and shall observe whether there is
9 compliance with the *approved* design as to all of the foregoing. During the execution
10 of all assigned work, the registered *special inspector* shall not undertake or engage in
11 any other task or occupation that interferes with the proper performance of the
12 inspection duties.

13 2. The registered *special inspector* shall not approve the placing of foundation concrete or
14 pile caps prior to the approval of the soil condition or pile driving reports by the
15 engineer who performed the *special inspection* for the pile installation.

16 3. The registered *special inspector* shall be employed only by an *approved* inspection or
17 testing agency.

18 4. The registered *special inspector* shall not inspect work performed, or material supplied,
19 by any contractor, subcontractor or material vendor with whom the inspector is
20 employed.

21 5. If any registered *special inspector* is negligent in the performance of the inspector's
22 duties, the *building official* is permitted to stop the work.

1 **1704.2.4.1.2 Daily reports.** The registered *special inspector* shall immediately report all
2 irregularities, substitution of materials and violations to the contractor for correction, then
3 if uncorrected, to the registered design professional in responsible charge and to the
4 building official. At the conclusion of each inspection, the registered *special inspector* shall
5 submit a report to the registered design professional in responsible charge and owner
6 relative to the portion of the work inspected, stating whether the work requiring special
7 inspection was, to the best of the special inspector's knowledge, in conformance with the
8 approved plans and specifications and the applicable workmanship provisions of this code
9 and related standards. The report shall be signed by the registered special inspector. One
10 copy of the report shall be submitted to the building official by the approved inspection or
11 testing agency no later than one week from the date of the inspection and shall be filed in
12 the records of the agency's office. One copy of the report shall be left at the job site by the
13 special inspector. The special inspector shall also provide, as directed by the building
14 official or by the registered design professional in responsible charge or owner, such other
15 information as is required during the special inspector's assigned employment.

16 **1704.2.4.1.3 Final report.** The inspection or testing agency shall submit a final signed
17 report listing the scope of required inspection and stating whether all work requiring
18 special inspection was, to the best of the agency's knowledge, inspected and reported as
19 specified on construction documents.

20 **1704.2.4.2 Responsibility of owner.** The owner or an authorized agent is responsible for
21 notifying the special inspector when construction activity is scheduled that requires special
22 inspection. If the owner designates another person to notify the special inspector, the owner
23 retains the responsibility to assure that the special inspections are conducted and required

1 reports submitted to the *building official*. The *approved* testing agency shall notify the
2 *building official* and the *registered design professional in responsible charge* or owner of the
3 commencement of inspection of a job and shall specify the type of inspection for which the
4 special inspector has been engaged. This notification shall be made prior to commencement
5 of inspection. The *approved* testing agency shall notify the *building official* prior to
6 commencement of each day's inspection thereafter. The *building official* is permitted to
7 require that every request for *special inspection* be filed at least one working day before the
8 *special inspection* is desired. The request shall be made in writing or by telephone at the
9 option of the *building official*.

10 **1704.2.4.3 Posting special inspection record.** The *building official* is permitted to require
11 that work requiring *special inspection* not be commenced until the permit holder or the
12 permit holder's agent posts an inspection log in a conspicuous place on the premises. The
13 record shall be posted in a position which allows the *special inspector* to conveniently enter
14 his/her identification, the date, and type of inspection performed. This record shall be
15 maintained there by the permit holder until final approval has been granted by the *building*
16 *official*.

17 **1704.2.5 Special inspection of fabricated items.** Where fabrication of structural, load-bearing
18 or lateral load-resisting members or assemblies is being conducted on the premises of a
19 fabricator's shop, *special inspections* of the *fabricated items* shall be performed during
20 fabrication.

21 **Exceptions:**

22 ~~((1. *Special inspections* during fabrication are not required where the fabricator~~
23 ~~maintains *approved* detailed fabrication and quality control procedures that~~

1 provide a basis for control of the workmanship and the fabricator's ability to
2 conform to ~~approved construction documents~~ and this code. Approval shall be
3 based upon review of fabrication and quality control procedures and periodic
4 inspection of fabrication practices by the *building official*.)

5 ((2))1. *Special inspections* are not required where the fabricator is registered and
6 approved accordance with Section 1704.2.5.1.

7 2. *Special inspections* are not required for steel members and assemblies
8 produced by fabricators that are registered in the Washington Association of
9 Building Officials (WABO) Steel Fabricator Registration Program.

10 **Note:** The City of Seattle does not register fabricators for products that are within
11 the scope of the WABO registration program.

12 **1704.2.5.1 Fabricator approval.** *Special inspections* during fabrication are not
13 required where the work is done on the premises of a fabricator registered and approved
14 according to the provisions of this chapter to perform such work without *special*
15 *inspection*. ((Approval shall be based upon review of the fabricator's written procedural
16 and quality control manuals and periodic auditing of fabrication practices by an
17 *approved agency*. At completion of fabrication, the *approved* fabricator shall submit a
18 *certificate of compliance* to the owner or the owner's authorized agent for submittal to
19 the *building official* as specified in Section 1704.5 stating that the work was performed
20 in accordance with the ~~approved construction documents~~.)

21 **1704.2.5.1.1 Application for registration.** Application for registration as an
22 *approved* fabricator shall be made to the *building official* by plants engaged in the
23 manufacture of:

1 1. Prestressed or precast concrete structural products, and premixed concrete.

2 2. Unit masonry products.

3 3. Engineered wood products.

4 4. Prefabricated or assembly-line-produced metal products.

5 5. Other prefabricated products as the *building official* designates.

6 **1704.2.5.1.2 Requirements for registration.** The *building official* is authorized to
7 examine manufacturing plants that submit applications for registration and shall issue
8 certificates of registration if the plants have complied with the following requirements:

9 1. Develop and submit a detailed fabrication procedural manual reflecting key
10 quality control procedures that will provide a basis for inspection control of the
11 fabricating process.

12 2. Have the fabricator's quality control capabilities, operation of equipment and
13 personnel as outlined in the fabrication procedural manual verified by an
14 *approved* inspection or quality control agency.

15 3. Agree to have periodic plant inspections conducted by an approved inspection or
16 quality control agency to monitor the effectiveness of the quality control program
17 and to allow unannounced audits of the plant by the *building official*.

18 4. Agree to require the inspection or quality control agency to notify the *building*
19 *official* in writing of any changes to the procedural manual.

20 5. Agree to submit a Certificate of Compliance, if required by the *building official*,
21 that work was performed in accordance with the *approved* plans and
22 specifications to the *building official* and to the *registered design professional* in
23 *responsible charge*.

1 6. Pay a registration fee determined by the *building official* in accordance with
2 provisions of the Fee Subtitle.

3 **1704.2.5.1.3 Review by the building official for denial of registration of fabricators.**

4 The fabricator may request in writing a review before the *building official* to reconsider the
5 decision to deny registration. The request shall be filed in writing with the *building official*.

6 **1704.2.5.1.3.1 Review procedure.** The review shall occur no later than 15 working days
7 from receipt of the written request unless otherwise agreed by the person requesting the
8 review. Any person affected by the decision to deny registration may submit additional
9 information to the *building official* for consideration as part of the review at any time
10 prior to the review. The review will be made by a representative of the *building official*
11 who will review all additional information received. The reviewer may request
12 clarification of the information and a site visit.

13 **1704.2.5.1.3.2 Decision.** After the review, the *building official* shall:

- 14 1. Sustain the denial of registration;
15 2. Withdraw the denial of registration;
16 3. Modify the decision to deny registration; or
17 4. Continue the review to a date certain.

18 **1704.2.5.1.3.3 Order.** The *building official* shall issue an order within ten days after the
19 review is completed and shall send it by regular first class mail to the person or persons
20 requesting the review and any other person who requested a copy.

21 **1704.2.5.1.4 Renewal of registration.** Registration of *approved* fabricators is valid for one
22 year from the date of issuance and is subject to renewal annually. Registration may be
23 renewed upon application, contingent on compliance with quality control procedures

1 during the past year and payment of a fee in accordance with provisions of the Fee Subtitle.

2 The *building official* is authorized to revoke registration for cause.

3 **1704.2.5.1.5 Fees.** Fees for examination and registration of *special inspectors* are

4 determined by the *building official* in accordance with the Fee Subtitle.

5 ***

6 **1704.3.1 Content of statement of special inspections.** The statement of *special inspections*
7 shall identify the following:

- 8 1. The materials, systems, components and work required to have *special inspections* or
9 tests by the *building official* or by *the registered design professional* responsible for each
10 portion of the work.
- 11 2. The type and extent of each *special inspection*, if required by the *building official*.
- 12 3. The type and extent of each test, if required by the *building official*.
- 13 4. Additional requirements for *special inspections* or tests for seismic or wind resistance as
14 specified in Sections 1705.11, 1705.12 and 1705.13.
- 15 5. For each type of *special inspection*, identification as to whether it will be continuous
16 *special inspection*, *periodic special inspection* or performed in accordance with the
17 notation used in the referenced standard where the inspections are defined.

18 ***

19 ~~((1704.4 Contractor responsibility. Each contractor responsible for the construction of a main
20 wind or seismic force-resisting system, designated seismic system or a wind or seismic force-
21 resisting component listed in the statement of *special inspections* shall submit a written statement
22 of responsibility to the building official and the owner or the owner's authorized agent prior to
23 the commencement of work on the system or component. The contractor's statement of~~

1 responsibility shall contain acknowledgement of awareness of the special requirements contained
2 in the statement of *special inspections*.)

3 ***

4 **1704.6 Structural observations.** Where required by the provisions of Section 1704.6.1 or
5 1704.6.2, the owner or the owner's authorized agent shall employ a *registered design*
6 *professional* to perform structural observations. Structural observation does not include or waive
7 the responsibility for the inspections in Section ((110)) 108 or the *special inspections* in Section
8 1705 or other sections of this code.

9 Prior to the commencement of observations, the structural observer shall submit to the *building*
10 *official* a written statement identifying the frequency and extent of structural observations.

11 At the conclusion of the work included in the permit, the structural observer shall submit to the
12 *building official* a written statement that the site visits have been made and identify any reported
13 deficiencies that, to the best of the structural observer's knowledge, have not been resolved.

14 **1704.6.1 Structural observations for seismic resistance.** Structural observations shall be
15 provided for those structures assigned to *Seismic Design Category* D, E or F where one or
16 more of the following conditions exist:

- 17 1. The structure is classified as *Risk Category* III or IV.
- 18 2. The height of the structure is greater than 75 feet (22 860 mm) above the base as
19 defined in ASCE 7.
- 20 3. The structure is assigned to *Seismic Design Category* E, is classified as *Risk Category* I
21 or II, and is greater than two *stories above grade plane*.
- 22 4. When so designated by the *registered design professional* responsible for the structural
23 design.

4. Concrete mixes containing alternative materials addressed in Section 1705.3.2; or

5. Other unusual circumstances as determined by the *building official*.

Exception: Inspection during the mixing of concrete is not required if the proportions of ingredients are established in accordance with Table 1905.1.10 or if a mix has been granted continuous approval by the *building official*.

**TABLE 1705.3
 REQUIRED SPECIAL INSPECTIONS AND TESTS OF CONCRETE CONSTRUCTION**

| TYPE | CONTINUOUS SPECIAL INSPECTION | PERIODIC SPECIAL INSPECTION | REFERENCED STANDARD ^a | IBC REFERENCE STANDARD |
|--|-------------------------------|-----------------------------|---|--------------------------------|
| 1. Inspect reinforcement, including prestressing tendons, and verify placement. | — | X | ACI 318 Ch. 20, 25.2, 25.3, 26.5.1-26.5.3 | 1908.4 |
| 2. Reinforcing bar welding: a. Verify weldability of reinforcing bars other than ASTM A 706; b. Inspect single-pass fillet welds, maximum 5/16"; and c. Inspect all other welds. | X | X | AWS D1.4 ACI 318: 26.5.4 | — |
| 3. Inspect anchors cast in concrete. | — | X | ACI 318: 17.8.2 | — |
| 4. Inspect anchors post-installed in hardened concrete members. ^b a. Adhesive anchors installed in horizontally or upwardly inclined orientations to resist sustained tension loads. b. Mechanical anchors and adhesive anchors not defined in 4.a. | X | X | ACI 318: 17.8.2.4 ACI 318: 17.8.2 | — |
| 5. Verify use of required design mix. | — | X | ACI 318: Ch. 19, 26.4.3, 26.4.4 | 1904.1, 1904.2, 1908.2, 1908.3 |
| 6. Prior to concrete placement, fabricate specimens for strength tests, perform slump and air content tests, | X | — | ASTM C 172 ASTM C 31 ACI 318: 26.4.5, 26.12 | 1908.10 |

| | | | | |
|--|--------|--------|--|------------------------|
| and determine the temperature of the concrete. | | | | |
| 7. Inspect concrete and shotcrete placement for proper application techniques. | X | — | ACI 318: 26.4.5 | 1908.6, 1908.7, 1908.8 |
| 8. Verify maintenance of specified curing temperature and techniques. | — | X | ACI 318:26.4.7 - 26.4.9 | 1908.9 |
| 9. Inspect prestressed concrete for: a. Application of prestressing forces; and b. Grouting of bonded prestressing tendons. | X X | — — | ACI 318: 26.9.2.1 ACI 318: 26.9.2.3 | — |
| 10. Inspect erection of precast concrete members. | — | X | ACI 318: Ch. 26.8 | — |
| 11. Verify in-situ concrete strength, prior to stressing of tendons in post-tensioned concrete and prior to removal of shores and forms from beams and structural slabs. | — | X | ACI 318: 26.10.2 | — |
| 12. Inspect formwork for <u>general conformity to approved plans for size and shape, (location and dimensions)</u> of the concrete member being formed. | — | X | ACI 318: 26.10.1(b) | — |

For SI: 1 inch = 25.4 mm.

- a. Where applicable, see also Section 1705.12, *Special inspections* for seismic resistance.
- b. Specific requirements for *special inspection* shall be included in the research report for the anchor issued by an approved source in accordance with 17.8.2 in ACI 318, or other qualification procedures. Where specific requirements are not provided, *special inspection* requirements shall be specified by the *registered design professional* and shall be *approved* by the *building official* prior to the commencement of the work.

1705.12.2 Structural wood. For the seismic force-resisting systems of structures assigned to *Seismic Design Category C, D, E or F*:

1. *Continuous special inspection* shall be required during field gluing operations of elements of the seismic force-resisting system.

1 2. *Periodic special inspection* shall be required for nailing, bolting, anchoring and
2 other fastening of elements of the seismic force-resisting system, including wood
3 shear walls, wood diaphragms, drag struts, braces, shear panels and hold-downs.

4 **Exceptions:**

5 1. *Special inspections* are not required for wood shear walls, shear panels and
6 diaphragms, including nailing, bolting, anchoring and other fastening to other
7 elements of the seismic force-resisting system other than adhesive-grouted anchor
8 bolts, where the fastener spacing of the sheathing is more than 4 inches (102 mm)
9 on center.

10 2. *Special inspection* is not required for Group R-3 structures for other than
11 structural insulated panels used as shear walls.

12 3. *Special inspection* is not required in Group R-1 and R-2 structures three stories
13 and less in height for other than structural insulated panels used as shear walls.

14 4. *Special inspection* is not required for adhesive-grouted anchor bolts in Group R-1
15 and R-2 buildings if wood shear-wall fastener spacing is 4 inches (102 mm) or
16 more on center (o.c.) and hold down capacities are less than 5,000 pounds (22.2
17 kN).

18 ***

19 [BF] 1705.14.3 **Application.** The substrate shall have a minimum ambient temperature before
20 and after application as specified in the written instructions of *approved* manufacturers. ((The
21 ~~area for application shall be ventilated during and after application as required by the written~~
22 ~~instructions of approved manufacturers.))~~

23 ***

1 ~~((1705.16 Exterior insulation and finish systems (EIFS). Special inspections shall be~~
2 ~~required for all EIFS applications.~~

3 **Exceptions:**

4 1. ~~Special inspections shall not be required for EIFS applications installed over a~~
5 ~~water resistive barrier with a means of draining moisture to the exterior.~~

6 2. ~~Special inspections shall not be required for EIFS applications installed over~~
7 ~~masonry or concrete walls.~~

8 ~~1705.16.1 Water resistive barrier coating. A water resistive barrier coating complying with~~
9 ~~ASTM E 2570 requires special inspection of the water resistive barrier coating when installed~~
10 ~~over a sheathing substrate.))~~

11 ***

12 **[F] 1705.18 Testing for smoke control.** Smoke control systems shall be inspected and tested
13 according to standards specified by the building official (~~tested by a special inspector~~).

14 ~~(([F] 1705.18.1 Testing scope. The test scope shall be as follows:~~

15 1. ~~During erection of ductwork and prior to concealment for the purposes of leakage~~
16 ~~testing and recording of device location.~~

17 2. ~~Prior to occupancy and after sufficient completion for the purposes of pressure~~
18 ~~difference testing, flow measurements and detection and control verification.~~

19 ~~[F] 1705.18.2 Qualifications. Approved agencies for smoke control testing shall have~~
20 ~~expertise in fire protection engineering, mechanical engineering and certification as air~~
21 ~~balancers.))~~

22 ***

1
2
3
4
5
6
7
8
9
10
11
12
13
14
15
16
17
18
19
20
21
22
23

SECTION 1707

ALTERNATIVE TEST PROCEDURE

1707.1 General. In the absence of *approved* rules or other *approved* standards, the *building official* shall make, or cause to be made, the necessary tests and investigations; or the *building official* shall accept duly authenticated reports from *approved agencies* in respect to the quality and manner of use of new materials or assemblies as provided for in Section ((104.11)) 104.4 or 104.5. The cost of all tests and other investigations required under the provisions of this code shall be borne by the owner or the owner's authorized agent.

SECTION 1709

PRECONSTRUCTION LOAD TESTS

1709.5 Exterior window and door assemblies. The design pressure rating of exterior windows and doors in buildings shall be determined in accordance with Section 1709.5.1 or 1709.5.2. For the purposes of this section, the required design pressure shall be determined using the allowable stress design load combinations of Section 1605.3.

Exceptions:

1. Structural wind load design pressures for window units smaller than the size tested in accordance with Section 1709.5.1 or 1709.5.2 shall be permitted to be higher than the design value of the tested unit provided such higher pressures are determined by accepted engineering analysis. All components of the small unit shall be the same as the tested unit. Where such calculated design pressures are used, they shall be validated by an additional test of the window unit having the highest allowable design pressure.

1 [W] 2. Custom exterior windows and doors manufactured by small business are exempt
2 from all testing requirements in Section 1709 if they meet the applicable provisions of
3 Chapter 24.

4 ***

5 Section 17. The following sections of Chapter 18 of the International Building Code,
6 2015 Edition, are amended as follows:

7 **CHAPTER 18**

8 **SOILS AND FOUNDATIONS**

9 **SECTION 1801**

10 **GENERAL**

11 ***

12 **1801.2 Design basis.** Allowable bearing pressures, allowable stresses and design formulas
13 provided in this chapter shall be used with the *allowable stress design* load combinations
14 specified in Section 1605.3. The quality and design of materials used structurally in excavations
15 and foundations shall comply with the requirements specified in Chapters 16, 19, 21, 22 and 23
16 of this code. Excavations, ~~((and))~~ fills and land-disturbing activity shall also comply with
17 Chapter 33, the Seattle Stormwater Code (*Seattle Municipal Code* Chapter 22.800), the Seattle
18 Grading Code (*Seattle Municipal Code* Chapter 22.170), and the Regulations for
19 Environmentally Critical Areas (*Seattle Municipal Code* Chapter 25.09) and any rules adopted
20 and conditions imposed under any of them.

21 ***

22 **SECTION 1803**

23 **GEOTECHNICAL INVESTIGATIONS**

1 **1803.1 General.** Geotechnical investigations shall be conducted in accordance with Section
2 1803.2 and reported in accordance with Section 1803.6. Where ~~((required by the building official~~
3 ~~or where))~~ geotechnical investigations involve in-situ testing, laboratory testing or engineering
4 calculations, such investigations shall be conducted by a *registered design professional*.

5 ***

6 **1803.5.4 Ground-water table.** A subsurface soil investigation shall be performed to
7 determine whether the existing static ground-water table is above or within 5 feet (1524 mm)
8 below the elevation of the lowest floor level where such floor is located below the finished
9 ground level adjacent to the foundation.

10 **Exception:** A subsurface soil investigation to determine the location of the ground-water
11 table shall not be required where waterproofing is provided in accordance with Section
12 1805.

13 ***

14 **1803.5.6 Rock strata.** Where subsurface explorations at the project site indicate variations in
15 the structure of rock upon which foundations are to be constructed, the building official is
16 permitted to require a sufficient number of borings ~~((shall))~~ to be drilled to sufficient depths
17 to assess the competency of the rock and its load-bearing capacity.

18 ***

19 ~~((1803.5.10 Alternate setback and clearance. Where setbacks or clearances other than~~
20 ~~those required in Section 1808.7 are desired, the building official shall be permitted to~~
21 ~~require a geotechnical investigation by a registered design professional to demonstrate~~
22 ~~that the intent of Section 1808.7 would be satisfied. Such an investigation shall include~~

1 ~~consideration of material, height of slope, slope gradient, load intensity and erosion~~
2 ~~characteristics of slope material.))~~

3 **1803.5.11 Seismic Design Categories C through F.** For structures assigned to *Seismic*
4 *Design Category C, D, E or F, and where the structure is located in an area known to be a*
5 *geologic hazard area as defined in the Regulations for Environmentally Critical Areas*
6 *(Seattle Municipal Code Chapter 25.09)*, a geotechnical investigation shall be conducted,
7 and shall include an evaluation of all of the following potential geologic and seismic
8 hazards:

- 9 1. Slope instability.
- 10 2. Liquefaction.
- 11 3. Total and differential settlement.
- 12 4. Surface displacement due to faulting or seismically induced lateral spreading or
13 lateral flow.

14 **Exception:** The *building official* is permitted to waive this evaluation upon receipt
15 of the written opinion of a geotechnical engineer that the building's foundation
16 design adequately addresses liquefaction.

17 **1803.5.11.1 Slope instability.** The potential for slope instability shall be evaluated for
18 the design earthquake ground motion specified in Chapter 16 and Section 11.4.5 of
19 ASCE 7. Peak ground acceleration is also permitted to be determined based on a site-
20 specific study taking into account soil amplification effects. If a pseudostatic stability
21 analysis is performed, the seismic coefficient shall correspond to some fraction of the
22 anticipated peak ground acceleration.

1 **1803.5.12 Seismic Design Categories D through F.** For structures assigned to *Seismic*
2 *Design Category D, E or F, and where the structure is located in an area known to be a*
3 *geologic hazard area as defined in the Regulations for Environmentally Critical Areas*
4 *(Seattle Municipal Code Chapter 25.09), or where basement or retaining walls in geologic*
5 *hazard areas exceed 12 feet (3658 mm) in height,* the geotechnical investigation required
6 by Section 1803.5.11 shall also include all of the following as applicable:

- 7 1. The determination of dynamic seismic lateral earth pressures on foundation walls
8 and retaining walls supporting more than 6 feet (1.83 m) of backfill height due to
9 design earthquake ground motions.
- 10 2. The potential for liquefaction and soil strength loss evaluated for site peak ground
11 acceleration, earth- quake magnitude and source characteristics consistent with the
12 maximum considered earthquake ground motions. Peak ground acceleration shall be
13 determined based on one of the following:
 - 14 2.1. A site-specific study in accordance with Section 21.5 of ASCE 7.
 - 15 2.2. In accordance with Section 11.8.3 of ASCE 7.
- 16 3. An assessment of potential consequences of liquefaction and soil strength loss including,
17 but not limited to, the following:
 - 18 3.1. Estimation of total and differential settlement.
 - 19 3.2. Lateral soil movement.
 - 20 3.3. Lateral soil loads on foundations.
 - 21 3.4. Reduction in foundation soil-bearing capacity and lateral soil reaction.
 - 22 3.5. Soil downdrag and reduction in axial and lateral soil reaction for pile
23 foundations.

1 3.6. Increases in soil lateral pressures on retaining walls.

2 3.7. Flotation of buried structures.

3 4. Discussion of mitigation measures such as, but not limited to, the following:

4 4.1. Selection of appropriate foundation type and depths.

5 4.2. Selection of appropriate structural systems to accommodate anticipated
6 displacements and forces.

7 4.3. Ground stabilization.

8 4.4. Any combination of these measures and how they shall be considered in the
9 design of the structure.

10 **1803.6 Reporting.** Where geotechnical investigations are required, a written report of the
11 investigations shall be submitted to the *building official* by the permit applicant at the time of
12 permit application. This geotechnical report shall include, but need not be limited to, the
13 following information:

14 1. A plot showing the location of the soil investigations.

15 2. A complete record of the soil boring and penetration test logs and soil samples.

16 3. A record of the soil profile.

17 4. Elevation of the water table, if encountered.

18 5. Recommendations for foundation type and design criteria, including but not limited to:

19 bearing capacity of natural or compacted soil; provisions to mitigate the effects of
20 expansive soils; mitigation of the effects of liquefaction, differential settlement and varying
21 soil strength; mitigation of the effects of slope instability; and the effects of adjacent loads.

22 6. Expected total and differential settlement.

23 7. Deep foundation information in accordance with Section 1803.5.5.

1 8. Special design and construction provisions for foundations of structures founded on
2 expansive soils, as necessary.

3 9. Compacted fill material properties and testing in accordance with Section 1803.5.8.

4 10. Controlled low-strength material properties and testing in accordance with Section
5 1803.5.9.

6 ***

7 **SECTION 1805**

8 **DAMPPROOFING AND WATERPROOFING**

9 ***

10 **1805.4.3 Drainage discharge.** The floor base and foundation perimeter drain shall discharge
11 by gravity or mechanical means into an *approved* drainage system that complies with the
12 *International Plumbing Code*.

13 ((~~Exception: Where a site is located in well-drained gravel or sand/gravel mixture~~
14 ~~soils, a dedicated drainage system is not required.~~))

15 ***

16 **SECTION 1808**

17 **FOUNDATIONS**

18 ***

19 ((~~1808.7 Foundations on or adjacent to slopes.~~ The placement of buildings and structures on
20 or adjacent to slopes steeper than one unit vertical in three units horizontal (33.3 percent slope)
21 shall comply with Sections 1808.7.1 through 1808.7.5.

22 **1808.7.1 Building clearance from ascending slopes.** In general, buildings below slopes
23 shall be set a sufficient distance from the slope to provide protection from slope drainage;

1 erosion and shallow failures. Except as provided in Section 1808.7.5 and Figure
2 1808.7.1, the following criteria will be assumed to provide this protection. Where the
3 existing slope is steeper than one unit vertical in one unit horizontal (100 percent slope),
4 the toe of the slope shall be assumed to be at the intersection of a horizontal plane drawn
5 from the top of the foundation and a plane drawn tangent to the slope at an angle of 45
6 degrees (0.79 rad) to the horizontal. Where a retaining wall is constructed at the toe of
7 the slope, the height of the slope shall be measured from the top of the wall to the top of
8 the slope.

9 **1808.7.2 Foundation setback from descending slope surface.** Foundations on or
10 adjacent to slope surfaces shall be founded in firm material with an embedment and set
11 back from the slope surface sufficient to provide vertical and lateral support for the
12 foundation without detrimental settlement. Except as provided for in Section 1808.7.5
13 and Figure 1808.7.1, the following setback is deemed adequate to meet the criteria.
14 Where the slope is steeper than 1 unit vertical in 1 unit horizontal (100 percent slope), the
15 required setback shall be measured from an imaginary plane 45 degrees (0.79 rad) to the
16 horizontal, projected upward from the toe of the slope.

17 **1808.7.3 Pools.** The setback between pools regulated by this code and slopes shall be
18 equal to one-half the building footing setback distance required by this section. That
19 portion of the pool wall within a horizontal distance of 7 feet (2134 mm) from the top of
20 the slope shall be capable of supporting the water in the pool without soil support.

21 **1808.7.4 Foundation elevation.** On graded sites, the top of any exterior foundation
22 shall extend above the elevation of the street gutter at point of discharge or the inlet of
23 an *approved* drainage device a minimum of 12 inches (305 mm) plus 2 percent.

1 ~~Alternate elevations are permitted subject to the approval of the *building official*,~~
2 ~~provided it can be demonstrated that required drainage to the point of discharge and~~
3 ~~away from the structure is provided at all locations on the site.~~

4 ~~**1808.7.5 Alternate setback and clearance.** Alternate setbacks and clearances are~~
5 ~~permitted, subject to the approval of the *building official*. The *building official* shall be~~
6 ~~permitted to require a geotechnical investigation as set forth in Section 1803.5.10.))~~

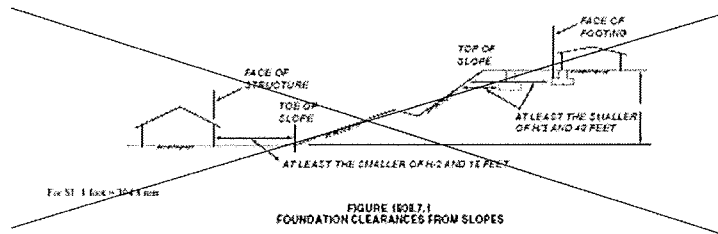

11 ***

12 SECTION 1811

13 METHANE REDUCTION MEASURES

14 **1811.1 Applicability.** This section applies to all construction activities on or within 1,000 feet
15 (305 m) of an active, closed or abandoned landfill (landfill zone) that has been identified by the
16 *building official* to be generating levels of methane gas on-site at the lower explosive limits or
17 greater levels. The distance shall be calculated from the location of the proposed structure to
18 the nearest property line of the active or former landfill site. The *building official* is permitted
19 to waive these requirements if technical studies demonstrate that dangerous amounts of
20 methane are not present on the location of the proposed structure.

21 **1811.2 Protection of Structures.** All enclosed structures to be built within the 1,000 foot (305
22 m) landfill zone shall be protected from potential methane migration. The method for
23 protecting a structure from methane shall be identified in a report prepared by a licensed civil

1 engineer and submitted by the applicant to the *building official* for approval. The report shall
2 contain a description of the investigation and recommendations for preventing the
3 accumulation of explosive concentrations of methane gas within or under enclosed portions of
4 the building or structure. At the time of final inspection, the civil engineer shall furnish a
5 signed statement attesting that, to the best of the engineer's knowledge, the building or
6 structure has been constructed in accordance with the recommendations for addressing
7 methane gas migration.

8 Section 18. The following sections of Chapter 19 of the International Building Code,
9 2015 Edition, are amended as follows:

10 **CHAPTER 19**

11 **CONCRETE**

12 ***

13 **SECTION 1904**

14 **DURABILITY REQUIREMENTS**

15 ***

16 **1904.2 Nonstructural concrete.** The registered design professional shall assign nonstructural
17 concrete a freeze-thaw exposure class, as defined in ACI 318, based on the anticipated exposure
18 of nonstructural concrete. Nonstructural concrete shall have a minimum specified compressive
19 strength, f'_c , of 2,500 psi (17.2 MPa) for Class F0; 3,000 psi (20.7 MPa) for Class F1; and 3,500
20 psi (24.1 MPa) for Classes F2 and F3. Nonstructural concrete shall be air entrained in accordance
21 with ACI 318.

22 **Code Alternate CA1904.2:** Five-sack 2000 psi (13.8 MPa) and five 1/2-sack 2500 psi (17.2
23 MPa) concrete mixes shall be deemed to comply with the requirements for 3000 psi (20.7 MPa)

1 concrete in Sections 1904.1 and 1904.2. Air-entrainment is not required for durability
2 purposes. Mixes shall be proportioned to produce a 5-inch or less slump, with a maximum
3 allowable tolerance of 1-inch plus.

4 SECTION 1905

5 MODIFICATIONS TO ACI 318

6 **1905.1 General.** The text of ACI 318 shall be modified as indicated in Sections 1905.1.1 through
7 ~~((1905.1.8))~~ 1905.1.10.

8 ***

9 **1905.1.9 ACI 318, Section 5.1.1.** Modify ACI 318, Section 5.1.1, to read as follows:

10 5.1.1 – Concrete shall be proportioned to provide an average compressive strength, f'_c , as
11 prescribed in 5.3.2 and shall satisfy the durability criteria of Chapter 4. Concrete shall be
12 produced to minimize the frequency of strength tests below f'_c , as prescribed in 5.6.3.3. For
13 concrete designed and constructed in accordance with the Code, f'_c shall not be less than
14 2500 psi.

15 **Exception:** Concrete is permitted to be designed and constructed in accordance with
16 Section 1905.1.2.

17 **1905.1.10 ACI 318, Section 5.2.** Modify ACI 318, Section 5.2 by adding new Section 5.2.4
18 as follows:

19 Concrete proportioning in accordance with Table 1905.1.10 is permitted to be used for
20 concrete to be made with cements meeting strength requirements for Type I, II, or III of
21 ASTM C 150. Table 1905.1.10 shall not be used to proportion concrete containing
22 lightweight aggregates. If *approved by the building official*, Table 1905.1.10 is permitted to
23 be used with air-entraining admixtures (conforming to ASTM C260) and/or normal-range

1 water-reducing admixtures (conforming to ASTM C494-11 Standard Specification for
2 Chemical Admixtures for Concrete, Types A, D or E; or C618-12 Standard Specification for
3 Coal Fly Ash and Raw or Calcined Natural Pozzolan for Use in Concrete). For strengths
4 greater than 4000 psi (27.7 MPa), proportions shall be established on the basis of field
5 experience and trial mixtures according to ACI Section 5.3 or by proportioning without field
6 mixtures or trial mixtures according to ACI Section 5.4. When *approved* by the *building*
7 *official*, concrete proportions shall be determined in accordance with the provisions of ACI
8 318, Section 5.3. or 5.4.

| <u>SPECIFIED 28-DAY</u> <u>COMPRESSIVE</u> <u>STRENGTH IN psi</u> <u>(<i>f'_{cc}</i>)</u> | <u>MINIMUM</u> <u>PERMISSIBLE</u> <u>CEMENT</u> <u>CONTENT IN</u> <u>lb/cu yd</u> | <u>MINIMUM</u> <u>PERMISSIBLE</u> <u>CEMENT CONTENT</u> <u>IN STD. 94-lb</u> <u>SACKS/cu yd</u> |
|--|--|--|
| <u>2000</u> | <u>423</u> | <u>4 1/2¹</u> |
| <u>2500</u> | <u>470</u> | <u>5¹</u> |
| <u>3000</u> | <u>517</u> | <u>5 1/2</u> |
| <u>4000²</u> | <u>611</u> | <u>6 1/2</u> |

1. Where *special inspection* is not required under Section 1705, the minimum permissible cement content shall be increased by 1/2 sack per cubic yard of concrete.

2. For strengths above 4000 psi, see Section 1905.1.10.

9
10 ***

11 Section 19. The following sections of Chapter 21 of the International Building Code,
12 2015 Edition, are amended as follows:

13 **CHAPTER 21**

14 **MASONRY**

15 ***

1
2
3
4
5
6
7
8
9
10
11
12
13
14
15
16
17
18
19
20
21
22
23

SECTION 2107

ALLOWABLE STRESS DESIGN

2107.2 TMS 402/ACI 530/ASCE 5, Section 8.1.6.7.1.1, lap splices. As an alternative to Section 8.1.6.7.1.1, it shall be permitted to design lap splices in accordance with Section 2107.2.1.

[W]2107.2.1 Lap splices. The minimum length of lap splices for reinforcing bars in tension or compression, l_d , shall be

$l_d = 0.002d_b f_s$ **(Equation 21-1)**

For SI: $l_d = 0.29d_b f_s$

but not less than 12 inches (305 mm). In no case shall the length of the lapped splice be less than 40 bar diameters.

where:

d_b = Diameter of reinforcement, inches (mm).

f_s = Computed stress in reinforcement due to design loads, psi (MPa).

In regions of moment where the design tensile stresses in the reinforcement are greater than 80 percent of the allowable steel tension stress, F_s , the lap length of splices shall be increased not less than 50 percent of the minimum required length but need not be greater than $72d_b$.

Other equivalent means of stress transfer to accomplish the same 50 percent increase shall be permitted. Where epoxy coated bars are used, lap length shall be increased by 50 percent.

SECTION 2111

MASONRY FIREPLACES

1 **[W] 2111.8 Fireplaces.** Fireplaces shall be provided with each of the following:

2 1. Tightly fitting flue dampers, operated by a readily accessible manual or *approved* automatic
3 control.

4 **Exception:** Fireplaces with gas logs shall be installed in accordance with *International*
5 *Mechanical Code* Section 901, except that the standards for liquefied petroleum gas
6 installations shall be NFPA 58 (*Liquefied Petroleum Gas Code*) and NFPA 54 (*National Fuel*
7 *Gas Code*).

8 2. An outside source for combustion air ducted into the firebox. The duct shall be at least 6
9 square inches and shall be provided with an operable outside air duct damper.

10 **Exception:** Washington certified fireplaces shall be installed with the combustion air
11 systems necessary for their safe and efficient combustion and specified by the manufacturer
12 in accordance with Section 2114.

13 3. Site built fireplaces shall have tight fitting glass or metal doors, or a flue draft induction fan
14 or as *approved* for minimizing back-drafting. Factory built fireplaces shall use doors listed
15 for the installed appliance.

16 **2111.8.1 Lintel and throat.** Masonry over a fireplace opening shall be supported by a lintel of
17 noncombustible material. The minimum required bearing length on each end of the fireplace
18 opening shall be 4 inches (102 mm). The fireplace throat or damper shall be located not less
19 than 8 inches (203 mm) above the top of the fireplace opening.

20 **2111.8.((4))2 Damper.** Masonry fireplaces shall be equipped with a ferrous metal damper located
21 not less than 8 inches (203 mm) above the top of the fireplace opening. Dampers shall be
22 installed in the fireplace or at the top of the flue venting the fireplace, and shall be operable from

1 the room containing the fireplace. Damper controls shall be permitted to be located in the
2 fireplace.

3 ***

4 **SECTION 2114**

5 **EMISSION STANDARDS**

6 **[W] 2114.1 Emission standards for factory-built fireplaces.** New and used factory-built
7 fireplaces shall be certified and labeled in accordance with procedures and criteria specified in
8 ASTM E2558 Standard Test Method for Determining Particulate Matter Emission from Fires in
9 Low Mass Wood-burning Fireplaces.

10 To certify an entire fireplace model line, the internal assembly shall be tested to determine its
11 particulate matter emission performance. Retesting and recertifying is required if the design and
12 construction specifications of the fireplace model line internal assembly change. Testing for
13 certification shall be performed by a Washington State Department of Ecology (DOE) approved
14 and U. S. Environmental Protection Agency (EPA) accredited laboratory.

15 **2114.2 Emission standards for certified masonry and concrete fireplaces.** Masonry and
16 concrete fireplace model lines certified to Washington State Building Code Standard 31-2 prior
17 to July 1, 2013 may retain certification if the design and construction specifications of the
18 fireplace model line internal assembly do not change.

19 Section 20. The following sections of Chapter 23 of the International Building Code,
20 2015 Edition, are amended as follows:

21 **CHAPTER 23**

22 **WOOD**

23 ***

SECTION 2303

MINIMUM STANDARDS AND QUALITY

2303.4.1.2 Permanent individual truss member restraint. Where permanent restraint of truss members is required on the truss design drawings, it shall be accomplished by one of the following methods:

1. Permanent individual truss member restraint/bracing shall be installed using standard industry lateral restraint/bracing details in accordance with generally accepted engineering practice. Locations for lateral restraint shall be identified on the truss design drawing.
2. The trusses shall be designed so that the buckling of any individual truss member is resisted internally by the individual truss through suitable means (i.e., buckling reinforcement by T-reinforcement or L-reinforcement, proprietary reinforcement, etc.). The buckling reinforcement of individual members of the trusses shall be installed as shown on the truss design drawing or on supplemental truss member buckling reinforcement details provided by the truss designer.
3. A project-specific permanent individual truss member restraint/bracing design shall be permitted to be specified by any qualified registered design professional.

2303.4.6 TPI 1 specifications. In addition to Sections 2303.4.1 through 2303.4.5, the design, manufacture and quality assurance of metal-plate-connected wood trusses shall be in accordance with TPI 1. Job-site inspections shall be in compliance with Section ~~((110.4))~~ 108, as applicable.

1 Section 21. The following sections of Chapter 24 of the International Building Code,
2 2015 Edition, are amended as follows:

3 **CHAPTER 24**

4 **GLASS AND GLAZING**

5 ***

6 **SECTION 2407**

7 **GLASS IN HANDRAILS AND GUARDS**

8 **2407.1 Materials.** Glass used in a handrail, guardrail or a guard section shall be laminated glass
9 constructed of fully tempered or heat-strengthened glass and shall comply with Category II or
10 CPSC 16 CFR Part 1201 or Class A of ANSI Z97.1. Glazing in railing in-fill panels shall be of
11 an approved safety glazing material that conforms to the provisions of Section 2406.1.1. For all
12 glazing types, the minimum nominal thickness shall be 1/4 inch (6.4 mm).

13 **Exception:** Single fully tempered glass complying with Category II of CPSC 16 CFR Part
14 1201 or Class A of ANSI Z97.1 shall be permitted to be used in handrails and guardrails
15 where there is no walking surface beneath them or the walking surface is permanently
16 protected from the risk of falling glass.

17 **[W] 2407.1.1 Loads.** The panels and their support system shall be designed to withstand the
18 loads specified in Section 1607.8, using a factor of safety of four. ~~((A design factor of four
19 shall be used for safety.))~~

20 **[W]** ~~((**2407.1.2 Support.** Each handrail or guard section shall be supported by a minimum of
21 three glass balusters or shall be otherwise supported to remain in place should one baluster
22 panel fail. Glass balusters shall not be installed without an attached handrail or guard.))~~

1 **[W] 2407.1.2 Structural glass baluster panels.** Guards with structural glass baluster panels
2 shall be installed with an attached top rail or handrail. The top rail or handrail shall be
3 supported by a minimum of three glass baluster panels, or shall be otherwise supported to
4 remain in place should one glass baluster panel fail.

5 **Exception:** An attached top rail or handrail shall not be required where the glass baluster
6 panels are laminated glass with two or more glass plies of equal thickness and of the
7 same glass type ~~((when approved by the building official. The panels shall be designed to~~
8 ~~withstand the loads specified in Section 1607.8)).~~

9 ***

10 SECTION 2409

11 GLASS IN WALKWAYS, ELEVATOR HOISTWAYS AND ELEVATOR CARS

12 **2409.1 Glass walkways.** Glass installed as ~~((a part of a floor/ceiling assembly as))~~ a walking
13 surface shall comply with Chapter 16. ~~((and constructed with laminated))~~

14 **Exception:** Laminated glass ~~((shall comply))~~ designed in accordance with ASTM E 2751 is
15 not required to comply with Chapter 16. ~~((or with the load requirements specified in Chapter~~
16 ~~16.))~~

17 Such assemblies shall comply with the *fire-resistance rating* requirements of this code where
18 applicable.

19 ***

20 Section 22. The following sections of Chapter 25 of the International Building Code,
21 2015 Edition, are amended as follows:

22 ***

23 CHAPTER 25

1 **GYPSUM BOARD, GYPSUM PANEL PRODUCTS AND PLASTER**

2 ***

3 **SECTION 2503**

4 **INSPECTION**

5 **2503.1 Inspection.** Lath, gypsum board and gypsum panel products shall be inspected in
6 accordance with Section ((110.3.5)) 108.9.

7
8 ***

9 Section 23. The following sections of Chapter 27 of the International Building Code,
10 2015 Edition, are amended as follows:

11 **CHAPTER 27**

12 **ELECTRICAL**

13 **SECTION 2701**

14 **GENERAL**

15 **2701.1 Scope.** This chapter governs the electrical components, equipment and systems used in
16 buildings and structures covered by this code. Electrical components, equipment and systems
17 shall be designed and constructed in accordance with the provisions of ((NFPA-70)) the Seattle
18 Electrical Code.

19 **SECTION 2702**

20 **EMERGENCY AND LEGALLY REQUIRED STANDBY POWER SYSTEMS**

21 **[F] 2702.1 Installation.** Emergency power systems and legally required standby power systems
22 shall comply with Sections 2702.1.1 through 2702.1.7.

1 [F] 2702.1.1 **Stationary generators.** Stationary emergency and legally required standby
2 power generators required by this code shall be *listed* in accordance with UL 2200.

3 [F] 2702.1.2 **Electrical.** Emergency power systems and legally required standby power
4 systems required by this code or the *International Fire Code* shall be installed in accordance
5 with the *International Fire Code*, ((NFPA-70)) the *Seattle Electrical Code*, NFPA 110 and
6 NFPA 111.

7 **Exceptions:**

- 8 1. Where located within a sprinklered parking garage of Type I or II construction,
9 emergency power and legally required standby power systems with fixed fuel
10 quantities meeting the limits of Section 603.3 of the *International Fire Code*, and
11 their transfer switches, are not required to be in a separate room. Other
12 occupancies located in the story where the system is located shall be separated
13 from the system by fire barriers with a minimum 1 hour fire-resistance rating.
- 14 2. Combustion and radiator intake air are permitted to be transferred from the
15 adjacent garage. Radiator discharge air is permitted to be transferred to the
16 adjacent garage. Radiator ventilation intake and discharge air locations shall be
17 separated to maintain the radiator ventilation intake air temperature below the
18 maximum temperature allowed to meet the emergency and legally required
19 standby power system loads.

20 [F] 2702.1.3 **Load transfer.** Emergency power systems shall automatically provide
21 secondary power within 10 seconds after primary power is lost, unless specified otherwise in
22 this code. ((Standby)) Legally required standby power systems shall automatically provide

1 secondary power within 60 seconds after primary power is lost, unless specified otherwise in
2 this code.

3 **[F] 2702.1.4 Load duration.** Emergency power systems and legally required standby power
4 systems shall be designed to provide the required power for a minimum duration of 8 hours
5 for fire pumps in accordance with NFPA 20, and 2 hours for other systems without being
6 refueled or recharged, unless specified otherwise in this code.

7 **[F] 2702.1.5 Uninterruptable power source.** An uninterrupted source of power shall be
8 provided for equipment when required by the manufacturer's instructions, the listing, this
9 code or applicable referenced standards.

10 **[F] 2702.1.6 Interchangeability.** Emergency power systems shall be an acceptable
11 alternative for installations that require standby power systems.

12 **[F] 2702.1.7 Group I-2 occupancies.** In Group I-2 occupancies, in new construction or
13 where the building is substantially damaged, where an essential electrical system is located in
14 flood hazard areas established in Section 1612.3, the system shall be located and installed in
15 accordance with ASCE 24.

16 **[F] 2702.2 Where required.** Emergency and legally required standby power systems shall be
17 provided where required by Sections 2702.2.1 through 2702.2.16 and other sections of this code.

18 **[F] 2702.2.1 Emergency alarm systems.** Emergency power shall be provided for emergency
19 alarm systems as required by Section 415.5.

20 **[F] 2702.2.2 Elevators and platform lifts.** ((Standby)) Legally required standby power shall
21 be provided for elevators and platform lifts used as accessible means of egress as required in
22 Sections 1009.4 ((,)) and 1009.5((, 3003.1, 3007.8 and 3008.8)). Emergency power shall be
23 provided for elevators in high-rise buildings as required in Section 403.4.8.4.

1 [F] 2702.2.3 **Emergency responder radio coverage systems.** Emergency power shall be
2 provided for emergency responder radio coverage systems in high-rise buildings as required
3 in Section 403.4.8.4. ((Standby)) Legally required standby power shall be provided for other
4 emergency responder radio coverage systems as required in ((Section 916 and)) the
5 *International Fire Code.* ((The standby power supply shall be capable of operating the
6 emergency responder radio coverage system for a duration of not less than 24 hours.))

7 [F] 2702.2.4 **Emergency voice/alarm communication systems.** Emergency power shall be
8 provided for emergency voice/alarm communication systems as required in Section
9 907.5.2.2.5. The system shall be capable of powering the required load for a duration of not
10 less than 24 hours, as required in NFPA 72.

11 [F] 2702.2.5 **Exit signs.** Emergency power shall be provided for exit signs as required in
12 Section 1013.6.3. The system shall be capable of powering the required load for a duration of
13 not less than 90 minutes.

14 [F] 2702.2.6 **Group I-2 occupancies.** Essential electrical systems for Group I-2 occupancies
15 shall be in accordance with Section 407.10.

16 [F] 2702.2.7 **Group I-3 occupancies.** Emergency power shall be provided for power-
17 operated doors and locks in Group I-3 occupancies as required in Section 408.4.2.

18 [F] 2702.2.8 **Hazardous materials.** Emergency or legally required standby power shall be
19 provided in occupancies with hazardous materials where required by the *International Fire*
20 *Code.*

21 [F] 2702.2.9 **High-rise buildings.** Emergency ((and standby)) power shall be provided in
22 high-rise buildings as required in Sections 403.4.8.

1 [F] **2702.2.10 Horizontal sliding doors.** ((Standby)) Legally required standby power shall
2 be provided for horizontal sliding doors as required in Section 1010.1.4.3. The standby
3 power supply shall have a capacity to operate not fewer than 50 closing cycles of the door.

4 [F] **2702.2.11 Means of egress illumination.** Emergency power shall be provided for means
5 of egress illumination as required in Section 1008.3. The system shall be capable of powering
6 the required load for a duration of not less than 90 minutes.

7 [F] **2702.2.12 Membrane structures.** ((Standby)) Legally required standby power shall be
8 provided for auxiliary inflation systems in permanent membrane structures as required in
9 Section 3102.8.2. ((Standby)) Legally required standby power shall be provided for a
10 duration of not less than 4 hours. Auxiliary inflation systems in temporary air-supported and
11 air-inflated membrane structures shall be provided in accordance with Section 3103.10.4 of
12 the *International Fire Code*.

13 [F] **2702.2.13 Pyrophoric materials.** Emergency power shall be provided for occupancies
14 with silane gas in accordance with the *International Fire Code*.

15 [F] **2702.2.14 Semiconductor fabrication facilities.** Emergency power shall be provided for
16 semiconductor fabrication facilities as required in Section 415.11.10.

17 [F] **2702.2.15 Smoke control systems.** ((Standby)) Emergency power shall be provided for
18 smoke control systems as required in Sections 404.7, 909.11, 909.20.5.7, 909.20.6.2 and
19 909.21.5. Legally required standby power systems shall be provided for pressurization
20 systems in low-rise buildings in accordance with Sections 909.20.6 and 909.21.5.

21 [F] **2702.2.16 Underground buildings.** Emergency ((and standby)) power shall be provided
22 in underground buildings as required in Section 405.

1 **[F] 2702.3 Critical circuits.** Cables used for survivability of required critical circuits shall be
2 listed in accordance with UL 2196. Electrical circuit protective systems shall be installed in
3 accordance with their listing requirements.

4 **[F] 2702.4 Maintenance.** Emergency and standby power systems shall be maintained and tested
5 in accordance with the *International Fire Code*.

6 Section 24. The following sections of Chapter 29 of the International Building Code,
7 2015 Edition, are amended as follows:

8 **CHAPTER 29**

9 **PLUMBING SYSTEMS**

10 **SECTION 2901**

11 **GENERAL**

12 **[P] 2901.1 Scope.** The provisions of this chapter and the ~~((*International*))~~ *Uniform Plumbing*
13 *Code* shall govern the erection, installation, alteration, repairs, relocation, replacement, addition
14 to, use or maintenance of plumbing equipment and systems. Toilet and bathing rooms shall be
15 constructed in accordance with Section 1210. Plumbing systems and equipment shall be
16 constructed, installed and maintained in accordance with the ~~((*International*))~~ *Uniform Plumbing*
17 *Code*. ~~((Private sewage disposal systems shall conform to the *International Private Sewage*~~
18 ~~*Disposal Code*))~~

19 **2901.2 Enforcement.** The Director of Public Health–Seattle and King County is authorized to
20 enforce this chapter.

21 **[W] 2901.3 Health codes.** In food preparation, serving and related storage areas, additional
22 fixture requirements may be dictated by state and local health codes.

23 **SECTION 2902**

MINIMUM PLUMBING FACILITIES

[W] [P] 2902.1 Minimum number of fixtures. Plumbing fixtures shall be provided in the minimum number as shown in Table 2902.1 (~~(based on the actual use of the building or space)~~).

Uses not shown in Table 2902.1 shall be (~~(considered)~~) determined individually by the (~~(code)~~) building official based on the occupancy which most nearly resembles the proposed occupancy.

The number of occupants shall be determined by this code. Plumbing fixtures need not be provided for unoccupied buildings or facilities.

[P] 2902.1.1 Fixture calculations. To determine the occupant load of each sex, the total occupant load shall be divided in half. To determine the required number of fixtures, the fixture ratio or ratios for each fixture type shall be applied to the occupant load of each sex in accordance with Table 2902.1. Fractional numbers resulting from applying the fixture ratios of Table 2902.1 shall be rounded up to the next whole number. For calculations involving multiple occupancies, such fractional numbers for each occupancy shall first be summed and then rounded up to the next whole number.

Exception: The total occupant load shall not be required to be divided in half where approved statistical data indicate a distribution of the sexes of other than 50 percent of each sex.

[W] 2902.1.1.1 Private offices. Fixtures only accessible to private offices shall not be counted to determine compliance with this section.

[W] 2902.1.1.2 Urinals. Where urinals are provided, one water closet less than the number specified may be provided for each urinal installed, except the number of water closets in such cases shall not be reduced to less than 25 percent of the minimum specified.

1 **[P]2902.1.2 Family or assisted-use toilet and bath fixtures.** Fixtures located within family or
2 assisted-use toilet and bathing rooms required by Section 1109.2.1 are permitted to be included
3 in the number of required fixtures for either the male or female occupants in assembly and
4 mercantile occupancies.

**[W] [P] TABLE 2902.1
MINIMUM NUMBER OF REQUIRED PLUMBING FIXTURES^a
(See Sections 2902.1.1 and 2902.2)**

| No. | CLASSIFICATION | OCCUPANCY | DESCRIPTION | WATER CLOSETS ((URINALS SEE SECTION 419.2 OF THE INTERNATIONAL PLUMBING CODE)) | | LAVATORIES | | BATHTUBS/ SHOWERS | ((DRINKING FOUNTAINS (SEE SECTION 410 OF THE INTERNATIONAL PLUMBING CODE)) | OTHER)) |
|-----|---|--|--|--|---|---|---------------|---|--|--------------------------------|
| | | | | Male | Female | Male | Female | | | |
| 1 | Assembly | A-1 ^d | Theaters and other buildings for the performing arts and motion pictures | 1 per 125 | 1 per 65 | 1 per 200 | | — | ((1 per 500 | 1 service sink)) |
| | | A-2 ^d | Nightclubs, bars, taverns, dance halls and buildings for similar purposes | 1 per 40 | 1 per 40 | 1 per 75 | | — | ((1 per 500 | 1 service sink)) |
| | | | Restaurants, banquet halls and food courts | 1 per 75 | 1 per 75 | 1 per 200 | | — | ((1 per 500 | 1 service sink)) |
| | | A-3 ^d | Auditoriums without permanent seating, art galleries, exhibition halls, museums, lecture halls, libraries, arcades and gymnasiums | 1 per 125 | 1 per 65 | 1 per 200 | | — | ((1 per 500 | 1 service sink)) |
| | | | Passenger terminals and transportation facilities | 1 per 500 | 1 per 500 | 1 per 750 | | — | ((1 per 1,000 | 1 service sink)) |
| | | | Places of worship and other religious services | 1 per 150 | 1 per 75 | 1 per 200 | | — | ((1 per 1,000 | 1 service sink)) |
| | | A-4 | Coliseums, arenas, skating rinks, pools and tennis courts for indoor sporting events and activities | 1 per 75 for the first 1,500 and 1 per 120 for the remainder exceeding 1,500 | 1 per 40 for the first 1,520 and 1 per 60 for the remainder exceeding 1,520 | 1 per 200 | 1 per 150 | — | ((1 per 1,000 | 1 service sink)) |
| A-5 | Stadiums, amusement parks, bleachers and grandstands for outdoor sporting events and activities | 1 per 75 for the first 1,500 and 1 per 120 for the remainder exceeding 1,500 | 1 per 40 for the first 1,520 and 1 per 60 for the remainder exceeding 1,520 | 1 per 200 | 1 per 150 | — | ((1 per 1,000 | 1 service sink)) | | |
| 2 | Business | B | Buildings for the transaction of business, professional services, other services involving merchandise, office buildings, banks, light industrial and similar uses | 1 per 25 for the first 50 and 1 per 50 for the remainder exceeding 50 | | 1 per 40 for the first 80 and 1 per 80 for the remainder exceeding 80 | | — | ((1 per 100 | 1 service sink ^e)) |
| 3 | Educational | E | Educational facilities | 1 per 35 ((50)) | 1 per 25 | 1 per 85 | 1 per 50 | — | ((1 per 100 | 1 service sink)) |
| 4 | Factory and industrial | F-1 and F-2 | Structures in which occupants are engaged in work fabricating, assembly or processing of products or materials | 1 per 100 | | 1 per 100 | | See ((Section 411 of the International Plumbing Code)) footnote f | ((1 per 400 | 1 service sink)) |
| 5 | Institutional | I-1 | Residential care | 1 per 10 | | 1 per 10 | | 1 per 8 | ((1 per 100 | 1 service sink)) |
| | | I-2 | Hospitals, ambulatory nursing home care recipient ^b | 1 per room ^c | | 1 per room ^c | | 1 per 15 | ((1 per 100 | 1 service sink)) |

**[W] [P] TABLE 2902.1
MINIMUM NUMBER OF REQUIRED PLUMBING FIXTURES^a
(See Sections 2902.1.1 and 2902.2)**

| No. | CLASSIFICATION | OCCUPANCY | DESCRIPTION | WATER CLOSETS ((URINALS SEE SECTION 419.2 OF THE INTERNATIONAL PLUMBING CODE)) | | LAVATORIES | | BATHTUBS/ SHOWERS | (DRINKING FOUNTAINS (SEE SECTION 410 OF THE INTERNATIONAL PLUMBING CODE) | OTHER)) |
|-----|----------------|------------|--|--|--------|---------------------|--------|---|--|---|
| | | | | Male | Female | Male | Female | | | |
| | | | Employees, other than residential care ^b | 1 per 25 | | 1 per 35 | | — | ((1 per 100 | —)) |
| | | | Visitors, other than residential care | 1 per 75 | | 1 per 100 | | — | ((1 per 500 | —)) |
| | | I-3 | Prisons ^b | 1 per cell | | 1 per cell | | 1 per 15 | ((1 per 100 | 1 service sink)) |
| | | I-3 | Reformatories, detention centers and correctional centers ^b | 1 per 15 | | 1 per 15 | | 1 per 15 | ((1 per 100 | 1 service sink)) |
| | | | Employees ^b | 1 per 25 | | 1 per 35 | | — | ((1 per 100 | —)) |
| | | I-4 | Adult day care and child day care | 1 per 15 | | 1 per 15 | | 1 | ((1 per 100 | 1 service sink)) |
| 6 | Mercantile | M | Retail stores, service stations, shops, salesrooms, markets and shopping centers | 1 per 500 | | 1 per 750 | | — | ((1 per 1,000 | 1 service sink ^c)) |
| 7 | Residential | R-1 | Hotels, motels, boarding houses (transient) | 1 per sleeping unit | | 1 per sleeping unit | | 1 per sleeping unit | ((— | 1 service sink)) |
| | | R-2 | Dormitories, fraternities, sororities and boarding houses (not transient) | 1 per 10 | | 1 per 10 | | 1 per 8 | ((1 per 100 | 1 service sink)) |
| | | R-2 | Apartment house | 1 per dwelling unit | | 1 per dwelling unit | | 1 per dwelling unit | ((— | 1 kitchen sink per dwelling unit; 1 automatic clothes washer connection per 20 dwelling units)) |
| | | R-3 | One- and two-family dwellings and lodging houses with five or fewer guest rooms | 1 per dwelling unit | | 1 per 10 | | 1 per dwelling unit | ((— | 1 kitchen sink per dwelling unit; 1 automatic clothes washer connection per dwelling unit)) |
| | | R-3 | Congregate living facilities with 16 or fewer persons | 1 per 10 | | 1 per 10 | | 1 per 8 | ((1 per 100 | 1 service sink)) |
| | | ((R-4 | Congregate living facilities with 16 or fewer persons | 1 per 10 | | 1 per 10 | | 1 per 8 | 1 per 100 | 1 service sink)) |
| 8 | Storage | S-1 S-2 | Structures for the storage of goods, warehouses, storehouses and freight depots, low and moderate hazard | 1 per 100 | | 1 per 100 | | See ((Section 411 of the International Plumbing | ((1 per 1,000 | 1 service sink)) |

**[W] [P] TABLE 2902.1
 MINIMUM NUMBER OF REQUIRED PLUMBING FIXTURES^a
 (See Sections 2902.1.1 and 2902.2)**

| No. | CLASSIFICATION | OCCUPANCY | DESCRIPTION | WATER CLOSETS ((URINALS SEE SECTION 419.2 OF THE INTERNATIONAL PLUMBING CODE)) | | LAVATORIES | | BATHTUBS/ SHOWERS | ((DRINKING FOUNTAINS (SEE SECTION 410 OF THE INTERNATIONAL PLUMBING CODE) | OTHER)) |
|--|----------------|-----------|-------------|--|--------|------------|--------|------------------------------|---|---------|
| | | | | Male | Female | Male | Female | | | |
| | | | | | | | | <i>Code)) footnote f</i> | | |
| <p>a. The fixtures shown are based on one fixture being the minimum required for the number of persons indicated or any fraction of the number of persons indicated. The number of occupants shall be determined by this code, except with respect to Group E occupancies the provisions of note "e" shall apply.</p> <p>b. Toilet facilities for employees shall be separate from facilities for inmates or care recipients.</p> <p>c. A single-occupant toilet room with one water closet and one lavatory serving not more than two adjacent patient <i>sleeping units</i> shall be permitted, provided that each patient <i>sleeping unit</i> has direct access to the toilet room and provisions for privacy for the toilet room user are provided.</p> <p>d. The occupant load for seasonal outdoor seating and entertainment areas shall be included when determining the minimum number of facilities required.</p> <p>e. For Group E occupancies the number of occupants shall be determined by using a calculation of 100 square feet gross building area per student for the minimum number of plumbing fixtures. ((For business and mercantile occupancies with an occupant load of 15 or fewer, service sinks shall not be required.))</p> <p>f. See <i>Uniform Plumbing Code</i> Section 416.0 for installation requirements for emergency shower and eyewash equipment.</p> | | | | | | | | | | |

1
2
3

1 **[W] [P]2902.2 Separate facilities.** Where plumbing fixtures are required, separate facilities shall
2 be provided for each sex.

3 **Exceptions:**

- 4 1. Separate facilities shall not be required for dwelling units and sleeping units.
- 5 2. Separate facilities shall not be required in structures or tenant spaces with a total occupant
6 load, including both employees and customers, of 15 or fewer.
- 7 3. Separate facilities shall not be required in mercantile occupancies in which the maximum
8 occupant load is 100 or less.
- 9 4. Separate facilities shall not be required in spaces primarily used for drinking or dining
10 with a total occupant load, including both employees and customers, of 30 or fewer.
- 11 5. Single-occupant restrooms shall not be restricted to a specific sex or gender identity and
12 shall use appropriate signage to indicate such facilities are designated for use by any
13 person, regardless of sex or gender identity. See SMC 14.07.

14 **[P]2902.2.1 Family or assisted-use toilet facilities serving as separate facilities.** Where a
15 building or tenant space requires a separate toilet facility for each sex and each toilet facility is
16 required to have only one water closet, two family or assisted-use toilet facilities shall be
17 permitted to serve as the required separate facilities. Family or assisted-use toilet facilities shall
18 not be required to be identified for exclusive use by either sex as required by Section 2902.4.

19 **[P]2902.3 Employee and public toilet facilities.** Customers, patrons and visitors shall be
20 provided with public toilet facilities in structures and tenant spaces intended for public
21 utilization. The number of plumbing fixtures located within the required toilet facilities shall be
22 provided in accordance with Section 2902.1 for all users. Employees shall be provided with toilet

1 facilities in all occupancies. Employee toilet facilities shall be either separate or combined
2 employee and public toilet facilities.

3 **Exception:** Public toilet facilities shall not be required in:

- 4 1. Open or enclosed parking garages where there are no parking attendants.
- 5 2. Structures and tenant spaces intended for quick transactions, including takeout,
6 pickup and drop-off, having a public access area less than or equal to 300 square feet
7 (28 m²).

8 **[W] [P] 2902.3.1 Access.** The route to the public toilet facilities required by Section 2902.3
9 shall not pass through kitchens, food preparation areas, unpackaged food storage areas, storage
10 rooms or closets. Access to the required facilities shall be from within the building or from the
11 exterior of the building. Access to toilets serving multiple tenants shall be through a common
12 use area and not through an area controlled by a tenant. Routes shall comply with the
13 accessibility requirements of this code. The public shall have access to the required toilet
14 facilities at all times that the building is occupied. For other requirements for plumbing
15 facilities, see Chapter 11.

16 **[W] [P] 2902.3.2 Location of toilet facilities in occupancies other than malls.** In
17 occupancies other than covered and open mall buildings, the required public and employee
18 toilet facilities shall be located in each building not more than one story above or below the
19 space required to be provided with toilet facilities, or conveniently in a building adjacent
20 thereto on the same property, and the path of travel to such facilities shall not exceed a distance
21 of 500 feet (152 m).

1 **Exception:** The location and maximum distances of travel to required employee facilities in
2 factory and industrial occupancies are permitted to exceed that required by this section,
3 provided that the location and maximum distance of travel are approved.

4 ***

5 **[W] [P] 2902.5 Drinking fountain location.** Drinking fountains shall not be required to be
6 located in individual tenant spaces provided that public drinking fountains are located within a
7 distance of travel of 500 feet (152 m) of the most remote location in the tenant space and not
8 more than one story above or below the tenant space. Where the tenant space is in a covered or
9 open mall, such distance shall not exceed 300 feet (91 440 mm). Drinking fountains shall be
10 located on an accessible route. Drinking fountains shall not be located in toilet rooms.

11 **[W] 2902.5.1 Drinking fountain number.** Occupant loads over 30 shall have one drinking
12 fountain for the first 150 occupants, then one per each additional 500 occupants.

13 **Exceptions:**

- 14 1. Sporting facilities with concessions serving drinks shall have one drinking
15 fountain for each 1,000 occupants.
- 16 2. A drinking fountain need not be provided in a drinking or dining establishment.

17 **[W] 2902.5.2 Multistory buildings.** Drinking fountains shall be provided on each floor
18 having more than 30 occupants in schools, dormitories, auditoriums, theaters, offices and
19 public buildings.

20 **[W] 2902.5.3 Penal institutions.** Penal institutions shall have one drinking fountain on each
21 cell block floor and one on each exercise floor.

22 **[W] 2902.5.4 Bottle filling stations.** Bottle filling stations shall be provided in accordance
23 with Sections 2902.5.4.1 through 2902.5.4.3.

1 **2902.5.4.1 Group E occupancies.** In Group E occupancies with an occupant load over
2 30, a minimum of one bottle filling station shall be provided on each floor. This bottle
3 filling station may be integral to a drinking fountain.

4 **2902.5.4.2 Substitution.** In all occupancies that require more than two drinking fountains
5 per floor or secured area, bottle filling stations shall be permitted to be substituted for up
6 to 50 percent of the required number of drinking fountains.

7 **2902.5.4.3 Accessibility.** At least one of the required bottle filling stations shall be
8 located in accordance with Section 309 of ICC A117.1.

9 **[W] 2902.6 Dwelling units.** Dwelling units shall be provided with a kitchen sink.

10 **[W] 2902.7 Water closet space requirements.** The water closet stool in all occupancies shall be
11 located in a clear space not less than 30 inches (762 mm) in width, with a clear space in front of
12 the stool of not less than 24 inches (610 mm).

13 **[W] 2902.8 Water.** Each required sink, lavatory, bathtub and shower stall shall be equipped with
14 hot and cold running water necessary for its normal operation.

15 **[P] 2902.9 ((2902.6)) Small occupancies.** Drinking fountains shall not be required for an
16 occupant load of 15 or fewer.

17 Section 25. Chapter 30 of the Seattle Building Code is adopted to read as follows:

18 **CHAPTER 30**

19 **ELEVATORS AND CONVEYING SYSTEMS**

20 **SECTION 3001**

21 **PURPOSE**

22 The purpose of this chapter is to protect persons, buildings and the contents thereof from hazards
23 arising from the use of elevators, dumbwaiters, material lifts, escalators, moving walks and other

1 conveyances by establishing minimum requirements regulating the design, construction,
2 alteration, operation and maintenance of elevators, dumbwaiters, material lifts, escalators,
3 moving walks and other conveyances, and by establishing procedures by which these
4 requirements may be enforced.

5 SECTION 3002

6 SCOPE

7 **3002.1 General.** This code of safety standards covers the design, construction, installation,
8 operation, inspection testing, maintenance, alteration and repair of elevators, dumbwaiters,
9 material lifts, escalators, moving walks and other conveyances.

10 **3002.2 Application to existing conveyances.**

11 **3002.2.1 Minimum standard for existing conveyances.** All existing conveyances shall
12 comply with Washington Administrative Code (WAC) Chapter 296-96 Part D as it existed on
13 February 15, 2013 and with Section 3011 as minimum standards.

14 **3002.2.2 Maintenance.** All conveyances covered under this chapter, both existing and new,
15 and all parts thereof shall be maintained in a safe condition. All devices and safeguards that
16 are required by this chapter shall be maintained in good working order. All devices or
17 safeguards that were required by a code in effect when the conveyance was installed, altered,
18 or repaired shall be maintained in good working order. Maintenance shall comply with
19 ASME A17.1 Section 8.6. The owner or the owner's designated agent is responsible for the
20 maintenance of such equipment.

21 **3002.2.3 Repairs and replacements.** Repairs to existing conveyances and replacements of
22 devices and components shall be made with parts of at least equivalent material, strength and
23 design. They shall comply with WAC 296-96 Part D and ASME A17.1 Section 8.6.

1 **3002.2.4 Additions and alterations.** Additions and alterations are permitted to be made to
2 the conveyance system of existing buildings or structures without making the entire system
3 comply with all of the requirements of this chapter for new buildings or structures, provided
4 the additions and alterations that are made comply with the requirements of this chapter for a
5 new system, except as otherwise specifically provided in this code and in other applicable
6 retroactive ordinances of the city.

7 Unless otherwise *approved* by the *building official*, alterations, repairs, replacements and
8 maintenance of conveyances shall comply with the requirements of ASME A17.1 Section
9 8.7. Where Section 8.7 refers to a requirement that has been amended by this chapter, the
10 requirements of this chapter take precedence. Where Section 8.7 refers to ASME A17.3, the
11 requirements of WAC 296-96 Part D apply. Alterations to existing material lifts shall
12 conform with the requirements of WAC Chapter 296-96 Part C1 Material Lifts.

13 **3002.2.5 Seismic improvements.** The *building official* is authorized to promulgate rules to
14 establish standards for seismic improvements to existing conveyances.

15 **3002.2.6 Change of use.** When the use of an existing freight elevator is changed to carrying
16 of passengers, the elevator must comply with the retroactive requirements of this code,
17 ASME A17.1, 2.16.4 and WAC 296-96 Part D for passenger elevators.

18 **3002.2.7 Historic buildings and structures.** See the *International Existing Building Code*
19 for regulations regarding historic buildings or structures.

20 **3002.3 References to the National Electrical Code.** For the purpose of this chapter, all
21 references in the ASME Code to the National Electrical Code include the Seattle Electrical Code.
22 All electrical work shall be done in accordance with the requirements of the Seattle Electrical
23 Code.

1 **3002.4 Conflicts.** In any case where the codes adopted by reference in Section 3003 conflict
2 with the requirements of this chapter, this chapter controls.

3 **SECTION 3003**

4 **CODES**

5 **3003.1 Seattle Elevator Code.** The following are adopted by reference as part of the Seattle
6 Building Code. They also constitute the Elevator Code of the City of Seattle.

- 7 1. Safety Code for Elevators and Escalators, ASME A17.1-2013, as amended in this
8 ordinance and Appendices A through D, F through J, L, M and P through V.

9 **Exceptions:**

10 1.1. ASME A17.1 Sections 5.4, 5.5, 5.10 and 5.11 are not adopted.

11 1.2. ASME A17.1 Section 1.2.1, Purpose, is not adopted.

- 12 2. Safety Standard for Platform Lifts and Stairway Chairlifts, ASME A18.1-2011.
13 3. Standard for Elevator Suspension, Compensation, and Governor Systems, ASME A17.6-
14 2010.

15 **Exception:** ASME A17.6 Part 2 Aramid Fiber Ropes for Elevators, is not adopted.

- 16 4. Safety regulations for all elevators, dumbwaiters, escalators and other conveyances,
17 Washington Administrative Code Chapter 296-96 as it existed on February 15, 2013.

18 **Exception:** The following sections of WAC Chapter 296-96 are not part of the
19 *Elevator Code of the City of Seattle:*

- 20 1. Part B, Licenses and Fees for all Elevators, Dumbwaiters, Escalators, and
21 Other Devices.
22 2. Part B-1, Regulations and Fees for All Elevators, Dumbwaiters, Escalators
23 and Other Conveyances

3. Part C3, Construction, Operation, Maintenance and Inspection of Private Residence Conveyances for Transporting Property for Residential Use.
4. Part C4, Temporary Hoists.
5. Part C5, Additional Types of Conveyances.

3003.2 Licensing. All persons and firms working on conveyances in Seattle shall comply with chapter 70.87 RCW and chapter 296-96 WAC.

3003.3 Administrative rules. The *building official* is authorized to adopt by administrative rule, in accordance with Section 104.8, that furthers the intent and purpose of this code, that encourages the use of state of the art technology, materials or methods of construction, and which provides standards that are equal or better than those contained in this code.

SECTION 3004

DEFINITIONS

The following words and terms shall, for the purposes of this section and as used elsewhere in this code, have the meanings shown herein. These definitions are in addition to ASME A17.1 Section 1.3, RCW 70.87, Laws Governing Elevators and Other Lifting Devices, and Chapter 2 of this code.

ALTERATIONS, REPAIRS AND REPLACEMENTS. See ASME A17.1 Section 1.3.

AUTOMATIC ELEVATOR. A type of elevator that does not require an attendant. All calls are registered by the passengers.

AUTOMOBILE PARKING ELEVATOR. An elevator located in either a stationary or horizontally moving hoistway and used exclusively for parking automobiles where, during the parking process, each automobile is moved under its own power onto and off the elevator

1 directly into parking spaces or cubicles in line with the elevator and where no persons are
2 normally stationed on any level except the receiving level.

3 **CONTROL ROOM.** An enclosed control space outside the hoistway, intended for full bodily
4 entry, that contains the motor controller. The room could also contain electrical or mechanical
5 equipment used directly in connection with the elevator, dumbwaiter, or material lift but not the
6 electric driving machine or the hydraulic machine.

7 **CONTROL SPACE.** A space outside the hoistway, intended to be accessed with or without full
8 bodily entry, that contains the motor controller. This space could also contain electrical or
9 mechanical equipment used directly in connection with the elevator, dumbwaiter, or material lift
10 but not the electric driving machine or the hydraulic machine.

11 **CONVEYANCE.** An elevator, accessibility lift, escalator, dumbwaiter, material lift, automobile
12 parking elevator, moving walk or other elevating device.

13 **CONVEYANCES IN SERVICE.** Units that are in operation, are inspected and certified by the
14 *building official* for operation.

15 **CONVEYANCES OUT OF SERVICE.** The use of the unit has been prohibited either
16 temporarily or permanently in accordance with Section 3005 below.

17 **ELEVATOR GROUP.** A grouping of elevators in a building located adjacent or directly across
18 from one another that responds to common hall call buttons.

19 **ENFORCING AUTHORITY.** As used in ASME A17.1 means the *building official*.

20 **EXISTING INSTALLATIONS.** All conveyances that have been tested and approved for use
21 by the building official.

22 **INSPECTOR.** Inspectors employed by the City of Seattle and working under the direction of
23 the *building official*.

1 **MACHINE ROOM.** An enclosed machinery space outside the hoistway, intended for full
2 bodily entry, that contains the electric driving machine or the hydraulic machine. The room
3 could also contain the motor controller, and electrical and/or mechanical equipment used directly
4 in connection with the elevator, dumbwaiter, or material lift.

5 **MACHINERY SPACE.** A space inside or outside the hoistway, intended to be accessed with or
6 without full bodily entry, that contains elevator, dumbwaiter, or material lift mechanical
7 equipment, and could also contain electrical equipment used directly in connection with the
8 elevator, dumbwaiter, or material lift. This space could also contain the electric driving machine.

9 **MATERIAL LIFT.** A fixed, stationary conveyance that:

- 10 1. Has a car or platform that moves in guides;
- 11 2. Serves two or more floors or landings of a building or structure;
- 12 3. Has a vertical rise of at least 30 inches (762 mm) and no more than sixty feet (18 288
13 mm);
- 14 4. Has a maximum speed of fifty feet (15 240 mm) per minute;
- 15 5. Is an isolated, self-contained lift and is not a part of a conveying system;
- 16 6. Travels in an inclined or vertical, but not horizontal, direction;
- 17 7. Is operated only by, or under the direct supervision of, an individual designated by the
18 employer; and
- 19 8. Is installed in a commercial or industrial area, and not in an area that is open to access by
20 the general public.

21 **SECTION 3005**

22 **AUTHORITY TO DISCONNECT UTILITIES, TAKE CONVEYANCES OUT OF**
23 **SERVICE AND INVESTIGATE ACCIDENTS**

1 **3005.1 Disconnection of utilities.** In addition to the provisions for Emergency Orders provided
2 in Section 102, the *building official* is authorized to disconnect or order discontinuance of any
3 utility service or energy supply to equipment regulated by this code in cases of emergency or
4 where necessary for safety to life and property. Such utility service shall be discontinued until the
5 equipment, appliances, devices or wiring found to be defective or defectively installed are
6 replaced, repaired, or restored to a safe condition. Proper posting and seals shall be affixed to the
7 equipment to prevent inadvertent use.

8 **3005.2 Conveyances out of service.** A conveyance shall be taken out of service temporarily
9 after the *building official* has inspected the unit for proper parking of the car, securing the
10 hoistway openings, and disconnection of power. A seal and tag shall be placed on the equipment
11 to insure against unauthorized use. A conveyance is permitted to remain in a temporarily out-of-
12 service status for a period not to exceed two years, after which time it shall be placed in a
13 permanently out-of-service status.

14 **Exception:** Elevators that could be returned to service without repair are permitted to remain
15 in a temporary out-of-service status with approval of the *building official*.

16 A conveyance shall be placed permanently out of service by landing the car and
17 counterweights and removing the hoisting cables or fluid lines. Conveyances placed in a
18 permanently out-of-service status shall have the hoistway sealed off for fire protection by
19 securing existing doors.

20 Conveyances in an out-of-service status either temporarily or permanently are permitted to be
21 placed back into service and classified as an existing installation unless determined to be
22 hazardous by the *building official*. Requirements in effect at that time must be completed before

1 certification and use. No installation or reconnection of hydraulic elevators powered by city
2 water pressure is permitted.

3 **3005.3 Report and investigation of accidents.** The owner or the owner's authorized agent shall
4 promptly notify the *building official* of each accident involving a conveyance that requires the
5 service of a physician or results in a disability exceeding one day, and shall afford the *building*
6 *official* every facility for investigating and inspecting the accident. The *building official* shall
7 without delay, after being notified, make an inspection and shall place on file a full and complete
8 report of the accident. The report shall give in detail all material facts and information available
9 and the cause or causes, so far as they can be determined. The report shall be open to public
10 inspection at all reasonable hours. If an accident involves the failure or destruction of any part of
11 the construction or the operating mechanism of a conveyance, the use of the conveyance is
12 forbidden until it has been made safe, it has been reinspected and any repairs, changes, or
13 alterations have been *approved* by the department, and a permit has been issued by the *building*
14 *official*. The removal of any part of the damaged construction or operating mechanism from the
15 premises is forbidden until the *building official* grants permission to do so.

16 SECTION 3006

17 INSTALLATION AND ALTERATION PERMITS

18 **3006.1 Installation permits.** A permit issued by the *building official* is required to install any
19 elevator, escalator, dumbwaiter, automobile parking elevator, material lift moving walk,
20 accessibility lifts or other conveyance. A separate permit shall be obtained for each conveyance
21 installed regardless of location and/or contract arrangements.

22 **3006.2 Alteration/repair permits.** A permit is required to make any alterations to existing
23 elevators, escalators, dumbwaiters, automobile parking elevators, material lifts, moving walks or

1 other conveyances. A separate permit shall be obtained for each conveyance altered or relocated
2 regardless of location and/or contract arrangements.

3 **Exceptions:**

- 4 1. Permits for repairs required by inspection reports are permitted to be combined for a
5 single building.
- 6 2. The *building official* is permitted to issue a single permit for minor alterations to more
7 than one conveyance that do not require individual retesting of each conveyance.
- 8 3. No permit shall be required for ordinary repairs made with parts of the same
9 materials, strength and design normally necessary for maintenance.

10 **3006.3 Temporary use permits.** The *building official* is permitted to issue a temporary use
11 permit for a period not to exceed 60 days to allow completion of installation and passing of the
12 final inspection. Temporary use permits may be renewed by the *building official*. If, at any time
13 during the period of temporary use, the building official determines that the building owner is not
14 making adequate progress toward completion of the installation and passing of the final
15 inspection, the *building official* is permitted to withdraw the temporary use permit on 7 days'
16 notice. The *building official* is authorized to forbid further use of the conveyance until a
17 certificate of inspection is obtained. If any conveyance is found to be unsafe or fails to comply
18 with a notice of correction, the *building official* is authorized to revoke the temporary use permit.

19 **3006.4 Expiration, renewal and revocation of permits.** Sections 106.9 through 106.12 apply
20 to permits required by this chapter.

21 **SECTION 3007**

22 **PLANS AND SPECIFICATIONS**

1 **3007.1 Permit drawings.** Two sets of drawings shall be submitted with applications for
2 installations of new elevators, escalators, dumbwaiters, automobile parking elevators, material
3 lifts, moving walks and other conveyances.

4 The drawings shall show beams, attachments, loads and reactions, and shall bear the seal of a
5 structural engineer licensed under the laws of Washington State.

6 The *structural engineer in responsible charge* for the building shall review the drawings and
7 forward them to the *building official* with a notation indicating that the drawings have been
8 reviewed and been found to be in general conformance to the design of the building.

9 **Exception:** An engineer's stamp is not required for hydraulic elevators.

10 **3007.2 Amendments to the permit.** If changes to the *approved* work are made during
11 construction, approval of the *building official* shall be obtained prior to execution. The inspector
12 may approve minor changes for work that will not reduce the structural strength or fire and life
13 safety of the structure. The inspector shall determine if it is necessary to revise the *approved*
14 *construction documents*. No changes that are subject to special inspection required by Chapter
15 17 shall be made during construction unless approved by the *building official*. If revised plans
16 are required, changes shall be shown on two sets of plans that shall be submitted to and approved
17 by the *building official*, accompanied by fees specified in the Fee Subtitle prior to occupancy.
18 All changes shall conform to the requirements of this code and other pertinent laws and
19 ordinances and other issued permits.

20 SECTION 3008

21 REQUIRED INSTALLATION INSPECTIONS

22 **3008.1 Installation inspections.** It is the duty of the person doing the work authorized by a
23 permit to notify the *building official* that such work is ready for inspection.

1 It is the duty of the person requesting any inspections required by this chapter to provide
2 access to and means for proper inspection of such work.

3 Final inspection shall be called for by the applicant when the work described on the permit
4 has been completed, and when ready for testing with weights and instruments, as needed. A final
5 inspection is required after all wiring has been completed and all permanent fixtures such as
6 switches, outlet receptacles, plates, lighting fixtures and all other equipment has been properly
7 installed, and the hoistway, control rooms, machine rooms and machine spaces are properly
8 completed.

9 SECTION 3009

10 CERTIFICATES OF INSPECTION AND OPERATION

11 **3009.1 Certificates required.** It is a violation of this code to operate any elevator, escalator,
12 dumbwaiter, automobile parking elevator, material lift, moving walk or other conveyance
13 without a certificate of inspection or authorization of temporary use issued by the *building*
14 *official*. A certificate of inspection shall be issued following an inspection by the *building*
15 *official* showing that the conveyance has been found to be in safe operating condition and
16 applicable fees for inspection time, as set forth in the Fee Subtitle, have been paid. The
17 certificate is valid until 45 days after the next inspection or until the certificate is withdrawn,
18 whichever comes first.

19 If any conveyance is found to be *unsafe* or fails to comply with a notice of correction, the
20 *building official* is authorized to withdraw the certificate of inspection.

21 **3009.2 Periodic inspections.** The *building official* shall cause inspections to be made of every
22 conveyance at intervals of 12 months or as soon thereafter as is practical. The inspector shall file

1 a full and correct report on each conveyance with the *building official* that shall note any code
2 violations, corrections required and the general condition of the conveyance.

3 **3009.3 Inspection report by building official.** After each required inspection of a conveyance
4 the *building official* shall mail a copy of the inspection report to the owner of the conveyance
5 inspected. If inspection shows a conveyance to be in violation of the requirements of this chapter,
6 the *building official* shall issue a notice in writing listing the corrections to be made to the
7 conveyance that are necessary to bring it into compliance with this chapter and is authorized to
8 order the operation thereof discontinued until the corrections are made. The owner upon receipt
9 of inspection report shall complete all corrections within 90 days. The owner or owner's
10 authorized agent shall notify the *building official* in writing when deficiencies are corrected.

11 **3009.4 Inspections, tests and test reports.** Reports of required tests shall be submitted to the
12 owner and to the *building official* on forms furnished by the *building official*. Reports shall be
13 submitted to the *building official* in writing within 60 days of completion of tests. Performance
14 of required tests and their cost shall be the responsibility of the owner. Identification of
15 conveyances shall be noted by use of assigned city numbers.

16 SECTION 3010

17 REQUIREMENTS FOR OPERATION AND MAINTENANCE

18 **3010.1 Responsibility for operation and maintenance.** The owner is responsible for the safe
19 operation and maintenance of each device regulated by this chapter. The installation of pipes,
20 ducts, conduits, wiring and the storage of materials not required for the operation of the elevator
21 is prohibited in hoistways, control rooms, machine rooms and machine spaces. See Section
22 3022. Sidewalk elevators in public places are also subject to the requirements of Title 15, Seattle

1 Municipal Code, Street and Sidewalk Use, as amended. See Part 8 of ASME A17.1 for
2 requirements for operation and maintenance.

3 SECTION 3011

4 RETROACTIVE REQUIREMENTS FOR EXISTING INSTALLATIONS

5 **3011.1 General.** Existing conveyances shall be made to comply with WAC 296-96 Part D,
6 Regulations for Existing Elevators, Dumbwaiters, and Escalators and the provisions of this
7 section.

8 **3011.2 Doors to elevator and dumbwaiter machine rooms.** Doors to elevator and dumbwaiter
9 machine rooms, control rooms and machinery spaces shall be self-closing and self-locking. The
10 lock shall be a spring-type lock arranged to permit the door to be opened from the inside without
11 a key, incapable of being left in the unlocked position, and accessible only by a key from the
12 outside.

13 **3011.3 Key retainer box.** A key retainer box locked and keyed to the standard City access key
14 for elevator access and operation keys shall be provided. The key retainer box shall meet the
15 following standards:

- 16 1. Dimensions – 8 inches high, 6 inches wide, 1 inch deep.
- 17 2. Material – 16 gauge steel welded.
- 18 3. Color – red (unless located in the main lobby above the hall call button, 6 feet nominal
19 above the floor).
- 20 4. Labeling – “FOR FIRE DEPARTMENT USE.”
- 21 5. Lock – Ace one-inch cylinder cam lock key #39504.

22 The key retainer box is to be installed at the designated recall floor above the Phase I recall
23 switch or in the main lobby above the hall call button when no recall feature exists. The key

1 retainer box is to be mounted 6 feet nominal above the floor. The *building official* is permitted to
2 approve other locations upon request.

3 Key retainer boxes are permitted to comply with Section 3016.9 as an alternative to
4 complying with this section.

5 **3011.4 Elevator access keys.** Keys for access to and for the operation of elevating equipment
6 shall be tagged and retained in the key retainer box. The key retainer box shall contain fire
7 emergency service keys (Phase I and II, one key for each switch) and keys for any of the
8 following that are in the building:

- 9 1. Doors to the control room, machine room and machine space;
- 10 2. Secondary level door;
- 11 3. Pit door;
- 12 4. Roof door;
- 13 5. Independent, hospital emergency and/or attendant operation;
- 14 6. Hoistway access;
- 15 7. Mechanical hoistway access devices (broken arm, lunar, etc.);
- 16 8. Miscellaneous switches with locks;
- 17 9. Fire alarm panel room;
- 18 10. Sprinkler valve control room.

19 **3011.5 Dumbwaiter machinery access.** Access doors to dumbwaiter machinery spaces shall be
20 provided with electric contacts and labeled on the exterior side “DANGER - DUMBWAITER
21 MACHINE” in one-inch letters.

22 **3011.6 Machine space lighting and receptacles.** Permanent electric lighting shall be provided
23 in all control rooms, machine rooms and machinery spaces. The illumination shall be not less

1 than 10 foot-candles (108 lux) at the floor level. The lighting control switch shall be located
2 within easy reach of the access to the room or space. Where practicable, the light control switch
3 shall be located on the lock-jamb side of the access door. Where practical, elevator pits, control
4 rooms, machine rooms and machine spaces shall be provided with an electrical receptacle.

5 **3011.7 Access to terminal landings.** Mechanical access to terminal landings of elevator
6 hoistways shall be provided in accordance with WAC 296-96-23162 (1).

7 **3011.8 Wall covering material for passenger cars.** All materials exposed to the car interior and
8 the hoistway shall be metal or shall conform to the following:

9 (1) Materials in their end use configuration, other than those covered by paragraph (2) below,
10 shall conform to the following requirements, based on the tests conducted in accordance
11 with the requirements of ASTM E 84, ANSI/UL 723 or NFPA 252:

12 (a) flame spread rating of 0 to 75;

13 (b) smoke development of 0 to 450.

14 (2) Napped, tufted, wove, looped, and similar materials in their end use configuration on car
15 enclosure walls shall have a flame spread rating of 0 to 25.

16 (3) Padded protective linings, for temporary use in passenger cars during the handling of
17 freight, shall be of materials conforming to either paragraph (1) or (2) above. The
18 protective lining shall clear the floor by not less than 4 inches (102 mm).

19 (4) Floor covering, underlayment, and its adhesive shall have a critical radiant flux of not
20 less than 0.45 W/cm^2 as measured by ASTM E 648. Floor finish materials of a traditional
21 type such as wood, vinyl, linoleum and terrazzo are permitted to be used.

1 **Exception:** Handrails, operating devices, ventilating devices, signal fixtures, audio and
2 visual communication devices, and their housings are not required to comply with this
3 Section 3011.8.

4 **3011.9 Control and operating circuits and overcurrent protection.** Overcurrent protection
5 shall be maintained in accordance with *1984 National Electrical Code* Section 620-61.

6 **3011.9.1 Control and operating circuits.**

7 **3011.9.1.1 Electric elevators.**

- 8 1. For electric elevators, the normal and final terminal stopping device shall not control
9 the same controller switches unless two or more separate and independent switches
10 are provided, two of which shall be closed to complete the driving-machine motor-
11 and-brake circuit in either direction of travel. Where a two- or three-phase alternating
12 current driving-machine motor is used, these switches shall be of the multipole type.

13 The control shall be so designed and installed that a single ground or short circuit
14 may permit either, but not prevent both, the normal and final stopping device circuits
15 from stopping the car.

- 16 2. In the design and installation of the control and operating circuits in electric elevators,
17 the following requirements shall be met:

18 a. If springs are used to actuate switches, contactors or relays to break the circuit
19 to stop an elevator at the terminal landings, they shall be of the compression
20 type.

21 b. The completion or maintenance of an electric circuit shall not be used to
22 interrupt the power to the elevator driving-machine motor or brake at the

1 terminal landings, nor to stop the car when the emergency stop switch is
2 opened or any of the electrical protective devices operate.

3 **Exception:** The requirements of this rule do not apply to dynamic braking,
4 nor to speed control switches.

5 c. The failure of any single magnetically operated switch, contactor or relay to
6 release in the intended manner, or the failure of any static control device to
7 operate as intended, or the occurrence of a single accidental ground, shall not
8 permit the car to start or run if any hoistway door interlock is unlocked or if
9 any hoistway door or car door or gate electric contact is not in the closed
10 position.

11 d. If generator-field control is used, means shall be provided to prevent the
12 generator from building up and applying sufficient current to the elevator
13 driving-machine motor to move the car if the elevator motor control switches
14 are in the "OFF" position. The means used shall not interfere with
15 maintenance of an effective dynamic-braking circuit during stopping and
16 standstill conditions.

17 e. The control circuits shall be so designed and installed that the car speed in the
18 down direction with rated load in the car, under normal operating conditions
19 with the power supply on or off does not exceed governor tripping speed or
20 125 percent of rated speed, whichever is less.

21 3. Elevators with driving motors employing static control without motor generator sets
22 shall conform to the following requirements:

- 1 a. Two devices shall be provided to remove power independently from the
2 driving-machine motor. At least one device shall be an electromechanical
3 contactor.
- 4 b. The contactor shall be arranged to open each time the car stops.
- 5 c. The contactor shall open the driving-machine brake circuit.
- 6 d. An additional contactor shall be provided to also open the driving-machine
7 brake circuit. This contactor is not required to have contacts in the driving-
8 machine motor circuit.
- 9 e. The electrical protective devices required by Rule 210.2 of ASME A17.1d-
10 1986 shall control the solid state device and both contactors.

11 **Exception:** Leveling can take place with power opening of doors and
12 gates as restricted by the requirements of Rules 112.2a(1) and 112.2b(1) of
13 ASME A17.1d-1986.

- 14 f. After each elevator stop, the car shall not respond to a signal to start unless
15 both contactors are in the de-energized position.

16 **Exception:** Elevators employing alternating-current hoist motors driven
17 from a direct-current source through a static inverter.

- 18 4. Elevators employing alternating-current driving motors driven from a direct-current
19 power source through a static inverter shall conform to the following requirements:
 - 20 a. Two separate means shall be provided to independently inhibit the flow of
21 alternating current through the solid state devices that connect the direct-
22 current power source to the alternating-current driving motor. At least one of
23 the means shall be an electromechanical relay.

- 1 b. The relay shall be arranged to open each time the car stops.
- 2 c. The relay shall cause the driving-machine brake circuit to open.
- 3 d. An additional contactor shall be provided to also open the driving-machine
- 4 brake circuit. This contactor is not required to have contacts in the driving-
- 5 machine motor circuit.
- 6 e. The electrical protective devices required by Rule 210.2 of ASME A17.1d-
- 7 1986 shall control both the means that inhibit the flow of alternating current
- 8 through the solid state devices and the contactors in the brake circuit.

9 **Exception:** Leveling can take place with power opening of the doors and

10 gates as restricted by the requirements of Rules 112.2a(1) and 112.2b(1) of

11 ASME A17.1d-1986.

- 12 f. After each elevator stop, the car shall not respond to a signal to start unless the
- 13 relay that inhibits the flow of alternating current through the solid state
- 14 devices, and the contactors in the brake circuit, are in the de-energized
- 15 position.

16 **3011.9.1.2 Hydraulic elevators.** The design and installation of the control and operating

17 circuits for hydraulic elevators shall conform to the following requirements:

- 18 a. Springs, where used to actuate switches, contactors or relays to stop an elevator at the
- 19 terminals or to actuate electrically operated valves, shall be of the compression type.
- 20 b. The completion or maintenance of an electric circuit shall not be used to interrupt the
- 21 power to control-valve-operating magnets nor to the pump driving motor of electro-
- 22 hydraulic elevators under the following conditions:

- 23 1. To stop the car at the terminals.

1 2. To stop the car when the emergency-stop switch or any of the electrical
2 protective devices operate.

3 c. The failure of any single magnetically operated switch, contactor or relay to release in
4 the intended manner or the occurrence of a single accidental ground shall not permit
5 the car to start or run if any hoistway door interlock is unlocked or if any hoistway-
6 door or car-door or gate contact is not in the closed position.

7 **3011.10 Roped hydraulic elevators.** Roped horizontal hydraulic elevators are permitted to
8 continue in service but once taken out of service shall not be reactivated.

9 **3011.11 Pit Access and equipment.** Access ladders shall be installed in elevator pits deeper
10 than 3 feet.

11 Pits shall be illuminated by a permanent luminaire that provides not less than 5 foot-candles
12 (54 lux) of illumination at the pit floor. Light bulbs shall be externally guarded to prevent
13 contact and accidental breakage.

14 Pit light control switches shall be located inside the hoistway of every elevator approximately
15 48 inches above the threshold, and either within 18 inches of the access door or within reach
16 from the access floor and adjacent to the pit ladder if provided.

17 Access shall be provided for safe maintenance and inspection of all equipment located in the
18 pit.

19 **3011.12 Floor numbers.** Elevator hoistways shall have floor numbers not less than 2 inches in
20 height, placed on the walls and/or doors of hoistways at intervals such that a person in a stalled
21 elevator upon opening the car door could determine the floor position.

22 **3011.13 Car top work light.** A permanently wired work light and outlet shall be installed on top
23 of freight and passenger elevators to provide adequate illumination for inspection and work in

1 the hoistway. The light shall be provided with a non-keyed switch in or adjacent to the fixture.
2 The fixture shall be protected from accidental breakage.

3 **3011.14 Labeling.** All equipment (disconnect switches, machines and controllers) operating on a
4 voltage in excess of 250 volts shall be labeled for the voltage used in letters 3/4 inches high.

5 **3011.15 Interior alterations.** Alterations or modifications of elevator car interiors shall comply
6 with ASME A17.1, 8.7.2.15.2 (increase or decrease in deadweight of car), Building Code
7 requirements concerning flame spread ratings for wall coverings (See Chapter 8), and lighting
8 requirements of ASME A17.1.

9 **3011.16 Illumination.** Illumination in the elevator car shall be maintained unless it is turned off
10 manually by the switch in the car. A readily-accessible and labeled toggle-type test switch shall
11 be provided on the top of the car to cut lighting power manually and test the emergency lighting.

12 **3011.17 Conveyance number designation.** In any building with more than one elevator,
13 escalator or other type of conveyance a designating number (not less than two inches in height)
14 shall be located at the door of the main entrance lobby, inside the car, on the machine, on the
15 disconnect switch or stop switch, and on escalator upper and lower front plates.

16 **3011.18 Escalator starting switches.** "Up" and "Down" positions shall be clearly indicated on
17 all starting switches.

18 **3011.19 Anchorage for elevator equipment.** All elevator equipment, hydraulic or cable type
19 shall be anchored.

20 **3011.20 Restricted opening of doors.** All existing passenger elevators in Group R-1 hotels and
21 dormitory buildings shall comply with the following.

- 1 1. When a car is outside the unlocking zone, the hoistway doors or car doors shall be so
2 arranged that the hoistway doors or car doors cannot be opened more than 4 inches (102
3 mm) from inside the car.
- 4 2. When the car doors are so arranged that they cannot be opened when the car is outside
5 the unlocking zone, the car doors shall be openable from outside the car without the use
6 of special tools.
- 7 3. The doors shall be unlocked when the car is within 3 inches (76 mm) above or below the
8 landing and are permitted to be configured to be unlocked up to 18 inches (457 mm)
9 above or below the landing.

10 **SECTION 3012**

11 **RETROACTIVE REQUIREMENTS FOR EXISTING MATERIAL LIFTS**

12 **3012.1 General.** Existing material lifts shall be made to comply with the following requirements.

13 (Note: New material lifts shall comply with Section 3013).

14 **3012.2 Hoistway enclosure gates and doors.** The openings at each material lift landing shall
15 have gates or doors that guard the full width of the opening. A hoistway door shall be vertically
16 sliding, bi-parting, counter-balanced, or horizontally swinging or sliding. Gates and doors shall
17 meet the following requirements:

- 18 1. A balanced-type, vertically sliding hoistway gate shall extend from not more than 2
19 inches from the landing threshold to not less than 66 inches above the landing threshold.
- 20 2. A gate shall be solid or openwork of a design that will reject a ball 2 inches in diameter. A
21 gate shall be located so that the distance from the hoistway face of the gate to the
22 hoistway edge of the landing sill is not more than 2 ½ inches. A gate shall be designed
23 and guided so that it will withstand a lateral pressure of one hundred pounds applied at

1 approximately its center without breaking or being permanently deformed and without
2 displacing the gate from its guides or tracks.

- 3 3. Hoistway gates or doors shall have a combination mechanical lock and electric contact,
4 which shall prevent operation of the material lift by the normal operating devices unless
5 the door or gate is closed.

6 **3012.3 Controls.**

7 1. The control station shall be remotely mounted so that it is inaccessible from the material
8 lift car.

9 2. Controls shall be clearly marked or labeled to indicate the function of control.

10 3. All control stations shall have a stop switch. When opened, the stop switch shall remove
11 the electrical power from the driving machine and brake. The stop switch shall:

12 3.1 Be manually operated;

13 3.2 Have red operating handles or buttons;

14 3.3 Be conspicuously and permanently marked "STOP";

15 3.4 Indicate the stop and run positions; and

16 3.5 Be arranged to be locked in the open position.

17 **3012.4 Capacity posting and no-riders sign.** Each material lift shall have a capacity sign
18 permanently and securely fastened in place in the material lift car and on the landings. The sign
19 shall indicate the rated load of the material lift in pounds. The sign shall be metal with black
20 letters two inches high on yellow background.

21 A sign stating "NO PERSONS PERMITTED TO RIDE THIS DEVICE" shall be
22 conspicuously and securely posted on the landing side of all hoistway gates and doors and in the

1 enclosure of each material lift car. The sign shall be metal with black letters 2 inches high on red
2 background.

3 SECTION 3013

4 REQUIREMENTS FOR NEW MATERIAL LIFTS

5 **3013.1 New material lifts.** New material lifts shall comply with ASME A17.1, Sections 2.7,
6 2.8 and 3.7. WAC 296-96 Part C1, Minimum Standards for All Material Lifts, as it existed on
7 February 15, 2013, applies to all material lifts as defined in Section 3004.

8 SECTION 3014

9 EMERGENCY SERVICE FOR ELEVATORS IN EXISTING BUILDINGS - PHASE I

10 RECALL

11 **3014.1 General.** All existing elevators requiring Phase I recall when installed or under Chapter
12 93 of the *Seattle Fire Code* shall comply with this section.

13 Exceptions:

- 14 1. Elevators that comply with the standards for new installations provided in Section
15 3018;
- 16 2. Elevators with less than 25 feet of travel if the *building official* and the fire code
17 official give written approval; and
- 18 3. Elevators that comply with ASME A17.1, Rule 211.3a 1984 edition or later and
19 Sections 3014.10 and 3014.11.

20 **3014.2 Phase I recall keyed switch.** A three-position (“on”, “off” and “by-pass”) key cylinder
21 switch shall be provided at each designated level within easy line of sight of the elevator
22 controlled by the switch. If additional switches are provided in a central control station they shall
23 be two position (“off” and “on”) key-operated switches.

1 **3014.3 Keyed cylinder-type switches.** Keyed cylinder-type switches shall comply with the
2 following:

- 3 1. Keys shall be removable only in the emergency (“on”) and normal (“off”) positions. Keys
4 shall not be removable in the by-pass position.
- 5 2. One key shall be provided for each Phase I switch or key cylinder.
- 6 3. All emergency operation cylinders (Phases I and II) shall be keyed alike but such key
7 shall not be a part of a building master key system.

8 **3014.4 Key location.**

- 9 1. A key box meeting the standards of Section 3011.3 shall be provided at the designated
10 recall floor above the Phase I recall switch. The key box is to be mounted approximately
11 6 feet above the floor. The *building official* is permitted to approve other locations upon
12 request.
- 13 2. When a central control station is provided, an additional set of keys shall be provided and
14 hung in the control station in a location designated by the fire chief. The keys shall be
15 identified by a ring or paddle.

16 **3014.5 Key switch functions.**

- 17 1. The three positions of the switch shall be marked “by-pass”, “off” and “on”.
- 18 2. If the switch is in the “off” position, normal elevator service shall be provided and smoke
19 detectors, if required, shall be functional.
- 20 3. If the switch is in the “by-pass” position, normal elevator service shall be restored
21 independent of any required smoke detectors.
- 22 4. If the switch is in the “on” position, the elevators are in Phase I elevator recall mode.

1 **3014.6 Phase I automatic recall operation.** If the Phase I recall switch is in the emergency
2 (“on”) position:

- 3 1. All cars controlled by this switch that are on automatic service shall return nonstop to the
4 designated level and power-operated doors shall open and remain open.
- 5 2. A car traveling away from the designated level shall reverse at or before the next
6 available floor without opening its doors.
- 7 3. A car stopped at a landing shall have the in-car emergency stop switch or in-car stop
8 switch rendered inoperative as soon as the doors are closed and the car starts toward the
9 designated level. A moving car, traveling to or away from the designated level, shall have
10 the in-car emergency stop or in-car stop switch rendered inoperative immediately.
- 11 4. A car standing at a floor other than the designated level, with doors open and in-car
12 emergency stop switch or in-car stop switch in the run position, shall conform to the
13 following:
 - 14 4.1 Elevators having automatic power-operated horizontally sliding doors shall close
15 the doors without delay and proceed to the designated level;
 - 16 4.2 Elevators having power-operated vertically sliding doors provided with automatic
17 or momentary pressure closing operation in accordance with ASME A17.1 Rule
18 112.3d 1984 or later edition shall have the closing sequence initiated without delay
19 in accordance with ASME A17.1 Rule 112.3d (1), (2), (3), and (5) 1984 or later
20 edition, and the car shall proceed to the designated level;
 - 21 4.3 Elevators having power-operated doors provided with continuous pressure closing
22 operation per ASME A17.1 Rule 112.3b 1984 or later edition or elevators having

1 manual doors shall conform to the requirements of Section 3014.7. Sequence
2 operation, if provided, shall remain effective.

3 5. Door reopening devices for power-operated doors that are sensitive to smoke or flame
4 shall be rendered inoperative. Mechanically actuated door reopening devices not sensitive
5 to smoke or flame shall remain operative. Car door open buttons shall remain operative.
6 Door closing shall conform to the requirements of ASME A17.1 Rule 112.5 1984 or later
7 edition. Door hold open switches shall be rendered inoperative.

8 6. All car and corridor call buttons and all corridor door opening and closing buttons shall
9 be rendered inoperative. All call register lights and directional lanterns shall be
10 extinguished and remain inoperative. Position indicators, if provided, shall remain in
11 service. All prior registered calls shall be canceled.

12 7. The activation of a smoke detector installed in accordance with Article 93 of the *Seattle*
13 *Fire Code* in any elevator lobby or associated elevator machine room, other than the
14 designated level, shall cause all cars in all groups that serve that lobby to return nonstop
15 to the designated level. The fire code official is permitted to approve the connection of
16 other detection devices to activate recall. The operation shall conform to the
17 requirements of Phase I emergency recall operation. Whenever new elevator controllers
18 are installed, they shall meet all provisions of the then current building and elevator
19 codes. Newly-installed controllers shall have the capability of selecting alternate recall
20 floors.

21 **3014.7 Attendant-operated recall operation.** Attendant-operated elevators shall be provided
22 with visible and audible signals that alert the operator to return to the lobby when the car has
23 been recalled under Phase I control.

1 **3014.8 Dual recall operation.** Elevators arranged for dual operation shall conform to all
2 requirements for automatic operation and attendant operation as applicable.

3 **3014.9 Inspection/maintenance recall operation.** During inspection operation the audible and
4 visible signals required in Section 3014.7 will be actuated when the car has been recalled under
5 Phase I control. The car shall remain under the control of the operator and/or car top station until
6 the car is returned to service.

7 **3014.10 Nurses' preemption.** Nurses' preemption (hospital service) is permitted to commandeer
8 up to one-half of the cars in a particular bank of elevators. At least one-half of the cars shall
9 respond to Phase I and all cars not preempted shall respond.

10 **3014.11 Operation instruction.** Instructions for operation of elevators under Phase I shall be
11 incorporated with or adjacent to the Phase I switch at the designated level. Instructions for
12 operation of elevators under Phase II shall be incorporated with or adjacent to the switch, in or
13 adjacent to the operating panel in each car. In addition, Phase I operating instructions shall be
14 adjacent to the Phase I switch in the fire control center and other *approved* locations.

15 Instructions shall be in letters not less than 1/8 inch (3.2 mm) in height and shall be
16 permanently installed and protected against removal or defacement.

17 **3014.12 Latching.** All cars responding to Phase I Recall, activated by a smoke detector or other
18 *approved* detection device, shall return to the appropriate recall floor as determined by the first
19 detector recall signal received. No device other than the Phase I switch is permitted to override
20 the first recall signal received. A later detection signal shall not change the recall floor. Smoke
21 detector activation shall only be reset manually.

SECTION 3015

EMERGENCY SERVICE FOR ELEVATORS IN EXISTING BUILDINGS - PHASE II

HIGH RISE IN-CAR OPERATION

3015.1 General. Existing elevators in buildings having floors used for human occupancy located more than 75 feet above the lowest level of fire department vehicle access, or buildings having floors used for human occupancy 35 feet above grade, which lack fire department vehicle access to at least one side shall have Phase II in-car operation and shall comply with this section.

Exceptions:

1. Elevators that comply with the standards for new installations as provided in Section 3019;
2. Elevators with less than 25 feet of travel when the *building official* and fire code official give written approval; and
3. Elevators that comply with ASME A17.1 Rule 211.3c 1984 or later edition.

3015.2 Phase II in-car operation key switch.

1. A two-position (“off” and “on”) key cylinder switch shall be provided in each elevator car.
2. The switch shall become effective only when the designated level Phase I switch is in the “on” position or a smoke detector has been activated and the car has returned to the designated level. The “on” position shall place the elevator in Phase II in-car operation.
3. The elevator shall be removed from Phase II operation only by moving the switch to the “off” position with the car at the designated level.
4. The switch shall be operable by the Phase I key and such key shall not be part of a building’s master key system.

1 5. The key shall be removable only in the “off” position.

2 6. One key shall be provided for each Phase II switch or key cylinder.

3 **3015.3 Key location.** See Section 3014.4 for the location of the keys.

4 **3015.4 Designated operator.** The operation of elevators on Phase II emergency in-car operation
5 shall be by trained emergency service personnel only.

6 **3015.5 Car operation only.** An elevator shall be operable only by a person in the car.

7 **3015.6 Corridor call buttons and directional lanterns.** All corridor call buttons and directional
8 lanterns shall remain inoperative.

9 **3015.7 Car and Hoistway Door Operation.** The operation of car and hoistway doors shall
10 comply with the following:

11 1. The opening of power-operated doors shall be controlled only by constant-pressure open
12 buttons or switches.

13 2. If the constant-pressure open button or switch is released prior to the doors reaching the
14 fully open position, the doors shall automatically reclose. Once doors are fully open, they
15 shall remain open until signaled to close.

16 3. The closing of power-operated doors shall be by constant pressure of either the call
17 button or door-close button. If a door-close button is supplied, it shall be operable.

18 4. If the constant-pressure close button or car call button is released prior to the doors
19 reaching the fully closed position, the doors shall automatically reopen. Once doors are
20 fully closed, they shall remain closed until signaled to open.

21 **Exception:** Momentary pressure control of doors using the sill trip-type operator may be
22 permitted as existing; however, the doors must not open automatically upon arrival at a floor.

1 **3015.8 Door reopening devices.** Smoke-sensitive door reopening devices and door hold-open
2 switches shall be rendered inoperative. Non-smoke-sensitive door reopening devices required to
3 be operative under all other conditions may be rendered inoperative under Phase II in-car
4 operation only if the doors are closed by constant pressure.

5 **3015.9 Car call cancellation.** All registered calls shall cancel at the first stop.

6 **3015.10 Direction of travel.** Direction of travel and start shall be by the car call buttons. With
7 doors in the closed position, actuation of the car call button shall select the floor, and start the car
8 to the selected floor. If no door-close button is available, constant pressure of the car call button
9 shall select the floor, close the door, and start the car to the selected floor.

10 **Exception:** On proximity-type car call buttons or any other type subject to false firing (calls
11 being placed by line spikes, intermittent loss of power, etc.), the doors shall be closed by a
12 door-close button. Floors may be selected either before or after closing of the doors. The car
13 will start only on the call button or door close button depending on which is the last device to
14 be actuated.

15 **3015.11 Motor generator time out.** The motor generator shall not time out automatically.

16 **3015.12 Car position indicators.** The car position indicators, when provided, shall be operative.

17 **3015.13 Phase II priority.** Phase II operation shall override any floor calls keyed out for
18 security reasons. Floor selection buttons shall be provided in the car to permit travel to all floors
19 served by the car. Means that prevent the operation of these buttons shall be rendered
20 inoperative.

21 **3015.14 False starts.** The elevator shall not start if no calls registered.

22 **3015.15 Terminal runs.** The elevator shall not make unprogrammed terminal runs.

1 **3015.16 Loss of power.** Elevators on fire emergency Phase II car operation shall remain in their
2 respective locations and in Phase II mode upon loss of power. They shall not move unless the
3 elevator is under the control of the operator and power has been restored.

4 **SECTION 3016**

5 **NEW INSTALLATIONS - CONSTRUCTION STANDARDS**

6 **3016.1 General.** All new elevators, escalators, moving walks, dumbwaiters and other
7 conveyances and their installation shall conform to the requirements of ASME A17.1 as amended
8 by this chapter.

9 **3016.2 Wall covering material for passenger cars.** Wall covering material for passenger cars
10 shall comply with the following:

- 11 1. ASME A17.1 Section 2.14.
- 12 2. *Seattle Building Code* requirements concerning flame spread ratings for wall coverings
13 and use of plastics. (See Chapter 8.)
- 14 3. WAC 296-96-23216 as it existed on February 15, 2013, except that interior finish
15 materials need not be firmly bonded flat to the enclosure and are permitted to be padded.

16 **3016.3 Seismic considerations.** New installations shall comply with ASME A17.1 Section 8.4.
17 The provisions for Seismic Zone 3 shall apply.

18 **3016.4 Requirements to accommodate people with disabilities.** All new elevators shall
19 comply with Chapter 11. In addition, WAC 296-96-02400 through 02605 applies.

20 **3016.5 Hoistway pressurization.** The requirements of Section 3016.5 apply in addition to
21 ASME A17.1, 2.1.4 and Section 713.14.

- 1 1. When pressurization is installed in elevator hoistways, the pressurization of the hoistway
2 shall be measured with all elevator systems in recall mode, Phase I, and all cars at the
3 designated recall level with the doors in the open position.
- 4 2. Activation of the fan serving the hoistway pressurization system may be delayed by up to
5 30 seconds so that elevator recall can be initiated prior to pressurizing the hoistway.
- 6 3. Unless specifically installed to serve that space only, environmental air systems and
7 pressurization systems shall not be located in hoistways, elevator mechanical rooms and
8 elevator machinery spaces.

9 **Exceptions:**

- 10 1. Pressurization ducts serving a hoistway that are separated from the room or space
11 by construction equal to the rated construction of the room or space and so located
12 that all required clearances are maintained.
- 13 2. Pressurization duct openings, dampers and grilles are permitted to be located in
14 hoistway shaft walls if the pressurization air does not impair the operation of the
15 elevator.
- 16 4 Hoistways shall not be pressurized through pressurization of elevator control rooms or
17 machine rooms. The machine room floor between the hoistway and overhead control
18 rooms or machine room shall contain as few penetrations as possible. All penetrations for
19 cable drops, etc., shall be held to a minimum size.
- 20 5. Elevator doors shall operate properly when hoistway pressurization is in effect.
- 21 6. Ventilation louver operating motors shall not infringe on any elevator machinery or
22 controller working clearances.

1 **3016.6 Elevator operation on emergency power.** All elevators required to be supplied with
2 emergency power shall comply with the following:

- 3 1. Each elevator shall be transferable to the emergency power supply system.
- 4 2. Emergency power supply systems capable of handling all elevators on the premises need
5 no sequencing or switching other than the possibility of staggering the restarting of the
6 generators.
- 7 3. Emergency power supply systems whose capacity can only handle one elevator of a
8 duplex or one elevator in each elevator group shall comply with the following.
 - 9 3.1 All elevators on automatic operation shall be automatically assigned emergency
10 power in sequence and returned to the Phase I recall or lobby floor, where they shall
11 open their doors and then time out of service.
 - 12 3.2 The last car down will generally be the selected car of a duplex or an elevator group
13 to remain in service. The service shall continue to be automatic.
 - 14 3.3 The assignment of emergency power will skip or rotate past cars that are out of
15 service (emergency stop switch pulled, malfunction, car top operation, etc.). If
16 assignment is made to a manual or attendant-operated car and the car is unattended,
17 the system shall rotate past the car as though it is out of service.
- 18 4. The lights for the car, control room, machine room and machine space shall be activated
19 on the emergency system.
- 20 5. A manual emergency power assignment switch or switches shall be in an elevator status
21 panel located in the fire department central control station. Each elevator shall be capable
22 of being assigned emergency power from this location. The manual switching shall be
23 effective at all times other than when the cars are automatically sequencing to the lobby

1 or when the selected car is traveling. The switch shall not remove power in midflight or
2 with doors closed.

3 6. Elevators on Phase II car operation shall remain in their respective locations upon loss of
4 power. They shall remain in Phase II mode and shall not move unless the elevator is
5 under the control of the operator and normal power has been restored or emergency
6 power has been assigned to the car by either automatic or manual means.

7 7. Loss of power and initiation of emergency power immediately after Phase I recall
8 operation has occurred shall not cause any cars to be stranded in the building. Upon the
9 application of emergency power to the equipment, the cars shall follow the normal
10 sequencing to the lobby, open their doors and time out of service. When all cars have
11 been bypassed (out of service) or returned to the lobby, the assigned car shall then
12 become available for firefighter's use on Phase II in-car operation.

13 8. Each elevator operating on emergency power shall be tested in accordance with
14 applicable ASME A17.1a-2013, 2.16.8, 2.26.10 and 2.27.2, and ASME A17.2-2014, Part
15 6.

16 9. If the elevator cars are recalled to the alternate floor by Phase I recall and a loss of power
17 occurs, the cars shall be sequenced to the alternate floor upon assignment of emergency
18 power. The cars shall not go to the primary designated recall floor under these conditions.
19 The alternate floor shall be provided with a means of identifying the elevator that is
20 supplied with emergency power.

21 10. The elevator position indicator system, if provided, shall not become disoriented due to
22 the loss of power or any other reason. However, upon the resumption of power, the car
23 may move to reestablish absolute car position.

1 11. Communications to the car shall remain in service.

2 **3016.7 Multiple hoistways.** The number of elevators permissible in a hoistway is as follows.

3 See ASME A17.1, 2.1.1.4.

4 1. No more than four elevators shall be in a single hoistway.

5 2. No more than three elevators serving all or the same portion of a building are permitted to
6 be in a single hoistway.

7 **Exception:** Four elevators serving all or the same portions of a building are permitted
8 to be in a common hoistway under the following conditions:

9 1. The hoistway is pressurized; and

10 2. Emergency generator power is available to serve both the elevators and
11 pressurization equipment.

12 **3016.8 Additional doors.** Doors other than the hoistway door and the elevator car door are
13 prohibited at the point of access to an elevator car.

14 **Exception:** Doors that are readily openable from the car side without a key, tool, or special
15 knowledge or effort.

16 **3016.9 Knox box 1400 series key retainer box.** A key retainer box that meets the requirements
17 of this section shall be provided.

18 1. The box shall be locked and keyed to the secure city access key for elevator and other
19 conveyance access and operation keys.

20 2. The box shall be located at the designated recall floor above the Phase I recall switch or
21 in the main lobby above the hall call button if no recall feature exists.

22 3. The box shall be flush or surface mounted approximately 6 feet above the floor.

1 4. The box shall be attached to the building so as to be able to withstand a force of 300 psf
2 applied horizontally at any point.

3 5. The box shall be large enough to accommodate all required keys.

4 6. The box shall be labeled "For Emergency Use."

5 7. The lock shall be high security Medeco lock specified by the *building official*.

6 8. The *building official* may approve other locations and custom box types upon request.

7 **3016.10 Elevator access keys.** Keys for access to and for the operation of elevator and other
8 conveyance equipment shall tagged and retained in the key retainer box. The key retainer box
9 shall contain fire emergency service keys (Phase I and II, one key for each switch) and keys to all
10 of the following that are in the building:

11 1. Doors to the control room, machine room and machine space;

12 2. Doors preceding elevator control room, machine room, and machine space;

13 3. Secondary level door;

14 4. Pit door;

15 5. Roof door;

16 6. Independent, hospital emergency and attendant operation;

17 7. Hoistway access;

18 8. Mechanical hoistway access devices (broken arm, lunar, etc.);

19 9. Lighting and fan;

20 10. Fob or card reader for secured car calls and or hall call buttons;

21 11. Miscellaneous switch keys;

22 12. Fire alarm panel room;

23 13. Sprinkler valve control; room;

1 14. Fire command center;

2 15. Elevator central control station/panel.

3 **3016.11 Escalator and moving walk conveyance number designation.** In any building with
4 more than one escalator or moving walk, a designating number (not less than two inches in
5 height) shall be located on the upper and lower front plates.

6 **[W] 3016.12 Elevator car to accommodate ambulance stretcher.** In buildings provided with
7 an elevator, at least one elevator shall provide fire department emergency access to all floors
8 served in:

- 9 1. buildings four or more stories above or below grade plane, and
- 10 2. any R-1, R-2 or I occupancy building regardless of the number of stories.

11 The elevator car shall be of a size and arrangement to accommodate a 24-inch by 84-inch
12 (610 mm by 2134 mm) ambulance stretcher with not less than 5-inch (127 mm) radius corners,
13 in the horizontal, open position. The elevator shall be identified by the international symbol for
14 emergency medical services (star of life). The symbol shall not be less than 3 inches (76 mm) in
15 height and shall be placed inside on both sides of the hoistway door frame on both the designated
16 level and the alternate level.

17 Exception: Private residence elevators are not required to comply with this section.

18 **Note:** The stretcher-sized elevator car may also serve as an *accessible means of egress* as
19 required by Section 1009.2.1 of the *Seattle Building Code*.

20 **3016.13 Signs.** A sign complying with ASME A17.1 2.27.9 shall be posted in the elevator lobby
21 of every elevator equipped for firefighters' emergency operation. The signs shall be located
22 above each hall call fixture noting that the elevators will be recalled to the building lobby on fire
23 alarm.

1 **Exception:** If *approved* by the *building official*, signs need not be posted in lobbies at the
2 main egress level if the means of egress are obviously identifiable.

3 A sign indicating the number or alphabet of each elevator shall be posted and maintained in
4 the elevator lobby at the designated recall level and at alternate recall floors, if provided.

5 **3016.14 Fire service access elevators and occupant evacuation elevators.** See Section 403
6 and ASME A17.1 for provisions related to fire service access elevators and occupant evacuation
7 elevators.

8 **3016.15 Energy efficiency.** Elevator systems shall comply with the Seattle Energy
9 Conservation Code.

Note: The Seattle Energy Code includes the following provisions for energy efficiency of
elevators and escalators.

C405.9.1 Elevator cabs. For the luminaires in each elevator cab, not including signals
and displays, the sum of the lumens divided by the sum of the watts shall be no less
than 35 lumens per watt. Ventilation fans in elevators that do not have their own air
conditioning system shall not consume more than 0.33 watts/cfm at the maximum rated
speed of the fan. Controls shall be provided that will de-energize ventilation fans and
lighting systems when the elevator is stopped, unoccupied and with its doors closed for
over 15 minutes.

C405.9.2 Escalators and moving walks. Escalators and moving walks shall comply
with ASME A17.1/CSA B44 and shall have automatic controls configured to reduce
speed to the minimum permitted speed in accordance with ASME A17.1/CSA B44 or
applicable local code when not conveying passengers.

Exception: A power factor controller that reduces operating voltage in response to light loading conditions ((may)) is permitted to be provided in lieu of the variable speed function.

C405.9.3 Regenerative drive. An escalators designed either for one-way down operation only or for reversible split shall have a variable frequency regenerative drive that supplies electrical energy to the building electrical system when the escalator is loaded with passengers whose combined weight exceeds 750 pounds.

1 **3016.16 Elevator landing illumination.** Elevators shall comply with ASME A17.1, 2.11.10.2
2 Illumination at Landing Sills, as amended below.

3 **2.11.10.2 Illumination at Landing Sills.** The building corridors shall be so lighted that the
4 illumination at the landing sills, when an elevator is in service, shall be not less than 100 lx
5 (10 fc). Illumination under emergency power shall comply with Section 1008.

6 SECTION 3017

7 NEW INSTALLATIONS - GENERAL EMERGENCY OPERATION REQUIREMENTS

8 **3017.1 General.** All elevators shall conform to the requirements of this section and the specific
9 requirements of Sections 3018 and 3019.

10 **3017.2 Central control stations.** The following criteria shall be met if buildings provide a fire
11 command center in accordance with Section 911:

- 12 1. An additional two-position (“off” and “on”) Phase I recall switch for each elevator or
13 elevator group shall be installed when the control station is not within easy line of sight
14 of the lobby Phase I recall switches; the switch(es) shall be rotated clockwise to go from
15 “off” to “on” position;

1 2. A car position indicator shall be permanently installed, which shall be of a positive type
2 that will not lose the car position nor need resetting on loss of power. Reading of the
3 indicator shall not require special knowledge.

4 3. Firefighter's phone jacks shall be provided that allow each elevator car to be connected to
5 the fire control center;

6 **Exception:** Fire department radio systems may be provided in lieu of phone jacks if
7 approved by the fire department.

8 4. A manual emergency power assignment switch;

9 5. A Phase I indicator;

10 6. A Phase II indicator.

11 **3017.3 Nurses' preemption.** Nurses' preemption (hospital service) may be allowed to
12 commandeer up to one-half of the cars in a particular bank of elevators. At least one-half of the
13 cars shall respond to Phase I and all cars not preempted shall respond.

14 **3017.4 Phase I and II operation instructions.** Operation instructions shall be available in
15 accordance with ASME A17.1, 2.27.7. In addition, Phase I operating instructions shall be
16 adjacent to the Phase I switch in the fire command center and other *approved* locations. The
17 Phase II operation instructions shall identify the location of the elevator machine rooms and
18 control rooms.

19 **3017.5 Fireman's visual signal, ASME 2.27.3.2.6.** Elevators requiring Phase I or Phase II
20 operation shall comply with ASME 2.27.3.2.6 as amended below:

21 When Phase I Emergency Recall Operation is initiated by a (~~fire alarm initiating device~~) smoke
22 or heat detector for any location listed in 2.27.3.2.6(a) through (e), as required by 2.27.3.2.3 or
23 2.27.3.2.4, or Phase II Emergency In-Car Operation as required by 2.27.3.3, the visual signal [see

1 2.27.3.1.6(h) and Fig. 2.27.3.1.6(h)] shall illuminate intermittently only in a car(s) with
2 equipment in that location, as follows:

3 (a) machine room

4 (b) machinery space containing a motor controller or driving machine

5 (c) control room

6 ~~((d) control space))~~

7 (e) hoistway

8 SECTION 3018

9 NEW INSTALLATIONS – PHASE I RECALL REQUIREMENTS

10 **3018.1 ASME A17.1, 2.27.3 General.** ASME A17.1, 2.27.3, Firefighters' Emergency Operation:
11 Automatic Elevators, is superseded by the following.

12 Phase I emergency recall operation shall be provided for all elevators with fully automatic
13 open and close power-operated doors.

14 **3018.2 ASME A17.1, 2.27.3.1 Phase I emergency recall operation.** Elevators requiring Phase
15 I recall emergency operation shall comply with ASME A17.1, 2.27.3.1 Phase I Emergency
16 Recall Operation, and the following:

17 Elevator groups containing four or more cars shall be provided with two, three-position key
18 switches per group. Two-position (“off” and “on”) switches shall be provided in the fire
19 command center if this code requires such a center. The switch(es) shall be rotated clockwise
20 to go from “off” to “on” position. Hall call buttons common to an elevator group shall
21 remain in service unless both Phase I recall switches of a four-car or larger group are placed
22 in the recall mode, or a fire alarm recall signal is initiated.

1
2
3
4
5
6
7
8
9
10
11
12
13
14
15
16
17
18
19
20
21
22
23

SECTION 3019

**NEW INSTALLATIONS - PHASE II IN-CAR OPERATION REQUIREMENTS (ASME
A17.1, 2.27.8)**

3019.1 Phase II In-car Operation. Elevators requiring Phase II in-car operation shall comply with ASME A17.1, 2.27.8 Switch Keys, as amended below.

ASME 2.27.8 Switch Keys. The key switches required by 2.27.2 through 2.27.5 and 2.27.11 for all elevators in a building shall be operable by the FEO-K1 key. The keys shall be Group 3 Security (see 8.1). A separate key shall be provided for each switch. These keys shall be kept in the key retainer box required by Section 3016.9 or 3016.16. ~~((on the premises in a location readily accessible to firefighters and emergency personnel, but not where they are available to the public.))~~ This key shall be of a tubular, 7 pin, style 137 construction and shall have a bitting of 6143521 starting at the tab sequenced clockwise as viewed from the barrel end of the key and cutting depths shall be in accordance with Fig. 2.27.8. The key shall be coded "FEO-K1." The possession of the "FEO-K1" key shall be limited to elevator personnel, emergency personnel, elevator equipment manufacturers, and authorized personnel during checking of Firefighters' Emergency Operation (see 8.1 and 8.6.11.1).

~~((Where provided, a lock box, including its lock and other components, shall conform to the requirement of UL 1037 (see Part 9).~~

~~NOTE (2.27.8): Local authorities may specify additional requirements for a uniform keyed lock box and its location to contain the necessary keys.))~~

SECTION 3020

**NEW INSTALLATIONS - CONSTRUCTION OF HOISTWAYS, MACHINE ROOMS
AND CONTROL ROOMS**

1 **3020.1 Construction of hoistways.** All new elevator hoistways shall comply with ASME
2 A17.1, section 2.1 as amended below.

3 SECTION 2.1

4 CONSTRUCTION OF HOISTWAYS AND HOISTWAY ENCLOSURES

5 2.1.1 Hoistway Enclosures

6 ~~((Hoistway enclosures shall conform to 2.1.1.1, 2.1.1.2, or 2.1.1.3.))~~

7 Hoistways that penetrate a floor/ceiling assembly shall be protected by a fire-resistance-rated
8 enclosure complying with this section.

9 Exceptions:

10 1. In other than Group H occupancies, an enclosure is not required for elevators located
11 within atriums complying with Section 404. The elevator is required to comply with

12 2.1.1.3.

13 2. Hoistway enclosures are not required to be fire-resistance rated as provided in items

14 2.1 and 2.2.

15 2.1 In parking garages, hoistway enclosures that serve only the parking garage are not
16 required to be rated.

17 2.2 In other than Groups I-2 and I-3, hoistway enclosures are not required to be rated,

18 if the hoistway:

19 2.2.1 Does not connect more than two stories.

20 2.2.2 Does not open to a corridor in Group I and R occupancies.

21 2.2.3 Does not open to a corridor on nonsprinklered floors in any occupancy.

22 2.2.4 Is separated from floor openings and air transfer openings serving other
23 floors by construction conforming to required shaft enclosures.

1 2.2.5 Is limited to one smoke compartment.

2 **2.1.1.1 Fire-Resistive Construction**

3 **2.1.1.1.1** Where rated hoistway enclosures are required, the enclosure shall be of fire-
4 resistance rated construction as required for shafts by Section 713.4. ~~((Where fire-resistive~~
5 ~~construction is required, hoistways shall be enclosed in conformance with the requirements of~~
6 ~~the building code (see 1.3).))~~

7 **2.1.1.1.2** Partitions between hoistways and machine rooms and control rooms

8 ~~((a) machinery spaces outside the hoistway~~

9 ~~(b) machine rooms~~

10 ~~(c) control spaces outside the hoistway~~

11 ~~(d) control rooms that have))~~ shall be fire partitions complying with Section 708 having a

12 fire-resistive rating of at least one hour, or shall be of noncombustible solid ~~((or openwork))~~

13 construction ~~((that meets the requirements of 2.1.1.2.2(d)(1), (2), and (3))).~~ Partitions ~~((of~~

14 ~~solid construction))~~ shall be permitted to have openings essential for ropes, drums, sheaves,

15 and other elevator equipment.

16 ~~((Openwork construction shall reject a ball 25 mm (1 in.) in diameter, except where there are~~
17 ~~openings essential for ropes, drums, sheaves, and other elevator equipment.))~~

18 **2.1.1.1.3** Hoistway enclosure openings shall be protected in accordance with Section 716 as
19 required for fire partitions. Doors shall be self- or automatic-closing by smoke detection in

20 accordance with Section 716.5.9.3. ~~((with entrances or access doors having a fire-protection~~

21 ~~rating conforming to the requirements of the building code.))~~

1 **2.1.1.2 Non-Fire-Resistive Construction**

2 **2.1.1.2.1** Where fire-resistive construction is not required by 2.1.1, ~~((the building code,))~~

3 hoistway construction shall conform to 2.1.1.2.2 or 2.1.1.3.

4 **2.1.1.2.2** The hoistway shall be fully enclosed ~~((conforming to 2.1.1.2.2(a), (b), (c), and (d); or~~
5 ~~2.1.1.2.2(a), (b), and (e).~~

6 ~~(a) Enclosures and doors shall be unperforated to a height of 2 000 mm (79 in.) above each floor~~
7 ~~or landing and above the treads of adjacent stairways. The enclosure shall be unperforated,~~
8 ~~adjacent to, and for 150 mm (6 in.) on either side of any moving equipment that is within 100~~
9 ~~mm (4 in.) of the enclosure.))~~

10 ~~(b) Partitions between hoistways and machine rooms and control rooms~~

11 ~~(((1) machinery spaces outside the hoistway~~

12 ~~(2) machine rooms~~

13 ~~(3) control spaces outside the hoistway~~

14 ~~(4) control rooms))~~

15 shall be of solid ~~((or openwork))~~ construction ~~((that meets the requirements of 2.1.1.2.2(d)(1),~~
16 ~~(2), and (3)))~~. Partitions of solid construction shall be permitted to have openings essential for
17 ropes, drums, sheaves, and other elevator equipment. ~~((Openwork construction shall reject a ball~~
18 ~~25 mm (1 in.) in diameter, except where there are openings for ropes, drums, sheaves, and other~~
19 ~~elevator equipment.~~

20 ~~(e) Openwork enclosures, where used above the 2 000 mm (79 in.) level, shall reject a ball 25~~
21 ~~mm (1 in.) in diameter.~~

22 ~~(d) Openwork enclosures shall be~~

23 ~~(1) at least 2.2 mm (0.087 in.) thick wire, if of steel wire grille~~

1 ~~(2) at least 2.2 mm (0.087 in.) thick, if of expanded metal~~

2 ~~(3) so supported and braced as to deflect not over 15 mm (0.6 in.) when subjected to a force of~~
3 ~~450 N (100 lbf) applied horizontally at any point))~~

4 (e) Enclosures shall be permitted to be glass, provided it is laminated glass conforming to ANSI
5 Z97.1, 16 CFR Part 1201(~~(, or CAN/CGSB 12.1, whichever is applicable (see Part 9))~~).

6 Markings as specified in the applicable standard shall be on each separate piece of glass and shall
7 remain visible after installation.

8 **2.1.1.2.3** Entrances shall be in conformance with 2.11, except 2.11.14, 2.11.15, 2.11.16, and
9 2.11.18.

10 **2.1.1.3 Partially Enclosed Hoistways.** For elevators that are not required to be fully enclosed
11 by 2.1.1, protection at least 2 400 mm (94.5 in.) high shall be provided on the hoistway sides that
12 are located 1 500 mm (59 in.) or less from elevator equipment to areas accessible to other than
13 elevator personnel. Such protection shall comply with 2.1.1.2.

14 **2.1.1.4 Multiple Hoistways.** The number of elevators permissible in a hoistway shall be in
15 conformance with the building code.

16 **2.1.1.5 Strength of Enclosure.** The hoistway enclosure adjacent to a landing opening shall be of
17 sufficient strength to maintain, in true lateral alignment, the hoistway entrances. Operating
18 mechanisms and locking devices shall be supported by the building wall, if load-bearing, or by
19 other building structure. Adequate consideration shall be given to pressure exerted on hoistway
20 enclosures as a result of windage and elevator operation. In high-rise buildings in Risk Category
21 III or IV in accordance with Section 1604.5, for fire service access elevators according to Section
22 403.6.1, and in all buildings that are more than 420 feet (128 m) in building height, hoistway
23 enclosures shall comply with Section 403.2.3.

1 **3020.2 Private residence elevator hoistways.** Hoistways for private residence elevators shall
2 comply with Section 3020.1. ASME A17.1, 5.3.1.1, 5.3.1.1.1 and 5.3.1.1.2 do not apply.

3 **3020.3 Location of equipment.** Motor controllers, motion controllers and drives shall not be
4 located in hoistways.

5 **3020.4 Elevator machine rooms and control rooms.** Elevator controls and machinery other
6 than driving machines and governors shall be located in a room dedicated exclusively to elevator
7 equipment. Listed electrical equipment that serves the machine room is permitted to be installed
8 in machine rooms. Air conditioning equipment is permitted to be installed in machine rooms in
9 accordance with ASME A17.1, 2.8.5.

10 **3020.4.1 Fire-resistance rating of machine and control rooms.** Elevator machine rooms
11 and control rooms that are adjacent to the hoistway with unprotected openings into the
12 hoistway shall be enclosed by fire partitions and horizontal assemblies with a fire-resistance
13 rating of at least one-hour but not less than the rating of the hoistway. The separation between
14 the room and the hoistway is permitted to be nonrated. Exterior walls and roofs are not
15 required to have a fire-resistance rating unless required by other sections of this code.

16 ASME A17.1 sections 2.7.1.1 and 2.7.1.2 are superseded by this section.

17 **3020.4.2 Machine rooms and control rooms for electric elevators.** All machine rooms and
18 control rooms for electric elevators shall comply with ASME A17.1 Section 2.7, Enclosure of
19 Machine Rooms and Machinery Spaces, except 2.7.1.1 and 2.7.1.2.

20 **3020.4.3 Machine rooms and control rooms for hydraulic elevators.** All machine rooms
21 and control rooms for hydraulic elevators shall have fire-resistive construction as required by
22 Section 3020.4. Hydraulic elevator machine and control rooms are permitted to be located
23 overhead, adjacent to, underneath the hoistway, or at a remote location. They shall not be

1 located in the hoistway. Where hydraulic machines and electrical control equipment are
2 located in spaces separated from the hoistway enclosure (see ASME 2.1.1 and 3020.1), such
3 spaces shall be separated from other parts of the building by enclosures conforming to ASME
4 2.7.1.2 as amended by this code. ASME A17.1 Section 3.7 is superseded by this section.

5 **3020.5 Working clearances.** The following working clearances shall be provided inside the
6 machine room or control room for all elevators.

- 7 1. The width of working space in front of controllers shall be the width of the controller or
8 30 inches, whichever is greater. The depth of the working space in the direction of access
9 shall be not less than 48 inches.
- 10 2. The minimum clear space working clearances for free-standing equipment shall be 18
11 inches on two sides and between units of controllers, selectors and/or walls or other
12 building obstructions. The 18 inch side clearance is permitted to be combined to permit
13 36 inches clear on one side only.
- 14 3. The minimum space at the rear of controllers with back-wiring, terminals or other
15 elements requiring access shall be 36 inches.
- 16 4. The working space shall be free of pipes, vents, storage, ducts or any other obstruction.

17 **Exception:** If approved by the *building official*, space outside elevator control rooms and
18 machine rooms is permitted to be used to provide working clearance required for the front of
19 controllers for rooms containing only elevator controls. If the space outside the room serves
20 as a means of egress, not more than one-half the required egress width shall overlap the
21 working clearance. If space outside the control room or machine room is used to provide
22 working clearance, means shall be provided for protection of the working clearance during
23 alteration, repair and maintenance of elevator equipment. The working clearance shall be

1 located in conditioned space. The room where the controls or machines are located shall
2 comply with all other requirements for control rooms or machine rooms.

3 **3020.6 Machine rooms or control rooms for private residence elevators.** Private residence
4 elevators shall be provided with a machine room or control room. No fire resistance rating is
5 required for private residence elevator equipment or machine rooms.

6 **3020.7 Labeling.** Elevator machine and control rooms shall be identified by a permanent label
7 on the door of the room. In buildings with more than one machine room or control room, the
8 label shall identify which cars are served by the equipment in the room.

9 SECTION 3021

10 NEW INSTALLATIONS - FLOORS

11 **3021.1 Floors.** All new elevator hoistways, machine rooms and control rooms shall comply
12 with ASME A17.1, 2.1.3.3, Construction of Floors, as amended below. ASME A17.1, 2.1.3.4 is
13 not adopted.

14 **ASME 2.1.3.3 Construction of Floors.** Floors of hoistways, control rooms and machine rooms
15 shall ~~((be of concrete or metal construction with or))~~ have a coated concrete or metal surface
16 without perforations that will resist absorption of oil, grease and similar materials. Control
17 rooms and machine rooms shall have floors that cover the entire area of the room. ((Metal floors
18 shall conform to the following:

19 ~~(a) If of bar type grating, the openings between bars shall reject a ball 20 mm (0.8 in.) in~~
20 ~~diameter.~~

21 ~~(b) If of perforated sheet metal or of fabricated openwork construction, the openings shall reject~~
22 ~~a ball 25 mm (1 in.) in diameter.))~~

SECTION 3022

**EQUIPMENT IN HOISTWAYS, MACHINE ROOMS AND CONTROL ROOMS (ASME
A17.1 Section 2.8)**

3022.1 Prohibited wiring, pipes and ducts. In accordance with ASME A17.1 Section 2.8 non-elevator electric wiring, pipes and ducts are prohibited in elevator machine rooms, control rooms and hoistways except as otherwise provided in this section. The use of false ceilings and furring does not remove such items from the elevator spaces and shall not be acceptable except as allowed by ASME A17.1, 2.8.2 as amended below.

3022.2 Amendment to ASME A17.1 2.8.3 All elevator hoistways, machine rooms and control rooms shall comply with ASME A17.1 2.8.1 and 2.8.3, as amended below.

ASME 2.8 Equipment in Hoistways, Machinery Spaces, Machine Rooms, (~~Control Spaces,~~) and Control Rooms

2.8.1 Equipment Allowed. Only machinery and equipment used directly in connection with the elevator shall be permitted in elevator hoistways, machinery spaces, machine rooms, (~~control spaces,~~) and control rooms.

2.8.3 Pipes, Ducts, Tanks, and Sprinklers

2.8.3.1 (~~Steam and hot water pipes shall be~~) Pipes conveying gases, vapors or liquids are not permitted to be installed in hoistways, machinery spaces, machine rooms, (~~control spaces,~~) and control rooms unless necessary for operation or maintenance of the elevator and not used for any other purpose. (~~for the purpose of heating these areas only, subject to 2.8.3.1.1 through 2.8.3.1.3~~).

Exception: Subject to the approval of the *building official*, pipes that are not necessary for operation or maintenance of the elevator are permitted in machinery spaces, machine rooms and

1 control rooms if they are protected with double containment and the joints within the machine
2 space, machine room or control room are threaded, soldered or welded. Pipes shall not be
3 located less than 7 feet above the floor in machine rooms.

4 ~~((2.8.3.1.1 Heating pipes shall convey only low pressure steam [100 kPa (15 psi) or less] or hot~~
5 ~~water [100° C (212° F) or less].~~

6 ~~2.8.3.1.2 All risers and return pipes shall be located outside the hoistway. When the machinery~~
7 ~~space, machine room, control space, or control room is located above the roof of the building,~~
8 ~~heating pipes for the machinery space, machine room, control space, or control room shall be~~
9 ~~permitted to be located in the hoistway between the top floor and the machinery space, machine~~
10 ~~room, control space, or control room.~~

11 ~~2.8.3.1.3 Traps and shutoff valves shall be provided in accessible locations outside the~~
12 ~~hoistway.))~~

13 ~~2.8.3.2 Ducts shall be permitted to be installed in the hoistway, ((machinery space,)) machine~~
14 ~~room, ((control space,)) or control room for the purpose of heating, cooling, ventilating, and~~
15 ~~venting these areas only and shall not encroach upon the required clearances.~~

16 Ducts and electrical conduit are permitted to pass through an elevator machine room or control
17 room if they are separated from the room by construction equal to the rated construction of the
18 room and so located that all required clearances are maintained.

19 ~~2.8.3.3 Sprinkler systems conforming to NFPA 13 ((or the NBCC, whichever is applicable (see~~
20 ~~Part 9))) shall be permitted to be installed in the hoistway, ((machinery space,)) machine room,~~
21 ~~((control space,)) or control room subject to rules promulgated by the building official.~~

22 ~~((2.8.3.3.1 through 2.8.3.3.4.~~

1 ~~2.8.3.3.1 All risers shall be located outside these spaces. Branch lines in the hoistway shall~~
2 ~~supply sprinklers at not more than one floor level. When the machinery space, machine room,~~
3 ~~control space, or control room is located above the roof of the building, risers and branch lines~~
4 ~~for these sprinklers shall be permitted to be located in the hoistway between the top floor and the~~
5 ~~machinery space, machine room, control space, or control room.~~

6 ~~2.8.3.3.2 In jurisdictions not enforcing the NBCC, where elevator equipment is located or its~~
7 ~~enclosure is configured such that application of water from sprinklers could cause unsafe~~
8 ~~elevator operation, means shall be provided to automatically disconnect the main line power~~
9 ~~supply to the affected elevator and any other power supplies used to move the elevator upon or~~
10 ~~prior to the application of water.~~

11 ~~(a) This means shall be independent of the elevator control and shall not be self-resetting.~~

12 ~~(b) Heat detectors and sprinkler flow switches used to initiate main line elevator power shutdown~~
13 ~~shall comply with the requirements of NFPA 72.~~

14 ~~(c) The activation of sprinklers outside of such locations shall not disconnect the main line~~
15 ~~elevator power supply. See also 2.27.3.3.6.~~

16 ~~2.8.3.3.3 Smoke detectors shall not be used to activate sprinklers in these spaces or to disconnect~~
17 ~~the main line power supply.))~~

18 ~~2.8.3.3.4 ((In jurisdictions not enforcing the NBCC, when))~~ Where sprinklers are installed not
19 more than 600 mm (24 in.) above the pit floor, 2.8.3.3.4(a) and (b) apply to elevator electrical
20 equipment and wiring in the hoistway located less than 1200 mm (48 in.) above the pit floor,
21 except earthquake protective devices conforming to 8.4.10.1.2(d); and on the exterior of the car
22 at the point where the car platform sill and the lowest landing hoistway door sill are in vertical
23 alignment.

1 (a) Elevator electrical equipment shall be weatherproof (Type 4 as specified in NEMA 250).

2 (b) Elevator wiring, except traveling cables, shall be identified for use in wet locations in
3 accordance with the requirements in the Seattle Electrical Code. ~~((NFPA 70.))~~

4 **2.8.3.4** Other pipes or ducts conveying gases, vapors, or liquid and not used in connection with
5 the operation of the elevator shall not be installed in any hoistway, machinery space, machine
6 room, ~~((control space,))~~ or control room. Where a machinery space, machine room, ~~((control~~
7 ~~space,))~~ or control room, or hoistway extend above the roof of a building, pipes shall be
8 permitted from roof drains to the closest point where they can be diverted out of this space.
9 Pipes shall be covered to prevent leakage or condensate from entering the machinery space,
10 machine room, ~~((control space,))~~ control room, or hoistway.

11 **2.8.3.5** Where permitted and provided, pipes, drains, and tanks, or similar equipment that
12 contains liquids, shall not be located directly above the elevator equipment and shall not
13 encroach upon the required clearances in the hoistway, ~~((machinery space,))~~ machine room,
14 ~~((control space,))~~ or control room.

15 SECTION 3023

16 PITS (ASME A17.1, 2.2.2)

17 **3023.1 Design and Construction of Pits.** The design and construction of elevator pits shall
18 comply with ASME A17.1, 2.2.2 as amended below:

19 **2.2.2.1** The construction of the pit walls, the pit floor, and any pit access doors (see 2.2.4)
20 shall conform to 2.1.1 and 2.1.2.

21 **2.2.2.2** The floor of the pit shall be approximately level, except that

1 (a) trenches or depressions shall be permitted for the installation of buffers, compensating
2 sheaves and frames, and vertically sliding biparting hoistway doors, where structural
3 conditions make such trenches or depressions necessary

4 (b) in existing buildings, where new elevators are installed or existing elevators are altered,
5 existing foundation footings extending above the general level of the pit floor shall be
6 permitted to remain in place, provided that the maximum encroachment of such footings does
7 not exceed 15% of the cubic content of the pit, and further provided that it is impracticable to
8 remove the footing.

9 **2.2.2.3** Permanent provisions shall be made to prevent accumulation of ground water in the
10 pit (see 2.1.2.2).

11 **2.2.2.4** Drains and sump pumps, where provided, shall comply with the applicable plumbing
12 code, and they shall be provided with a positive means to prevent water, gases, and odors
13 from entering the hoistway.

14 **2.2.2.5** In elevators that are fire service access or occupant evacuation elevators (~~provided~~
15 ~~with Firefighters' Emergency Operation~~), a drain or sump pump shall be provided in the
16 area of the pit that serves those elevators. The sump pump/drain shall have the capacity to
17 remove a minimum of 11.4 m³/h (3,000 gal/h) per ~~((elevator))~~ hoistway.

18 **2.2.2.6** Sumps and sump pumps in pits, where provided, shall be covered. The cover shall be
19 secured and level with the pit floor.

20 All elevators other than fire service access and occupant evacuation elevators shall be
21 provided with sump holes that are at least 18 inches by 18 inches by 18 inches per hoistway.

1 **3023.2 Access to Pits.** All pits shall comply with ASME A17.1, 2.2.4 as amended below:

2 **ASME 2.2.4 Pit Access.** Safe and convenient access shall be provided to all pits, and shall
3 conform to 2.2.4.1 through 2.2.4.6.

4 **2.2.4.1** Access shall be by means of the lowest hoistway door or by means of a separate pit
5 access door.

6 **2.2.4.2** There shall be installed in the pit of each elevator, where the pit extends more than 900
7 mm (35 in.) below the sill of the pit access door (lowest hoistway door or separate pit access
8 door), a fixed vertical ladder of noncombustible material, located within reach of the access door.

9 The ladder is permitted to be retractable or nonretractable. Nonretractable ladders, where
10 provided, shall conform to 2.2.4.2.1 through 2.2.4.2.6. Retractable ladders, where provided, shall
11 conform to 2.2.4.2.1 through 2.2.4.2.3 and 2.2.4.2.5 through 2.2.4.8. When in the extended
12 position, retractable ladders shall conform to 2.2.4.2.4.

13 **2.2.4.2.1** The ladder shall extend not less than 1 200 mm (48 in.) above the sill of the access
14 door or handgrips shall be provided to the same height.

15 **2.2.4.2.2** The ladder rungs, cleats, or steps shall be a minimum of 400 mm (16 in.) wide. When
16 obstructions are encountered, the width shall be permitted to be decreased to less than 400 mm
17 (16 in.). The reduced width shall be as wide as the available space permits, but not less than 225
18 mm (9 in.).

19 **2.2.4.2.3** The ladder rungs, cleats, or steps shall be spaced 300 mm (12 in.) \pm 13 mm (\pm 0.5 in.)
20 on center, shall be provided to not less than the height of access door sill, and shall be designed
21 to minimize slipping (e.g. knurling, dimpling, coating with skid-resistant material, etc.).

22 **2.2.4.2.4** A clear distance of not less than 115 mm (4.5 in.) from the centerline of the rungs,
23 cleats, or steps to the nearest permanent object in back of the ladder shall be provided.

1 **2.2.4.2.5** Side rails, if provided, shall have a clear distance of not less than 115 mm (4.5 in.)
2 from their centerline to the nearest permanent object.

3 **2.2.4.2.6** The ladder and its attachments shall be capable of sustaining a load of 135 kg (300 lb.)

4 **2.2.4.2.7** Retractable ladders that are in the line of movement of the car or counterweight when
5 not fully retracted, shall operate a retractable ladder electrical device (see 2.26.2.38) that shall
6 cause the power to be removed from the elevator driving-machine motor and brake unless the
7 ladder is in its fully retracted position.

8 **2.2.4.2.8** Retractable ladders shall be capable of being extended, mechanically secured and
9 unsecured, and retracted from the access door, and

10 (a) the force(s) required to extend a retractable ladder from the fully retracted position to the
11 extended and mechanically secured position shall not exceed 220 N (50 lbf)

12 (b) after being extended and mechanically secured, a retractable ladder shall remain secured in
13 the extended position when subjected to a horizontal force not to exceed 2 220 N (500 lbf)

14 (c) the force(s) required to retract a retractable ladder from its extended position to its fully
15 retracted position, after being unsecured, shall not exceed 220 N (50 lbf)

16 (d) the ladder shall be mechanically secured when in the retracted position

17 **2.2.4.3** Pit access by a ladder shall not be permitted when the pit floor is more than 3 000 mm

18 (120 in.) below the sill of the access door, except where there is no building floor below the

19 bottom terminal landing, this height shall be permitted to be greater but not more than 4 200 mm

20 (165 in.).

21 **2.2.4.4** Pits shall be accessible only to elevator personnel.

1 **2.2.4.5** Separate pit access door, when provided, shall be subject to the following requirements:

2 (a) If the door swings into the pit, it shall be located so that it does not interfere with moving
3 equipment.

4 (b) If the door swings out, and the lowest structural or mechanical part, equipment, or device
5 installed beneath the car platform, except guide shoes or rollers or safety jaw assemblies, projects
6 below the top of the separate pit access door opening when the car is level with the bottom
7 terminal landing

8 (1) an electric contact conforming to 2.26.2.26 shall be provided to prevent operation of the
9 elevator when the door is open

10 (2) the door shall be provided with a vision panel(s) that is glazed with clear wired glass not less
11 than 6 mm (0.25 in.) thick, will reject a ball 150 mm (6 in.) in diameter, and have an area of not
12 more than 0.03 m² (47 in.²).

13 (c) The door shall provide a minimum opening of 750 mm (29.5 in.) in width and ~~((1-825))~~ 2 032
14 mm ~~((72))~~ 80 in.) in height.

15 (d) The door shall be equipped with a barrier conforming to 2.11.1.2(i), where the door sill is
16 located more than 300 mm (12 in.) above the pit floor.

17 (e) The door shall be self-closing and provided with a spring-type lock arranged to permit the
18 door to be opened from inside of the pit without a key. Such doors shall be kept closed and
19 locked. A key shall be required to unlock the lock from outside the hoistway. The key shall be
20 of Group 1 Security (see 8.1).

21 (f) Separate pit access doors shall not be located where a person, upon entering the pit, can be
22 struck by any part of the car or counterweight when either is on its fully compressed buffer.

1 **2.2.4.6** Means to unlock the access door from inside the pit shall be provided. The means shall
2 be located

3 (a) when no pit ladder is provided, not more than 1 825 mm (72 in.) vertically above the pit
4 floor, or

5 (b) when a pit ladder is provided, not more than 1 825 mm (72 in.) vertically above a rung, cleat,
6 or step. The minimum distance from the top rung, cleat, or step to the top of the pit ladder or
7 handhold shall not be less than 1 200 mm (48 in.) (see 2.2.4.2.1 and Nonmandatory Appendix J,
8 Fig. J-1), and

9 (c) with the door in the closed position, in a plane not more than 1 000 mm (39 in.) horizontally
10 from a rung, cleat, or step of the pit ladder (see Nonmandatory Appendix J, Fig. J-1).

11 **3023.2 Access to underside of cars.** Access to the underside of cars shall comply with ASME
12 A17.1, 2.2.8 as amended below:

13 **2.2.8 Access to Underside of Car.** Where the distance from the pit floor to the underside of the
14 plank channels or slings exceeds 2 100 mm (83 in.), with the car at the lowest landing, a means
15 shall be permanently installed or permanently stored in the pit to provide access to the equipment
16 on the underside of the car. When access is provided by means of a working platform it shall
17 conform to the requirements of 2.7.5.3.2 through 2.7.5.3.6.

18 When working platform inspection operation is provided according to 2.7.5.3.6, in hoistways
19 containing a single elevator

20 (a) a pit access door is required, or

21 (b) an additional elevator personnel shall be present outside the hoistway when the pit inspection
22 operation is in effect.

1 completed and signed by the person performing the tests and shall identify the testing firm.

2 Copies of the completed forms shall be provided to the owner or to the owner's authorized agent.

3 SECTION 3027

4 ACCEPTANCE INSPECTIONS AND TESTS

5 **3027.1 Acceptance inspections and tests.** Inspections and tests shall comply with ASME
6 A17.1, 8.10, Acceptance Inspection and Tests, as amended below.

7 ASME 8.10.1 General Requirements for Acceptance Inspections and Tests

8 8.10.1.1 Persons Authorized to Make Acceptance Inspections and Tests

9 **8.10.1.1.1** The acceptance inspection shall be made by an inspector employed by the building
10 official (~~authority having jurisdiction, or by a person authorized by the authority having~~
11 ~~jurisdiction.~~)

12 **8.10.1.1.2** The person installing or altering the equipment shall perform all of the tests required
13 by ASME A17.1, 8.10.2 through 8.10.5 in the presence of the inspector specified in 8.10.1.1.1.

14 (~~8.10.1.1.3 The inspector shall meet the qualification requirements of the ASME QEI-1.~~
15 ~~Inspectors and inspection supervisors shall be certified by an independent, accredited, certifying~~
16 ~~organization as specified in 8.10.1.2 (see 1.3).)~~)

17 SECTION 3028

18 PERIODIC INSPECTIONS AND TESTS

19 **3028.1 Persons authorized to make periodic inspections and witness tests.** Periodic
20 inspection and tests shall comply with WAC 296-96-23600 as it existed on February 15, 2013
21 and ASME A17.1, 8.11 as amended below.

1 **8.11.1 General Requirements for Periodic Inspections and Witnessing of Tests**

2 ~~((8.11.1.1 Persons Authorized to Make Periodic Inspections and Witness Tests. The~~
3 ~~inspector shall meet the qualification requirements of the ASME QEI-1. Inspectors and~~
4 ~~inspection supervisors shall be certified an independent, accredited, certifying organization as~~
5 ~~specified in 8.10.1.2 (see 1.3).))~~

6 **8.11.1.1.1 Periodic Inspections**

7 (a) Periodic inspections shall be made by an inspector employed by the ((authority having
8 jurisdiction)) building official or by a person authorized by the ((authority having jurisdiction))
9 building official.

10 ~~((b) The inspector shall submit a signed written report to the authority having jurisdiction~~
11 ~~containing the following information:~~

12 ~~(1) date of inspection(s)~~

13 ~~(2) components or systems that have not been inspected~~

14 ~~(3) Code deficiencies noted during the inspection and a statement as to corrective action taken, if~~
15 ~~any))~~

16 **8.11.1.1.2 Periodic tests**

17 (a) Periodic tests as required in 8.6 shall be performed by elevator personnel that are qualified to
18 perform such tests. These tests shall be witnessed by an inspector (see 8.11.1.1) employed by the
19 ((authority having jurisdiction)) building official, or by persons authorized by the ((authority
20 having jurisdiction)) building official.

21 ~~((b) The inspector shall submit a signed written report to the authority having jurisdiction~~
22 ~~containing the following information:~~

23 ~~(1) date of inspection(s)~~

- 1 ~~(2) type of test(s) performed~~
2 ~~(3) detailed results of the test(s) including but not limited to, speed, governor trip speed, safety~~
3 ~~slide distance, relief valve setting, escalator/moving walk brake torque setting, etc.~~
4 ~~(4) Code deficiencies noted during the test~~
5 ~~(5) statement as to any corrective action taken))~~

6 **8.11.1.2 Applicability of Inspection Requirements.** Inspections required by 8.11.2 through
7 8.11.5 are to determine that the existing equipment conforms with the following applicable Code
8 requirements:

- 9 (a) the Code at the time of installation
10 (b) the Code effective as applicable to and for each alteration
11 ~~((c) the ASME A17.3 Code, if adopted by the authority having jurisdiction~~

12 NOTES (8.11.1.2):

- 13 ~~(1) The ASME A17.2 *Guide for Inspection of Elevators, Escalators, and Moving Walks* (see~~
14 ~~Preface, ASME Elevator Publications) is a guide for inspections.~~
15 ~~(2) References to “Items” of the ASME A17.2 *Guide for Inspection of Elevators, Escalators, and*~~
16 ~~*Moving Walks* and to the requirements of this Code are indicated in parentheses as a convenient~~
17 ~~reference to the applicable inspection procedures and requirements. It is important to understand~~
18 ~~that suggested test and inspection methodologies represent an approach but are neither exclusive~~
19 ~~nor comprehensive.~~

20 **8.11.1.3 Periodic Inspection and Test Frequency.** The equipment listed in Table 3028 shall be
21 inspected and tested at the intervals specified in Table 3028. ~~((The frequency of periodic~~
22 ~~inspections and tests shall be established by the authority having jurisdiction.))~~

1 NOTE: Recommended intervals for periodic inspections and tests can be found in
2 ((~~Nonmandatory Appendix N~~)) Table 3028.

3 **8.11.1.4 Installation Placed Out of Service.** Periodic inspections and tests shall not be
4 required when an installation is placed “out of service”:

5 (a) as defined by the ((~~authority having jurisdiction~~)) building official; or

6 (b) when an installation whose power feed lines have been disconnected from the mainline
7 disconnect switch; and

8 (1) an electric elevator, dumbwaiter, or material lift whose suspension ropes have been removed,
9 whose car and counterweight rest at the bottom of the hoistway, and whose hoistway doors have
10 been permanently barricaded or sealed in the closed position on the hoistway side;

11 (2) a hydraulic elevator, dumbwaiter, or material lift whose car rests at the bottom of the
12 hoistway; when provided with suspension ropes and counterweight, the suspension ropes have
13 been removed and the counterweight rests at the bottom of the hoistway; whose pressure piping
14 has been disassembled and a section removed from the premises and whose hoistway doors are
15 permanently barricaded or sealed in the closed position on the hoistway side; or

16 (3) an escalator or moving walk whose entrances have been permanently barricaded.

17 **8.11.1.5 Making Safety Devices Ineffective.** No person shall at any time make any required
18 safety device or electrical protective device ineffective, except where necessary during tests and
19 inspections. Such devices shall be restored to their normal operating condition in conformity
20 with the applicable requirements prior to returning the equipment to service (see 2.26.7).

21 **8.11.1.7 Unique or Product-Specific Procedures or Methods.** Where unique or product-
22 specific procedures or methods are required to maintain, repair, replace, inspect or test
23 equipment, such procedures or methods shall be provided by the manufacturer or installer. These

1 procedures and any unique devices required by the procedures for inspection and testing shall be
2 accessible on site to elevator personnel [see 8.6.1.2.2(b)].

3 **3028.2 Category Five tests.** Elevators shall be subject to five-year inspection test requirements
4 in accordance with Table 3028, Periodic Test Requirements – Category Five, except that safety
5 and governor systems of cars operating on wood guide rails shall be tested by tripping the
6 governor by hand with rated load in the car, and the car at rest.

7 All Category Five tests shall comply with ASME A17.1, 8.6 as amended below:

8 **ASME 8.6.4.20 Periodic Test Requirements – Category 5.**

9 NOTE: For test frequency, see 8.11.1.3.

10 **8.6.4.20.1 Car and Counterweight Safeties.** Types A, B, and C car and counterweight
11 safeties shall be tested in accordance with 8.6.4.20.1(a) (~~or subject to approval by the~~
12 ~~authority having jurisdiction with 8.6.4.20.1(b))~~).

13 *(a) Rated Load and Rated Speed Test.* Car safeties, except those operating on wood guide
14 rails, and their governors, shall be tested with rated load in the car. Counterweight safety tests
15 shall be made with no load in the car. Tests shall be made by tripping the governor by hand at
16 the rated speed. The following operational conditions shall be checked (Item 2.29.2):

17 *(1)* Type B safeties shall stop the car with the rated load within the required range of
18 stopping distances for which the governor is tripped (Item 2.29.2) and the level of the
19 platform checked for conformance to 2.17.9.2.

20 *(2)* For Type A safeties and Type A safety parts of Type C safeties, there shall be
21 sufficient travel of the safety rollers or dogs remaining after the test to bring the car and
22 its rated load to rest on safety application at governor tripping speed. The level of the
23 platform shall be checked for conformance to 2.17.9.2.

1 ~~((b) Alternative Test Method for Car Safeties. The alternative test methods shall comply~~
2 ~~with 8.6.11.10 and the following:~~

3 ~~(1) The testing of safeties with any load in the car, centered on each quarter of the~~
4 ~~platform symmetrically with relation to the centerlines of the platform from no load up to~~
5 ~~rated load, and at not less than rated speed shall be permitted provided that~~

6 ~~(a) when the alternative test is performed, the test shall stop the car and verify that~~
7 ~~the safeties will be capable of stopping an overspeeding car in accordance with the~~
8 ~~requirements of Section 2.17 applicable to the specific classification of safeties, and~~

9 ~~(b) when applied, the method shall verify that the safeties perform or are capable~~
10 ~~of performing in compliance with 8.6.4.20.1(a) and the platform shall not be out of~~
11 ~~level more than 30 mm/m (0.36 in./ft) in any direction.)~~

12 ~~(2) A test tag as required in 8.6.1.7.2 shall be provided.~~

13 **8.6.4.20.2 Governors**

14 ~~(a) The tripping speed of the governor and the speed at which the governor~~
15 ~~overspeed switch, where provided, operates shall be tested to determine conformance~~
16 ~~with the applicable requirements and the adjustable means shall be sealed (Item~~
17 ~~2.13.2.1).~~

18 ~~(b) The governor rope pull-through and pull-out forces shall be tested to~~
19 ~~determine conformance with the applicable requirements, and the adjustment means~~
20 ~~shall be sealed (Item 2.13.2.1).~~

21 ~~(c) After these tests ((in jurisdictions enforcing NBCC)), a metal tag indicating~~
22 ~~the date of the governor tests, together with the name of the person or firm that~~
23 ~~performed the tests, shall be attached to the governor in a permanent manner.~~

1 **8.6.4.20.3 Oil Buffers**

2 (a) Car oil buffers shall be tested to determine conformance with the applicable
3 requirements by

4 (1) running the car onto the buffer with rated load at rated speed, ((or
5 ~~(2) subject to approval by the authority having jurisdiction~~

6 ~~(a) running the car with any load, from no load up to rated load onto the~~
7 ~~buffer at rated speed when the requirements of 8.6.11.10 are complied with,~~
8 ~~provided that when applied the method verifies that the buffer performs or is~~
9 ~~capable of performing in compliance with 8.6.4.20.3(a), except as specified in~~
10 ~~8.6.4.20.3(b) and (c) (Item 5.9.2.1). Counterweight oil buffers shall be tested~~
11 ~~by running the counterweight onto its buffer at rated speed with no load in the~~
12 ~~car, except as specified in 8.6.4.20.3(b) and (c) (Item 5.9.2.1), or~~

13 ~~(b) running the car onto the buffer with any load, from no load up to rated~~
14 ~~load, and at less than rated speed, when the requirements of 8.6.11.10 are~~
15 ~~complied with, provided that when applied, the method verifies that the buffer~~
16 ~~performs or is capable of performing in compliance with 8.6.4.20.3(a))~~

17 (b) For reduced stroke buffers, this test shall be made at the reduced striking speed
18 permitted (Item 5.9.2.1).

19 (c) This test is not required where a Type C safety is used (see 8.6.4.20.1).

20 (d) In making these tests, the normal and emergency terminal stopping devices
21 shall be made temporarily inoperative. The final terminal stopping devices shall
22 remain operative and be temporarily relocated, if necessary, to permit compression of
23 the buffer during the test.

1 (e) After completion of the test, a metal tag, indicating the date of the test,
2 together with the name of the person or firm who performed the test, shall be attached
3 to the buffer [Item 5.3.2(b)].

4 (f) Counterweight oil buffers shall be tested by running the counterweight onto its
5 buffer at rated speed with no load in the car, except as specified in 8.6.4.20.3(b) and
6 (c) (Item 5.9.2.1), or at reduced speed if the requirements of 8.6.11.10 are met.

7 (g) A test tag as required in 8.6.1.7.2 shall be provided.

8 **8.6.4.20.4 Driving-Machine Brake(s).** For passenger elevators and all freight
9 elevators, the driving-machine brake shall be tested for compliance with applicable
10 requirements, in accordance with 8.6.4.20.4(a), ~~((or subject to approval by the~~
11 ~~authority having jurisdiction with 8.6.4.20.4(b).))~~

12 For elevators installed under ASME A17.1-2000/ CSA B44-00 and later editions,
13 have the brake setting verified in accordance with the data on the brake marking
14 plate.

15 Upon completion of the test, the means of adjusting the holding capacity shall be
16 sealed to prevent changing the adjustment without breaking the seal. The seal shall
17 bear or otherwise attach the identification of the person or firm that installed it. (See
18 also 8.6.1.7.2, Periodic Test Tags.)

19 (a) Test with load per Table 8.6.4.20.4. Place the load as shown in Table
20 8.6.4.20.4 in the car. The driving-machine brake, on its own, shall hold the car with
21 this load. With no load in the car the driving-machine brake shall hold the empty car
22 at rest, and shall decelerate an empty car traveling in the up direction from governor
23 tripping speed. The driving-machine brake on freight elevators of Class C-2 loading,

1 when loaded to their maximum design load, shall hold the elevator car at rest (Item
2 2.17.2.1).

3 ~~((b) Alternative Test Method for Driving Machine Brakes. The alternative test
4 methods shall comply with 8.6.11.10 and the following:~~

5 ~~(1) Any method of verifying conformity of the driving machine brake with the
6 applicable Code requirements (see 2.24.8.3 and Table 8.6.4.20.4) shall be
7 permitted, including the testing method of the brakes with or without any load in
8 the car, provided that when applied the method verifies that the brake performs or
9 is capable of performing in compliance with 8.6.4.20.4(a).)~~

10 ~~(2) A test tag as required in 8.6.1.7.2 shall be provided.~~

11 ~~((8.6.11.10 Category 5 Tests Without Load Via Alternative Test Methodologies~~

12 ~~**8.6.11.10.1 Where Permitted.** Alternative test methods without load are permitted for
13 Category 5 testing subject to approval by the authority having jurisdiction of~~

14 ~~(a) car and counterweight safeties per 8.6.4.20.1~~

15 ~~(b) oil buffers per 8.6.4.20.3~~

16 ~~(c) driving machine brakes per 8.6.4.20.4, and~~

17 ~~(d) braking system, traction, and traction limits per 8.6.4.20.10~~

18 NOTE: See 8.10, Note (2).

19 ~~**8.6.11.10.2 Alternative Test Method and Tools**~~

20 ~~(a) An alternative test method shall be~~

21 ~~(1) based on sound engineering principles~~

22 ~~(2) validated and documented via engineering tests~~

1 ~~(b) The method, measuring devices, and tools shall be capable of producing reliable and~~
2 ~~consistent measurements, suitable for the intended measurement. The monitoring and~~
3 ~~calibration of the measuring devices or tools shall be in accordance with the provider's~~
4 ~~guidelines.~~

5 **8.6.11.10.3 Alternative Test Method Procedure.**

6 The alternative test method shall

7 ~~(a) include requirements to obtain and verify car and counterweight masses if necessary for~~
8 ~~the test~~

9 ~~(b) have a procedure document that~~

10 ~~(1) defines the permissible equipment range and limitations regarding use~~

11 ~~(2) establishes monitoring and calibration criteria for tools or measuring devices as~~
12 ~~appropriate~~

13 ~~(3) defines the test set-up procedure~~

14 ~~(4) provides instructions on how to interpret results and correlate the results to pass-fail~~
15 ~~criteria~~

16 ~~(c) describe how to correlate no load test results with previously acquired full load and no~~
17 ~~load results~~

18 ~~(d) be included in the maintenance control program [see 8.6.1.2.1(a)]~~

19 ~~(e) include the information required by 8.6.1.2.1(f) where applicable, and~~

20 ~~(f) require a report conforming to 8.6.11.10.4.~~

21 **8.6.11.10.4 Alternative Test Method Report.** The alternative test method report shall

22 ~~(a) identify the alternative test tool (make/model) used to perform the test~~

1 ~~(b) identify the company performing the tests, names of personnel conducting and~~
2 ~~witnessing the tests, and testing dates~~

3 ~~(c) contain all required printouts or record of tests required to demonstrate compliance to the~~
4 ~~testing requirement that were gathered during an acceptance test~~

5 ~~(d) identify which results from the baseline test are to be used for future compliance~~
6 ~~evaluation~~

7 ~~(e) record the car and counterweight masses that were obtained per 8.6.11.10.3(a) during the~~
8 ~~acceptance test and during any subsequent Category 5 test if required by test method~~

9 ~~(f) contain all subsequent Category 5 results with pass-fail conclusions regarding Code~~
10 ~~compliance~~

11 ~~(g) remain on site or shall be available to elevator personnel and the authority having~~
12 ~~jurisdiction.)~~

13 **3028.3 Cleaning and testing of escalators and moving walks.** In addition to the periodic
14 inspection and tests specified in Table 3028, escalator and moving walk trusses and pans shall be
15 cleaned every 12 months.

16 **3028.4 Step/skirt test.** The step/skirt performance index test specified in 8.6.8.15.19 is required
17 for all periodic escalator tests at intervals specified in Table 3028. Escalator and moving walk
18 step/skirt shall be performed every 12 months.

Table 3028 Inspection and Test Intervals

Note: Intervals are specified in months; sections reference ASME A17.1 unless otherwise specified

| Section | Equipment Type | Periodic Tests | | | | | | | | | |
|---------------------|--|-----------------------|----------|-----------------------|----------|----------------|----------|-----------------------|----------|-------------|----------|
| | | Periodic Inspections | | Category One | | Category Three | | Category Five | | Other | |
| | | Requirement | Interval | Requirement | Interval | Requirement | Interval | Requirement | Interval | Requirement | Interval |
| 8.11.2 | Electric elevators | 8.11.2.1 | 12 | 8.6.4.19 | 12 | N/A | N/A | 8.6.4.20 | 60 | | |
| 8.11.3 | Hydraulic elevators | 8.11.3.1 | 12 | 8.6.5.14 | 12 | 8.6.5.15 | 36 | 8.6.5.16 | 60 | | |
| 8.11.4; SBC 3028 | Escalators & moving walks | 8.11.4.1 | 12 | 8.6.8.15 | 12 | N/A | N/A | N/A | N/A | SBC 3028 | 12 |
| 8.11.5.3 | Hand elevators | 8.11.2.1 | 12 | 8.6.4.19 | 12 | N/A | N/A | 8.6.4.20, 8.6.5.16 | 60 | | |
| 8.11.5.4 | Dumbwaiters | 8.11.2.1, 8.11.3.1 | 12 | 8.6.4.19, 8.6.5.14 | 12 | 8.6.5.15 | 36 | 8.6.4.20, 8.6.5.16 | 60 | | |
| 8.11.5.5 | Material lifts and dumbwaiters with automatic transfer devices | 8.11.2.1, 8.11.3.1 | 12 | 8.6.4.19, 8.6.5.14 | 12 | 8.6.5.15 | | 8.6.4.20, 8.6.5.16 | 60 | | |
| 8.11.5.6 | Special purpose personnel elevators | 8.11.2.1, 8.11.3.1 | 12 | 8.6.4.19, 8.6.5.14 | 12 | 8.6.5.15 | | 8.6.4.20, 8.6.5.16 | 60 | | |
| 8.11.5.7 | Inclined elevators | 8.11.2.1, 8.11.3.1 | 12 | 8.6.4.19, 8.6.5.14 | 12 | 8.6.5.15 | | 8.6.4.20, 8.6.5.16 | 60 | | |
| 8.11.5.9 | Screw-column elevators | 8.11.2.1, 8.11.3.1 | 12 | 8.6.4.19, 8.6.5.14 | 12 | 8.6.5.15 | | 8.6.4.20, 8.6.5.16 | 60 | | |
| 8.11.5.10 | Rooftop elevators | 8.11.2.1, 8.11.3.1 | 12 | 8.6.4.19, 8.6.5.14 | 12 | 8.6.5.15 | | 8.6.4.20, 8.6.5.16 | 60 | | |
| 8.11.5.11 | Rack & pinion elevators | 8.11.2.1, 8.11.3.1 | 12 | 8.6.4.19, 8.6.5.14 | 12 | 8.6.5.15 | | 8.6.4.20, 8.6.5.16 | 60 | | |
| 8.11.5.12 | Limited use/limited application elevators | 8.11.2.1, 8.11.3.1 | 12 | 8.6.4.19, 8.6.5.14 | 12 | 8.6.5.15 | | 8.6.4.20, 8.6.5.16 | 60 | | |

1 necessary for test (see 2.7.4). The instructions shall be permanently legible with characters a
2 minimum of 3 mm (0.125 in.) in height.)) The MCP shall be posted in the machine room,
3 machinery place or control room.

4 (e) The specified scheduled maintenance intervals (see 1.3) shall, as applicable, be based
5 on

6 (1) equipment age, condition, and accumulated wear

7 (2) design and inherent quality of the equipment

8 (3) usage

9 (4) environmental conditions

10 (5) improved technology

11 (6) the manufacturer's recommendations and original equipment certification for any SIL
12 rated devices or circuits (see 8.6.3.12 and 8.7.1.9)

13 (7) the manufacturer's recommendations based on any ASME A17.7/CSA B44.7
14 approved components or functions

15 (f) Procedures for tests; periodic inspections; maintenance; replacements; adjustments;
16 and repairs for traction-loss detection means, broken-suspension-member detection means,
17 residual-strength detection means, and related circuits shall be incorporated into the made
18 part of the Maintenance Control Program. [See 2.20.8.1, 2.20.8.2, 2.20.8.3, ~~8.6.11.10,~~
19 ~~8.10.2.2.2(cc)(3)(e)(2);~~) 8.10.2.2.2(ss), and 8.6.4.19.12(b).]

20 **8.6.1.2.2 On-Site Documentation.** The following documents specified in 8.6.1.2.2(a),
21 (b), and (c) shall be written and permanently kept on-site in the machine room, machinery space,
22 control room, ~~((control space, or the means necessary for test (2.7.6.4)))~~ in hard copy for each
23 unit for elevator personnel.

1 The documentation specified in 8.6.1.2.2(d) shall be on-site and available to the specified
2 personnel.

3 (a) Up-to-date wiring diagrams detailing circuits of all electrical protective devices (see
4 2.26.2) and critical operating circuits (see 2.26.3).

5 (b) Procedures for inspections and tests not described in ASME A17.2 and procedures or
6 methods required for elevator personnel to perform maintenance, repairs, replacements,
7 and adjustments, as follows:

8 (1) all procedures specifically identified in the Code as required to be written (e.g.,
9 8.6.4.20.8, check out procedure for leveling; 8.6.5.16.5, check out procedure for
10 overspeed valve; and 8.6.8.15.7, check out procedure for reversal stop switch,
11 etc.)

12 (2) unique maintenance procedures or methods required for inspection, tests, and
13 replacement of SIL rated E/E/PES electrical protective devices and circuits. See
14 2.26.4.3.2, 2.26.9.3.2(b), 1.2.26.9.5.1(b), and 2.26.9.6.1(b)

15 (3) unique maintenance procedures or methods required for inspection, tests, and
16 replacement of equipment applied under alternative arrangements (see 1.2.2.1)
17 shall be provided by the manufacturer or installer

18 (4) unique maintenance procedures or unique methods required for inspection and
19 test of equipment specified in an ASME A17.7/CSA B44.7, Code Compliance
20 Document (CCD)

21 (c) Written checkout procedures

22 (1) to demonstrate E/E/PES function as intended (see 8.6.4.19.10)

23 (2) for elevator leveling speed with open doors (see 8.6.4.20.8)

1 (3) for hydraulic elevator overspeed valve (see 8.6.5.16.5)

2 (4) for escalator reversal stopping device (see 8.6.8.15.7)

3 (5) for escalator handrail retarding force (see 8.6.8.15.13)

4 (d) Written procedures for the following:

5 (1) Evacuation procedures for elevators by authorized persons and emergency
6 personnel shall be available on-site (see 8.6.11.5.2 and ASME A17.4)

7 (2) the procedure for cleaning of a car and hoistway transparent enclosures by
8 authorized persons (see 8.6.11.4.2)

9 **8.6.1.3 Maintenance Personnel.** Maintenance, repairs, replacements, and tests shall be
10 performed only by elevator personnel (see 1.3)

11 **8.6.1.4 Maintenance Records.** Maintenance records shall document compliance with
12 8.6. Instructions for locating the maintenance records of each unit, for viewing on-site, shall
13 be posted on the controller or at the means necessary for test (see 2.7.6.4). The provided
14 instructions shall be permanently legible with characters a minimum of 3 mm (0.125 in.) in
15 height. These records shall be retained for the most recent 5 yr or from the date of installation
16 or adoption of this Code edition, whichever is less or as specified by the authority having
17 jurisdiction. Existing maintenance records up to 5 yr shall be retained.

18 **8.6.1.4.1 On-Site Maintenance Records**

19 *(a) Maintenance Control Program Records*

20 (1) A record that shall include the maintenance tasks listed with the associated
21 requirements of 8.6 identified in the Maintenance Control Program (8.6.1.2.1), other tests
22 (see 8.6.1.2.2), examinations and adjustments, and the specified scheduled intervals shall be
23 maintained.

1 (2) The specified scheduled maintenance intervals (see 1.3) shall, as applicable, be based
2 on the criteria given in 8.6.1.2.1(e).

3 (3) MCP records shall be viewable on-site by elevator personnel in either hard copy or
4 electronic format acceptable to the authority having jurisdiction and shall include but not
5 limited to the following:

6 (a) site name and address

7 (b) service provider name

8 (c) conveyance identification (I.D.) and type

9 (d) date of record

10 (e) a description of the maintenance task, interval, and associated requirements of

11 8.6

12 (f) indication of completion of maintenance task

13 NOTE: [8.6.1.4.1(a)]: Recommended format for documenting Maintenance Control Program
14 records can be found in Nonmandatory Appendix Y. This is only an example format. A specific
15 maintenance control program that includes all maintenance needs is required for each unit.

16 (b) *Repair and Replacement Records*. The following repairs and replacements shall be
17 recorded and shall be kept on-site for viewing by elevator personnel in ~~((either))~~ hard copy.
18 Records in electronic format may be provided if approved by the building official. ~~((or electronic~~
19 ~~format. Instructions for locating the records of each unit for immediate viewing shall be posted~~
20 ~~on the controller or at the means necessary for test (see 2.7.6.4).))~~ The provided instructions shall
21 be permanently legible with characters a minimum of 3 mm (0.125 in) in height. The record shall
22 include an explanation of the repair or replacement, date, and name of person(s) and/or firm
23 performing the task. The record of repairs and replacements shall be retained by the owner of the

1 equipment for the most recent 5 yr or from the date of installation or adoption of this Code
2 edition, whichever is less or as specified by the authority having jurisdiction and shall be a
3 permanent record for the installation. ~~((These records may be kept remotely from the site.))~~

4 (1) Repairs (8.6.2.1 through 8.6.2.5) including repairs of components and devices
5 listed in 8.6.4, 8.6.5, 8.6.6, 8.6.7, 8.6.8, 8.6.9, and 8.6.10.

6 (2) Replacements (8.6.3.1 through 8.6.3.11 except 8.6.3.7 and 8.6.3.10) including
7 replacements of components and devices listed in 8.6.4, 8.6.5, 8.6.6, 8.6.7, 8.6.8, 8.6.9, and
8 8.6.10.

9 (c) *Other Records.* The following written records shall be kept on-site for each unit.
10 Instruction for locating the records of each unit for immediate viewing shall be posted on the
11 controller or at the means necessary for test (see 2.7.6.4). The provided instructions shall be
12 permanently legible with characters a minimum of 3 mm (0.125 in.) in height. These records
13 shall be retained for the most recent 5 yr from of the date of installation or adoption of this Code
14 edition, whichever is less or as specified by the authority having jurisdiction. The record shall
15 include the date and name of person(s) and/or firm performing the task.

16 (1) A record of oil usage (8.6.5.7).

17 (2) A record of findings for firefighters' service operation required by 8.6.11.1
18 with identification of the person(s) that performed the operation.

19 (3) Periodic tests (see 8.6.1.7) shall be documented or recorded in accordance
20 with 8.6.1.7.2.

21 (4) Written record to document compliance with replacement criteria specified in
22 ASME A17.6 requirement 1.10.1.1(c).

1 (d) *Permanent Record*. A permanent record of the results of all acceptance tests as
2 required by 8.10.1.1.4 and 8.10.1.1.5 shall be kept with the on-site records.

3 Test tags, complying with 2.16.3.3 for marking plates (except lettering shall be 1.6 mm
4 [0.0625 in]), permanently attached to or adjacent to the controller, shall meet this requirement.

5 NOTE: This requirement does not apply to equipment installed under ASME A17.1-2010 and
6 earlier editions.

7 **8.6.1.4.2 Call Backs (Trouble Calls)**. A record of call backs shall be maintained and shall
8 include the description of reported troubles, dates, time, and corrective action(s) taken that are
9 reported by any means to elevator personnel. These records shall be made available to elevator
10 personnel when performing corrective action. For elevator personnel other than personnel
11 performing the corrective action, records will be available upon request. Instructions on how to
12 report any need for corrective action (trouble calls) to the responsible party shall be posted on the
13 controller or at the means necessary for test (see 2.7.6.4). The instructions shall be permanently
14 legible with characters a minimum of 3 mm (0.125 in.) in height.

15 **3029.2 Remote Monitoring and Operation** Elevators and other conveyances found operating
16 with a device that can directly effect a change in its controls from a remote location is prohibited
17 unless it is operated under the direct on-site supervision of a person who is a licensed elevator
18 mechanic in accordance with Section 3003.2.

19 NOTE: Remote operation controls, operated by building personnel located within the building,
20 may be installed for security purposes upon prior approval of the *building official*.

21 Section 26. The following sections of Chapter 31 of the International Building Code,
22 2015 Edition, are amended as follows:

1
2 **CHAPTER 31**

3 **SPECIAL CONSTRUCTION**

4 ***

5 **SECTION 3102**

6 **MEMBRANE STRUCTURES**

7 ***

8 **3102.8.2 Legally required ((Standby)) standby power system.** Wherever an auxiliary
9 inflation system is required, an *approved legally required standby power ((generating))*
10 system shall be provided. The system shall be equipped with a suitable means for
11 automatically starting the generator set upon failure of the normal electrical service and for
12 automatic transfer and operation of all of the required electrical functions at full power within
13 60 seconds of such service failure. The legally required ((S))standby power system shall be
14 capable of operating independently for not less than 4 hours.

15 ***

16 **SECTION 3103**

17 **TEMPORARY STRUCTURES**

18 **3103.1 See Section 106.13. ((General.** The provisions of Sections 3103.1 through 3103.4 shall
19 apply to structures erected for a period of less than 180 days. Tents and other membrane
20 structures erected for a period of less than 180 days shall comply with the *International Fire*
21 *Code.* Those erected for a longer period of time shall comply with applicable sections of this
 code.

1 ~~**3103.1.1 Conformance.** Temporary structures and uses shall conform to the structural~~
2 ~~strength, fire safety, *means of egress*, accessibility, light, ventilation and sanitary~~
3 ~~requirements of this code as necessary to ensure public health, safety and general welfare.~~

4 ~~**3103.1.2 Permit required.** Temporary structures that cover an area greater than 120~~
5 ~~square feet (11.16 m²), including connecting areas or spaces with a common *means of*~~
6 ~~*egress* or entrance that are used or intended to be used for the gathering together of 10 or~~
7 ~~more persons, shall not be erected, operated or maintained for any purpose without~~
8 ~~obtaining a *permit* from the *building official*.~~

9 ~~**3103.2 Construction documents.** A *permit* application and *construction documents* shall be~~
10 ~~submitted for each installation of a temporary structure. The *construction documents* shall~~
11 ~~include a site plan indicating the location of the temporary structure and information~~
12 ~~delineating the *means of egress* and the *occupant load*.~~

13 ~~**3103.3 Location.** Temporary structures shall be located in accordance with the requirements~~
14 ~~of Table 602 based on the *fire-resistance rating* of the *exterior walls* for the proposed type of~~
15 ~~construction.~~

16 ~~**3103.4 Means of egress.** Temporary structures shall conform to the *means of egress*~~
17 ~~requirements of Chapter 10 and shall have an *exit access* travel distance of 100 feet (30 480~~
18 ~~mm) or less.))~~

SECTION 3104

PEDESTRIAN WALKWAYS AND TUNNELS

22 **3104.6 Public way.** *Pedestrian walkways* over a *public way* shall comply with Chapter 32
23 and the Street Use Ordinance, *Seattle Municipal Code* Title 15.

SECTION 3105

AWNINGS AND CANOPIES

~~((3105.1 General. Awnings and canopies shall comply with the requirements of Sections 3105.2 through 3105.4 and other applicable sections of this code.~~

~~3105.2 Definition. The following term is defined in Chapter 2:~~

~~RETRACTABLE AWNING.~~

~~3105.3 Design and construction. Awnings and canopies shall be designed and constructed to withstand wind or other lateral loads and live loads as required by Chapter 16 with due allowance for shape, open construction and similar features that relieve the pressures or loads. Structural members shall be protected to prevent deterioration. Awnings shall have frames of noncombustible material, fire-retardant treated wood, wood of Type IV size, or 1-hour construction with combustible or noncombustible covers and shall be either fixed, retractable, folding or collapsible.~~

~~3105.4 Awnings and canopy materials. Awnings and canopies shall be provided with an approved covering that meets the fire propagation performance criteria of Test Method 1 or Test Method 2, as appropriate, of NFPA 701 or has a flame spread index not greater than 25 when tested in accordance with ASTM E 84 or UL 723.~~

~~**Exception:** The fire propagation performance and flame spread index requirements shall not apply to awnings installed on detached one and two family dwellings.))~~

3105.1 General. All awnings and canopies are subject to the requirements of this section. A marquee is a type of canopy and is subject to this section. Awnings and canopies containing electrical wiring and light fixtures are also subject to the requirements of the *Seattle Electrical*

1 Code. Awnings and canopies over a public place shall comply with the *Seattle Municipal Code*
2 Title 15, *Street Use Code*.

3 **3105.2 Definitions.** The following terms are defined in Chapter 2 of this code.

4 **AWNING.**

5 **AWNING SIGN.**

6 **CANOPY.**

7 **CANOPY SIGN.**

8 **DISPLAY SURFACE.**

9 **FIRE-RETARDANT COVERING.**

10 **VENEER.**

11 **3105.2.1 Definitions of “sign” and various types of signs are found in *Seattle Municipal***
12 **Code, Title 23, *Land Use Code*, Chapter 84A, Definitions.**

13 **3105.3 Permits.**

14 **3105.3.1 Permits required.** No awning or canopy shall be erected, constructed, altered or
15 structurally revised without a permit issued by the *building official*. A single permit may be
16 issued for installation of all awnings or canopies, without signs, serving a multi-tenant
17 building. Structural repairs and replacement of awning coverings requires a permit.

18 Signs installed on awnings and canopies shall have a separate sign permit for each
19 separate business entity.

20 Each subsequent installation of an awning, canopy or sign shall require a separate permit.

21 **Exception:** Maintenance which is limited to painting, repainting, cleaning and minor
22 repairs does not require a permit.

1 **3105.3.2 Permit application.** To obtain a permit required by this chapter, the applicant shall
2 file an application which includes the following:

3 1. The address of the proposed awning or canopy on the building;

4 2. Specifications, plans and drawings of the structure, site and vicinity plans, and an
5 identification numbering system for the placement of each proposed *awning* or *canopy* on
6 the elevation and plan view drawings;

7 3. Signature, contact information and City business license number of the building owner;

8 4. Signature, contact information and City business license number of the business
9 establishment served by the awning or canopy;

10 5. Signature, contact information, City business license number, and State contractor or
11 electrical contractor license number of the installer;

12 6. Electrical connection and illumination information when the awning or canopy has
13 electrical components; and

14 7. Permit fee as specified in the Fee Subtitle.

15 **3105.4 Maintenance.** Each awning and canopy, together with their supports, braces, anchors,
16 and signs shall be maintained in good repair and in a proper state of preservation. The surface of
17 all awnings and canopies shall be kept clean and awnings shall be protected with a sealer-type
18 solution. Failure to maintain any awning, canopy or sign is a violation and subject to the
19 provisions of Section 103 of this code.

20 **3105.5 Materials.** Awnings shall have approved *fire-retardant coverings* or shall comply with
21 the requirements in this code for the materials used. Canopy materials shall meet the standards
22 for the rigid material used as required by this code. Frames shall be of materials allowed for the
23 type of construction of the building.

1 **Exception:** Aluminum frames are allowed with all construction types.

2 **3105.5.1 Approval of materials.** The building official is permitted to require that sufficient
3 technical data be submitted to substantiate the proposed use of any materials and is allowed
4 to approve their use if it is determined that the evidence submitted is satisfactory for the use
5 intended.

6 **3105.6 Welding.** All structural welding shall conform to the requirements of Chapter 20 for
7 aluminum and Chapter 22 for steel.

8 **3105.7 Electric signs and luminaires.** All electric signs shall comply with *Seattle Electrical*
9 Code Article 600 and Article 410 for luminaires.

10 **3105.8 Obstruction of exits, light and ventilation.** No portion of the surface or support of an
11 awning or canopy, including a retracted awning, shall be erected, constructed or maintained so as
12 to obstruct any fire escape or standpipe, or any window, door or opening used as a *means of*
13 *egress*, or so as to prevent free passage from one part of a roof to any other part of a roof. No
14 awning, canopy, or portion thereof shall be attached in any form, shape or manner to a fire
15 escape or standpipe, nor be placed in any manner that interferes with any opening providing
16 ventilation or light required by Chapter 12 of this *Code*.

17 **3105.9 Location.** All portions of awnings and canopies shall be at least 8 feet (2438 mm) above
18 any walking surface immediately below. All portions of awnings and canopies located over
19 public property shall be at least 8 feet (2438 mm) above grade and at least 2 feet (610 mm) from
20 the curb. Awnings and canopies shall be located where they will not obstruct, obscure or interfere
21 with any publicly maintained street tree, streetlight or utility pole.

22 **3105.10 Supports.** The supports for awnings and canopies shall be located on private property.

1 **Exception:** Where approved by the Director of Transportation, stanchions for awnings
2 located at the entrance to buildings are permitted to be installed on public property if they are
3 located in line with other street furniture. Individual stanchions shall have a cross sectional
4 dimension or diameter no greater than 6 inches (152 mm).

5 **3105.11 Drainage.**

6 **3105.11.1 Awning drainage.** Awnings shall shed water uniformly from the awning covering.

7 **3105.11.2 Canopy drainage.** Canopies draining away from the building line shall shed water
8 uniformly over the canopy edge. The upper surface of a canopy shall be sloped a minimum of
9 1 unit vertical in 48 units horizontal (2% slope). Approval shall be obtained from the Director
10 of Public Utilities when a canopy drains back toward the building and is connected to an
11 infiltration facility, a side sewer or is conveyed under a sidewalk to a gutter.

12 **3105.12 Design loads.** Awnings and canopies shall be designed and constructed to resist all
13 forces to which they are subject as specified in Chapter 16. Where signs, electric signs or
14 luminaires are attached to an awning or canopy structure, the additional load of all attachments
15 shall be included in the design loads and shall comply with the requirements of Chapter 16 and
16 Section 3107.10.1 of this Code.

17 **3105.13 Pitch.** The upper surface of all awnings shall have a pitch of at least 30 degrees (0.52
18 rad) from the horizontal. The *building official* is authorized to approve awnings with a smaller
19 pitch when the design is prepared by a licensed structural engineer.

20 **3105.14 Attachment of awnings and canopies.** All awnings and canopies attached to masonry,
21 concrete, aluminum, or steel shall be safely secured with steel anchors and bolts, or approved
22 expansion bolts of sufficient size and anchorage to support the loads safely. No support or

1 attachment for an awning or canopy shall be connected to, supported by, or fastened to exterior
2 vener.

3 **3105.15 Size.** Where an awning or canopy is located at an exit door from a stairway or exit
4 passageway that is fire-resistance rated, the distance the awning or canopy projects from the
5 building shall be no more than one-half the distance from the walking surface to the lowest point
6 of the bottom of the awning or canopy.

7 **3105.16 Approved materials.** The *building official* may require that sufficient technical data be
8 submitted to substantiate the proposed use of any material; and may approve use of the material
9 if the *building official* determined that the evidence submitted is satisfactory for the intended use.

10 **3105.17 Inspections.** All *awnings* and *canopies* regulated by this chapter are subject to
11 inspection by the *building official*. The permit holder must request a final inspection within 3
12 business days of completing the installation.

13 **3105.18 Footing or foundation inspection.** Footings or foundations for *awnings* and *canopies*
14 are subject to inspection by the *building official*. An inspection must be requested and completed
15 before the footing is filled.

16 **3105.19 Electrical inspection.** All electrical wiring is subject to the *Seattle Electrical Code*.
17 Upon energizing any electrical elements, the permit holder must request an inspection within one
18 business day.

SECTION 3106

MARQUEES

21 **3106.1 General.** Marquees are, by definition, a canopy and shall comply with Section 3105.
22 ~~((Marquees shall comply with Sections 3106.2 through 3106.5 and other applicable sections of~~
23 ~~this code.~~

1 ~~**3106.2 Thickness.** The height or thickness of a marquee measured vertically from its lowest to~~
2 ~~its highest point shall be not greater than 3 feet (914 mm) where the marquee projects more than~~
3 ~~two-thirds of the distance from the *lot line* to the curb line, and shall be not greater than 9 feet~~
4 ~~(2743 mm) where the marquee is less than two-thirds of the distance from the lot line to the curb~~
5 ~~line.~~

6 ~~**3106.3 Roof construction.** Where the roof or any part thereof is a skylight, the skylight shall~~
7 ~~comply with the requirements of Chapter 24. Every roof and skylight of a marquee shall be~~
8 ~~sloped to downspouts that shall conduct any drainage from the marquee in such a manner so as~~
9 ~~not to spill over the sidewalk.~~

10 ~~**3106.4 Location prohibited.** Every marquee shall be so located as not to interfere with the~~
11 ~~operation of any exterior standpipe, and such that the marquee does not obstruct the clear~~
12 ~~passage of *stairways* or *exit discharge* from the building or the installation or maintenance of~~
13 ~~street lighting.~~

14 ~~**3106.5 Construction.** A marquee shall be supported entirely from the building and constructed~~
15 ~~of noncombustible materials. Marquees shall be designed as required in Chapter 16. Structural~~
16 ~~members shall be protected to prevent deterioration.))~~

SECTION 3107

SIGNS

17
18
19 ~~((**3107.1 General.** Signs shall be designed, constructed and maintained in accordance with this~~
20 ~~code.))~~

21 **3107.1 General.** It is the purpose of this chapter to safeguard the life, health, property and
22 welfare of people within the City by regulating and controlling the design, quality of materials,

1 construction, location, illumination, and maintenance of signs and sign structures that are visible
2 from any portion of public places and rights-of-way.

3 **3107.2 Enforcement.**

4 **3107.2.1 Authority.** The Director of Transportation and the *building official* shall enforce the
5 provisions of this chapter as it relates to signs located over public places. “Public places” is
6 defined in Section 15.02.046 of the *Seattle Municipal Code, Street and Sidewalk Use*. The
7 *building official* shall enforce the provisions of this chapter as it relates to signs located over
8 all other property in the City of Seattle.

9 **3107.2.2 Other requirements.** All signs shall comply with any additional sign regulations
10 imposed by *Seattle Municipal Code* Title 23, *Land Use Code*, and Title 15, *Street Use Code*,
11 and other City regulations, even when no permit is required. Signs having electrical wiring
12 and light fixtures are subject to the requirements of the *Seattle Electrical Code*.

13 **3107.3 Definitions**

14 **3107.3.1 Definitions – Building Code.** The following definitions are found in Chapter 2 of
15 this *Code*:

16 **AWNING SIGN.**

17 **CANOPY SIGN.**

18 **DISPLAY SURFACE.**

19 **NONSTRUCTURAL TRIM.**

20 **PROJECTING SIGN.**

21 **PROJECTION.**

22 **SIGN STRUCTURE.**

23 **VENEER.**

1 **3107.3.2 Definitions – Land Use Code.** The following sign-related definitions are found in
2 the Seattle *Land Use Code* Chapter 23.84A:

3 **ELECTRIC SIGN.**

4 **ON-PREMISES SIGN.**

5 **PROJECTING SIGN.**

6 **ROOF SIGN.**

7 **SIGN.**

8 **WALL SIGN.**

9 **3107.4 Permits.**

10 **3107.4.1 Permits required.** Except as otherwise specifically provided in this section, a
11 permit shall be obtained from the *building official* before any sign is erected, constructed,
12 posted, applied, or altered.

13 A permit must be obtained for:

- 14 1. All signs viewable from public rights of way, except signs considered temporary signs
15 by the *Land Use Code* Section 23.55.
- 16 2. All electric signs.
- 17 3. A new permit is required for existing signs when a different business entity uses the
18 sign.
- 19 4. Any display surface greater than 5 square feet (0.46 m²) in area.
- 20 5. Signs located within the interior of the building that are not visible from the public
21 right-of-way when:

1 5.1. The sign is mounted within the interior of a covered or open mall of a multi-
2 tenant retail facility and the sign is located over or adjoining the pedestrian
3 walking surface; or

4 5.2. When the sign is greater than 5 square feet (0.46 m²) in area; or

5 5.3 When it is an electric sign.

6 6. Existing signs that are removed and reinstalled.

7 7. Signs that are refurbished, retro-fitted, relocated or field-assembled.

8 **3107.4.2 Work exempt from permit.** A sign permit is not required for:

9 1. Changes made to the message copy installed on the display surface of a sign when the
10 sign structure is lawfully erected and is specifically designed for using manually
11 replaceable copy.

12 2. Maintenance which is limited to painting, repainting, cleaning and minor repairs.

13 3. Signs for public facilities that indicate danger or that provide service or safety
14 information and are not greater than 24 square feet (2.23 square meters).

15 **3107.4.3 Temporary signs.** The erection, re-erection, construction, posting or placement of
16 temporary signs that are allowed by Section 23.55.012 of the *Land Use Code* do not require a
17 sign permit. The owner of a temporary sign is responsible for compliance with the provisions
18 of this section and other applicable laws or codes regulating signs, and for the removal of any
19 temporary sign at the end of the allowed term. Failure to comply with the requirements of
20 either this *Code* or the *Land Use Code* is a violation and subject to the provisions of Section
21 103 of this *Code* and the provisions of Chapter 23.91 of the *Land Use Code*.

22 **3107.4.4 Maximum number of signs.** Temporary signs allowed by Section 23.55.012 of the
23 *Land Use Code* and signs not requiring a permit as specified in Section 3107.4.1 of this *Code*

1 are not counted as part of the maximum number of signs allowed under Chapter 23.55 of the
2 Land Use Code.

3 **3107.4.5 Attachments to signs.** Ancillary devices, displays and attachments, that are not part
4 of the original sign design for which a permit was issued, shall not be added to an existing
5 sign except as provided Chapter 23.55 of the Land Use Code and requires a new permit
6 issued by the building official.

7 Where ancillary devices, displays, electric signs or luminaires are attached to a sign
8 structure, the additional load of all attachments shall be included in the design loads and shall
9 comply with the requirements of Chapter 16 and Section 3107.10 of this Code.

10 **3107.5 Permit application.** To obtain a sign permit, the applicant shall submit an application to
11 the Department which provides the following information:

12 1. The address of the proposed sign installation;

13 2. Specifications, plans and drawings of the structure, site and vicinity, and a numbering
14 system that identifies the placement of each proposed sign on the elevation and plan
15 view drawings;

16 3. Signature, contact information and City business license number of the building owner;

17 4. Signature, contact information and City business license number of the business
18 establishment served by the sign or awning sign;

19 5. Signature, contact information, City business license number, and State contractor or
20 electrical contractor license number of the installer;

21 6. Electrical connection and illumination information when the sign has electrical
22 components; and

23 7. Permit fee as specified in the Fee Subtitle.

1 **Note:** Electrical permits are required for *electric signs* pursuant to the *Seattle Electrical Code*,
2 and street use permits shall be obtained from the Department of Transportation for signs over
3 any public place pursuant to the *Street Use Code*. Review and approval by the Department of
4 Neighborhoods is required for signs located on the site of a historic building, or in a landmark
5 or special review district.

6 **3107.6 Inspections.** All signs regulated by this chapter are subject to inspection by the *building*
7 *official*, including sign footings, refurbished or relocated used signs and retrofitted and field-
8 assembled signs. The permit holder must request a final inspection within 3 business days of
9 completing the installation. The *building official* may require an inspection of any temporary
10 sign to ensure public safety.

11 **3107.6.1 Electrical sign inspection.** All electrical wiring is subject to the *Seattle Electrical*
12 *Code*. Upon energizing an *electrical sign*, the permit holder must request an inspection
13 within one business day.

14 **3107.6.2 Sign footing inspection.** Footings for all signs greater than 5 square feet (0.46 m²)
15 in area require a footing inspection. An inspection must be requested and completed before
16 the footing is filled.

17 **3107.7 Maintenance and closure of business.**

18 **3107.7.1 Maintenance.** The owners of signs shall maintain their signs, together with all
19 supports, braces, guys and anchors, in good repair and in a proper state of preservation. The
20 owners shall keep display surfaces of all signs neatly painted or posted at all times. Failure to
21 maintain any sign, display surface or sign structure and the component parts is a violation
22 and subject to the provisions of Section 103 of this *Code*.

1 **3107.7.2 Closure of business and abandoned signs.** Upon the closure and vacation of a
2 business or activity, the operator of the business or activity is responsible for removing all
3 related signs within 90 days from the date of closure. If the operator fails to remove any sign
4 and the business or activity is not resumed during the 90-day period, then the owner of the
5 premises upon which the signs are located is responsible and must remove all signs within
6 180 days from the date of closure and vacation of the business or activity.

7 **Note:** A new permit is required for existing signs when a different business entity uses the sign.
8 See Section 3107.4.

9 **3107.8 Nonconforming signs.** Maintenance to keep a nonconforming sign in good condition is
10 required. Minor structural or electrical additions or alterations deemed to be necessary for public
11 safety may be authorized by the *building official*. A nonconforming sign, for the purpose of this
12 Code, is a sign or any portion of a sign which, because of its location or construction, could not
13 lawfully be reconstructed in its present location.

14 **3107.9 General requirements.**

15 **3107.9.1 General.** All signs shall conform to the requirements of this section.

16 **3107.9.2 Clearance from overhead electrical conductors.** Signs shall be located no closer
17 than 3 feet (914 mm) horizontally or 8 feet (2438 mm) vertically from overhead electrical
18 conductors which are energized at 1000 volts or less and not less than 10 feet (3048 mm) in
19 any direction from overhead conductors energized at more than 1000 volts.

20 **Exception:** Overhead conductors enclosed in an approved raceway or enclosure.

21 **3107.9.3 Clearance from fire escapes, exits or standpipes.** No sign or sign structure shall
22 be erected in such a manner that any portion of its surface or supports will interfere in any
23 way with the free use of any fire escape, exit or standpipe.

1 **3107.9.4 Obstruction of exits, light and ventilation.** No portion of the surface or support of
2 any sign shall be erected, constructed or maintained so as to obstruct any fire escape or
3 standpipe, or any window, door or opening used as a *means of egress*, or so as to prevent free
4 passage from one part of a roof to any other part of the roof. No sign, or portion of a sign,
5 shall be attached in any form, shape or manner to a fire escape or standpipe, nor be placed in
6 such a manner as to interfere with any opening providing the ventilation or light required by
7 Chapter 12 of this *Code*.

8 **3107.9.5 Supporting members.** Signs mounted on and attached to buildings shall be so
9 designed and mounted that secondary structural members shall be incorporated into and
10 become a part of the sign display. Exterior bracing such as angle irons, guy wires, cables and
11 similar devices are permitted only where no other reasonable method of fastening consistent
12 with safety is possible.

13 **3107.9.6 Non-display surfaces.** If a sign is visible from more than one direction, all areas
14 not intended as a display surface including the back and sides, shall be designed so the non-
15 display surfaces are given a finished appearance and the display surface is visible only from
16 the direction that it is intended to be seen.

17 **3107.9.7 Electrical permit sticker.** Each *electrical sign* shall display the electrical permit
18 sticker issued with the sign permit. The sticker shall be located where it is clearly visible
19 without use of a ladder and without requiring access into a building, unless otherwise
20 authorized by the *building official*.

21 **3107.9.8 Labels.** Every permanent sign shall display the name of the sign erector or
22 manufacturer. Electrical signs must display listing labels required by the *Seattle Electrical*
23 *Code*.

1 **3107.10 Design.**

2 **3107.10.1 General.** Signs and sign structures shall be designed and constructed to resist all
3 forces to which they are subject as specified in Chapter 16 and this section. All signs shall be
4 designed and installed to transfer all forces directly to the structural frame of the building or
5 structure. The overturning moment produced from lateral forces shall in no case exceed two-
6 thirds of the dead load resisting moment. Uplifts due to overturning shall be adequately
7 resisted by proper anchorage to the ground or to the structural frame of the building. The
8 weight of earth superimposed over footings is permitted to be used in determining the dead
9 load resisting moment. Such earth shall be carefully placed and thoroughly compacted.

10 **3107.10.2 Wind and seismic loads.** Signs and sign structures shall be designed and
11 constructed to resist wind and seismic forces as specified in Chapter 16 of this *Code*.

12 **3107.10.3 Allowable stresses.** The design of wood, concrete, steel or aluminum members
13 shall conform to the requirements of Chapters 19, 20, 22 and 23. Loads, both vertical and
14 horizontal, exerted on the soil shall not produce stresses exceeding those specified in Chapter
15 16 of this *Code*. The working stresses of wire rope and its fastenings shall not exceed 25
16 percent of the ultimate strength of the rope or fasteners.

17 **3107.11 Construction.**

18 **3107.11.1 General.** The supports for all signs and sign structures shall be placed in or upon
19 private property and shall be securely built, constructed, and erected in conformance with the
20 requirements of this chapter. All structural welding on signs and sign structures shall conform
21 to the requirements of Chapter 20 for aluminum and Chapter 22 for steel.

22 **3107.11.2 Materials.** Materials for construction of signs and sign structures shall be:

1 1. Of a quality and grade allowed by specific chapters in this Code for the materials
2 proposed; or

3 2. Listed or rated for the proposed use; or

4 3. Approved by the building official.

5 **3107.11.3 Approved materials.** The building official may require that sufficient technical
6 data be submitted to substantiate the proposed use of any material; and may approve use of
7 the material when the building official determines that the evidence submitted is satisfactory
8 for the intended use.

9 **3107.11.4 Anchorage.** Members supporting unbraced signs shall be so proportioned that the
10 bearing loads imposed on the soil in either direction, horizontal or vertical, shall not exceed
11 the design requirements.

12 Braced ground signs shall be anchored to resist the specified wind or seismic load acting
13 in any direction. Anchors and supports shall be designed for safe bearing loads on the soil
14 and for an effective resistance to pull-out amounting to a force 25 percent greater than the
15 required resistance to overturning.

16 Signs attached to masonry, concrete or steel shall be safely and securely fastened thereto
17 by means of metal anchors, bolts or approved expansion screws of sufficient size and
18 anchorage to support safely the loads applied. No wooden blocks or plugs or anchors with
19 wood used in connection with screws or nails is considered proper anchorage except in the
20 case of signs attached to wood framing.

21 No lead plugs or anchors shall be used to support signs. No anchor or support of any sign
22 shall be connected to or supported by an unbraced parapet wall unless the wall is designed or
23 braced for the added forces.

1 **3107.12 Roof signs.**

2 **3107.12.1 General.** Roof signs shall be constructed of approved material as specified in
3 Section 3107.11. The sign shall be secured and anchored to the structural frame of the
4 building.

5 **3107.12.2 Clear passage.** A passage clear of all obstructions shall be left under or around,
6 and immediately adjacent to, signs exceeding a height of 4 feet (1219 mm) above the roof.
7 The passage shall not be less than 3 feet (914 mm) wide and 4 feet (1219 mm) high and shall
8 be at parapet or roof level. There shall be one clear passage opening as follows:

9 1. One for each roof sign.

10 2. One for every 50 lineal feet (15 240 mm) of horizontally running sign structure.

11 3. Within 20 feet (6096 mm) of walls and parapets when roof signs are at right angles to a
12 face of the building.

13 **3107.13 Electrical signs.**

14 **3107.13.1 Construction.** Structures supporting *electrical signs* shall comply with Section
15 3107.11 of this Code.

16 **3107.13.2 Installation.** Electrical signs and branch circuits supplying power to electric signs
17 shall be installed in accordance with the Article 600 of the *Seattle Electrical Code.*

18 **3107.13.3 Inspections.** The permit holder must request a final inspection within 3 business
19 days of completing the installation or within one business day upon energizing an *electrical*
20 *sign.*

21 ***

22 **SECTION 3109**

23 **SWIMMING POOLS, SPAS AND HOT TUBS**

1 **[W] 3109.1 General.** The design and construction of swimming pools, spas and ((hot tubs)) other
2 aquatic recreation facilities shall comply with the *International Swimming Pool and Spa Code*,
3 where the facility is one of the following:

- 4 1. For the sole use of residents and invited guests at a single-family dwelling;
- 5 2. For the sole use of residents and invited guests of a duplex owned by the residents;
- 6 3. Operated exclusively for physical therapy or rehabilitation and under the supervision of
7 licensed medical practitioner.

8 All other “water recreation facilities” as defined in RCW 70.90.110 are regulated under
9 chapters 246-260 and 246-262 WAC.

10 ***

11 Section 27. The following sections of Chapter 32 of the International Building Code,
12 2015 Edition, are amended as follows:

13 **CHAPTER 32**

14 **ENCROACHMENTS INTO THE PUBLIC RIGHT-OF-WAY**

15 **SECTION 3201**

16 **GENERAL**

17 ***

18 ~~((3201.4 Drainage. Drainage water collected from a roof, awning, canopy or marquee, and~~
19 ~~condensate from mechanical equipment shall not flow over a public walking surface.))~~

20 **3201.4 Approval of encroachments.** All encroachments of buildings and structures on, over or
21 under sidewalks, streets and other public places are subject to approval by the Director of
22 Transportation and the building official. Encroachments shall comply with this code and other
23 applicable codes including Seattle Municipal Code, Title 15.

1 **3201.5 Doors and gates.** No door or gate in any position shall project over public property.

2 **3201.6 Materials.** Structures and appendages regulated by this code shall be constructed of
3 materials specified in this code for structures on private property.

4 ((SECTION 3202

5 ENCROACHMENTS))

6 ((~~3202.1 Encroachments below grade.~~ Encroachments below grade shall comply with Sections
7 ~~3202.1.1 through 3202.1.3.~~

8 ~~**3202.1.1 Structural support.** A part of a building erected below grade that is necessary for~~
9 ~~structural support of the building or structure shall not project beyond the lot lines, except~~
10 ~~that the footings of street walls or their supports that are located not less than 8 feet (2438~~
11 ~~mm) below grade shall not project more than 12 inches (305 mm) beyond the street lot line.~~

12 ~~**3202.1.2 Vaults and other enclosed spaces.** The construction and utilization of vaults and~~
13 ~~other enclosed spaces below grade shall be subject to the terms and conditions of the~~
14 ~~applicable governing authority.~~

15 ~~**3202.1.3 Areaways.** Areaways shall be protected by grates, guards or other approved means.~~

16 ~~**3202.2 Encroachments above grade and below 8 feet in height.** Encroachments into the public~~
17 ~~right-of-way above grade and below 8 feet (2438 mm) in height shall be prohibited except as~~
18 ~~provided for in Sections 3202.2.1 through 3202.2.3. Doors and windows shall not open or~~
19 ~~project into the public right-of-way.~~

20 ~~**3202.2.1 Steps.** Steps shall not project more than 12 inches (305 mm) and shall be guarded~~
21 ~~by approved devices not less than 3 feet (914 mm) in height, or shall be located between~~
22 ~~columns or pilasters.~~

1 ~~**3202.2.2 Architectural features.** Columns or pilasters, including bases and moldings, shall~~
2 ~~not project more than 12 inches (305 mm). Belt courses, lintels, sills, architraves, pediments~~
3 ~~and similar architectural features shall not project more than 4 inches (102 mm).~~

4 ~~**3202.2.3 Awnings.** The vertical clearance from the public right-of-way to the lowest part of~~
5 ~~any awning, including valances, shall be not less than 7 feet (2134 mm).~~

6 ~~**3202.3 Encroachments 8 feet or more above grade.** Encroachments 8 feet (2438 mm) or more~~
7 ~~above grade shall comply with Sections 3202.3.1 through 3202.3.4.~~

8 ~~**3202.3.1 Awnings, canopies, marquees and signs.** Awnings, canopies, marquees and signs~~
9 ~~shall be constructed so as to support applicable loads as specified in Chapter 16. Awnings,~~
10 ~~canopies, marquees and signs with less than 15 feet (4572 mm) clearance above the sidewalk~~
11 ~~shall not extend into or occupy more than two-thirds the width of the sidewalk measured~~
12 ~~from the building. Stanchions or columns that support awnings, canopies, marquees and~~
13 ~~signs shall be located not less than 2 feet (610 mm) in from the curb line.~~

14 ~~**3202.3.2 Windows, balconies, architectural features and mechanical equipment.** Where~~
15 ~~the vertical clearance above grade to projecting windows, balconies, architectural features or~~
16 ~~mechanical equipment is more than 8 feet (2438 mm), 1 inch (25 mm) of encroachment is~~
17 ~~permitted for each additional 1 inch (25 mm) of clearance above 8 feet (2438 mm), but the~~
18 ~~maximum encroachment shall be 4 feet (1219 mm).~~

19 ~~**3202.3.3 Encroachments 15 feet or more above grade.** Encroachments 15 feet (4572 mm)~~
20 ~~or more above grade shall not be limited.~~

21 ~~**3202.3.4 Pedestrian walkways.** The installation of a pedestrian walkway over a public right-~~
22 ~~of-way shall be subject to the approval of the applicable governing authority. The vertical~~

1 ~~clearance from the public right of way to the lowest part of a pedestrian walkway shall be~~
2 ~~not less than 15 feet (4572 mm).~~

3 ~~**3202.4 Temporary encroachments.** Where allowed by the applicable governing authority,~~
4 ~~vestibules and storm enclosures shall not be erected for a period of time exceeding seven months~~
5 ~~in any one year and shall not encroach more than 3 feet (914 mm) nor more than one-fourth of~~
6 ~~the width of the sidewalk beyond the street lot line. Temporary entrance awnings shall be erected~~
7 ~~with a clearance of not less than 7 feet (2134 mm) to the lowest portion of the hood or awning~~
8 ~~where supported on removable steel or other approved non-combustible support.))~~

9 Section 28. The following sections of Chapter 33 of the International Building Code,
10 2015 Edition, are amended as follows:

11 **CHAPTER 33**

12 **SAFEGUARDS DURING CONSTRUCTION**

13 ***

14 **SECTION 3303**

15 **DEMOLITION**

16 ***

17 **3303.2 Pedestrian protection.** The work of demolishing any building shall not be commenced
18 until pedestrian protection is in place as required by this chapter and the Street Use Ordinance,
19 Seattle Municipal Code Title 15.

20 ***

21 ~~((**3303.4 Vacant lot.** Where a structure has been demolished or removed, the vacant lot shall be~~
22 ~~filled and maintained to the existing grade or in accordance with the ordinances of the jurisdiction~~
23 ~~having authority.))~~

1 **3303.4 Surface condition and fill.** The site shall be left level and free of debris upon completion
2 of demolition, and all holes shall be filled or protected with secure fences. Holes are permitted to
3 be filled with concrete, rocks or other nondecaying material no larger than 12 inches (305 mm)
4 in diameter. Wood and other organic material shall not be buried on the site.

5 Leaving the site level means:

6 1. The grade conforms to that existing on all sides;

7 2. Surface water will drain off;

8 3. Surface is smooth; and

9 4. Broken sections of the foundation or other material are not exposed.

10 The site shall be seeded upon completion of the demolition if it is to be left vacant for more
11 than 6 months.

12 **3303.5 Water accumulation.** Provision shall be made to prevent the accumulation of water or
13 damage to any foundations on the premises or the adjoining property.

14 **3303.6 Utility connections.** Service utility connections shall be discontinued and capped in
15 accordance with ~~((the approved rules and the requirements of the applicable governing~~
16 ~~authority.)) requirements of the governing utility or agency including, but not limited to, Seattle~~
17 Public Utilities, Seattle Department of Transportation, Seattle Fire Department, Seattle City
18 Light, Puget Sound Energy and Century Link.

19 **3303.7 Fire safety during demolition.** Fire safety during demolition shall comply with the
20 applicable requirements of this code and the applicable provisions of Chapter 33 of the
21 *International Fire Code.*

22 **3303.8 Removal of hazardous and combustibile materials.** All asbestos and other hazardous
23 material shall be removed prior to demolition, in accordance with regulations of the

1 Environmental Protection Agency, the Puget Sound Clean Air Agency and other pertinent
2 agencies. Combustible waste shall be removed in accordance with the *International Fire Code*.

3 During demolition, streets and sidewalks shall be left clean at the end of each day's operation.

4 **3303.9 Welding and cutting.** Welding and cutting shall be performed in accordance with the
5 *International Fire Code*.

6 **3303.10 Erosion and sediment control.** Provision shall be made to stabilize ground conditions
7 to eliminate dust and erosion. Demolition sites shall comply with *Seattle Municipal Code* Title
8 22 Subtitle VIII, the *Seattle Stormwater Code* and *Seattle Municipal Code* Chapter 22.170, the
9 *Seattle Grading Code*.

10 **3303.11 Drainage.** If the demolition will result in a change of drainage patterns, the flow of all
11 watercourses, including streams, ditches, drains, combined sewers and runoff, intercepted
12 during the progress of the work, shall be returned to the condition present before the demolition
13 or as specified on the permit, and in accordance with *Seattle Municipal Code* Title 22 Subtitle
14 VIII, the *Seattle Stormwater Code* and *Seattle Municipal Code* Chapter 22.170, the *Seattle*
15 *Grading Code*, respectively.

16 **3303.12 Foundations and footings.** All concrete or masonry floors, foundations, footings,
17 basement walls and retaining walls not to be reused shall be removed to 18 inches (457 mm)
18 below final grade. All concrete floors left in place shall be broken so as to allow water to drain
19 through unless the floors are to be used.

20 **3303.13 Engineer's report.** The *building official* is permitted to require a structural engineer's
21 analysis of proposed demolition or any portions of a structure remaining after demolition.

22 **3303.14 Underground tanks.** When demolition occurs, all underground tanks on the site shall
23 either be removed or filled, as required by the *International Fire Code*.

1 **3303.15 Rat eradication program.** All applicants for a demolition permit shall initiate a rat
2 eradication program on the project site at least 15 days prior to the start of demolition or any
3 clearing or grading activity on the demolition site.

4 **3303.15.1 Duration of rat eradication program.** The rat eradication program must continue
5 at least until demolition begins. No demolition or clearing or grading on the demolition site
6 shall begin until the rat eradication program is complete unless approved by the building
7 official. The rat eradication program may be terminated or waived by the building official
8 when supported by a written recommendation of a licensed pest control agent.

9 **3303.15.2 Requirements of rat eradication program.** The rat eradication program shall be
10 approved by a qualified pest control agent and shall comply with the Seattle-King County
11 Public Health Department guidelines and recommendations for rat baiting. The use of any
12 pesticide shall comply with WAC 16-228-1380. The building official may require additional
13 deterrent measures on recommendation of the Seattle-King County Public Health
14 Department.

15 **3303.15.3 Demolition permit.** The building official shall not issue any demolition permit
16 until the applicant has provided a copy of the rat eradication program and a declaration that
17 the requirements of Section 3303.15 have been or will be complied with prior to the start of
18 demolition.

19 **SECTION 3304**

20 **SITE WORK**

21 ***

22 ~~((3304.1.3 Footings on adjacent slopes. For footings on adjacent slopes, see Chapter 18.))~~

23 ***

1 ~~**3306.5 Barriers.** Barriers shall be not less than 8 feet (2438 mm) in height and shall be placed~~
2 ~~on the side of the walkway nearest the construction. Barriers shall extend the entire length of the~~
3 ~~construction site. Openings in such barriers shall be protected by doors that are normally kept~~
4 ~~closed.~~

5 ~~**3306.6 Barrier design.** Barriers shall be designed to resist loads required in Chapter 16 unless~~
6 ~~constructed as follows:~~

7 ~~1. Barriers shall be provided with 2-inch by 4-inch (51 mm by 102 mm) top and bottom~~
8 ~~plates.~~

9 ~~2. The barrier material shall be boards not less than 3/4 inch (19.1 mm) thick or wood~~
10 ~~structural panels not less than 1/4-inch (6.4 mm) thick.~~

11 ~~3. Wood structural use panels shall be bonded with an adhesive identical to that for exterior~~
12 ~~wood structural use panels.~~

13 ~~4. Wood structural use panels 1/4 inch (6.4 mm) or 5/16 inch (23.8 mm) in thickness shall have~~
14 ~~studs spaced not more than 2 feet (610 mm) on center.~~

15 ~~5. Wood structural use panels 3/8 inch (9.5 mm) or 1/2 inch (127 mm) in thickness shall have~~
16 ~~studs spaced not more than 4 feet (1219 mm) on center provided a 2-inch by 4-inch (51~~
17 ~~mm by 102 mm) stiffener is placed horizontally at mid-height where the stud spacing is~~
18 ~~greater than 2 feet (610 mm) on center.~~

19 ~~6. Wood structural use panels 5/8 inch (15.9 mm) or thicker shall not span over 8 feet (2438~~
20 ~~mm).~~

| |
|---------------------|
| TABLE 3306.1 |
|---------------------|

| |
|----------------------------------|
| PROTECTION OF PEDESTRIANS |
|----------------------------------|

| HEIGHT OF CONSTRUCTION | DISTANCE FROM CONSTRUCTION TO LOT LINE | TYPE OF PROTECTION REQUIRED |
|------------------------|--|-----------------------------|
| 8 feet or less | Less than 5 feet | Construction railings |
| | 5 feet or more | None |
| More than 8 feet | Less than 5 feet | Barrier and covered walkway |
| | 5 feet or more, but not more than one-fourth the height of construction | Barrier and covered walkway |
| | 5 feet or more, but between one-fourth and one-half the height of construction | Barrier |
| | 5 feet or more, but exceeding one-half the height of construction | None |

1 **3306.7 Covered walkways.** Covered walkways shall have a clear height of not less than 8 feet
 2 (2438 mm) as measured from the floor surface to the canopy overhead. Adequate lighting shall
 3 be provided at all times. Covered walkways shall be designed to support all imposed loads. In no
 4 case shall the design live load be less than 150 psf (7.2 kN/m²) for the entire structure.

5 **Exception:** Roofs and supporting structures of covered walkways for new, light frame
 6 construction not exceeding two *stories above grade plane* are permitted to be designed for a
 7 live load of 75 psf (3.6 kN/m²) or the loads imposed on them, whichever is greater. In lieu of
 8 such designs, the roof and supporting structure of a covered walkway are permitted to be
 9 constructed as follows:

- 10 1. Footings shall be continuous 2-inch by 6-inch (51 mm by 152 mm) members.

1 ~~2. Posts not less than 4 inches by 6 inches (102 mm by 152 mm) shall be provided on~~
2 ~~both sides of the roof and spaced not more than 12 feet (3658 mm) on center.~~

3 ~~3. Stringers not less than 4 inches by 12 inches (102 mm by 305 mm) shall be placed on~~
4 ~~edge upon the posts.~~

5 ~~4. Joists resting on the stringers shall be not less than 2 inches by 8 inches (51 mm by~~
6 ~~203 mm) and shall be spaced not more than 2 feet (610 mm) on center.~~

7 ~~5. The deck shall be planks not less than 2 inches (51 mm) thick or wood structural~~
8 ~~panels with an exterior exposure durability classification not less than 23/32 inch~~
9 ~~(18.3 mm) thick nailed to the joists.~~

10 ~~6. Each post shall be knee braced to joists and stringers by members not less than 2~~
11 ~~inches by 4 inches (51 mm by 102 mm); 4 feet (1219 mm) in length.~~

12 ~~7. A curb that is not less than 2 inches by 4 inches (51 mm by 102 mm) shall be set on~~
13 ~~edge along the outside edge of the deck.~~

14 **3306.8 Repair, maintenance and removal.** Pedestrian protection required by this chapter shall
15 be maintained in place and kept in good order for the entire length of time pedestrians are subject
16 to being endangered. The *owner* or the *owner's* authorized agent, upon the completion of the
17 construction activity, shall immediately remove walkways, debris and other obstructions and
18 leave such public property in as good a condition as it was before such work was commenced.

19 **3306.9 Adjacent to excavations.** Every excavation on a site located 5 feet (1524 mm) or less
20 from the street *lot line* shall be enclosed with a barrier not less than 6 feet (1829 mm) in height.
21 Where located more than 5 feet (1524 mm) from the street *lot line*, a barrier shall be erected
22 where required by the *building official*. Barriers shall be of adequate strength to resist wind
23 pressure as specified in Chapter 16.))

SECTION 3307

PROTECTION OF ADJOINING PROPERTY

1
2
3 **3307.1 Protection required.** Adjoining public and private property shall be protected from
4 damage during construction, remodeling and demolition work. Protection shall be provided for
5 footings, foundations, party walls, chimneys, skylights and roofs. Provisions shall be made to
6 control water runoff and erosion during construction or demolition activities. ~~((The person
7 making or causing an excavation to be made shall provide written notice to the owners of
8 adjoining buildings advising them that the excavation is to be made and that the adjoining
9 buildings should be protected. Said notification shall be delivered not less than 10 days prior to
10 the scheduled starting date of the excavation.))~~ When the existing grade of a site is altered by
11 filling, excavating, dredging or moving of earth materials, the owner shall protect all adjoining
12 property during construction from encroachment or collapse by sloping the sides of the
13 temporary grading at a slope that is safe and not more than one horizontal to one vertical. In
14 addition, adjoining property shall be protected from encroachment or collapse by sloping the
15 sides of the permanent grading at a slope not greater than two horizontal to one vertical. The
16 building official is authorized to approve temporary or permanent slopes that are steeper based
17 on a design by an experienced geotechnical engineer.

18 In areas of known unsuitable soils, the building official is authorized to require slopes that are
19 less steep to assure protection of adjoining property.

SECTION 3308

TEMPORARY USE OF STREETS, ALLEYS AND PUBLIC PROPERTY

21
22 **3308.1 General.** Temporary use of streets, alleys and public property shall comply with the
23 Street Use Ordinance, Seattle Municipal Code Title 15. ~~((Storage and handling of materials.~~

1 ~~The temporary use of streets or public property for the storage or handling of materials or of~~
2 ~~equipment required for construction or demolition, and the protection provided to the public shall~~
3 ~~comply with the provisions of the applicable governing authority and this chapter.~~

4 **3308.1.1 Obstructions.** ~~Construction materials and equipment shall not be placed or~~
5 ~~stored so as to obstruct access to fire hydrants, standpipes, fire or police alarm boxes,~~
6 ~~catch basins or manholes, nor shall such material or equipment be located within 20 feet~~
7 ~~(6096 mm) of a street intersection, or placed so as to obstruct normal observations of~~
8 ~~traffic signals or to hinder the use of public transit loading platforms.~~

9 **3308.2 Utility fixtures.** ~~Building materials, fences, sheds or any obstruction of any kind shall~~
10 ~~not be placed so as to obstruct free approach to any fire hydrant, fire department connection,~~
11 ~~utility pole, manhole, fire alarm box or catch basin, or so as to interfere with the passage of~~
12 ~~water in the gutter. Protection against damage shall be provided to such utility fixtures during~~
13 ~~the progress of the work, but sight of them shall not be obstructed.))~~

14 ***

15 SECTION 3310

16 MEANS OF EGRESS

17 ***

18 **3310.3 Stairway floor number signs.** ~~Temporary stairway floor number signs shall be~~
19 ~~provided in accordance with the requirements of Section 1023.9.~~

20 ***

21 SECTION 3312

22 AUTOMATIC SPRINKLER SYSTEM

1 **[F] 3312.1 Completion before occupancy.** In buildings where an *automatic sprinkler system* is
2 required by this code, it shall be unlawful to occupy any portion of a building or structure until
3 the *automatic sprinkler system* installation has been tested and *approved*, (~~except as provided~~
4 ~~in Section 111.3~~) unless approved by the building official.

5 ***

6 **SECTION 3314**

7 **CONSTRUCTION MATERIAL MANAGEMENT**

8 **3314.1 Storage and handling of materials.** Materials stored and handled on site during
9 construction shall comply with the manufacturer's printed instructions. Where manufacturer's
10 printed instructions are not available, approved standards or guidelines shall be followed.

11 **3314.2 Construction phase moisture control.** Porous or fibrous materials and other materials
12 subject to moisture damage shall be protected from moisture during construction. Material
13 damaged by moisture or that is visibly colonized by fungi either prior to delivery or during
14 construction shall be cleaned and dried or, where damage cannot be corrected by such means,
15 shall be removed and replaced.

16 Section 29. Sections 2 through 27 of Ordinance 124273 are repealed.

17 Section 30. Beginning on the effective date of this ordinance and ending on January 1,
18 2017, permit applicants who submit a valid and fully complete building permit application
19 during that period may elect to have the application reviewed under the provisions of Ordinance
20 124273 rather than this ordinance.

21 Section 31. The provisions of this ordinance are declared to be separate and severable.
22 The invalidity of any clause, sentence, paragraph, subdivision, section or portion of this
23 ordinance, or the invalidity of the application thereof to any person, owner, or circumstance shall

- 1 not affect the validity of the remainder of this ordinance, or the validity of its application to other
- 2 persons, owners, or circumstances.

1 Section 32. This ordinance shall take effect and be in force 30 days after its approval by
2 the Mayor, but if not approved and returned by the Mayor within ten days after presentation, it
3 shall take effect as provided by Seattle Municipal Code Section 1.04.020.

4 Passed by the City Council the 3rd day of October, 2016,
5 and signed by me in open session in authentication of its passage this 3rd day of
6 October, 2016.

7 

8 President _____ of the City Council

9 Approved by me this 7th day of October, 2016.

10 

11 Edward B. Murray, Mayor

12 Filed by me this 7th day of OCTOBER, 2016.

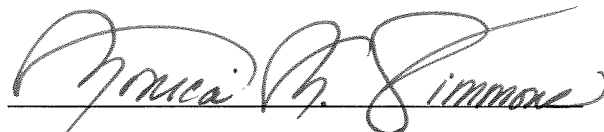
13 

14 Monica Martinez Simmons, City Clerk

15 (Seal)