



SEATTLE CITY COUNCIL

Legislative Summary

CB 118683

Record No.: CB 118683

Type: Ordinance (Ord)

Status: Passed

Version: 2

Ord. no: Ord 125173

In Control: City Clerk

File Created: 04/26/2016

Final Action: 10/28/2016

Title: AN ORDINANCE amending the Seattle Comprehensive Plan to incorporate changes responding to Resolution 31577 to increase the Plan's emphasis on race and social equity and improve its readability; modifying or adding new goals and policies in several elements of the Plan that describe the City's objectives for distributing housing and employment growth; and amending Sections 5.72.020, 23.34.008, 23.45.516, 23.47A.012, 23.47A.013, 23.49.056, 23.49.058, 23.51A.004, 23.58A.040, 23.69.030, 23.75.002, and 23.84A.040 of the Seattle Municipal Code to revise references to the updated Comprehensive Plan.

Date

Notes:

Filed with City Clerk:

Mayor's Signature:

Sponsors: Johnson

Vetoed by Mayor:

Veto Overridden:

Veto Sustained:

Attachments: Full Text: CB 118683 v2, Att 1 - Seattle 2035 Comprehensive Plan, Att 2 - City Council Amendments 2-17 to Seattle 2035 Comprehensive Plan v2, Att 2 - City Council Amendments 2-17 to Seattle 2035 Comprehensive Plan v1

Drafter: valauri.stotler@seattle.gov

Filing Requirements/Dept Action:

History of Legislative File

Legal Notice Published:

Yes

No

Version:	Acting Body:	Date:	Action:	Sent To:	Due Date:	Return Date:	Result:
1	Mayor	05/03/2016	Mayor's leg transmitted to Council	City Clerk			
	Action Text:		The Council Bill (CB) was Mayor's leg transmitted to Council. to the City Clerk				
	Notes:						
1	City Clerk	05/03/2016	sent for review	Council President's Office			
	Action Text:		The Council Bill (CB) was sent for review. to the Council President's Office				
	Notes:						

- 1 Council President's Office 05/09/2016 sent for review Planning, Land Use, and Zoning Committee
Action Text: The Council Bill (CB) was sent for review. to the Planning, Land Use, and Zoning Committee
Notes:
- 1 Full Council 05/16/2016 referred Planning, Land Use, and Zoning Committee
Action Text: The Council Bill (CB) was referred. to the Planning, Land Use, and Zoning Committee
Notes:
- 1 Planning, Land Use, and Zoning Committee 05/17/2016 discussed
Action Text: The Council Bill (CB) was discussed in Committee.
- 1 Planning, Land Use, and Zoning Committee 06/07/2016 discussed
Action Text: The Council Bill (CB) was discussed.
Notes:
- 1 Planning, Land Use, and Zoning Committee 06/21/2016
Action Text:
Notes: The Committee did not discuss this item.
- 1 Planning, Land Use, and Zoning Committee 06/27/2016 discussed
Action Text: The Council Bill (CB) was discussed.
Notes: The Committee held a Public Hearing relating to Council Bill 118692.
- 1 Planning, Land Use, and Zoning Committee 07/08/2016 discussed
Action Text: The Council Bill (CB) was discussed in Committee.
Notes:
- 1 Planning, Land Use, and Zoning Committee 08/16/2016 discussed
Action Text: The Council Bill (CB) was discussed.
- 1 Planning, Land Use, and Zoning Committee 09/09/2016 discussed
Action Text: The Council Bill (CB) was discussed.
Notes:
- 1 Planning, Land Use, and Zoning Committee 09/15/2016 discussed
Action Text: The Council Bill (CB) was discussed.
Notes: The Committee held a public hearing on Council Bill 118683.
- 1 Planning, Land Use, and Zoning Committee 09/20/2016 pass as amended Pass
Action Text: The Committee recommends that Full Council pass as amended the Council Bill (CB).
In Favor: 3 Chair Johnson, Vice Chair O'Brien, Member Herbold
Opposed: 0
- 2 Full Council 10/17/2016 passed as amended Pass
Action Text: The Motion carried, the Council Bill (CB) was passed as amended by the following vote, and the President signed the Bill:
Notes: ACTION 1:

Motion was made by Councilmember Herbold, duly seconded and carried, to amend Council Bill 118683, with Amendments 1 through 5, as shown in the

strike through and underlined language below:

Amendment 1

Attachment 15, Definitions, adding a new "community plan" definition.

Define the term "community plan" as "a plan developed in collaboration with a community around a shared vision that includes a set of strategies to meet community and city goals."

Amendment 2

Attachment 3, amending the Discussion under "Inclusive and Equitable Community Involvement."

Equity is essential to any community involvement process to improve relationships and outcomes. The City is committed to conducting inclusive and equitable community involvement that effectively reaches a broad range of community members, particularly those directly affected by the City's decisions. Community involvement should reflect Seattle's commitment to race and social justice, and use practices that are culturally sensitive, responsive and address barriers to participation of marginalized communities.

Amendment 3

Attachment 3, amending Community and Neighborhood Planning Goal CI G2.

CI G2 Work with a broad range of community members to plan for ~~the future of their community to provide homes, jobs, recreation, transportation options and gathering places~~ in their community.

Amendment 4

Attachment 3, amending Policy CI 2.3.

CI 2.3 Consider areas with the following characteristics when allocating City resources for community planning.

- Areas designated urban centers or villages in the Comprehensive Plan
- Areas with high risk of displacement

- Areas with low access to opportunity and distressed communities
- Areas experiencing significant improvements in transit service
- Areas experiencing a growth rate significantly higher or lower than anticipated in the Comprehensive Plan
- Areas identified for multiple capital investments that could benefit from coordinated planning
- Areas experiencing environmental justice concerns
- Areas with outdated community or neighborhood plans that no longer reflect current conditions, a citywide vision of the Comprehensive Plan, or local priorities

Amendment 5

Attachment 3, adding a new Policy CI 2.12.

CI 2.12 Provide sufficient funding and resources to work with communities to update community and neighborhood plans to maintain their relevancy and consistency with community goals and the citywide policies of the Comprehensive Plan.

ACTION 2:

Motion was made by Councilmember Harrell, duly seconded and carried, to amend Council Bill 118683, Attachment 3, Policy C1.2.3, as shown in the underlined language below:

CI 2.3 Consider areas with the following characteristics when allocating City resources for community planning.

- Areas designated urban centers or villages in the Comprehensive Plan
- Areas with high risk of displacement
- Areas with low access to opportunity and distressed communities
- Areas experiencing significant improvements in transit service
- Areas experiencing a growth rate significantly higher or lower than anticipated in the Comprehensive Plan
- Areas identified for multiple capital investments that could benefit from coordinated planning
- Areas experiencing environmental justice concerns including public health or safety concerns
- Areas with outdated community or neighborhood plans that no longer reflect current conditions, a citywide vision of the Comprehensive Plan, or local priorities

ACTION 3:

By unanimous consent, Public Comment was extended to allow additional Public Comment on Council Bill 118683.

Cindy Barker addressed the Council regarding Agenda item 5, Council Bill 118683.

Donn Cave addressed the Council regarding Agenda item 5, Council Bill 118683.

Collen McAleer addressed the Council regarding Agenda item 5, Council Bill 118683.

Chris Leman addressed the Council regarding Agenda item 5, Council Bill 118683.

David Ward addressed the Council regarding Agenda item 5, Council Bill 118683.

Richard Ellison addressed the Council regarding Agenda item 5, Council Bill 118683.

Public Comment on Council Bill 118683 was closed.

ACTION 4:

Motion was made and duly seconded to pass Council Bill 118683 as amended.

In Favor: 9 Councilmember Bagshaw, Councilmember Burgess, Councilmember González , Council President Harrell, Councilmember Herbold, Councilmember Johnson, Councilmember Juarez, Councilmember O'Brien, Councilmember Sawant

Opposed: 0

- 2 City Clerk 10/19/2016 submitted for Mayor
Mayor's signature
Action Text: The Council Bill (CB) was submitted for Mayor's signature. to the Mayor
Notes:
- 2 Mayor 10/28/2016 returned City Clerk
- 2 Mayor 10/28/2016 Signed
Action Text: The Council Bill (CB) was Signed.
Notes:
- 2 City Clerk 10/28/2016 attested by City Clerk
Action Text: The Ordinance (Ord) was attested by City Clerk.

Notes:

CITY OF SEATTLE

ORDINANCE 125173

COUNCIL BILL 118683

AN ORDINANCE amending the Seattle Comprehensive Plan to incorporate changes responding to Resolution 31577 to increase the Plan’s emphasis on race and social equity and improve its readability; modifying or adding new goals and policies in several elements of the Plan that describe the City’s objectives for distributing housing and employment growth; and amending Sections 5.72.020, 23.34.008, 23.45.516, 23.47A.012, 23.47A.013, 23.49.056, 23.49.058, 23.51A.004, 23.58A.040, 23.69.030, 23.75.002, and 23.84A.040 of the Seattle Municipal Code to revise references to the updated Comprehensive Plan.

WHEREAS, the City of Seattle adopted its Comprehensive Plan with Ordinance 117221 in 1994, pursuant to the provisions of the State Growth Management Act, RCW 36.70A; and

WHEREAS, the City has made amendments to its Comprehensive Plan annually, as authorized by the State Growth Management Act; and

WHEREAS, the Department of Planning and Development, now known as the Office of Planning and Community Development, in cooperation with other City agencies including the Seattle Planning Commission, began in 2013 a series of programs and events, under the title Seattle 2035, to engage the public in discussions about potential changes to the Comprehensive Plan, consistent with the Seattle 2035 Public Participation Plan and documented in the Seattle 2035 Public Engagement Report; and

WHEREAS, in May 2015 the Department of Planning and Development published a Draft Environmental Impact Statement analyzing the potential effects of four different growth distributions in the city through 2035, conducted a public hearing, and received comments from the public on this document; and

1 WHEREAS, in May 2015, the Department of Planning and Development published a Growth
2 and Equity report that analyzed the effects of four growth distributions on the city's
3 marginalized populations; and

4 WHEREAS, in July 2015 the Department of Planning and Development published a Draft
5 Comprehensive Plan and provided four months for the public to review and comment;
6 and

7 WHEREAS, in April 2016 the Puget Sound Regional Council certified that the City's
8 Comprehensive Plan, as amended in 2015, is consistent with multicounty planning
9 policies and the regional transportation plan and conforms to Growth Management Act
10 requirements for transportation planning; and

11 WHEREAS, the Director's Report accompanying this ordinance shows the recommended
12 changes to goals and policies between the current Comprehensive Plan and the updated
13 Plan; and

14 WHEREAS, in April 2016 the Office of Planning and Community Development published a
15 Final Environmental Impact Statement that included analysis of five growth scenarios,
16 including a preferred alternative; and

17 WHEREAS, the Council has considered public testimony made at public hearings and other
18 pertinent materials regarding the proposed amendments; and

19 WHEREAS, the Council finds that the amendments to be adopted are consistent with the Growth
20 Management Act, and will promote the health, safety and welfare of the general public;

21 NOW, THEREFORE,

22 **BE IT ORDAINED BY THE CITY OF SEATTLE AS FOLLOWS:**

1 Section 1. The Seattle Comprehensive Plan, last amended by Ordinance 124888, is
2 hereby repealed and replaced by Attachment 1 to this ordinance, as amended by the Council
3 Amendments listed in Attachments 2 through 17 to this ordinance. The Office of Planning and
4 Community Development (OPCD) is directed to compile and publish a final version of the
5 Seattle Comprehensive Plan that incorporates the amendments shown in Attachments 2 through
6 17. The Council requests that OPCD include hyperlinks to other documents referenced in the
7 plan, as the Office deems appropriate, in any version of the plan that is published online.

8 Section 2. Subsection 23.34.008.A of the Seattle Municipal Code, which section was last
9 amended by Ordinance 123770, is amended as follows:

10 **23.34.008 General rezone criteria.**

11 A. To be approved a rezone shall meet the following standards:

12 1. In urban centers and urban villages the zoned capacity for the center or village
13 taken as a whole shall be no less than ~~((one hundred twenty five percent ()))~~ 125~~((%))~~ percent of
14 the growth ~~((targets))~~ estimates adopted in the Comprehensive Plan for that center or village.

15 2. For the area within the urban village boundary of hub urban villages and for
16 residential urban villages taken as a whole the zoned capacity shall not be less than the densities
17 established in the Urban Village Element of the Comprehensive Plan.

18 * * *

19 Section 3. Subsection 23.45.516.D of the Seattle Municipal Code, which section was last
20 amended by Ordinance 124952, is amended as follows:

21 **23.45.516 Additional height and extra residential floor area in MR and HR zones**

22 * * *

23 D. Transferable Development Potential (TDP) from Landmark structures and open space

1 1. Sending lots. TDP may be transferred under the provisions of Section
2 23.58A.040, as modified by this Section 23.45.516, only from Landmark TDP sites and open
3 space TDP sites. In order to be eligible as a Landmark TDP site or open space TDP site, a lot
4 shall be located in ~~((the)) First Hill ((Urban Center Village))~~ and shall be zoned MR or HR.
5 Sending lots are subject to the limits and conditions in this Chapter 23.45 and Chapter 23.58A.
6 The amount of TDP that may be transferred from a lot is limited to the amount by which the base
7 FAR under Section 23.45.510 exceeds floor area on the lot that is not exempt under Section
8 23.45.510.

9 2. Receiving lots. Any lot located in an HR zone within ~~((the)) First Hill ((Urban
10 Center Village))~~ is eligible for extra residential floor area according to the provisions of this
11 Section 23.45.516 to receive TDP from an eligible sending lot, subject to the limits and
12 conditions in this Chapter 23.45 and Chapter 23.58A.

13 * * *

14 Section 4. Subsection 23.47A.012.A of the Seattle Municipal Code, which section was
15 last amended by Ordinance 124883, is amended as follows:

16 **23.47A.012 Structure height**

17 A. The height limit for structures in NC zones or C zones is 30 feet, 40 feet, 65 feet, 85
18 feet, 125 feet, or 160 feet, as designated on the Official Land Use Map, Chapter 23.32. Structures
19 may not exceed the applicable height limit, except as otherwise provided in this Section
20 23.47A.012.

21 1. In zones with a 30 foot or 40 foot mapped height limit:

22 a. The height of a structure may exceed the otherwise applicable limit by
23 up to 4 feet, subject to subsection 23.47A.012.A.1.c, provided the following conditions are met:

1 1) Either;

2 a) A floor-to-floor height of 13 feet or more is provided for
3 non-residential uses at street level; or

4 b) A residential use is located on a street-level, street-facing
5 facade, provided that the average height of the exterior facades of any portion of a story that is
6 partially below-grade does not exceed 4 feet, measured from existing or finished grade,
7 whichever is less, and the first floor of the structure at or above grade is at least 4 feet above
8 sidewalk grade; and

9 2) The additional height allowed for the structure will not allow an
10 additional story beyond the number that could be built under the otherwise applicable height
11 limit.

12 b. The height of a structure may exceed the otherwise applicable limit by
13 up to 7 feet, subject to subsection 23.47A.012.A.1.c, provided all of the following conditions are
14 met:

15 1) Residential and multipurpose retail sales uses are located in the
16 same structure;

17 2) The total gross floor area of at least one multi-purpose retail
18 sales use exceeds 12,000 square feet;

19 3) A floor-to-floor height of 16 feet or more is provided for the
20 multi-purpose retail sales use at street level;

21 4) The additional height allowed for the structure will not allow an
22 additional story beyond the number that could be built under the otherwise applicable height
23 limit if a floor-to-floor height of 16 feet were not provided at street level; and

1 5) The structure is not allowed additional height under subsection
2 23.47A.012.A.1.a.

3 c. The Director shall reduce or deny the additional structure height
4 allowed by this subsection 23.47A.012.A.1 if the additional height would significantly block
5 views from neighboring residential structures of any of the following: Mount Rainier, the
6 Olympic and Cascade Mountains, the downtown skyline, Green Lake, Puget Sound, Lake
7 Washington, Lake Union, or the Ship Canal.

8 2. For any lot within the designated areas shown on Map A for 23.47A.012, the
9 height limit in NC zones or C zones designated with a 40-foot height limit on the Official Land
10 Use Map may be increased to 65 feet and may contain floor area as permitted for a 65 foot zone,
11 according to Section 23.47A.013, provided that all portions of the structure above 40 feet contain
12 only residential uses, and provided that no additional height is allowed under subsection
13 23.47A.012.A.1.

14

1
2

Map A for 23.47A.012

Areas Where Additional Height is Allowed

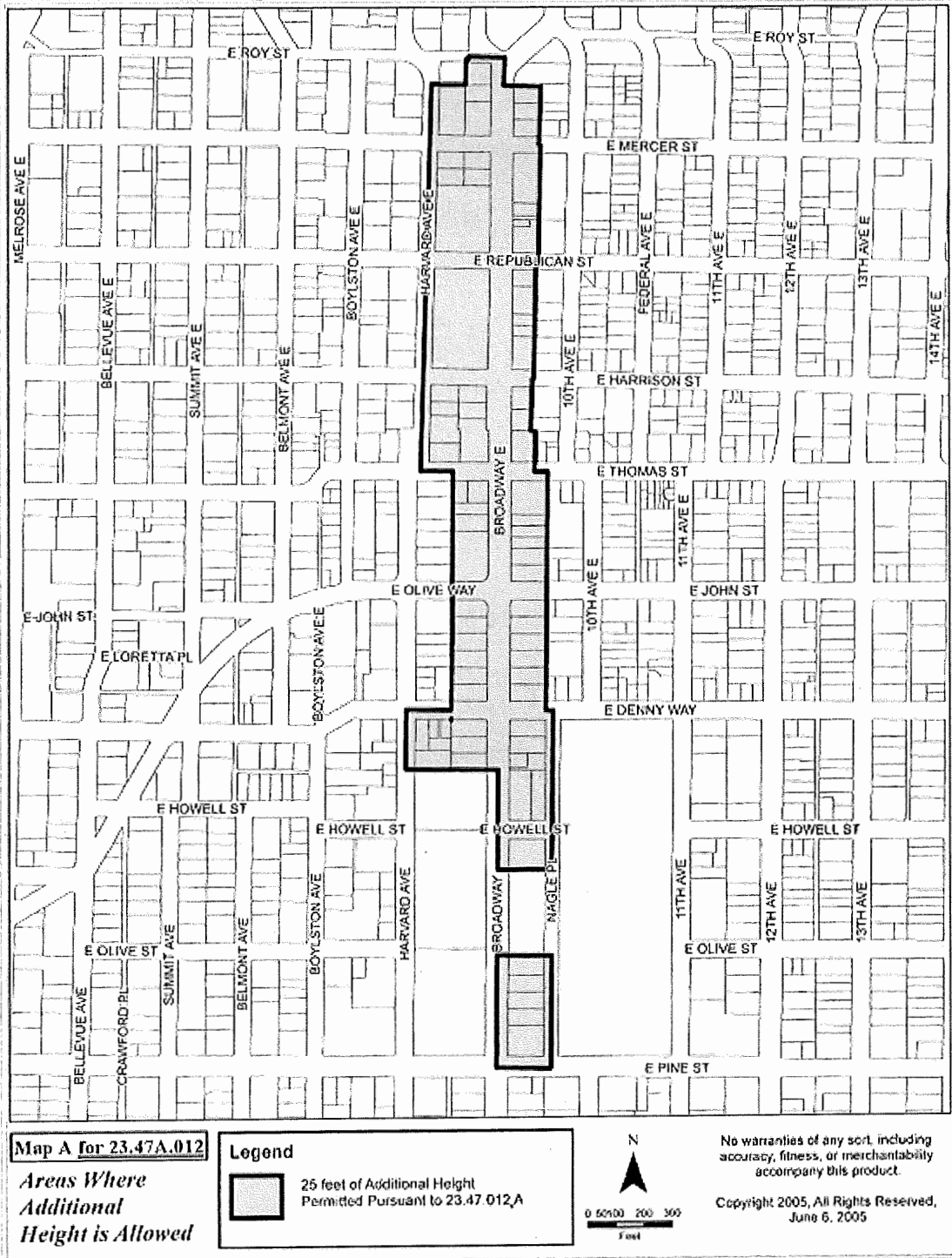

3

1 3. Within the Station Area Overlay District within the University (~~District~~
2 Northwest)) Community Urban Center (~~Village~~)), maximum structure height may be increased
3 to 125 feet when all of the following are met:

4 a. The lot is within two blocks of a planned or existing light rail station;

5 b. The proposed use of the lot is functionally related to other office
6 development, permitted prior to 1971, to have over 500,000 square feet of gross floor area to be
7 occupied by a single entity;

8 c. A transportation management plan for the life of the use includes
9 incentives for light rail and other transit use by the employees of the office use;

10 d. The development shall provide street-level amenities for pedestrians
11 and shall be designed to promote pedestrian interest, safety, and comfort through features such as
12 landscaping, lighting, and transparent facades, as determined by the Director; and

13 e. This subsection 23.47A.012.A.3 can be used only once for each
14 development that is functionally related.

15 4. On a lot containing a peat settlement-prone environmentally critical area, the
16 height of a structure may exceed the otherwise applicable height limit and the other height
17 allowances provided by this Section 23.47A.012 by up to 3 feet. In addition, 3 more feet of
18 height may be allowed for any wall of a structure on a sloped lot, provided that on the uphill
19 sides of the structure, the maximum elevation of the structure height shall be no greater than the
20 height allowed by the first sentence of subsection 23.47A.012.A.4. The Director may apply the
21 allowances in subsection 23.47A.012.A.4 only if the following conditions are met:

22 a. The Director finds that locating a story of parking underground is
23 infeasible due to physical site conditions such as a high water table;

1 b. The Director finds that the additional height allowed for the structure is
2 necessary to accommodate parking located partially below grade that extends no more than 6 feet
3 above existing or finished grade and no more than 3 feet above the highest existing or finished
4 grade along the structure footprint, whichever is lower, as measured to the finished floor level
5 above; and

6 c. Other than the additional story of parking allowed according to
7 subsection 23.47A.012.A.4, the additional height allowed for the structure by subsection
8 23.47A.012.A.4 shall not allow an additional story beyond the number of stories that could be
9 built under the otherwise applicable height limit.

10 5. In zones that are located within the Pike/Pine Conservation Overlay District
11 with a mapped height limit of 65 feet, or with a mapped height limit of 40 feet with provisions
12 allowing for additional height up to 65 feet according to subsection 23.47A.012.A.2, the
13 provisions of Section 23.73.014 apply.

14 * * *

15 Section 5. Section 23.47A.013 of the Seattle Municipal Code, last amended by Ordinance
16 124843, is amended as follows:

17 **23.47A.013 Floor area ratio**

18 A. Floor area ratio (FAR) limits apply to all structures and lots in all NC zones and C
19 zones.

20 1. All gross floor area not exempt under subsection 23.47A.013.D is counted
21 against the maximum gross floor area allowed by the permitted FAR.

1 2. If there are multiple structures on a lot, the highest FAR limit applicable to any
2 structure on the lot applies to the combined non-exempt gross floor area of all structures on the
3 lot, subject to subsection 23.47A.013.A.4.

4 3. Except as provided in subsection 23.47A.013.D.7, parking that is within or
5 covered by a structure or portion of a structure and that is within a story that is not underground
6 shall be included in gross floor area calculations.

7 4. If a lot is in more than one zone, the FAR limit for each zone applies to the
8 portion of the lot located in that zone, and the floor area on the portion of the lot with the lower
9 FAR limit may not exceed the amount that would be permitted if it were a separate lot. If a lot is
10 in both a multifamily zone and a commercial zone, the floor area on the commercial portion of
11 the lot may not exceed the maximum that would be allowed if the commercial portion of the lot
12 were a separate lot.

13 B. Except as provided in subsections 23.47A.013.C, 23.47A.013.D, 23.47A.013.E,
14 23.47A.013.F, and 23.47A.013.G, maximum FAR allowed in C zones and NC zones is shown in
15 Table A for 23.47A.013, provided that if the commercial zone designation includes an incentive
16 zoning suffix, then the applicant shall comply with Chapter 23.58A, Incentive Provisions, to
17 obtain gross floor area exceeding that allowed by the FAR shown in the suffix designation.

18

Table A for 23.47A.013((?)) Maximum Floor Area Ratio (FAR) outside of the Station Area Overlay District						
	Height ((Limit)) limit (in feet)					
	30	40	65	85	125	160
	Maximum FAR					
1. Total FAR permitted on a lot that is solely occupied by residential use or non-residential use.	2.25	3	4.25	4.5	5	5
2. Total permitted for any single use within a mixed-use structure.	n/a	n/a	4.25	4.5	5	5
3. Total FAR permitted for all uses on a lot that is occupied by a mix of uses, provided that the FAR limit for either all residential uses or the FAR limit for all non-residential uses shall not exceed the FAR limit established in Row 1.	2.5	3.25	4.75	6	6	7

1

2

C. Maximum FAR allowed in NC zones or C zones within the Station Area Overlay

3

District is shown in Table B for 23.47A.013 provided that, if the commercial zone designation

4

includes an incentive zoning suffix, then the applicant shall comply with Chapter 23.58A,

5

Incentive Provisions, to obtain gross floor exceeding that allowed by the FAR shown in the

6

suffix designation.

Table B for 23.47A.013((?)) Maximum Floor Area Ratio (FAR) in the Station Area Overlay District						
	Height ((Limit)) limit (in feet)					
	30((?))	40((?))	65((?))	85((?))	125((?))	160((?))
Maximum FAR	3	4	5.75	6	6	7

7

8

D. The following gross floor area is not counted toward maximum FAR:

9

1. All underground stories or portions of stories;

10

2. All portions of a story that extend no more than 4 feet above existing or

11

finished grade, whichever is lower, excluding access;

1 3. Gross floor area of a transit station, including all floor area open to the general
2 public during normal hours of station operation but excluding retail or service establishments to
3 which public access is limited to customers or clients, even where such establishments are
4 primarily intended to serve transit riders;

5 4. Within the South Lake Union Urban Center, gross floor area occupied by
6 mechanical equipment located on the roof of a structure;

7 5. Within the South Lake Union Urban Center, mechanical equipment that is
8 accessory to a research and development laboratory, up to 15 percent of the gross floor area of a
9 structure. The allowance is calculated on the gross floor area of the structure after all space
10 exempt under this subsection 23.47A.013.D is deducted; ~~((and))~~

11 6. Within ~~((the))~~ First Hill ~~((Urban Center Village))~~, on lots zoned NC3, with a
12 160 foot height limit, all gross floor area occupied by a residential use ~~((-))~~ ;

13 7. On a lot containing a peat settlement-prone environmentally critical area,
14 above-grade parking within or covered by a structure or portion of a structure if the Director
15 finds that locating a story of parking below grade is infeasible due to physical site conditions
16 such as a high water table, if either:

17 a. the above-grade parking extends no more than 6 feet above existing or
18 finished grade and no more than 3 feet above the highest existing or finished grade along the
19 structure footprint, whichever is lower, as measured to the finished floor level or roof above,
20 pursuant to subsection 23.47A.012.A.5; or

21 b. all of the following conditions are met:

22 1) ~~((no))~~ No above-grade parking is exempted by subsection
23 23.47A.013.D.7.a;

1 2) ~~((the))~~ The parking is accessory to a residential use on the lot;

2 3) ~~((total))~~ Total parking on the lot does not exceed one space for
3 each residential dwelling unit plus the number of spaces required for non-residential uses; and

4 4) ~~((the))~~ The amount of gross floor area exempted by this
5 subsection 23.47A.013.D.7.b does not exceed 25 percent of the area of the lot in zones with a
6 height limit less than 65 feet, or 50 percent of the area of the lot in zones with a height limit 65
7 feet or greater ~~((,))~~ ; and

8 8. Rooftop greenhouse areas meeting the standards of subsection 23.47A.012.C.6
9 and 23.47A.012.C.7.

10 E. Within the Station Area Overlay District within the University ~~((District Northwest))~~
11 Community Urban Center ~~((Village))~~, for office structures permitted prior to 1971, the area of
12 the lot for purposes of calculating permitted FAR is the tax parcel created prior to the adoption of
13 Ordinance 121846 on which the existing structure is located, provided the office structure is to
14 be part of a functionally related development occupied by a single entity with over 500,000
15 square feet of area in office use. The floor area of above grade pedestrian access is exempt from
16 the FAR calculations of this subsection 23.47A.013.E, and the maximum permitted FAR is 8.

17 F. Within the West Seattle Junction Hub Urban Village, on lots zoned NC3 85(4.75), the
18 total permitted FAR for all uses within a mixed use structure containing residential and non-
19 residential uses is 5.5.

20 G. Within the portion of the Greenwood Residential Urban Village on lots zoned NC2 40
21 that are located abutting NW 85th Street between 1st Avenue NW and 3rd Avenue NW, the total
22 permitted FAR within a mixed use structure containing residential and non-residential uses is 4.

23 H. Minimum FAR

1 1. A minimum FAR shown in Table C for 23.47A.013 is required whenever more
2 than 1,000 square feet of gross floor area is added to or removed from a lot located in:

3 a. ~~((located in))~~ a pedestrian-designated zone in an Urban Center, Urban
4 Village, or Station Area Overlay District; or

5 b. ~~((located in))~~ the Northgate Overlay District and abutting a Major
6 Pedestrian Street as shown on Map A for ~~((subsection))~~ 23.71.004.

Table C for 23.47A.013(~~(?)~~)

Minimum Floor Area Ratio (FAR)

Height ((Limit)) <u>limit (in feet)</u>	30 ((feet))	40 ((feet))	65 ((feet))	85 ((feet))	125 ((feet))	160 ((feet))
Minimum FAR	1.5	1.5	2	2	2.5	2.5

7
8 2. The minimum FAR requirement provided in subsection 23.47A.013.H.1 does
9 not apply if:

10 a. additional floor area is added to an existing structure on a lot that is
11 nonconforming with respect to the minimum FAR shown in Table C for 23.47A.013;

12 b. the lot is larger than five acres;

13 c. all existing gross floor area is demolished to create a vacant lot; or

14 d. parks and open space is the principal use of the lot.

15 3. Portions of the lot designated as a steep slope, wetland, or riparian corridor or
16 as a buffer to one of these areas, as defined in Chapter 25.09, shall not be included when
17 calculating lot size for the purpose of determining the minimum FAR requirement provided in
18 subsection 23.47A.013.H.1.

19 4. The Director, in consultation with the Director of the Department of
20 Neighborhoods, may waive the minimum FAR requirement provided in subsection

1 23.47A.013.H.1 for lots that contain a designated ((~~landmark~~)) Landmark, or for lots within a
2 Landmark District pursuant to Title 25 or within a Special Review District pursuant to Chapter
3 23.66, if the Director determines a waiver is necessary to preserve the integrity of a ((~~landmark~~))
4 Landmark or meet adopted District design and development guidelines.

5 5. The Director may waive the minimum FAR requirement provided in subsection
6 23.47A.013.H.1 for lots within the Pike/Pine Conservation Overlay District pursuant to Chapter
7 23.32, if the Director determines that the proposed development promotes neighborhood
8 conservation objectives.

9 6. The following gross floor area is not counted toward the minimum FAR
10 requirement provided in subsection 23.47A.013.H.1:

- 11 a. Gross floor area below grade; and
- 12 b. Gross floor area containing parking.

13 7. In zones with an incentive zoning suffix, the minimum FAR requirement is the
14 FAR indicated by the incentive zoning suffix if that FAR is less than the FAR required by
15 subsection 23.47A.013.H.1.

16 Section 6. Section 23.49.056 of the Seattle Municipal Code, last amended by Ordinance
17 124680, is amended as follows:

18 **23.49.056 Downtown Office Core 1 (DOC1), Downtown Office Core 2 (DOC2), and**
19 **Downtown Mixed Commercial (DMC) street facade, landscaping, and street setback**
20 **requirements**

21 Standards are established in this Section 23.49.056 for DOC1, DOC2, and DMC zones, for the
22 following elements:

23 ((~~minimum~~)) Minimum facade heights,

- 1 ((setback)) Setback limits,
- 2 ((facade)) Facade transparency,
- 3 ((blank)) Blank facade limits,
- 4 ((street)) Street trees, and
- 5 ((setback)) Setback and landscaping requirements in the Denny Triangle ((~~Urban Center~~
- 6 ~~Village~~)).

7 These standards apply to each lot line that abuts a street designated on Map 1F or another map
8 identified in a note to Map 1F as having a pedestrian classification, except lot lines of open space
9 TDR sites, and apply along other lot lines and to circumstances as expressly stated in this Section
10 23.49.056. The standards for each street frontage shall vary according to the pedestrian
11 classification of the street on Map 1F or another map identified in a note to Map 1F and to
12 whether property line facades are required by Map 1H. Standards for street landscaping and
13 setback requirements in subsection 23.49.056.F also apply along lot lines abutting streets in the
14 Denny Triangle ((~~Urban Center Village~~)), as shown on Map A for 23.49.056.

15 **Map A for 23.49.056: Denny Triangle ((~~Urban Center Village~~)**

**Map A for 23.49.056:
Denby Triangle Urban Center Village**

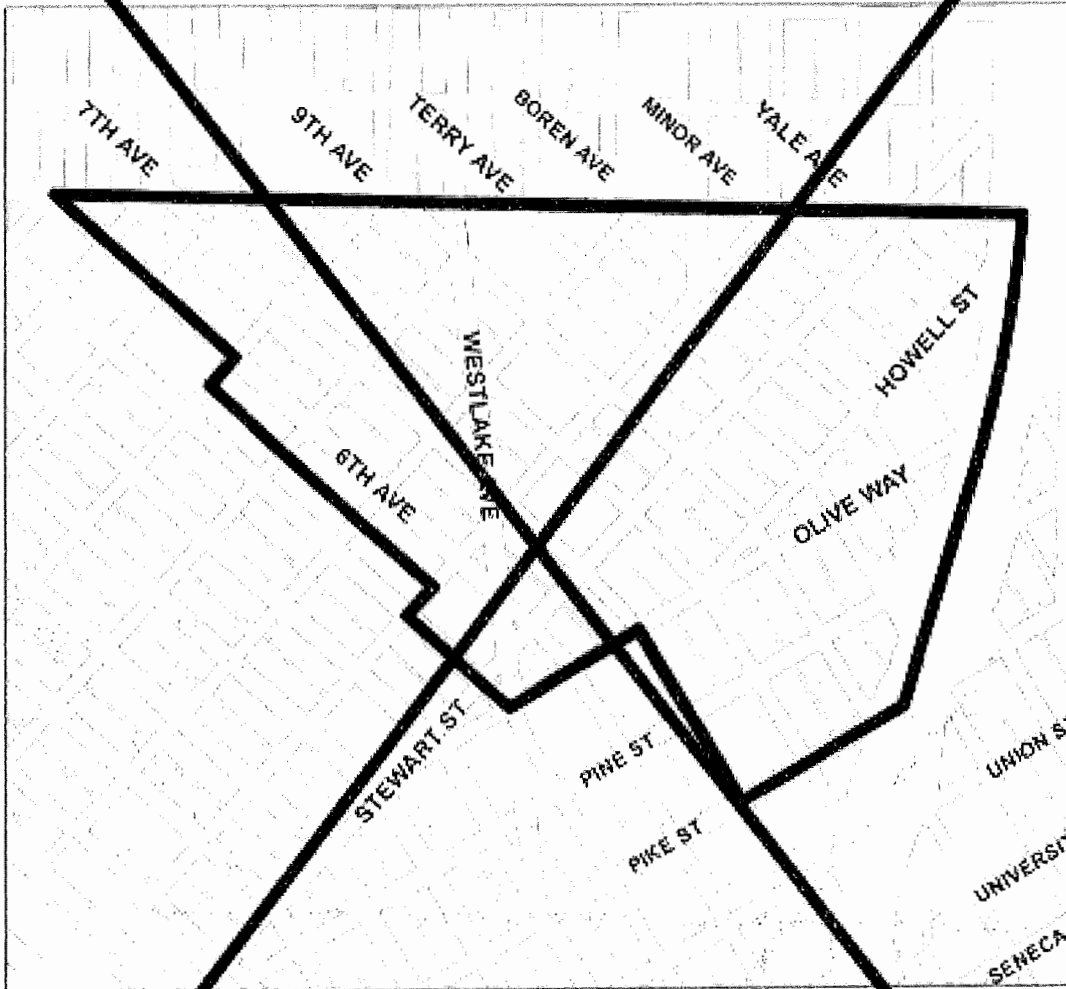

 Denby Triangle Urban Center Village Boundary

No warranties of any sort, including
accuracy, fitness, or merchantability,
are made by this product.
Copyright 2012. All Rights Reserved.
City of Seattle



1
2

Map A for 23.49.056 Denny Triangle

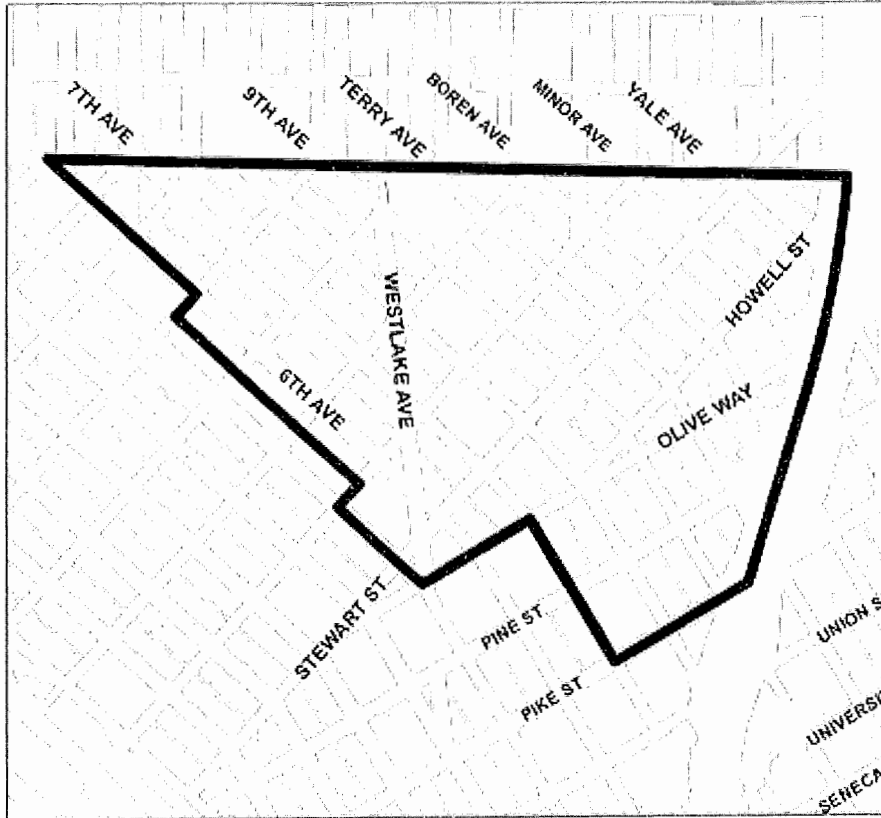

— Denny Triangle Boundary

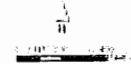

No warranties of any sort, including accuracy, fitness or merchantability, accompany this product.
Copyright 2012. All Rights Reserved
City of Seattle

1

2

1 A. Minimum facade height

2 1. Minimum facade height(s) are prescribed in Table A for 23.49.056 and Exhibit
3 A for 23.49.056, but minimum facade heights do not apply if all portions of the structure are
4 lower than the elevation of the required minimum facade height.

5 ~~((Table A for 23.49.056~~
6 ~~Minimum Façade Height))~~

<u>Table A for 23.49.056</u> <u>Minimum Façade Height</u>	
Street classification	Minimum facade height* within designated zone
Streets requiring property line facades	DOC1, DOC2, DMC: 35 feet
Class I pedestrian streets	DOC 1, DOC 2: 35 feet DMC: 25 feet
Class II pedestrian streets	DOC 1, DOC 2: 25 feet DMC: 15 feet
Designated green streets	DOC1, DOC2, DMC: 25 feet
<u>Footnote to Table A for 23.49.056</u> *Except as provided in subsection 23.49.056.A.2 regarding view corridor requirements.	

7
8 2. On designated view corridors specified in Section 23.49.024, the minimum
9 facade height is the maximum height permitted in the required setback, if it is less than the
10 minimum facade height required in subsection 23.49.056.A.1.

1 **Exhibit A for 23.49.056**

2 **Minimum Facade Height**

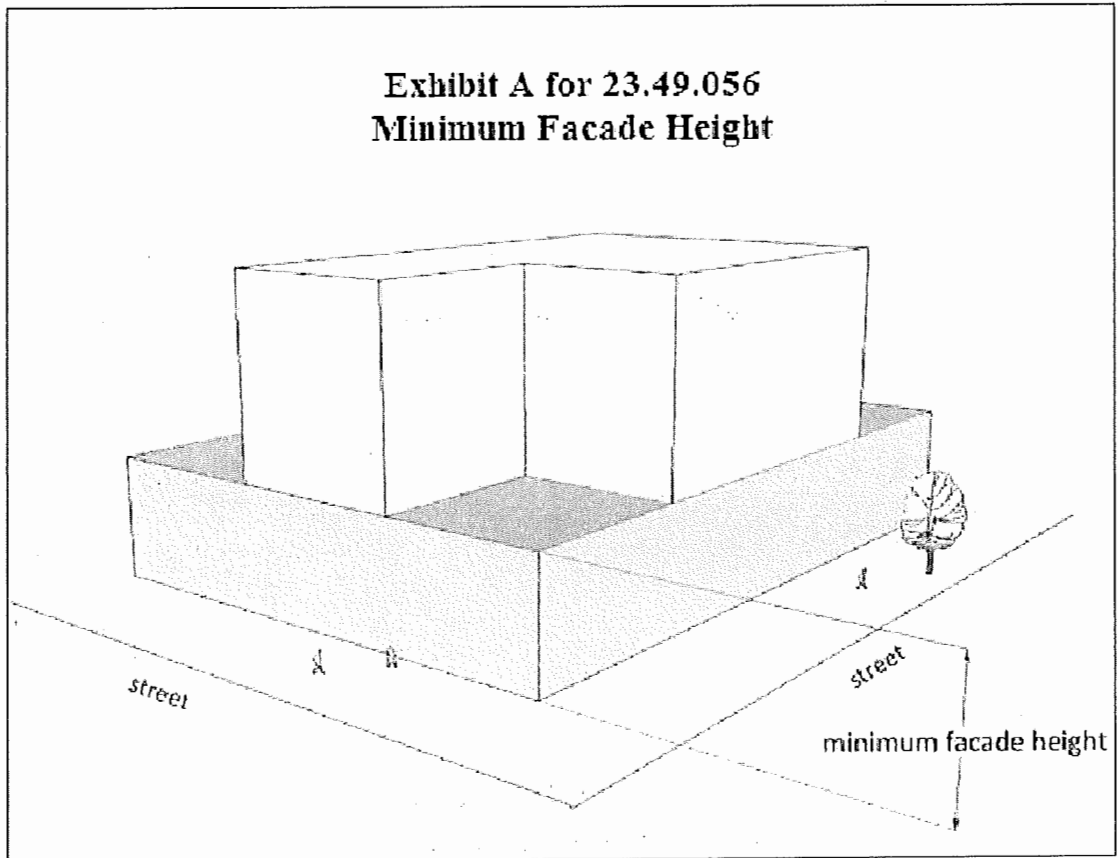

3

4 **B. Facade setback limits**

5 1. Setback limits for property line facades. The following setback limits apply to
6 all streets designated on Map 1H as requiring property line facades, except as specified in
7 subsection 23.49.056.B.1.d.

8 a. The facades of structures 15 feet or less in height shall be located within
9 2 feet of the street lot line.

10 b. Structures greater than 15 feet in height are governed by the following
11 criteria:

1 1) No setback limits apply up to an elevation of 15 feet above
2 sidewalk grade.

3 2) Between the elevations of 15 and 35 feet above sidewalk grade,
4 the facade shall be located within 2 feet of the street lot line, except that:

5 a) Any exterior public open space that satisfies the
6 Downtown Amenity Standards, whether it receives a bonus or not, and any outdoor common
7 recreation area required for residential uses, is not considered part of the setback.

8 b) Setbacks between the elevations of 15 and 35 feet above
9 sidewalk grade at the street lot line are permitted according to the following standards, as
10 depicted in Exhibit B for 23.49.056:

11 i. The maximum setback is 10 feet.

12 ii. The total area of a facade that is set back more
13 than 2 feet from the street lot line shall not exceed 40 percent of the total facade area between the
14 elevations of 15 and 35 feet.

15 iii. No setback deeper than 2 feet shall be wider
16 than 20 feet, measured parallel to the street lot line.

17 iv. The facade of the structure shall return to within
18 2 feet of the street lot line between each setback area for a minimum of 10 feet. Balcony railings
19 and other nonstructural features or walls are not considered the facade of the structure.

20

1 **Exhibit B for 23.49.056**

2 **Exception to Maximum Setback Limits**

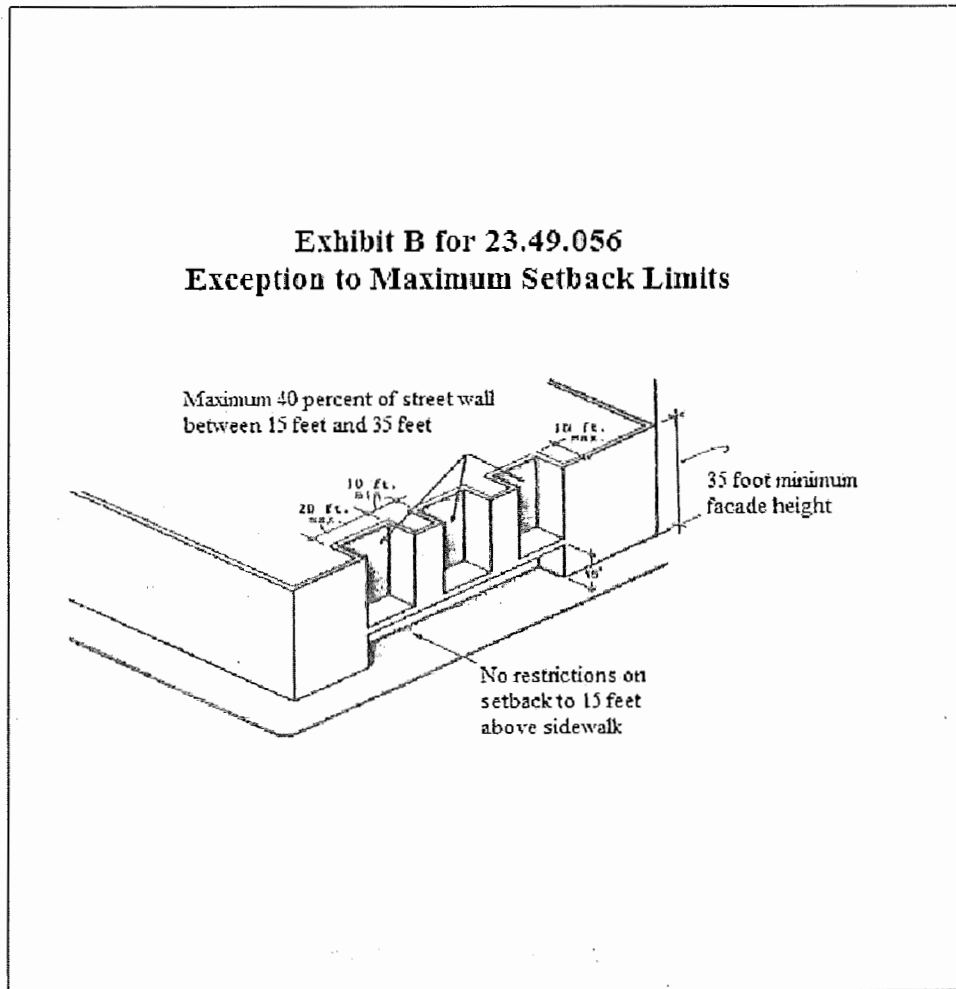

3

4

5

6

7

8

9

10

11

c. If sidewalk widening is required by Section 23.49.022, setback

standards shall be measured to the line established by the new sidewalk width rather than the street lot line.

d. In the DMC 160 zone, on lots that abut Alaskan Way, as an alternative

to the standards for required property line facades in subsections 23.49.056.B.1.a,

23.49.056.B.1.b, and 23.49.056.B.1.c, a continuous setback of up to 16 feet from the lot line

abutting Alaskan Way is allowed for the street-facing facade. If the alternative setback allowed

by this subsection 23.49.056.B.1.d is provided, the setback area shall be used for outdoor uses

1 related to abutting street-level uses, for landscaped open space, for a partially above-grade story
2 that meets the conditions of subsection 23.49.011.B.1.u, or to widen the abutting sidewalk for
3 pedestrian use.

4 2. General (~~(Setback Limits)~~) setback limits. The following setback limits apply
5 on streets not requiring property line facades, as shown on Map 1H:

6 a. The portion of a structure subject to setback limits shall vary according
7 to the structure height and required minimum facade height, as follows:

8 1) Except as provided in subsection 23.49.056.B.2.a.3, if the
9 structure is greater than 15 feet in height, the setback limits apply to the facade between an
10 elevation of 15 feet above sidewalk grade and the minimum facade height established in
11 subsection 23.49.056.A and illustrated in Exhibit C for 23.49.056.

12 2) If the entire structure is 15 feet or less in height, the setback
13 limits apply to the entire street-facing facade.

14 3) If the minimum facade height is 15 feet, the setback limits apply
15 to the portion of the street-facing facade that is 15 feet or less in height.

16

1 **Exhibit C for 23.49.056**

2 **Application of Maximum Setback Limits**

**Exhibit C for 23.49.056
Application of Maximum Setback Limits**

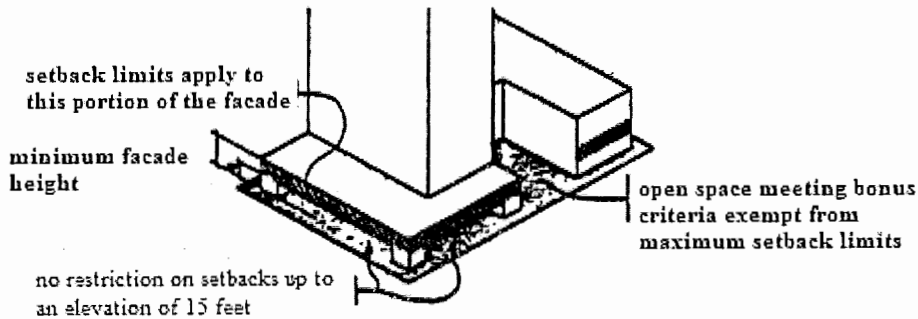

3

4

5

6

7

8

9

10

11

12

b. The maximum area of all setbacks between the street lot line and facade along each street frontage of a lot shall not exceed the area derived by multiplying the averaging factor by the width of the street frontage of the structure along that street (see Exhibit D for 23.49.056). The averaging factor is five on Class I pedestrian streets and ten on Class II pedestrian streets and designated green streets.

c. The maximum width, measured along the street lot line, of any setback area exceeding a depth of 15 feet from the street lot line shall not exceed 80 feet, or 30 percent of the lot frontage on that street, whichever is less. (See Exhibit D for 23.49.056.)

1 **Exhibit D for 23.49.056**

2 **Maximum Width of Setback**

**Exhibit D of 23.49.056
Maximum Width of Setback**

Maximum width
80 feet or 30% of
lot frontage
when setback
exceeds 15 feet

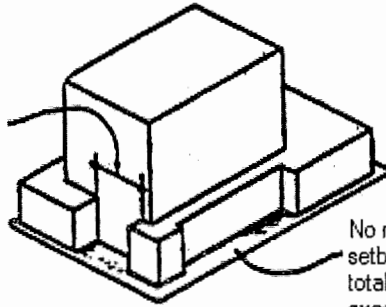

No maximum width when
setback is less than 15 feet;
total area of setback shall not
exceed street frontage
dimension times the averaging
factor

3

4

5

6

7

d. The maximum setback of the facade from the street lot lines at intersections is 10 feet. The minimum distance the facade must conform to this limit is 20 feet along each street. (See Exhibit E for 23.49.056.)

1 **Exhibit E for 23.49.056**

2 **Maximum Setback at Intersections**

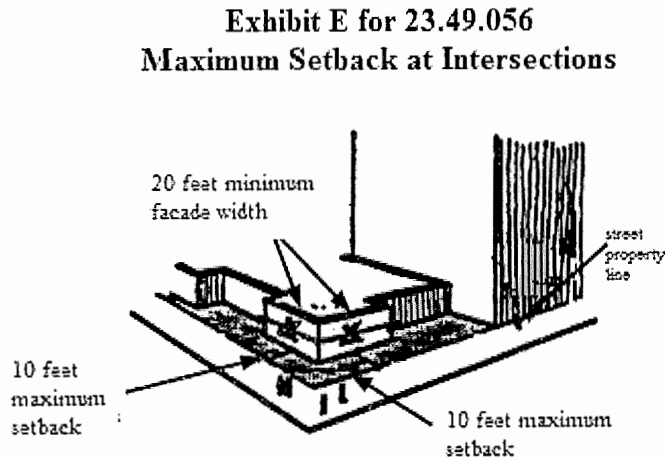

3

4 e. Any exterior public open space that meets the Downtown Amenity
5 Standards, whether it receives a bonus or not, and any outdoor common recreation area required
6 for residential uses, is not considered part of a setback. (See Exhibit C for 23.49.056.)

7 f. If a sidewalk is widened into the lot as a condition to development,
8 setback standards shall be measured to the line established by the new sidewalk width rather than
9 the street lot line.

10 C. Facade ((~~Transparency Requirements~~)) transparency requirements

11 1. Facade transparency requirements apply to the area of the facade between 2
12 feet and 8 feet above the sidewalk, except that if the slope along the street frontage of the facade
13 exceeds 7.5 percent, the transparency requirements apply to the area of the facade between 4 feet
14 and 8 feet above sidewalk grade. Only clear or lightly tinted glass in windows, doors, and display
15 windows is considered to be transparent. Transparent areas shall allow views into the structure or
16 into display windows from the outside.

1 2. Facade transparency requirements do not apply to portions of structures in
2 residential use.

3 3. If the transparency requirements of this subsection 23.49.056.C are inconsistent
4 with the glazing limits in the Energy Code, this subsection 23.49.056.C applies to the extent
5 permitted by applicable law.

6 4. Transparency requirements are as follows:

7 a. Class I pedestrian streets and designated green streets: A minimum of
8 60 percent of the street-level, street-facing facade shall be transparent.

9 b. Class II pedestrian streets: A minimum of 30 percent of the street-level,
10 street-facing facade shall be transparent.

11 c. Where the slope along the street frontage of the facade exceeds 7.5
12 percent, the required amount of transparency shall be reduced to 50 percent on Class I pedestrian
13 streets and designated green streets and 25 percent on Class II pedestrian streets.

14 D. Blank ((~~Facade Limits~~)) facade limits

15 1. General ((~~Provisions~~)) provisions

16 a. Blank facade limits apply to the area of the facade between 2 feet and 8
17 feet above the sidewalk, except that where the slope along the street frontage of the facade
18 exceeds 7.5 percent, blank facade limits apply to the area of the facade between 4 feet and 8 feet
19 above sidewalk grade.

20 b. Any portion of a facade that is not transparent shall be considered to be
21 a blank facade.

22 c. Blank facade limits do not apply to portions of structures in residential
23 use.

1 2. Blank ((~~Facade Limits~~)) facade limits for Class I ((~~Pedestrian Streets~~))
2 pedestrian streets and ((~~Designated Green Streets~~)) designated green streets

3 a. Blank facades shall be no more than 15 feet wide except segments with
4 garage doors may exceed a width of 15 feet and may be as wide as the driveway plus 5 feet.
5 Blank facade segment width may be increased to 30 feet if the Director in a Type I decision
6 determines that the facade segment is enhanced by features with visual interest such as
7 architectural detailing, artwork, landscaping, or similar features.

8 b. Any blank segments of the facade shall be separated by transparent
9 areas at least 2 feet wide.

10 c. The total width of all blank facade segments, including garage doors,
11 shall not exceed 40 percent of the street-facing facade of the structure on each street frontage, or
12 50 percent if the slope of the street frontage of the facade exceeds 7.5 percent.

13 3. Blank ((~~Facade Limits~~)) facade limits for Class II ((~~Pedestrian Streets~~))
14 pedestrian streets

15 a. Blank ((~~façade~~)) facade segments shall be no more than 30 feet wide,
16 except for garage doors, which may exceed 30 feet. Blank facade segment width may be
17 increased to 60 feet if the Director in a Type I decision determines that the facade segment is
18 enhanced by architectural detailing, artwork, landscaping, or similar features that have visual
19 interest. The width of garage doors shall be limited to the width of the driveway plus 5 feet.

20 b. Any blank segments of the facade shall be separated by transparent
21 areas at least 2 feet wide.

1 c. The total of all blank facade segments, including garage doors, shall not
2 exceed 70 percent of the street facade of the structure on each street frontage; or 75 percent if the
3 slope of the street frontage of the facade exceeds 7.5 percent.

4 E. Street (~~(Tree Requirements)~~) tree requirements. Street trees are required on all streets
5 that have a pedestrian classification and abut a lot. If areaways are located beneath the sidewalk,
6 the street trees shall be planted in below-grade containers with provisions for watering the trees.
7 Street trees shall be planted according to street tree planting standards in the Right-of-Way
8 Improvements Manual.

9 F. Setback and landscaping requirements for lots located within the Denny Triangle
10 (~~(Urban Center Village)~~)

11 1. Landscaping in the street right-of-way for all streets other than those with green
12 street plans approved by Director's Rule. All new development in DMC zones in the Denny
13 Triangle (~~(Urban Center Village)~~), as shown on Map A for 23.49.056, shall provide landscaping
14 in the sidewalk area of the street right-of-way, except on streets with a green street plan approved
15 by Director's Rule. The square footage of landscaped area provided shall be at least 1.5 times the
16 length of the street lot line (in linear feet). The following standards apply to the required
17 landscaped area:

18 a. The landscaped area shall be at least 18 inches wide and shall be located
19 in the public right-of-way along the entire length of the street lot line, except for building
20 entrances, vehicular access or other connections between the sidewalk and the lot, provided that
21 the exceptions may not exceed 50 percent of the total length of the street lot line(s).

1 b. As an alternative to locating the landscaping at the street lot line, all or a
2 portion of the required landscaped area may be provided in the sidewalk area within 5 feet of the
3 curb line.

4 c. Landscaping provided within 5 feet of the curb line shall be located and
5 designed in relation to the required street tree planting and be compatible with use of the curb
6 lane for parking and loading.

7 d. All plant material shall be planted directly in the ground or in
8 permanently installed planters if planting in the ground is not feasible. A minimum of 50 percent
9 of the plant material shall be perennial.

10 2. Landscaping on a designated green street. If required landscaping is on a
11 designated green street with a green street plan approved by Director's Rule, the planting shall be
12 consistent with designs identified in that green street plan.

13 3. Landscaping in setbacks

14 a. In the Denny Triangle (~~Urban Center Village~~), as shown on Map A
15 for 23.49.056, at least 20 percent of the total square footage of all areas abutting the street lot line
16 that are not covered by a structure, have a depth of 10 feet or more from the street lot line and are
17 larger than 300 square feet, shall be landscaped. Any area under canopies or marquees is
18 considered uncovered. Any setback provided to meet the minimum sidewalk widths established
19 by Section 23.49.022 is exempt from the calculation of the area to be landscaped.

20 b. All plant material shall be planted directly in the ground or in
21 permanently installed planters if planting in the ground is not feasible. A minimum of 50 percent
22 of the plant material shall be perennial and shall include trees if a contiguous area, all or a
23 portion of which is landscaped pursuant to subsection 23.49.056.F.1.a, exceeds 600 square feet.

1 4. Terry and 9th Avenues (~~(green-street))~~ Green Street setbacks

2 a. In addition to the requirements of subsections 23.49.056.F.2 and

3 23.49.056.F.3, a 2 foot wide setback from the street lot line is required along the Terry and 9th

4 Avenue Green Streets within the Denny Triangle (~~(Urban Center Village))~~ as shown on Map A

5 for 23.49.056. The Director may allow averaging of the setback requirement of this subsection

6 23.49.056.F.4.a to provide greater conformity with an approved green street plan.

7 b. Fifty percent of the setback area shall be landscaped.

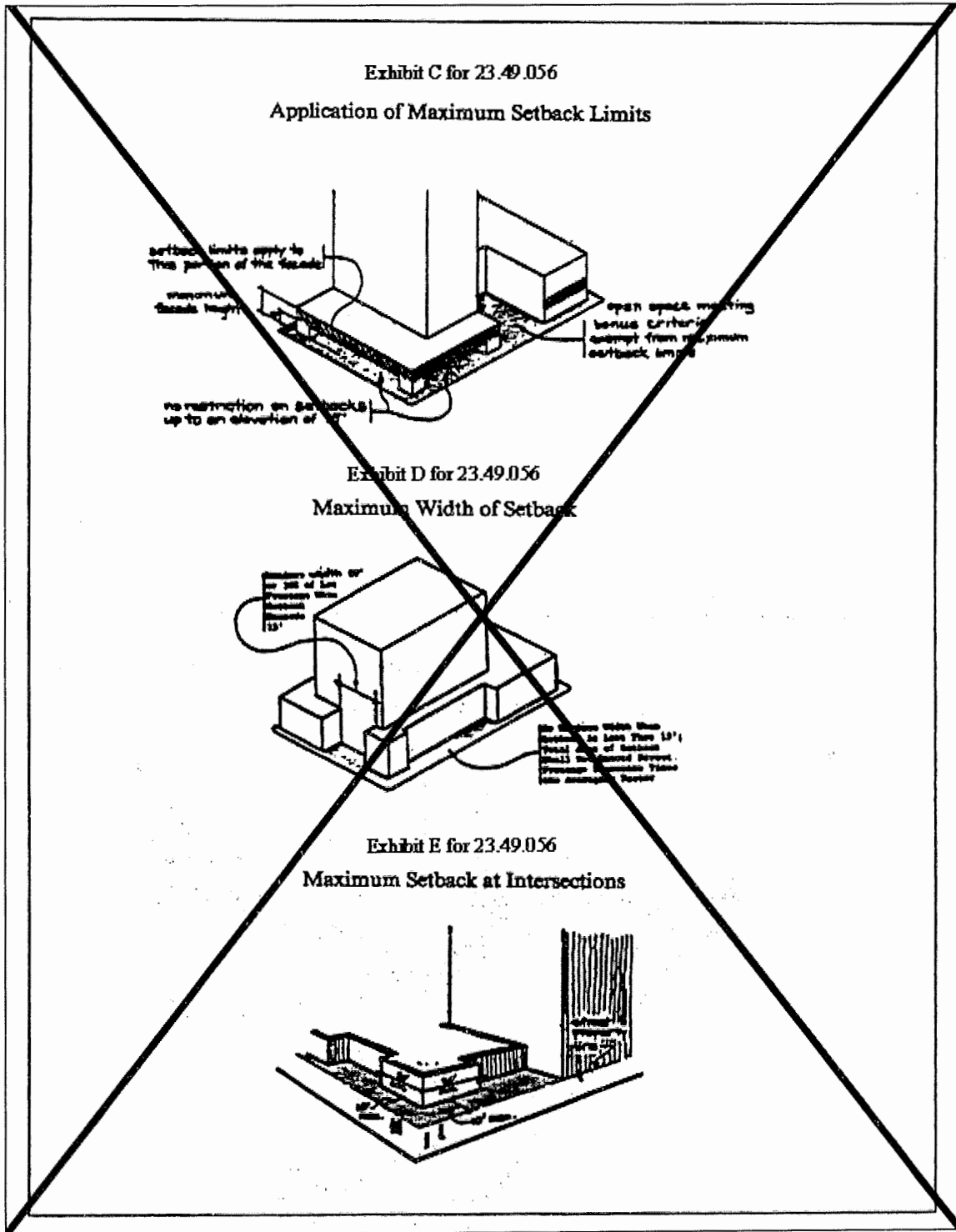

1

2 ((Exhibits C, D, and E for 23.49.056))

3

1
2
3
4
5
6
7
8
9
10
11
12
13
14
15
16
17
18
19
20
21
22
23

Section 7. Subsection 23.49.058.F of the Seattle Municipal Code, which section was last amended by 124680, is amended as follows:

**23.49.058 Downtown Office Core 1 (DOC1), Downtown Office Core 2 (DOC2), and
Downtown Mixed Commercial (DMC) upper-level development standards**

* * *

F. Tower spacing for all structures over 160 feet in height in those DMC zoned areas specified below:

1. For the purposes of this Section 23.49.058, no separation is required:

- a. between structures on different blocks, except as may be required by view corridor or designated green street setbacks (($\frac{1}{2}$)) ; or
- b. from a structure on the same block that is not located in a DMC zone; or
- c. from a structure allowed pursuant to the Land Use Code in effect prior to May 12, 2006; or
- d. from a structure on the same block that is 160 feet in height or less, excluding rooftop features permitted above the applicable height limit for the zone pursuant to Section 23.49.008; or
- e. from a structure in a DMC 160 zone that gains additional height through subsection 23.49.008.E.

2. Except as otherwise provided in this subsection 23.49.058.F, in the DMC 240/290-400 zone located between Stewart Street, Union Street, Third Avenue, and First Avenue, if any part of a tower exceeds 160 feet in height, then all portions of the tower that are above 125 feet in height shall be separated from any other existing tower that is above 160 feet in

1 height, and the minimum separation required between towers from all points above the height of
2 125 feet in each tower is 200 feet.

3 3. Except as otherwise provided in this subsection 23.49.058.F, in the DMC zone
4 with a mapped height limit of more than 160 feet located either in ~~((the))~~ Belltown ~~((Urban~~
5 ~~Center Village))~~, as shown on Map A for 23.49.058, or south of Union Street, if any part of a
6 tower exceeds 160 feet in height, then all portions of the tower that are above 125 feet in height
7 must be separated from any other existing tower that is above 160 feet in height, and the
8 minimum separation required between towers from all points above the height of 125 feet in
9 each tower is 80 feet.

10

- 1 **Map A for 23.49.058((:))**
- 2 **Belltown ((Urban Center Village))**

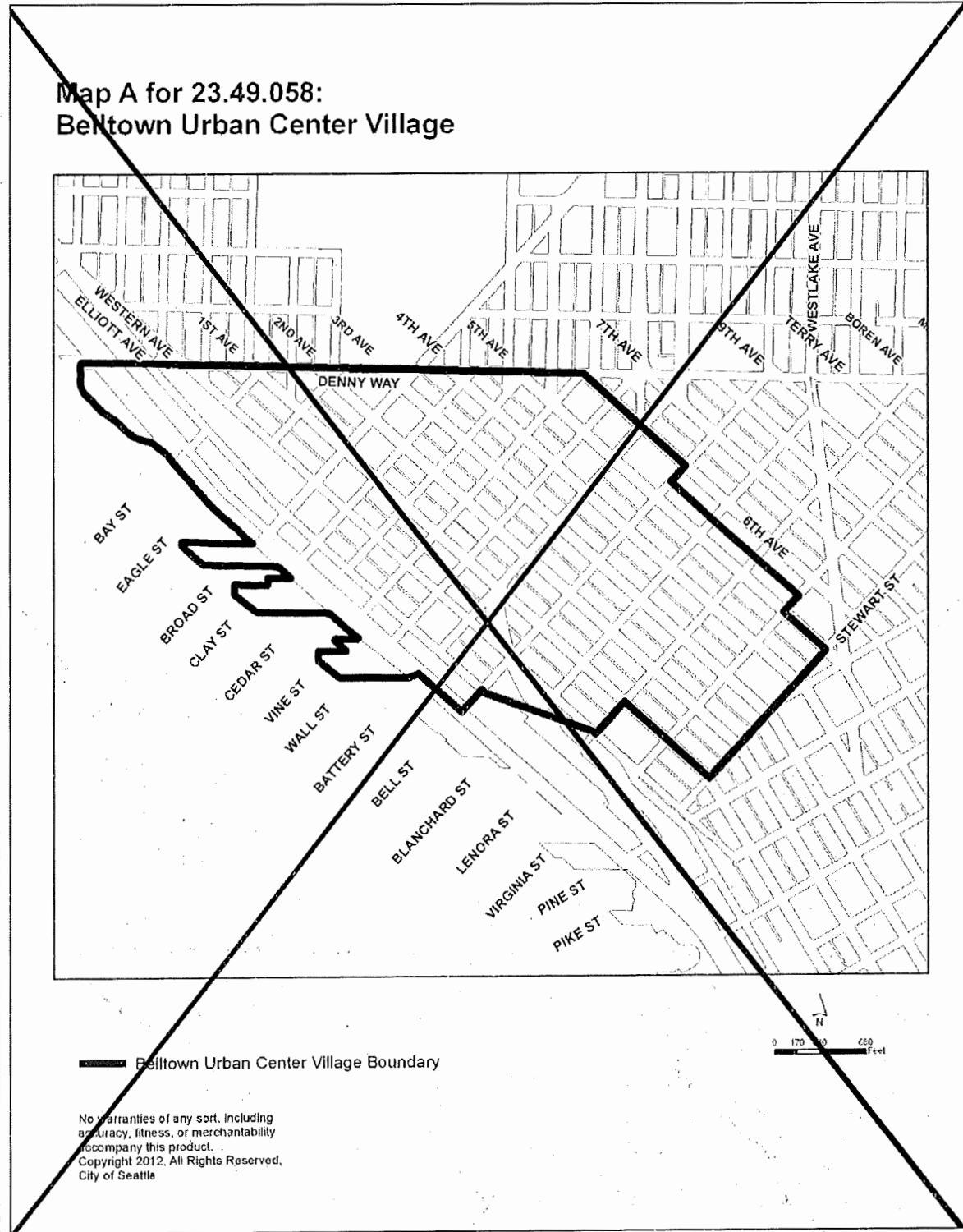

3

Map A for 23.49.058 Belltown

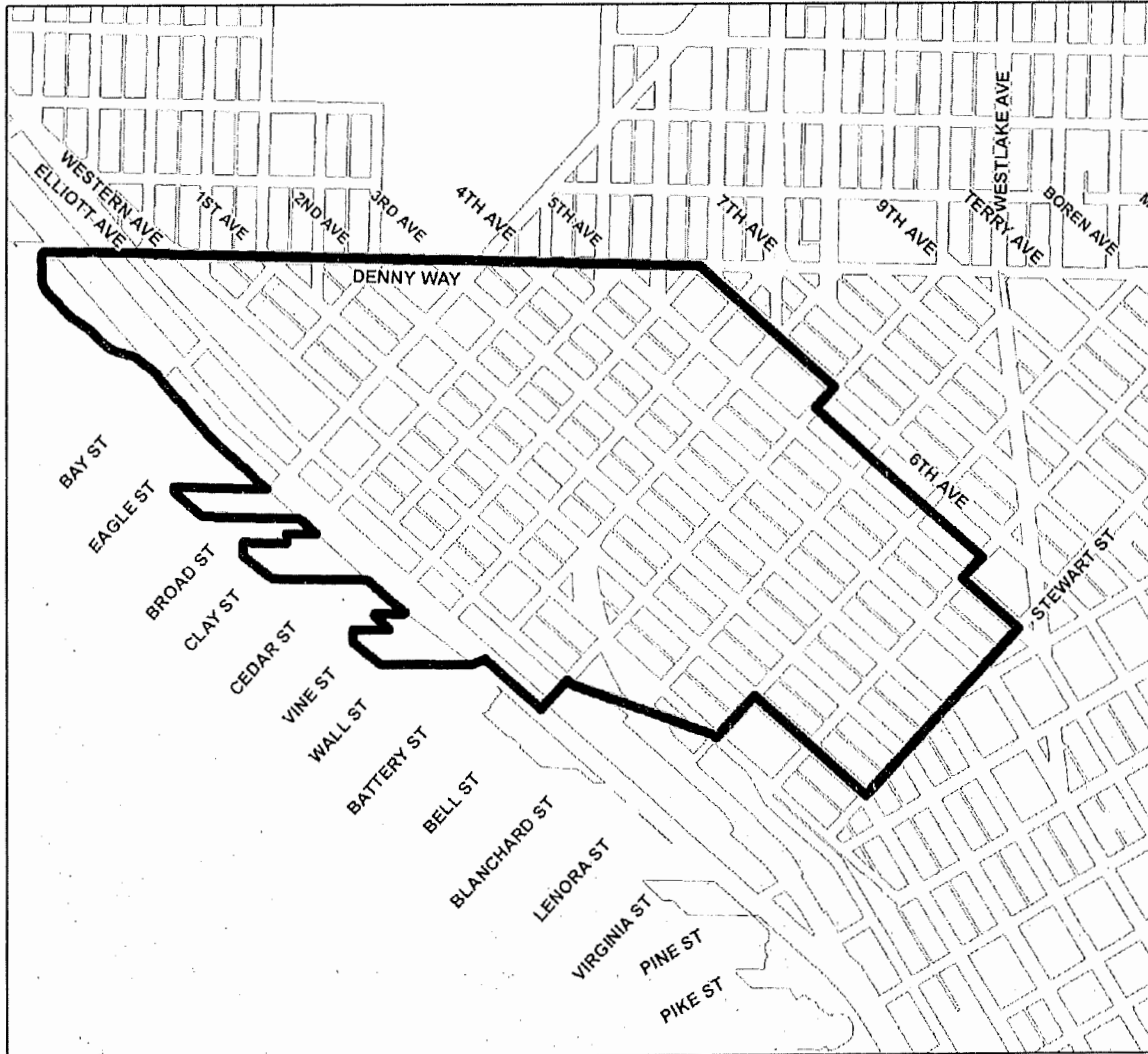

— Belltown Boundary

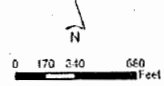

No warranties of any sort, including accuracy, fitness, or merchantability accompany this product.
Copyright 2012, All Rights Reserved, City of Seattle

1 4. Except as otherwise provided in this subsection 23.49.058.F, in the DMC zone
2 with a mapped height limit of more than 160 feet located in the Denny Triangle ((~~Urban Center~~
3 ~~Village~~)), as shown on Map A for 23.49.056, if any part of a tower exceeds 160 feet in height,
4 then all portions of the tower that are above 125 feet in height must be separated from any other
5 existing tower that is above 160 feet in height, and the minimum separation required between
6 towers from all points above the height of 125 feet in each tower is 60 feet.

7 5. The projection of unenclosed decks and balconies, and architectural features
8 such as cornices, shall be disregarded in calculating tower separation.

9 6. If the presence of an existing tower would preclude the addition of another
10 tower proposed on the same block, as a special exception, the Director may waive or modify the
11 tower spacing requirements of this Section 23.49.058 to allow a maximum of two towers to be
12 located on the same block that are not separated by at least the minimum spacing required in
13 subsections 23.49.058.F.2, 23.49.058.F.3, and 23.49.058.F.4, other than towers described in
14 subsection 23.49.058.F.1. The Director shall determine that issues raised in the design review
15 process related to the presence of the additional tower have been adequately addressed before
16 granting any exceptions to tower spacing standards. The Director shall consider the following
17 factors in determining whether such an exception shall be granted:

18 a. ((~~potential~~)) Potential impact of the additional tower on adjacent
19 residential structures, located within the same block and on adjacent blocks, in terms of views,
20 privacy, and shadows;

21 b. ((~~potential~~)) Potential public benefits that offset the impact of the
22 reduction in required separation between towers, including the provision of public open space,
23 designated green street or other streetscape improvements, preservation of landmark structures,

1 and provision of neighborhood commercial services, such as a grocery store, or community
2 services, such as a community center or school;

3 c. ~~((potential))~~ Potential impact on the public environment, including
4 shadow and view impacts on nearby streets and public open spaces;

5 d. ~~((design))~~ Design characteristics of the additional tower in terms of
6 overall bulk and massing, facade treatments and transparency, visual interest, and other features
7 that may offset impacts related to the reduction in required separation between towers;

8 e. ~~((the))~~ The City's goal of encouraging residential development
9 downtown; and

10 f. ~~((the))~~ The feasibility of developing the site without an exception from
11 the tower spacing requirement.

12 7. For purposes of this Section 23.49.058, an "existing" tower is either:

13 a. a tower that is physically present, except as provided below in this
14 subsection 23.49.058.F.7~~((5))~~; or

15 b. a proposed tower for which a Master Use Permit decision that includes
16 approval of the Design Review element has been issued, unless and until either

17 ~~((#))~~ 1) the Master Use Permit issued pursuant to such decision
18 expires or is cancelled, or the related application is withdrawn by the applicant, without the
19 tower having been constructed; or

20 ~~((#))~~ 2) a ruling by a hearing examiner or court of competent
21 jurisdiction reversing or vacating such decision, or determining such decision or the Master Use
22 Permit issued thereunder to be invalid, becomes final and no longer subject to judicial review.

1 A tower that is physically present shall not be considered "existing" if the owner
2 of the lot where such tower is located shall have applied to the Director for a permit to demolish
3 such tower and such application shall be pending or a permit issued for such demolition shall be
4 in effect, but any permit decision or permit for any structure that would not be permitted under
5 this subsection 23.49.058.F.7 if such tower were considered "existing" may be conditioned upon
6 the actual demolition of such tower.

7 * * *

8 Section 8. Section 23.51A.004 of the Seattle Municipal Code, last amended by Ordinance
9 124610, is amended as follows:

10 **23.51A.004 Public facilities in multifamily zones**

11 A. Except as otherwise provided in subsection 23.51A.004.D, uses in public facilities that
12 are most similar to uses permitted outright or permitted as an administrative conditional use
13 under the applicable zoning are also permitted outright or as an administrative conditional use,
14 subject to the same use regulations, development standards, and administrative conditional use
15 criteria that govern the similar use.

16 B. The following uses in public facilities are permitted outright in all multifamily zones if
17 the development standards for institutions in Section 23.45.570, other than dispersion
18 requirements, are met, except as otherwise provided in subsection 23.51A.004.B.6:

- 19 1. Police precinct stations;
- 20 2. Fire stations;
- 21 3. Public boat moorages;
- 22 4. Utility service uses;
- 23 5. Other uses similar to any of the uses listed in this subsection 23.51A.004.B; and

1 6. Youth service centers existing as of January 1, 2013, in public facilities
2 operated by King County in an LR3 zone within an Urban Center ((Village)) and replacement,
3 additions or expansions to such King County public facilities. For youth service centers, the
4 development standards for institutions in Section 23.45.570 apply, and subsections 23.45.570.D
5 and 23.45.570.F relating to structure width and setbacks may be waived or modified by the
6 Director as a Type II decision. The Director's decision to waive or modify standards shall be
7 based on a finding that the waiver or modification is needed to accommodate unique
8 programming, public service delivery, or structural needs of the facility and that the following
9 urban design objectives are met. The Director's decision shall include conditions to mitigate all
10 substantial impacts caused by such a waiver or modification.

11 a. Objective 1: Create visual interest along and activate each street
12 frontage. Examples for achieving this objective include, but are not limited to, the following:

13 1) Incorporate prominent entrances and other features that
14 welcome pedestrians;

15 2) Add visual interest using architectural detailing of the facade,
16 transparency, decorative materials, or design features; and

17 3) Use signage consistent with the Sign Code, Chapter 23.55, that
18 helps orient pedestrians and adds interest to the street environment.

19 b. Objective 2: Create a continuous pedestrian environment along each
20 frontage of the development in LR3. Examples for achieving this objective include, but are not
21 limited to, the following:

22 1) Incorporate shade and rain protection, such as awnings, building
23 overhangs, benches, freestanding pavilions, or kiosks;

1 2) Where site dimensions and program conditions allow, provide a
2 landscaped setback between the structure and sidewalk; and

3 3) Design new or existing bus stops to integrate transit shelters,
4 benches, and decorative treatments with the adjacent facade.

5 c. Objective 3: Address the bulk and scale of the building by design
6 treatments that transition to the scale of nearby development. Examples for achieving this
7 objective include, but are not limited to, the following:

8 1) Break down the apparent scale of the building and reduce the
9 impact of blank walls by using modulation or decorative facade elements, such as material,
10 shape, color, architectural detailing, painting, screening, artwork, or vegetated walls; and

11 2) Use landscaped setbacks where appropriate.

12 C. Unless specifically prohibited in subsection 23.51A.004.D, uses in new public
13 facilities not specifically listed in subsection 23.51A.004.B or permitted pursuant to subsection
14 23.51A.004.A, or that are listed in or permitted pursuant to subsections 23.51A.004.A or
15 23.51A.004.B but do not meet applicable development standards or administrative conditional
16 use criteria, may be permitted by the City Council according to the provisions of Chapter 23.76,
17 with public projects considered as Type IV quasi-judicial decisions and City facilities considered
18 as Type V legislative decisions. In making the decision, the Council may waive or grant
19 departures from development standards or administrative conditional use criteria for public
20 facilities, if the following criteria are satisfied:

21 1. The location of the public facility addresses public service needs, and any
22 waiver or departure from development standards or administrative conditional use criteria is
23 necessitated by those public service delivery needs; and

1 2. The impact of the public facility on surrounding properties has been addressed
2 in the design, siting, landscaping, and screening of the facility.

3 D. The following public facilities are prohibited in all multifamily zones:

4 1. Jails, except for youth service centers existing as of January 1, 2013, in public
5 facilities operated by King County within an Urban Center ((~~Village~~));

6 2. Work-release centers;

7 3. Bus bases;

8 4. Park and ride lots;

9 5. Sewage treatment plants;

10 6. Animal control shelters; and

11 7. Post office distribution centers.

12 E. Expansion of uses in public facilities

13 1. Major expansion. Major expansion of public facilities that are permitted by
14 subsection 23.51A.004.C may be approved by the City Council, with public projects considered
15 as Type IV quasi-judicial decisions and City facilities considered as Type V land use decisions,
16 subject to the criteria of subsections 23.51A.004.C.1 and 23.51A.004.C.2. A major expansion of
17 a public facility occurs if an expansion would not meet development standards or, except for
18 expansion of the Washington State Convention and Trade Center, the area of the expansion
19 would exceed either 750 square feet or 10 percent of the existing area of the use, whichever is
20 greater. A major expansion of the Washington State Convention and Trade Center is one that is
21 12,000 square feet or more in size. For the purposes of this subsection 23.51A.004.E.1, "area of
22 the use" includes gross floor area and outdoor area devoted actively to that use, excluding
23 parking.

1 2. Minor expansion. An expansion of a public facility that is not a major
2 expansion is a minor expansion. Minor expansions to uses in public facilities that are permitted
3 by subsections 23.51A.004.A, 23.51A.004.B, or 23.51A.004.C are permitted outright.

4 F. Essential public facilities will be reviewed according to the provisions of Chapter
5 23.80, Essential Public Facilities.

6 G. Uses in existing or former public schools

7 1. Child-care centers, preschools, public or private schools, educational and
8 vocational training for the disabled, adult evening education classes, nonprofit libraries,
9 community centers, community programs for the elderly, and similar uses are permitted in
10 existing or former public schools.

11 2. Other non-school uses are permitted in existing or former public schools
12 pursuant to procedures established in Chapter 23.78, Establishment of Criteria for Joint Use or
13 Reuse of Schools.

14 Section 9. Subsection 23.58A.040.A of the Seattle Municipal Code, which section was
15 last amended by Ordinance 124513, is amended as follows:

16 **23.58A.040 Bonus floor area for open space amenities**

17 A. Findings. The City Council finds that:

18 1. Amenities, including public open space, are an important aspect of livability in
19 areas targeted in the Comprehensive Plan for concentrated housing and employment growth.

20 ~~((To address this need, the Comprehensive Plan establishes goals for the amount and distribution~~
21 ~~of open space. These goals are consistent with national standards developed to assist~~
22 ~~communities with planning to provide adequate open space serving specified population needs.))~~

1 2. Developments that add density will increase demand for public open space. If
2 additional public open space is voluntarily provided to offset additional demand, the impacts on
3 available open space resources will be mitigated.

4 3. Within Highrise zones, the average amount of public open space, including
5 breathing room open space, needed to accommodate residential development is at least 0.14
6 square feet of open space per gross square foot of residential floor area in a development.

7 * * *

8 Section 10. Subsection 23.69.030.E of the Seattle Municipal Code, which section was last
9 amended by Ordinance 123649, is amended as follows:

10 **23.69.030 Contents of a master plan**

11 * * *

12 E. The development program component shall include the following:

13 1. A description of alternative proposals for physical development including an
14 explanation of the reasons for considering each alternative, but only if an Environmental Impact
15 Statement is not prepared for the master plan; and

16 2. Density as defined by total maximum developable gross floor area for the MIO
17 District and an overall floor area ratio (FAR) for the MIO District. Limits on total gross floor
18 area and ~~((floor area ratios))~~ FARs may also be required for sub-areas within the MIO District
19 but only when an MIO District is over 400 acres in size or when an MIO District has distinct
20 geographical areas; and

21 3. The maximum number of parking spaces allowed for the MIO District; and

22 4. A description of existing and planned future physical development on a site
23 plan that shall contain:

1 a. The height, description, gross floor area, and location of existing and
2 planned physical development, and

3 b. The location of existing open space landscaping and screening, and
4 areas of the MIO District to be designated open space. Designated open space shall be open
5 space within the MIO District that is significant and serves as a focal point for users of the Major
6 Institution. Changes to the size or location of designated open space requires an amendment
7 pursuant to Section 23.69.035, and

8 c. Existing public and private street layout, and

9 d. Existing and planned parking areas and structures; and

10 5. A site plan showing: property lines and ownership of all properties within the
11 applicable MIO District, or areas proposed to be included in an expanded MIO District, and all
12 structures and properties a Major Institution is leasing or using or owns within 2,500 feet of the
13 MIO District; and

14 6. Three-dimensional drawings to illustrate the height, bulk, and form of existing
15 and planned physical development. Information on architectural detailing such as window
16 placement and color and finish materials is not required; and

17 7. A site plan showing any planned infrastructure improvements and the timing of
18 those improvements; and

19 8. A description of planned development phases and plans, including development
20 priorities, the probable sequence for such planned development and estimated dates of
21 construction and occupancy; and

22 9. A description of any planned street or alley vacations or the abandonment of
23 existing rights-of-way; and

1 10. At the option of the Major Institution, a description of potential uses,
2 development, parking areas and structures, infrastructure improvements or street or alley
3 vacations. Information about potential projects is for the purpose of starting a dialogue with the
4 City and the community about potential development, and changes to this information will not
5 require an amendment to the master plan; and

6 11. An analysis of the proposed master plan's consistency with the purpose and
7 intent of this ((~~chapter~~)) Chapter 23.69 as described in Section 23.69.002; and

8 12. A discussion of the Major Institution's facility decentralization plans and/or
9 options, including leasing space or otherwise locating uses off-campus; and

10 13. A description of the following shall be provided for informational purposes
11 only. The Advisory Committee, pursuant to Section 23.69.032.D.1, may comment on the
12 following but may not subject these elements to negotiation nor shall such review delay
13 consideration of the master plan or the final recommendation to Council:

14 a. A description of the ways in which the institution will address goals and
15 applicable policies under ((~~Education and Employability and Health~~)) Healthy Growth, Aging,
16 and Lifestyles and Lifelong Learning headings in the ((~~Human Development~~)) Community Well-

17 Being Element of the Comprehensive Plan, and

18 b. A statement explaining the purpose of the development proposed in the
19 master plan, including the public benefits resulting from the proposed new development and the
20 way in which the proposed development will serve the public purpose mission of the Major
21 Institution.

22 * * *

1 Section 11. Section 23.75.002 of the Seattle Municipal Code, enacted by Ordinance
2 123963, is amended as follows:

3 **23.75.002 Purpose and intent**

4 The Comprehensive Plan Land Use Element (~~(Section C)~~) establishes a Master Planned
5 Community designation (MPC). The purpose of this Chapter 23.75 and the (~~Master Planned~~
6 ~~Community~~) MPC zone is to implement the Comprehensive Plan by regulating land use within
7 MPC zones. By allowing greater flexibility in the application of zoning and development
8 requirements, an MPC zone designation is intended to support highly coordinated infill
9 development with a higher level of environmental sustainability, affordable housing, and
10 publicly accessible open space than is typically provided through conventional lot-by-lot
11 development.

12 Section 12. Section 23.84A.040 of the Seattle Municipal Code, last amended by
13 Ordinance 124919, is amended by deleting the following definition:

14 **23.84A.040 “U”**

15 * * *

16 (~~“Urban center village” means a portion of a larger urban center designated in Seattle’s~~
17 ~~Comprehensive Plan as an urban center village.~~)

18 * * *

19 Section 13. Subsection 5.72.020.L of the Seattle Municipal Code, which section was last
20 amended by Ordinance 121700, is amended as follows:

21 **5.72.020 Definitions.**

22 L. “Urban village” as used in this (~~chapter~~) Chapter 5.72 means a neighborhood that:
23 (1) is within an area designated as either (~~an urban center village,~~) a hub urban village or a

1 residential urban village in the City's Comprehensive Plan; and (2) meets the definition of an
2 "urban center" as defined in RCW ((Section)) 84.14.010.

3

1 Section 14. This ordinance shall take effect and be in force 30 days after its approval by
2 the Mayor, but if not approved and returned by the Mayor within ten days after presentation, it
3 shall take effect as provided by Seattle Municipal Code Section 1.04.020.

4 Passed by the City Council the 17th day of October, 2016,
5 and signed by me in open session in authentication of its passage this 17th day of
6 October, 2016.

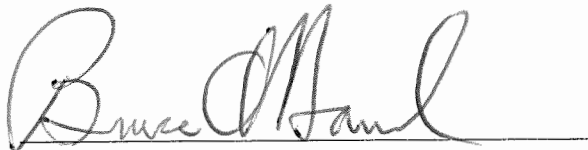
7 

8 President _____ of the City Council

9 Approved by me this 28th day of October, 2016.

10 

11 Edward B. Murray, Mayor

12 Filed by me this 28th day of OCTOBER, 2016.

13 

14 Monica Martinez Simmons, City Clerk

15 (Seal)
16
17
18

- 1 Attachments:
- 2
- 3 Attachment 1 – Seattle 2035 Seattle Comprehensive Plan
- 4 Seattle City Council Amendments to Seattle 2035 Seattle Comprehensive Plan:
- 5 Attachment 2 – Title and Introduction Amendments
- 6 Attachment 3 – New Community Involvement Element
- 7 Attachment 4 – Growth Strategy Element Amendments
- 8 Attachment 5 – Land Use Element Amendments
- 9 Attachment 6 – Transportation Element Amendments
- 10 Attachment 7 – Housing Element Amendments
- 11 Attachment 8 – Capital Facilities Element Amendments
- 12 Attachment 9 – Utilities Element Amendments
- 13 Attachment 10 – Economic Development Element Amendments
- 14 Attachment 11 – Environment Element Amendments
- 15 Attachment 12 – Parks and Open Space Element Amendments
- 16 Attachment 13 – Arts and Culture Element Amendments
- 17 Attachment 14 – Community Well-Being Element Amendments
- 18 Attachment 15 – Glossary Amendments
- 19 Attachment 16 – Amendments to Neighborhood Plans
- 20 Attachment 17 – Amendments to the Appendices



Seattle 2035

Comprehensive Plan

Managing Growth
to Become an Equitable City

2015-2035

Mayor's Recommended Plan May 2014





City of Seattle

Edward B. Murray, Mayor

Friends,

I am pleased to present my recommendations for the *Seattle 2035 Comprehensive Plan*. This document is a blueprint for equitable growth over the next 20 years.

For the last 20 years Seattle has been recognized as a leading green and sustainable city. We showed how a large city can grow and still conserve water and electricity, reduce waste, and erect some of the greenest buildings in the world. But, over the next 20 years we must address an even bigger challenge—the growing inequality in our city.

Building an equitable and sustainable city is more than managing growth, offering more transportation options, and reducing our environmental impact. It means reducing poverty and creating an enduring economy, increasing access to education, and fostering livable, affordable and inclusive neighborhoods. This is my vision for Seattle.

Achieving this vision requires a great long term plan. One shaped by the thousands of individuals and organizations who were engaged in the *Seattle 2035* process over the last two years. All of the comments and feedback helped make this a stronger and better plan.

Together we can ensure Seattle continues to be a safe, vibrant, affordable, interconnected and innovative city for all.

Sincerely,

A handwritten signature in black ink, appearing to read "Edward B. Murray". The signature is fluid and cursive, with a long, sweeping underline.

Edward B. Murray
Mayor, City of Seattle



Acknowledgments

Mayor Edward Murray

Office of Planning and Community Development

Diane Sugimura, Interim Director, Office of Planning and Community Development

Drew Badgett

Diana Canzoneri

Stacy Cannon

Patrice Carroll

Ian Dapiaoen

Tom Hauger

Laura Hewitt Walker

Quanlin Hu

Aaron Hursey

Kristian Kofoed

Nora Liu

Jeanette Martin

Susan McLain

Jennifer Pettyjohn

Katie Sheehy

Brennon Staley

Valauri Stotler

Janet Shull

Nick Welch

Seattle Department of Construction and Inspection

Moon Callison

Gordon Clowers

Maggie Glowacki

Nathan Torgelson

Mayor's Office

Sara Belz

Robert Feldstein

Chris Gregorich

Seattle 2035 Interdepartmental Team

Emily Alvarado, OH

Roberta Baker, SDCI

Daniel Bretzke, FAS

Maura Brueger, SCL

James Bush, DON

Kathleen Connor, SPR

Randy Cox, FAS

Roque Deherrera, OED

Diana Falchuk, OCR

Lish Whitson, LEG

Darlene Flynn, OCR

David Graves, SPR

Terry Hayes, HSD

Michael James, SDOT

Mark Jaeger, SPU

Susan Mc Callister, HSD

Eric McConaghy, LEG

Chisaki Muraki-Valdovinos, SDOT

Tony Mazzella, SDOT

Kevin O'Neill, SDOT

Tracy Morgenstern, OSE

Chip Nevins, SPR

Valerie Pacino, OSE

Matthew Richter, OAC

Susanne Rockwell, SPR

Amy Shumann, KC Public Health

Josh Walter, SCL

Julie West, KC Public Health

Equitable Development Initiative Interdepartmental Team

Emily Alvarado, OH	Susan Golub, SPR	Nora Liu, OPCD
Jessica Brand, DON	Heidi Hall, OED	Sudha Nandagopal, OSE
Senait Brown, DON	Steve Hamai, SPU	Matthew Richter, OAC
James Bush, DON	Michael James, SDOT	Joaquin Uy, OIRA
Diana Canzoneri, OPCD	David Keyes, SIT	Nick Welch, OPCD
Michael Davis, SPU	Bill LaBorde, SDOT	

City of Seattle Race and Social Justice Initiative Change Teams

Seattle Planning Commission

Grace Kim, Chair	Yolanda Ho	Spencer Williams
Kara Martin, Vice-Chair	Amalia Leighton	Patti Wilma
Michael Austin	Jake McKinstry	Vanessa Murdock, Executive Director
Lauren Craig	Tim Parham	John Hoey, Senior Policy Analyst
Molly Esteve	Marj Press	Robin Magonegil, Administrative Asst
Sandra Fried	David Shelton	

Consultants

3 Square Blocks	SvR	Girl Friday Productions
BERK	Weinman Consulting	John Skelton Photography
ESA	EnviroIssues	PolicyLink
Fehr & Peers	KillerInfographics	

In-Kind Services

Consider.it Designed and hosted an online community conversation for the Draft Plan
Youth in Focus Student photos featured in our report
Tim Durkan Photography Cover photo

Very Special Thanks

To all the individuals and organizations who gave time and thought to participate in the Seattle 2035 process in person and online. The plan is better and stronger because of your involvement.

DON	Department of Neighborhoods	SCL	Seattle City Light
FAS	Finance and Administrative Services	SDCI	Seattle Department of Construction and Inspection
KC	King County	SDOT	Seattle Department of Transportation
LEG	City Council Central Legislative Staff	SIT	Seattle IT
OAC	Office of Arts and Culture	SPR	Seattle Parks and Recreation
OED	Office of Economic Development	SPU	Seattle Public Utilities
OH	Office of Housing		
OIRA	Office of Immigrant and Refugee Affairs		
OPCD	Office of Planning and Community Development		
OSE	Office of Sustainability and Environment		

1

Citywide Planning

Introduction	3
Growth Strategy	20
Land Use (and Future Land Use Map)	31
Transportation	69
Housing	93
Capital Facilities	103
Utilities	111
Economic Development	119
Environment	126
Parks and Open Space	131
Arts and Culture	140
Community Well-Being	147
Neighborhood Planning	150
Container Port	163
Shoreline Areas	164
Glossary	174

2

Neighborhood Plans

Admiral
Aurora-Licton
Ballard/Interbay Northend Manufacturing/Industrial Center
Broadview/Bitter Lake/ Haller Lake
Capitol Hill
Central Area
Columbia City
Crown Hill/Ballard
Delridge
Downtown
Eastlake
First Hill
Fremont
Georgetown
Greater Duwamish Manufacturing/Industrial Center
Green Lake
Greenwood/Phinney Ridge
Morgan Junction
North Beacon Hill
North Neighborhoods (Lake City)
North Rainier
Northgate
Othello
Pike/Pine
Queen Anne (Uptown)
Rainier Beach
Roosevelt
South Lake Union
South Park
University Community
Wallingford
West Seattle Junction
Westwood/Highland Park

3

Appendices

Growth Strategy	401
Land Use	406
Transportation	430
Housing	479
Capital Facilities	508
Utilities	514
Legislative History of the Comprehensive Plan	577



Citywide Planning

Introduction



Seattle is a growing city. We use this Comprehensive Plan to manage growth in a way that benefits all of the city's residents and preserves the surrounding natural environment.

Seattle's recent building boom is a reminder of how desirable Seattle is as a place to live and work. Since the Plan was first adopted in 1994, the City has worked to accommodate new people and businesses, while at the same time looking for ways the city can continue to be livable for future generations. Further growth will present challenges and opportunities similar to the ones we have faced in the recent past. The City has created this Plan as a guide to help it make decisions about managing growth equitably over the next twenty years.

The City in the Region

With the most people and jobs of any city in Washington State, Seattle is the center of the fast-growing Central Puget Sound region. Made up of King, Snohomish, Pierce, and Kitsap Counties, this dynamic metropolitan region expects its population to exceed five million by 2040. Seattle hosts many of the region's largest employers, including the University of Washington and major medical facilities. It also contains cultural attractions such as the Seattle Symphony, the Northwest Folklife Festival, and professional sports teams, and serves as the focal point of the region's multiple transit systems.

Over the past decade, the city has grown rapidly, adding an average of about four thousand housing units and seven thousand people each year. In the years to come, Seattle expects to accommodate a significant share of the region's growth. This Plan contains goals and policies designed to guide growth in a manner that reflects the City's core values and that enhances the quality of life for all.

What Drives This Plan

Seattle's Core Values

Before Seattle's Comprehensive Plan was first drafted in the early 1990s, City staff and the Planning Commission held numerous community meetings, with the intention of inviting more people into the conversation and hearing from groups who hadn't always been at the table. The goal of City staff and the Commission was to identify the values that people cared most about. The principles that emerged from these conversations came to be known as the core values for the Comprehensive Plan, and they are still valid. This version of the Plan honors the efforts of those past participants and holds the same values at its center.

Race and Social Equity. Seattle believes that every resident should have the opportunity to thrive and to be a part of the city's growing economy. In 2015 the mayor and the City Council adopted a resolution that changed the title of this value from "social equity" to "race and social equity," to emphasize the need to address disparities experienced by people of color.

Historically in the city of Seattle and throughout the nation, people have been denied equal access to education, jobs, homes, and neighborhoods because of their race, class, disabilities, or other real or perceived differences. While such practices are now illegal, some groups still do not enjoy access to the same job opportunities, security, and freedoms that other Seattle residents have. The benefits and burdens of growth are not distributed equitably.

Seattle has not yet achieved social equity for all who live and work in our city, and statistics have shown that this is particularly true for people of color.

These inequities have become more significant as the makeup of Seattle's population has changed. The city has gone from being 25 percent people of color in 1990 to 34 percent in 2010, and this trend is expected to continue. More immigrants will arrive, and minority populations will continue to grow through natural increase. The map on the following page shows locations in the city where there are concentrations of people of color.



L Photo © John Skelton **R** Photo © Youth in Focus students

With more people moving into the city, property values could increase or existing buildings and homes could be replaced with new and more expensive ones. Changes like these will affect some communities more than others and could make it more difficult for residents or businesses to remain in their current neighborhoods, especially in low-income areas. In some cases these outcomes are unavoidable, but the City must try to help existing residents and businesses remain part of our growing and changing community.

Since the early 2000s, the City has worked to implement a race and social justice initiative, a citywide effort to make racial equity a reality. This version of the Comprehensive Plan marks a renewed and strengthened commitment to that goal.

The main goal of the Comprehensive Plan is to guide the physical development of the city. However, in shaping how we create new spaces for people to live, work, and play, this Plan

2010 Population

by major racial category and Hispanic/Latino ethnicity

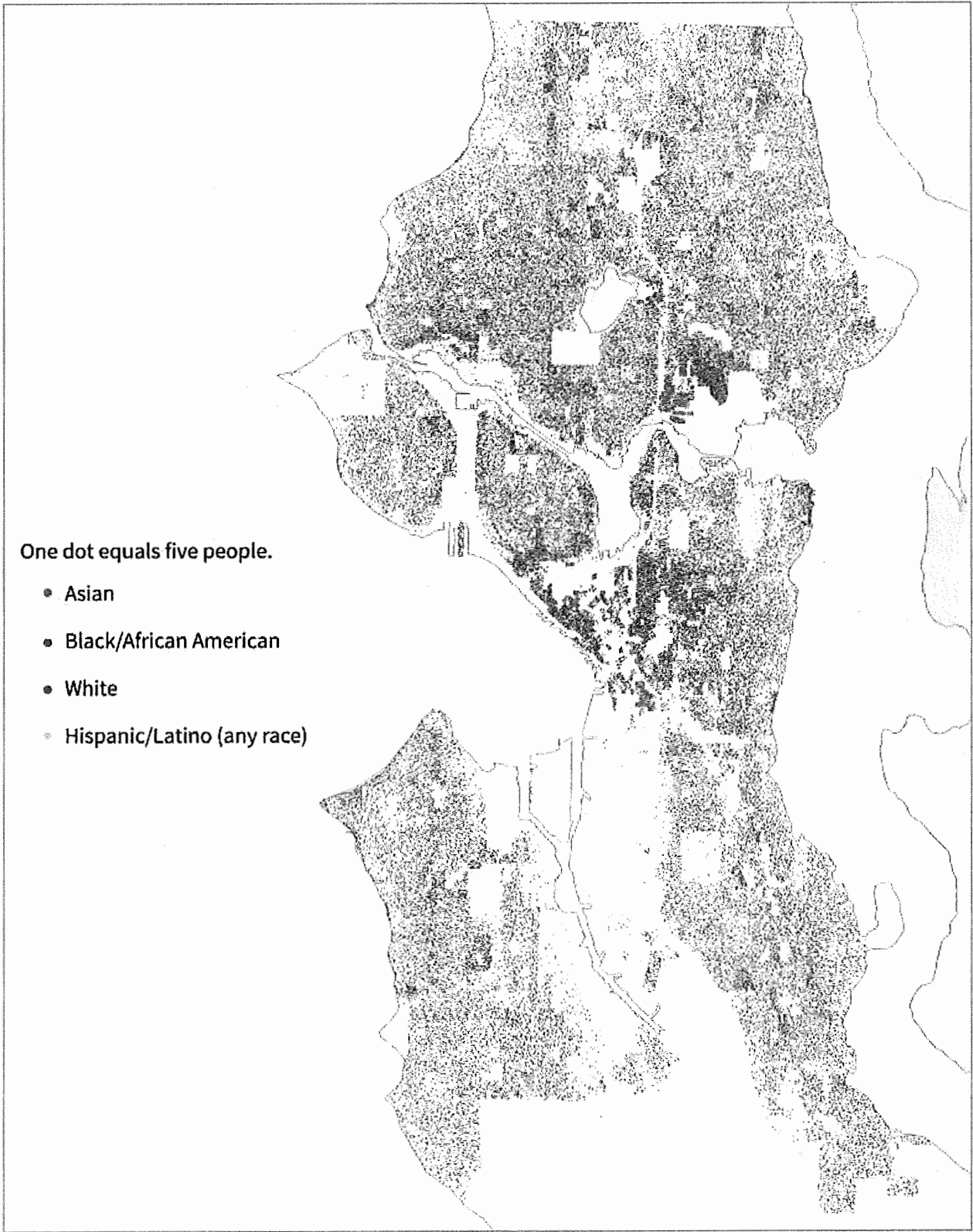

also aims to give all Seattle residents better access to jobs, education, affordable housing, parks, community centers, and healthy food. The goals and policies in this Plan can also influence the actions of other government agencies and private businesses to promote social justice and racial equity. Working toward equity will help produce stronger and more resilient economic growth—growth that benefits everyone.

Seattle is a city where much of the population enjoys comfortable to very high incomes, yet roughly one out of seven Seattleites has an income below the poverty line. In Seattle, the poverty rate for people of color is more than two and a half times that for whites. High rates of poverty among single-parent families, disabled people, and other demographic groups reveal additional disparities in the well-being of Seattle residents.

Poverty in Seattle

Percentage with incomes below poverty level

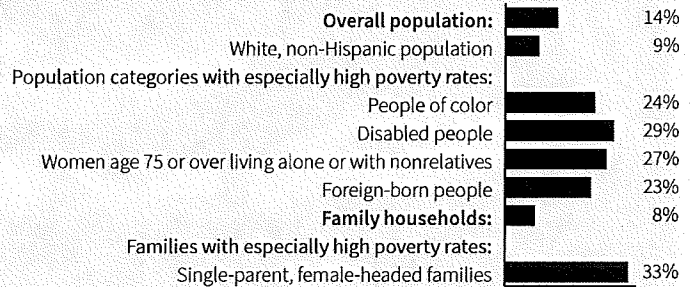

Source: 2011–2013 ACS, US Census Bureau.

Notes: Some people (for example, people living in college dormitories and people who are institutionalized) are not included in poverty rate calculations.

The discussions that introduce sections of this Plan highlight other facts about some conditions or services as they relate to the income or racial characteristics of people in Seattle.

Economic Opportunity and Security. Seattle recovered from the great recession and grew beyond 2008's high employment levels, and by 2014 the city contained 514,700 jobs. Boeing and Amazon have been major contributors to that employment growth, but other, smaller businesses have also provided new jobs.

For businesses to thrive, they need skilled employees and space to grow. For specific examples of how this Plan addresses economic opportunity, look in the Growth Strategy and Land Use elements. These elements include policies that identify locations for employment growth and give ideas for how to direct growth there. The Economic Development element encourages businesses to put down roots and expand, while the Community Well-Being element talks about helping people get the kind of education and skills they will need to fill the newly created jobs.

Sometimes, just having a job isn't enough. Even when employed, many people may not be able to afford to live in the city. Through this Plan, the City demonstrates its commitment to promoting livable wages and giving people equal opportunities. The City has also developed programs to help address continuing racial disparities in education and employment.



Photo © John Skelton

Environmental Stewardship. Even as the city becomes increasingly urban, Seattle is dedicated to protecting and restoring the green spaces and water that make our city special. Between the time the Plan was first adopted and 2014, Seattle has accommodated more than its expected share of countywide residential growth—adding more than sixty-seven thousand new housing units, compared to the original Plan’s estimate of fifty thousand to sixty thousand. This has helped reduce the proportion of countywide housing growth in rural areas from about 15 percent in the 1980s to less than 2 percent in recent years. By taking on a significant share of the region’s growth, Seattle has helped protect rural farms and forests from development. And by concentrating growth in urban villages, we help preserve the existing green areas in the city, including the areas that now contain low-density development.

The City has committed to make Seattle carbon neutral by the year 2050 in order to reduce the threat of climate change. To reach this ambitious and important goal, local government, businesses, and residents will need to work together. This Plan contains goals and policies to help guide this effort. For instance, the **Growth Strategy** and **Transportation** elements promote development that will make walking, biking, and public transit viable options for more people so that they can be less reliant on automobiles—a major source of carbon emissions in this region.

Community. Seattle is made up of many small communities, where people bond because of shared interests or backgrounds. Each of the small communities is a crucial part of the whole, and all the communities working together is what makes the larger Seattle community thrive.

To prepare this Plan and previous versions of it, hundreds of people participated in meetings, filled out comment forms, and wrote e-mails and letters to the City. Among the diverse groups of people who call Seattle home, there were many different—and often competing—interests and perspectives. Yet there was one goal in common: to make Seattle the best city for living, working, and raising families. This Plan encourages continued broad public participation in decisions that affect all aspects of the city.

Sustainability

The Plan has been guided by the principle of sustainability. One definition of *sustainable development* is “development that meets the needs of the present without compromising the ability of future generations to meet their own needs.” This Plan presents ways to sustain the natural environment by directing more urban growth into Seattle in order to preserve forests and farmlands outside the city. The concept of sustainability also applies to the urban environment, where the City uses its funds efficiently by limiting the number of places where it encourages significant growth. This principle is still an important guide to how the Plan is written and how it will be implemented.

Washington’s Growth Management Act

The state Growth Management Act (GMA), enacted in 1990, requires counties and larger cities to create comprehensive plans and update those plans regularly. The GMA’s goals include reducing sprawl and directing growth to areas that already have water, sewer, transportation, and other urban services. The GMA calls on each county to draw what is called an urban-growth boundary. Urban-style development is not allowed outside that boundary. Comprehensive plans must show that each city has enough land with the right zoning to absorb the growth that is expected to occur over the next twenty years. Cities must also plan for the housing, transportation, water, sewer, and other facilities that will be needed. The GMA requires that plans be consistent with other plans in the region. In this region, other plans include Vision 2040 and the King County Countywide Planning Policies.

Vision 2040

The Puget Sound Regional Council (PSRC) is the regional growth management, transportation, and economic development organization covering King, Snohomish, Pierce, and Kitsap Counties. It is governed by elected officials from across the region. Together these officials have created a regional growth strategy called **Vision 2040**, which recommends that new jobs and residents should be directed to designated centers connected with high-capacity

transit. Seattle's Plan identifies six regional growth centers and two manufacturing/industrial centers that are recognized in the regional plan. Consistent with the regional growth strategy, the Plan contains housing- and job-growth targets for each of those centers. Vision 2040 also assumes a distribution of growth across the Puget Sound region, with especially large shares of growth going to the five metropolitan cities—Seattle, Bellevue, Everett, Tacoma, and Bremerton. This Plan reflects Seattle's commitment to accommodate its share of growth as the metropolitan city at the heart of the region.

The PSRC often describes Vision 2040 as enhancing people, the planet, and prosperity. This Plan addresses those same aspects of growth through policies that renew the emphasis on race and social equity, draw growth to areas of the city where public facilities exist, set rules for protecting environmentally critical areas, promote nonautomobile travel, attract diverse job growth, focus on education and job training to help people participate in the region's economy, and provide affordable housing through a number of local tools.

The PSRC brought together representatives from local governments and the private sector to develop guidelines for how to plan for areas around light rail stations. The result was the Growing Transit Communities Regional Compact, a regional agreement that proposed ways to make sure that everyone, including lower-income people and communities of color, would benefit from the new transit system and other improvements that occur around it.

King County Countywide Planning Policies

In King County, the Growth Management Planning Council is made up of elected officials representing all the jurisdictions. They have worked together to develop the **Countywide Planning Policies** (CPPs), which provide guidance for the comprehensive plans that the cities in King County must adopt. The CPPs contain twenty-year housing- and job-growth targets for each jurisdiction. Those targets are what this Plan is designed to address. The CPPs also address the need for affordable housing in the county, for local action to address climate change, and for growing in ways that will create healthy communities.

Seattle's Urban Village Strategy

The foundation of Seattle's Comprehensive Plan is the urban village strategy. It is the City's unique approach to meeting the state GMA requirement, and it is similar to Vision 2040's growth centers approach. This strategy encourages most future job and housing growth to occur in specific areas in the city that are best able to absorb and capitalize on that growth. These are also the best places for efficiently providing essential public services and making amenities available to residents. These areas include designated urban centers, such as Downtown and the five others (First Hill/Capitol Hill, South Lake Union, Uptown, University District, and Northgate) recognized in the regional plan. In addition, this Plan designates twenty-four urban villages throughout the city. Both urban centers and urban villages are

places that already have active business districts and concentrations of housing. The urban village strategy

- *accommodates Seattle's expected growth in an orderly and predictable way;*
- *strengthens existing business districts;*
- *promotes the most efficient use of public investments, now and in the future;*
- *encourages more walking, bicycling, and transit use; and*
- *retains the character of less dense residential neighborhoods outside of urban villages.*

By encouraging both business and housing growth in the urban centers and urban villages, the Plan makes it possible for more people to live near job opportunities and near services that can meet their everyday needs. In this way, more people are able to walk or bike to some of their daily activities, leading to more activity on the sidewalks and fewer vehicles on the streets, and making these communities more vibrant. The urban village strategy also puts more people near transit service so that they can more easily use buses or light rail to get to other job centers, shopping, or entertainment. This access is useful for all residents, but particularly those with limited incomes or physical limitations that make them reliant on public transit.

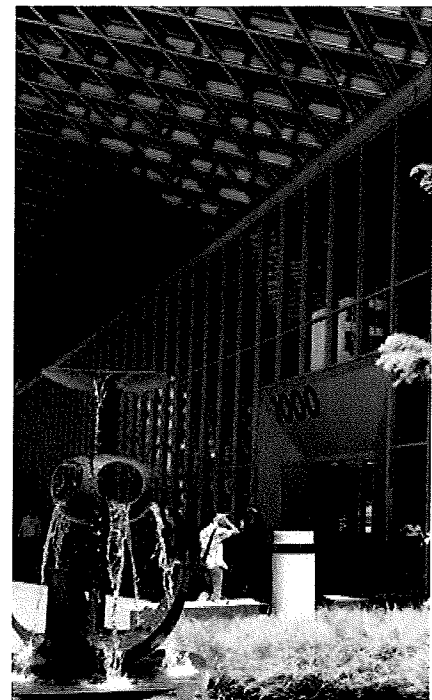

L Photo © Youth in Focus students. R Photo © John Skelton

The urban village strategy puts into practice the regional growth center concept called for in regional plans, but at a more local scale. In addition to the regionally recognized urban centers, the Plan identifies two categories of urban villages, each intended to combine housing



with employment opportunities, shops, and services, all in compact environments that encourage walking. The Plan identifies six hub urban villages where a fair amount of housing and employment growth should occur, though at lower densities than in the centers. It also identifies eighteen residential urban villages scattered around the city where modest housing growth should occur near retailers and services that mainly serve the nearby population.

All of the urban centers and villages identified in the Plan function the way the regional plans anticipate: as compact, pedestrian-friendly areas that offer different mixes of office, commercial, civic, entertainment, and residential uses, but at scales that respect Seattle's character and development pattern.

The urban village strategy has been successful in achieving its purposes over the twenty-some years it has been in place. During that time, over 75 percent of the city's new housing and new jobs were located inside the urban centers and villages that together make up only about 17 percent of the city's total land area. **(See the map on the following page.)** More than half of the housing growth occurred in the six urban centers.

More of the urban villages are thriving now than in 1994, when the strategy was first adopted. Columbia City, Ballard, and Madison/Miller are just a few of the neighborhoods where added residents and new businesses have meant more people out on the sidewalks, enjoying their communities and raising the overall vitality of each area. The villages continue to provide new services and goods for residents in nearby areas, and this means that community members have less distance to travel to get what they need and want. However, the long-sought prosperity in these communities has sometimes come at the cost of changing the character of the neighborhoods and forcing some former residents and businesses to leave. Those who left were often lower-income households, whose housing was replaced by more expensive new buildings or who could not afford the rising rents brought on by the neighborhood changes. In defining the future success of the urban village strategy, the City will try to plan ways for the urban villages to include opportunities for **marginalized populations** to remain in the city and to access education and affordable housing.

In many of the urban villages, ridership on King County Metro buses has outpaced the population growth, and several of these villages have benefited from the light rail service that first opened in 2009, providing another option for traveling without a car.

Of course, urban villages are more than just the fulfillment of the regional growth strategy; they are neighborhoods where Seattle residents live, work, learn, shop, play, and socialize. After initial adoption of the Plan, the City engaged in a citywide neighborhood-planning effort that produced a neighborhood plan for each area of the city containing an urban center or urban village. Those neighborhood plans found some common themes for improvement among the different communities and also highlighted some needs that were unique to each of those neighborhoods. To address the common themes, voters approved funding for libraries, open spaces, community centers, and transit. Since the neighborhood plans were

Housing Units Built 1995-2014

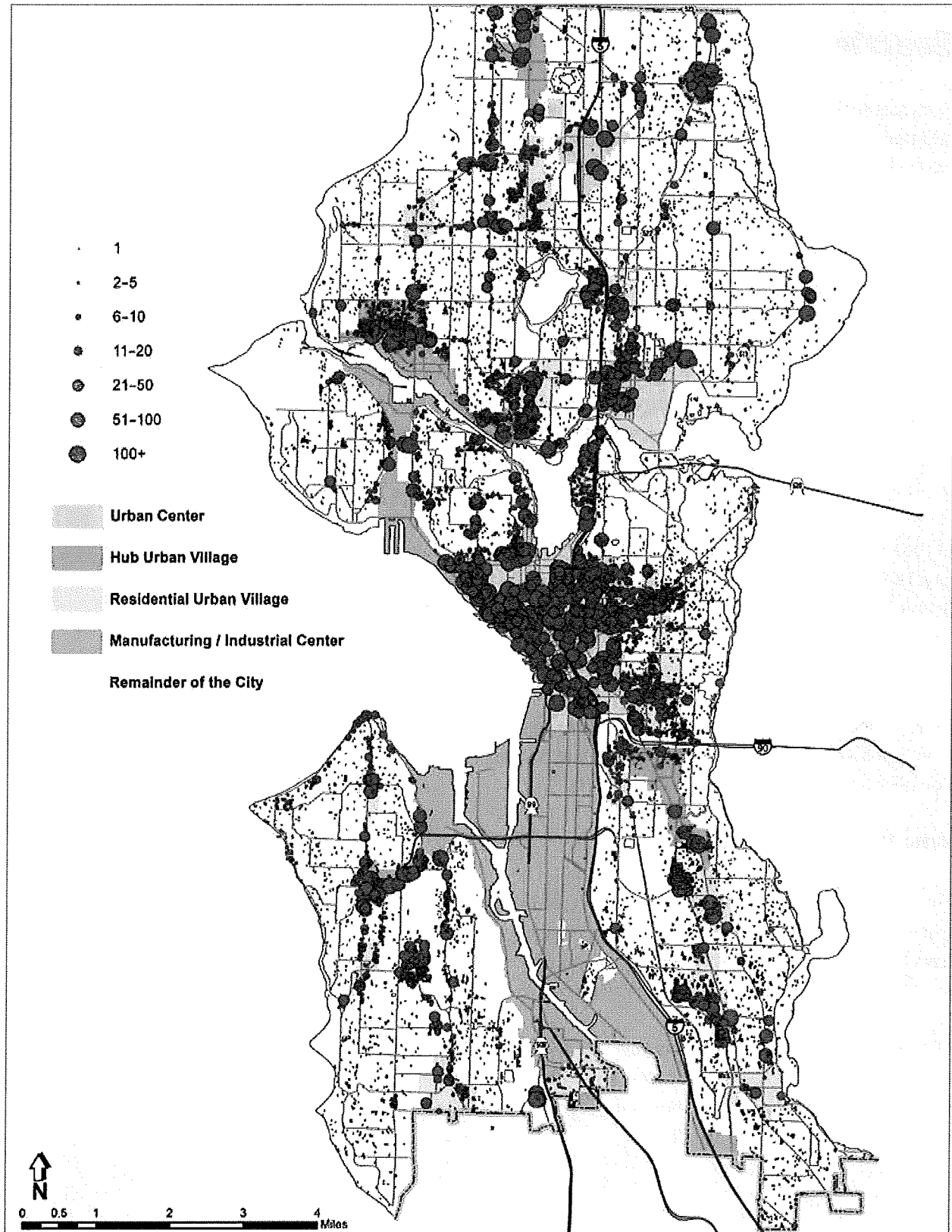

first adopted, the City has worked with communities to refine more than half of those plans and help take action to accomplish the goals that each community prioritized.

Seattle 2035

Forecasts suggest that over the next twenty years, Seattle will need to accommodate 70,000 additional housing units, 120,000 more residents, and 115,000 additional jobs. This updated version of the Plan builds on the success of the urban village strategy to encourage that growth to occur in a manner that works for all of the city's people. Most urban centers and villages have continued to grow rapidly during the recent building boom, and current zoning allows them to handle even more growth. The City expects that between now and 2035, most housing and employment growth will occur in those urban centers and villages.

In addition, light rail service in Seattle now provides certain areas of the city with more frequent and reliable transit connections to a greater number of locations. Light rail already connects the University of Washington, Capitol Hill, Downtown, Southeast Seattle neighborhoods, and the airport. By 2021 it will reach Roosevelt and Northgate, and by 2023, it will stretch to Lynnwood and the Eastside. By 2035, there could be even more light rail lines in the city.

In 2014, voters in Seattle approved a levy that funds additional Metro bus service in the city. This increased transit service represents major investments and commitment to many Seattle neighborhoods, and is an opportunity that Seattle should not waste. To leverage this investment to the fullest extent, the Plan calls for focusing more growth in areas within a ten-minute walk of light rail stations and in locations with very good bus service.

As mentioned above, the City has committed to be carbon neutral by the year 2050. This Plan spans a critical time for the City in meeting that goal, and it provides some of the direction necessary to assist the City in achieving it.

Who We Are Planning For

This Plan is for the people who live in, work in, and visit Seattle today. It is also for those who will make up the community of Seattle in the future—not only our children but also the newcomers who will arrive for education or job opportunities and who will value the urban and natural features of Seattle as much as we do.

While we have an idea of how many new housing units and jobs the City should expect over the next twenty years, it is harder to know more specific information about the ages, incomes, and family structures of those future residents and workers, and to get a real picture of who our new neighbors might be.

The US Census and other sources give us a good description of the city's current population and information about recent trends that help offer a general picture of the future population.

Seattle's population in 2015 was 662,400, and growth over the next twenty years will add about 120,000 people to that total. Seattle's population is younger than the population in the surrounding region, with a higher percentage of twenty-somethings in the city than in King County as a whole. However, Seattle has a much lower percentage of people below the age of eighteen than does the rest of King County. In fact, Seattle's percentage of households containing children is one of the lowest among large cities in the United States. The age differences in Seattle households are even more dramatic in urban centers.

The average number of people living in a household in Seattle (2.06) is also lower than in King County (2.39). Seattle's household size has been decreasing since the 1960s, but the rate of that decrease has slowed in the past twenty years. Household size could continue to decline slowly in the future.

Just as Seattle's current population is younger than that of the surrounding areas, Seattle's older population is growing at a slower rate than that of other parts of King County. Still, in the future, we can expect that there will be more seniors living in the city than there are today, as the baby boom generation ages.

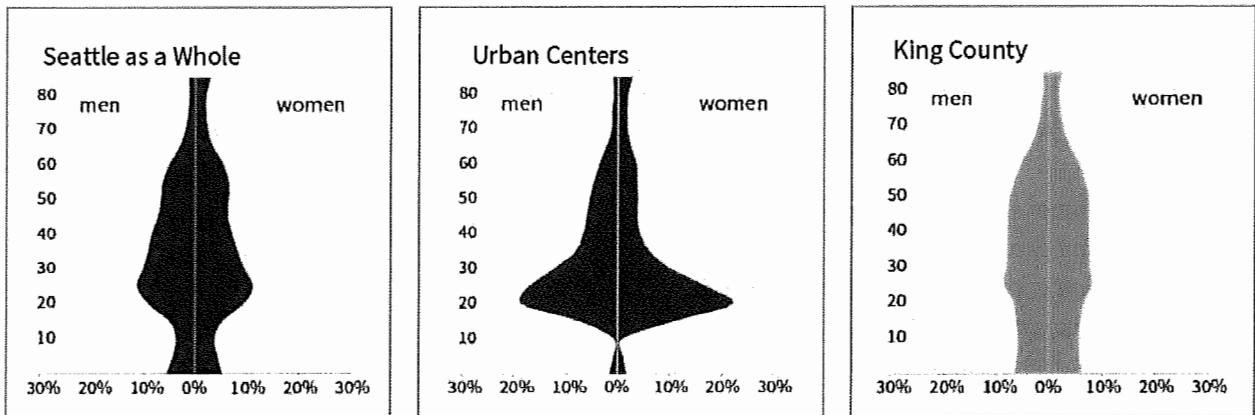

2010 percentages of population by age and gender

Seattle is becoming more racially and culturally diverse. The most recent estimates from the American Community Survey indicate that almost a fifth of Seattle residents were born in another country and that close to a quarter of residents speak a language other than English at home. The Seattle school district reports that among all of its students, 120 languages are spoken. The growing diversity in the city's population poses new challenges for City departments and other institutions as they strive to meet the needs of all residents. It also provides an opportunity to benefit from the cultures and skills of the people who make up these groups.

This Plan provides policy direction for locating new housing units and encourages a variety of housing types that can help meet the needs of diverse households who may be looking for studios, larger apartments, town houses, highrise apartments, or detached houses. By planning for more transportation choices, including bicycles and transit, the Plan will shape a city attractive to many potential future residents. This can include today's twenty-somethings who choose to remain in the city as they begin to have families, aging residents hoping to grow old in the place they've called home, and those who rely on transit for getting around. At the same time, the Plan's policies can make the city attractive to those critical businesses that provide jobs and services for Seattle residents.

Defining and Measuring Success

This Plan specifically covers the next twenty years of growth in Seattle, but the city is expected to continue growing beyond that time period. There will always be ways the city can improve to meet changing needs and to address ongoing concerns. Because of the changing nature of our region and our city, the success of this Plan is not measured by an ideal end state. Instead, success is measured by whether we are moving in the directions the Plan lays out.

The Plan covers many topics in several chapters, and monitoring progress on every one of those topics would be a time-consuming and demanding task. To simplify the monitoring process, the City has identified several indicators that could provide insights about progress on key issues addressed by the Plan. The City will report regularly on these indicators to help the public and elected officials judge the effectiveness of the Plan and the City's actions to implement it. Where data is available, the City will report it for each urban village to help assess each one's status. These indicators include

- *the number of new housing units;*
- *the number of jobs;*
- *the number of income- and rent-restricted affordable housing units;*
- *age, race, and household composition;*
- *access to frequent transit service;*
- *presence of sidewalks; and*
- *the number of households with access to open space.*

In addition to monitoring the items listed above, the City will use other indicators that will show how well it is doing to make the city a more equitable place. This set of indicators will help show where in the city marginalized populations are at higher risk of being displaced by development.

Developing and Updating This Plan

Seattle first adopted this Comprehensive Plan in 1994 after a multiyear effort during which residents throughout the city considered ways to shape the future of the city and to accommodate expected growth. Advisory committees, as well as public meetings and events, helped validate the urban village strategy.

The process that produced this current version of the Plan also involved much consultation with the public through a variety of meetings, events, and online conversations.

The GMA limits the City to amending the Plan only once each year, with exceptions for certain types of amendments that can be considered at any time, such as adoption of a new neighborhood plan or incorporation of the Shoreline Master Program. Since the Plan was first adopted, the City has amended it every year through a regular process that is defined in a City Council resolution. State law requires that the City review and update the Plan every eight years.

Application and Implementation of the Plan

The principal purpose of this Comprehensive Plan is to provide policies that guide the development of the city in the context of regional growth management. Community members and officials from all levels of government can look to these policies when planning for growth. The City will use the Plan to help make decisions about proposed ordinances, capital budgets, policies, and programs. Although the City will use the Plan to direct the development of regulations that govern land use and development, it will not use the Plan to review applications for specific development projects, except when an applicable development regulation expressly requires reference to this Comprehensive Plan.

Each element of this Plan generally presents goals followed by policies related to those goals and may also include a discussion about the goals and policies. Some chapters also have appendices. Each of these components is defined as follows.

Goals represent the results that the City hopes to realize over time, perhaps within the twenty-year life of the Plan, except where interim time periods are stated. Whether expressed in terms of numbers or only as directions for future change, goals are aspirations, not guarantees or mandates.

Policies should be read as if preceded by the words *It is the City's general policy to*. A policy helps to guide the creation of or changes to specific rules or strategies (such as development regulations, budgets, or program plans). City officials will generally make decisions on specific City actions by following ordinances, resolutions, budgets, or program plans

that themselves reflect relevant Plan policies, rather than by referring directly to this Plan. Implementation of most policies involves a range of City actions over time, so one cannot simply ask whether a specific action or project would fulfill a particular Plan policy. For example, a policy that states that the City will give priority to a particular need indicates that the City will treat the need as important, not that it will take precedence in every City decision.

Some policies use the words *shall*, *should*, *ensure*, *encourage*, and so forth. In general, such words describe the emphasis that the policy places on the action but do not necessarily establish a specific legal duty to perform a particular act, to undertake a program or project, or to achieve a specific result.

Some policies may appear to conflict with each other, particularly in the context of a specific situation or when viewed from the perspectives of people whose interests may conflict with a given policy. A classic example is the often-referenced “conflict” between policies calling for preservation of the environment and policies that promote economic development. Because Plan policies do not exist in isolation and must be viewed in the context of all potentially relevant policies, it is largely in applying these policies that the interests are reconciled and balanced by the legislative and executive branches of City government.

In the event that a conflict arises between another City policy and this Plan, the Plan will generally prevail.

Discussions are provided to explain the context in which decisions on goals and policies have been made, the reasons for those decisions, and how the goals and policies are related. The discussion portions of the Plan do not establish or modify policies; rather, they are intended to help explain or interpret policies.

Appendices to the Plan contain certain maps, inventories, and other information required by the GMA, and, in some cases, provide further data and discussion or analysis. The appendices are not to be read as establishing or modifying policies or requirements unless specified for such purposes in the Plan policies. For example, descriptions of current programs in an appendix do not require that these programs be continued, and detailed estimates of how the City may expect to achieve certain goals do not establish additional goals or requirements.

Implementing the Plan

The City carries the Plan forward through development regulations, functional plans, and investments. For instance, the City’s Land Use Code is a compilation of development regulations that guide how land in the city can be used. The Land Use element of this Plan provides the general direction for regulations that appear in the Land Use Code. Similarly, the Transportation element of this Plan provides direction for the Bicycle Master Plan and

Transit Master Plan, which help implement the Plan's transportation policies. The illustration on the next page shows the relationship among various City plans, this Plan, and regional plans.

While the City adopts regulations and plans for the various functions it performs, the private sector and other government agencies also help shape the city in significant ways. For example, the private sector builds most of the new housing and commercial space in the city, King County provides bus service, Sound Transit builds and provides light rail service, the school district builds and operates schools, the Port of Seattle operates shipping terminals that bring international trade to the city and the region, and the Washington State Department of Transportation builds and maintains state highways in the city. The City partners with these agencies to help them make decisions that best serve the City's goals. Implementation of this Plan is therefore a broadly shared effort that relies on the continued involvement of many individuals and institutions in the city and the region.

Growth Management Act
 Statewide Goals/Policies
 Guidance for Citywide Comprehensive Plans



PSRC Vision 2040
 Regional Growth Goals
 Regional Framework for Local Decisions
 Multi-County Planning Policies



King County Planning Policies
 Countywide Goals/Policies
 Countywide Growth Management



Seattle Comprehensive Plan
 Citywide Goals/Policies
 Neighborhood Goals/Policies
 Six-Year Capital Investment Plan



Implementation Tools

Examples of Implementing Plans	Examples of Codes & Rules in Seattle Municipal Code	Examples of Programs & Initiatives
<ul style="list-style-type: none"> • Pedestrian Master Plan • Bicycle Master Plan • Transit Master Plan • Freight Master Plan • Move Seattle Action Plan • Consolidated Plan for Housing and Community Development • Parks Legacy Plan • SPU Stormwater Management Plan • SPU Solid Waste Plan • City Light Strategic Plan • My Library Strategic Plan • Climate Action Plan • Disaster Recovery Framework 	<ul style="list-style-type: none"> • Land Use Code • Stormwater Code • Environmentally Critical Areas (ECA) Code • Historic Preservation • Environmental Protection • Street and Sidewalk Use • Parks and Recreation 	<ul style="list-style-type: none"> • Move Seattle Levy • Housing Levy • Seattle Park District • Seattle Homeowner Stabilization Program • Multifamily Property Tax Exemption (MFTE) Credit Program • Neighborhood Matching Fund • City Light Appliance Rebate Program • Public Art Program • Green Stormwater Infrastructure Program • Fire and Emergency Response Levy • Food Action Plan

Growth Strategy



Introduction

Seattle's strategy for accommodating future growth and creating a sustainable and equitable city builds on the foundation of its many diverse neighborhoods and aims to create a better city by providing

- *a variety of housing options,*
- *locations for employment growth,*
- *walkable communities with good transit access,*
- *services and the infrastructure needed to support growth,*
- *respect for the natural environment and enhancements to the city's cultural resources,*
- *and*
- *growth that enables all residents to participate fully in the city's economy and civic life.*



This Plan envisions a city where growth builds stronger communities, heightens our stewardship of the environment, leads to enhanced economic opportunity and security for all residents, and is accompanied by greater race and social equity across Seattle's communities.

This element of the Plan describes how the City goes about planning for growth and how it involves others in that planning. It also describes the City's urban village strategy—the idea that most of Seattle's growth should occur in the urban centers, urban villages, and manufacturing/industrial centers. This element also presents policies about urban design that describe how decisions about the location of growth should interact with the natural and built environments.

Other elements of this Plan describe mechanisms the City will use to achieve the growth vision. For example, the **Land Use element** describes how zoning and development regulations will control the location and sizes of new buildings in ways that help carry out the urban village strategy, the **Transportation element** describes the systems the City will provide to enable people and goods to move around the city, and the **Housing element** includes policies that will guide the types of housing the City will aim for and the tools the City will use to make it possible for people who work in the city to live here as well.

Community Engagement

Discussion

In addition to this Plan, the City also prepares more detailed plans and regulations that guide the specific activities of City departments. The City has a history of encouraging community participation in the development of City plans. In recent years, the City has been even more deliberate in reaching out to underrepresented communities so that their opinions and needs are reflected in the City's plans and programs. As the makeup of the city's population continues to change, the City will need to increase these outreach efforts to ensure that growing segments of the community are represented in the choices the City will make. Enhanced participation in planning and in decision-making can help create opportunities for everyone, regardless of race or means. It can also help balance how the benefits of growth are distributed across the city.

Between 2000 and 2010, the population of people of color grew more quickly than the total population in Seattle as a whole and within most urban villages. However, in some urban villages the pattern has been different. For example, 23rd and Union/Jackson, North Beacon Hill, and Columbia City saw substantial decreases in their populations of color.

Changes in Population 2000 to 2010

	Change in Total Pop.	Change in Pop. of Color	% Change in Total Pop.	% Change in Pop. of Color
Seattle total	45,286	24,240	8.0%	13.4%
Inside urban villages	30,544	15,883	17.1%	22.9%
Outside urban villages	14,742	8,357	3.8%	7.5%

Planning is a process that continues beyond the production of a document. It requires continual monitoring of conditions that the Plan was intended to affect. Over time, new people will move into the city and into individual urban villages, and the City will need to engage these new residents and business owners to test whether the Plan’s vision, goals, and policies continue to reflect the current population and circumstances.

GOAL

- GS G1** Continue to have meaningful opportunities for all people in Seattle to contribute their thoughts and aspirations to City processes that develop growth plans and related regulations.

POLICIES

- GS 1.1** Enlist Seattle residents and businesses to help prepare plans that guide growth, City government activities, and City services so that the outcomes reflect the public’s values and concerns.
- GS 1.2** Develop and implement practices to reach historically underrepresented communities and to aid their participation in decision-making processes.
- GS 1.3** Maintain an updating process for this Plan that is predictable and transparent to the public, with opportunities for public involvement.
- GS 1.4** Monitor development activity in urban centers and villages to track changes in the number of housing units, jobs, and population and evaluate whether development is consistent with this Plan.
- GS 1.5** Use information collected about growth, along with other information, to make decisions for further planning or for making investments that will meet the needs of residents and businesses.
- GS 1.6** Monitor development activity and other factors that will identify areas with high potential for displacement of marginalized populations and small businesses.

- GS 1.7** Develop and implement strategies that can limit displacement of marginalized populations.
- GS 1.8** Engage local communities, particularly in neighborhoods with marginalized populations, to identify and jointly address unique housing and community amenity or service needs.
- GS 1.9** Use relevant, respectful, and innovative ways to encourage broad participation in neighborhood and community activities and events.
- GS 1.10** Partner with other governments, schools, institutions, and community-based organizations to involve people of all backgrounds meaningfully in planning and decision-making that impact their communities.

Urban Village Strategy

Discussion

The urban village strategy is this Plan's approach to managing growth. This strategy concentrates most of the city's expected future growth in urban centers and urban villages. Most of these areas have been the commercial centers serving their local communities or even the larger city and region for decades. They are the places best equipped to absorb more housing and businesses and to provide the services that new residents and employees will need.

Urban centers and villages are almost like small cities within Seattle. They are complete and compact neighborhoods. Increasing residential and employment opportunities in urban centers and villages makes transit and other public services convenient for more people. It also makes providing these key services more efficient. This can be a benefit to transit-dependent populations and to those who rely on other community services. At the same time, locating more residents, jobs, stores, and services near each other will reduce people's reliance on cars, limit traffic congestion, and decrease greenhouse gas emissions.

The urban village strategy takes the unique character of the city's neighborhoods into account when planning for future growth. The places selected for absorbing the most growth come in various shapes and sizes, and they will serve somewhat different purposes. The following descriptions define the roles that four different types of areas will play in the city's future:

Urban centers are the densest Seattle neighborhoods. They act as both regional centers and local neighborhoods that offer a diverse mix of uses, housing, and employment opportunities.

Hub urban villages are communities that offer a balance of housing and employment but are generally less dense than urban centers. These areas provide a mix of goods, services, and employment for their residents and surrounding neighborhoods.

Residential urban villages are areas of residential development, generally at lower densities than urban centers or hub urban villages. While they are also sources of goods and services for residents and surrounding communities, for the most part they do not offer many employment opportunities.

Manufacturing/industrial centers are home to the city's thriving industrial businesses. Like urban centers, they are important regional resources for retaining and attracting jobs and for maintaining a diversified economy.

The City intends for each of these areas to see more growth and change over time than other commercial locations or primarily residential areas, and together they will accommodate the majority of the city's expansion during this Plan's life span. The City will continue to work with its residents, businesses, and institutions citywide to promote conditions that will help each of its communities thrive, but it will pay special attention to the urban centers and villages where the majority of the new housing and jobs is expected. The policies in this Plan provide direction for that change and growth.

Because the City expects to concentrate public facilities, services, and transit in urban centers and urban villages, it must ensure that there are opportunities for all households to find housing and employment in those places, regardless of income level, family size, or race.

In addition to designating urban centers and villages and defining the desired conditions in these locations, the Plan addresses conditions in other areas, including large areas of single-family development, smaller areas of multifamily and commercial uses, and a few small industrial areas. These areas will also experience some growth, although generally in less dense patterns than the urban villages because these areas tend to lack some of the infrastructure needed for more dense development and some of these areas are not within easy walking distance of services.

GOAL

GS G2 Keep Seattle as a city of unique, vibrant, and livable urban neighborhoods, with concentrations of development where all residents can have access to employment, transit, and retail services that can meet their daily needs.

POLICIES

GS 2.1 Designate places as urban centers, urban villages, or manufacturing/industrial centers based on the functions they can perform and the densities they can support.

- GS 2.2** Encourage investments and activities in urban centers and urban villages that will enable those areas to flourish as compact mixed-use neighborhoods designed to accommodate the majority of the city's new jobs and housing.
- GS 2.3** Establish boundaries for urban centers, urban villages, and manufacturing/ industrial centers that reflect existing development patterns; potential access to services, including transit; intended community characteristics; and recognized neighborhood areas.
- GS 2.4** Coordinate planning for transportation, utilities, open space, libraries, and other public services to meet the anticipated growth and increased density in urban centers and villages.
- GS 2.5** Encourage infill development in underused sites, particularly in urban centers and villages.
- GS 2.6** Plan for development in urban centers and urban villages in ways that will provide all Seattle households, particularly marginalized populations, with better access to services, transit, and educational and employment opportunities.
- GS 2.7** Promote levels of density, mixed-uses, and transit improvements in urban centers and villages that will support walking, biking, and use of public transportation.
- GS 2.8** Use zoning and other planning tools to shape the amount and pace of growth in ways that will limit displacement of marginalized populations, community services, and culturally relevant institutions and businesses.
- GS 2.9** Distribute public investments to address current inequities, recognizing the need to also serve growing communities.
- GS 2.10** Establish urban centers and urban villages using the guidelines described in Growth Strategy Figure 1.

Growth Strategy Figure 1

Urban Center and Urban Village Guidelines

Characteristic	Urban Centers*	Hub Urban Villages	Residential Urban Villages
Land Area	Up to 1.5 square miles (960 acres)	At least 20 contiguous acres of land currently zoned to accommodate commercial or mixed-use activities	At least 10 acres of commercial zoning within a radius of 2,000 feet
Public Transit Access	Within 0.5 miles of the existing or planned high-capacity transit station Existing or planned connections to surrounding neighborhoods by bicycle lanes and/or sidewalks	Transit service with a frequency of 15 minutes or less during peak hours and 30 minutes or less during off-peak hours, with direct access to at least one urban center Connected to neighboring areas and nearby public amenities by existing or planned bicycle lanes and/or sidewalks	Transit service with a frequency of 15 minutes or less during peak hours and 30 minutes or less during off-peak hours, with direct access to at least one urban center Connected to neighboring areas and nearby public amenities by existing or planned bicycle lanes and/or sidewalks
Zoning and Use	Zoning that allows for a diverse mix of commercial and residential activities	Zoning that allows a range of uses, including a variety of housing types as well as commercial and retail services serving a local, citywide, or regional market, generally at a lower scale than in urban centers	Zoning that emphasizes residential uses while allowing for commercial and retail services for the village and surrounding area, generally at a lower scale than in hub urban villages
Growth Accommodation	Zoning that permits <ul style="list-style-type: none"> a minimum of 15,000 jobs within 0.5 miles of a high-capacity transit station an overall employment density of 50 jobs per acre, and an overall residential density of 15 households per acre 	Zoning that permits at least <ul style="list-style-type: none"> 15 dwelling units per gross acre 25 jobs per gross acre 2,500 total jobs, and 3,500 dwelling units 	Zoning that permits at least 12 dwelling units per gross acre

*The urban center description was taken from King County Countywide Planning Policies.

GS 2.11 Permit various sizes of urban villages based on local conditions, but limit sizes so that most places in the village are within walking distance from employment and service areas in the village.

- GS 2.12** Include the area that is generally within a ten-minute walk of light rail stations or very good bus service in urban village boundaries.
- GS 2.13** Provide opportunities for marginalized populations to live and work in urban centers and urban villages throughout the city by allowing a variety of housing types and affordable rent levels in these places.
- GS 2.14** Support convenient access to healthful and culturally relevant food for all areas where people live by encouraging grocery stores, farmers' markets, and community food gardens.
- GS 2.15** Designate areas as manufacturing/industrial centers consistent with the following characteristics and with the Countywide Planning Policies:
- Existing zoning that promotes manufacturing, warehousing, and distribution uses
 - Zoning that discourages uses that pose short- or long-term conflicts with industrial uses, or that threaten to convert significant amounts of industrial land to nonindustrial uses
 - Zoning that strictly limits residential uses and discourages land uses that are not compatible with industrial uses
 - Buffers that protect neighboring, less intensive land uses from the impacts associated with industrial activity (provided by generally maintaining existing buffers, including existing industrial buffer zones)
 - Sufficient zoning capacity to accommodate a minimum of ten thousand jobs
 - Relatively flat terrain allowing for efficient industrial processes
 - Reasonable access to the regional highway, rail, air, and/or waterway systems for transportation of goods
- GS 2.16** Use zoning and other tools to maintain and expand existing industrial activities within the manufacturing/industrial centers.
- GS 2.17** Limit City-owned land in the manufacturing/industrial centers to uses that are compatible with other industrial uses and that are inappropriate in other zones, and discourage other public entities from siting nonindustrial uses in manufacturing/industrial centers.

Areas Outside Centers and Villages

- GS 2.18** Support healthy neighborhoods throughout the city so that all residents have access to a range of housing choices, as well as access to parks, open space, and services.
- GS 2.19** Allow limited multifamily, commercial, and industrial uses outside of urban villages to support the surrounding area or to maintain the existing character.
- GS 2.20** Plan for uses and densities on hospital and college campuses that are located outside urban centers and villages in ways that recognize the important contributions of these institutions and the generally low-scale development of their surroundings.

Distribution of Growth

Discussion

The City does not completely control where growth will take place. The City adopts zoning that allows certain types of development in particular locations, and the City can make certain places attractive to development by making investments or offering incentives in those places. However, most new development is the result of decisions made by private landowners or developers who choose where they want to build.

Guided by the urban village strategy, the City has adopted zoning that will lead the bulk of Seattle's future growth to take place in areas designated as urban centers and urban villages. The City's vision is that job growth will be concentrated in urban centers—areas that already function as high-density, concentrated employment cores with the most access to the regional transit network. The City will especially focus growth in urban centers and those urban villages that are within easy walking distance of frequent and reliable transit service.

Currently, jobs and households are unevenly distributed across Seattle. For instance, the four adjoining urban centers (Downtown, First Hill/Capitol Hill, South Lake Union, and Uptown) contain almost a fifth of the City's households and nearly half of the city's jobs—on less than 5 percent of the city's land. Downtown alone has about ten times more jobs than housing units. Future growth estimates show that these urban centers will likely continue to be major job centers.

Industrial job growth will continue to take place mostly within the City's two existing and well-established manufacturing/industrial centers. There will also be overall job growth in hub urban villages distributed throughout the city, which will put jobs and services closer to the surrounding residential population. Urban villages that contain very good transit service are expected to grow more than those without that service. Very good transit means either a light rail station or a RapidRide stop plus at least one other frequent bus route. Two urban villages—Rainier Beach and Othello—that have light rail stations also are at high risk of too much development displacing existing households or small businesses. The City wants these areas to benefit from growth and investment, but we also need to pay attention to how growth can increase the risk of displacing marginalized populations and small businesses. To mitigate the risk, the Plan assigns a growth rate to these urban villages that is the same as for the residential villages that do not meet the definition for very good transit service. As the City monitors urban village growth in the future, the smaller growth rates for these two urban villages will help us examine the potential for displacement. Growth Strategy Figure 4 shows the different categories of urban villages, along with their level of transit service.

More modest growth will occur in various places outside centers and villages, including along arterials where current zoning allows multifamily and commercial uses.

This Plan anticipates that over the next twenty years, Seattle will add 70,000 housing units and 115,000 jobs. These estimates represent the city's share of King County's projected twenty-year growth.

GOAL

GS G3 Accommodate a majority of the city's expected household growth in urban centers and urban villages and a majority of employment growth in urban centers. (Figure 2 shows the estimated amount of growth for each urban center, and Figure 3 shows the estimated growth rate for different categories of urban villages.)

Growth Strategy Figure 2

Estimated Urban Center Growth 2015–2035

	Housing Units	Jobs
Urban Centers		
Downtown	12,000	35,000
First Hill/Capitol Hill	6,000	3,000
University District	3,500	5,000
Northgate	3,000	6,000
South Lake Union	7,500	15,000
Uptown	3,000	2,500
Manufacturing/Industrial Centers		
Duwamish	0	6,000
Ballard/Interbay	0	3,000

Growth Strategy Figure 3

Estimated Urban Village Growth Rates

	Expected Housing Growth Rate*	Expected Job Growth Rate*
Hub Urban Villages	40%	50%
With very good transit service**	60%	50%
With high displacement risk and low access to opportunity, regardless of the level of transit service	40%	50%
Residential Urban Villages	30%	N/A
With very good transit service**	50%	N/A
With high displacement risk and low access to opportunity, regardless of the level of transit service	30%	N/A

*Percentage growth above the actual number of housing units or jobs in 2015, except where limited by zoning capacity. No job growth rate is assigned to residential villages.

**Very good transit service means either a light rail station or a RapidRide bus service plus at least one other high-frequency bus route.

POLICIES

GS 3.1 Plan for a variety of uses and the highest densities of both housing and employment in Seattle’s urban centers, consistent with their role in the regional growth strategy.

GS 3.2 Base twenty-year growth estimates for each urban center and manufacturing/ industrial center on the following criteria:

- Citywide targets for housing and job growth adopted in the Countywide Planning Policies
- The role of the center in regional growth management planning
- The most recently adopted subarea plan for the center
- Level of transit service
- Existing zoning capacity for additional commercial and residential development
- Existing densities
- Current development conditions, recent development trends, and plans for private or public development, such as by major institutions

Growth Strategy Figure 4

Urban Centers, Urban Villages, Manufacturing/Industrial Centers

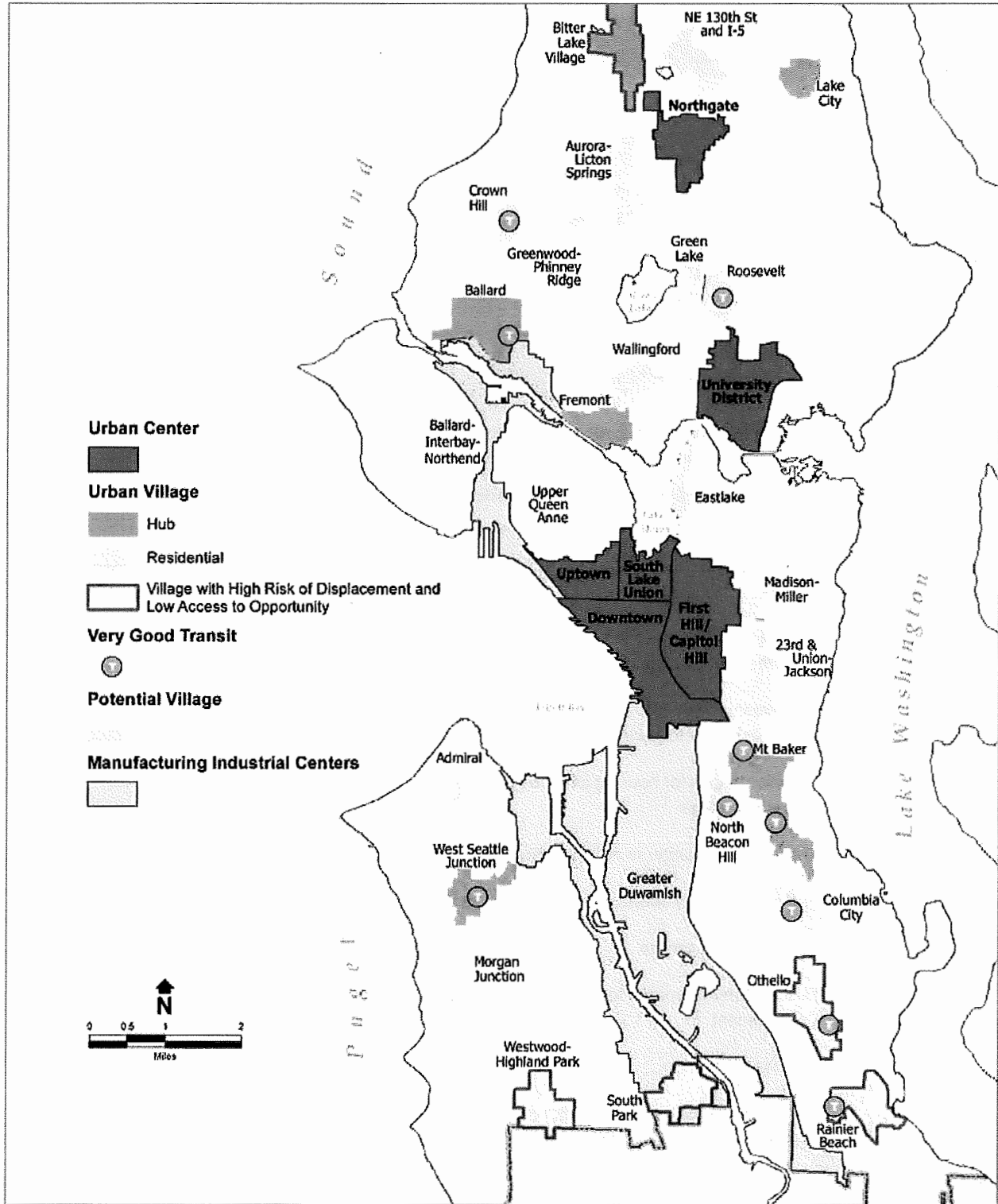

- Plans for infrastructure, public amenities, and services that could attract or support additional growth
- Access to employment for, and potential displacement of, marginalized populations

GS 3.3 Accommodate a substantial portion of the city's growth in hub and residential urban villages.

GS 3.4 Work toward a distribution of growth that eliminates racial and social disparities by growing great neighborhoods throughout the city, with equitable access for all and with community stability that reduces the potential for displacement.

GS 3.5 Adjust urban center growth estimates periodically to reflect the most current policy guidance in regional and countywide growth management plans, or reexamine estimates as plans for the city's urban centers are substantially amended.

Urban Design

Discussion

As Seattle evolves, thoughtful urban design can help both conserve and enhance the aspects of its physical environment that make it so appealing to residents and visitors alike. These aspects include well-defined and diverse mixed-use neighborhoods; compact, walkable scale; proximity to nature; and attractive parks, streets, and public spaces. In a flourishing city, urban design can help seamlessly integrate the new with the old, producing positive results while limiting the negative impacts of change. The policies in this element concern broad choices the City might make about where and how to develop.

For example, several Seattle neighborhoods are designated as historic districts in an effort to preserve their distinctive characters. The way the City builds and maintains major infrastructure, including parks and roads, will continue to define key public spaces and the connections between them.

The urban design policies described here outline the City's approaches to regulating, building, and maintaining the city, while reflecting its diverse neighborhoods, populations, and natural features. The policies here are separated into three specific areas of focus: Natural Environment, Built Environment, and Public Spaces. More detailed direction for individual projects can be found in the Land Use Code's regulations and in the City's design guidelines.

The policies in this element are not intended to be used for reviewing individual projects. Rather, the City helps shape projects through zoning regulations and the design review program.

GOAL

- GS G4** Maintain and enhance Seattle's unique character and sense of place, including its natural setting, history, human-scaled development, and community identity, as the city grows and changes.

Natural Environment

POLICIES

- GS 4.1** Encourage the preservation, protection, and restoration of Seattle's distinctive natural features and landforms such as bluffs, beaches, streams, and remaining evergreen forests.
- GS 4.2** Design public facilities to emphasize physical and visual connections to Seattle's natural surroundings, with special attention to public vistas of shorelines, the Olympic Mountains, and the Cascade Range.
- GS 4.3** Encourage design that recognizes natural systems and integrates ecological functions such as stormwater filtration or retention with other infrastructure and development projects.
- GS 4.4** Respect topography, water, and natural systems when siting tall buildings.
- GS 4.5** Provide both physical and visual public access to streams, lakes, and Puget Sound.
- GS 4.6** Extend sustainable landscaping and an urban design approach to typically underdesigned sites such as surface parking lots, rooftops, and freeway edges.
- GS 4.7** Promote the use of native plants for landscaping to emphasize the region's natural identity and foster environmental health.

Built Environment

- GS 4.8** Preserve characteristics that contribute to communities' general identity, such as block and lot patterns and areas of historic, architectural, or social significance.
- GS 4.9** Design public infrastructure and private building developments to help visitors understand the existing block and street patterns and to reinforce the walkability of neighborhoods.
- GS 4.10** Use zoning tools and natural features to ease the transitions from the building intensities of urban villages and commercial arterials to lower-density developments of surrounding areas.
- GS 4.11** Design streets with distinctive identities that are compatible with a citywide system that defines differences between types of streets and that allows for different design treatments to reflect a particular street's function, right-of-way width, and adjoining uses.

- GS 4.12** Preserve, strengthen, and, as opportunities permit, reconnect Seattle's street grid as a means to knit together neighborhoods and to connect areas of the city.
- GS 4.13** Design urban villages to be walkable, using approaches such as clear street grids, pedestrian connections between major activity centers, incorporation of public open spaces, and commercial buildings with retail and active uses that flank the sidewalk.
- GS 4.14** Design multifamily zones to be appealing residential communities with high-quality housing and development standards that promote privacy and livability, such as appropriately scaled landscaping, street amenities, and, in appropriate locations, limited commercial uses targeted for the local population.
- GS 4.15** Encourage designs for buildings and public spaces that maximize use of natural light and provide protection from inclement weather.
- GS 4.16** Encourage the use of land, rooftops, and other spaces to contribute to urban food production.
- GS 4.17** Use varied building forms and heights to enhance attractive and walkable neighborhoods.
- GS 4.18** Use groupings of tall buildings, instead of lone towers, to enhance overall topography or to define districts.
- GS 4.19** Consider taller building heights in key locations to provide visual focus and define activity centers, such as near light rail stations in urban centers and urban villages.
- GS 4.20** Limit the negative impacts of tall buildings on public views and on sunlight in public streets and parks by defining upper-level building setbacks and lot coverage or by using other techniques.
- GS 4.21** Locate tall buildings to respect natural surroundings and key natural features and to minimize obstructing views of these features, such as by having lower building heights near lakes or Puget Sound.
- GS 4.22** Encourage street widths and building heights that are in proportion with each other by reducing setbacks from the street and keeping reasonable sidewalk widths for lower buildings.

Public Spaces

- GS 4.23** Encourage innovative street design that expands the role of streets as public spaces and that could include use for markets, festivals, or street parks.
- GS 4.24** Promote well-defined outdoor spaces that can easily accommodate potential users and that are well integrated with adjoining buildings and spaces.
- GS 4.25** Design public spaces that consider the nearby physical context and the needs of the community.

- GS 4.26** Use the principles of crime prevention through environmental design for public spaces, where appropriate.

Annexation

Discussion

Small areas of unincorporated land lie immediately south of the Seattle city limits. The King County government currently administers services to these areas. However, the state's Growth Management Act (GMA) anticipates that all areas within the county's urban growth boundary will eventually be part of a city. Figure 5 shows the locations Seattle has identified as potential annexation areas.

GOAL

- GS G5** Eliminate pockets of unincorporated land abutting Seattle.

POLICIES

- GS 5.1** Cooperate with adjacent jurisdictions in order to reach equitable and balanced resolutions about jurisdictional boundaries for the remaining unincorporated areas abutting city limits.
- GS 5.2** Designate unincorporated land for potential annexation where the area has access, or can easily be connected, to City services, and the boundary-change agreements will result in an equitable distribution of revenues and costs, including asset transfer and the development, maintenance, and operation of facilities.
- GS 5.3** Consider annexation requests by the residents of unincorporated areas as a way for the City to meet regional growth management goals.
- GS 5.4** Support annexations of unincorporated areas to surrounding jurisdictions by taking part in public engagement efforts to determine local sentiment and in developing interlocal agreements related to annexations.

Growth Strategy Figure 5

Potential Annexation Areas

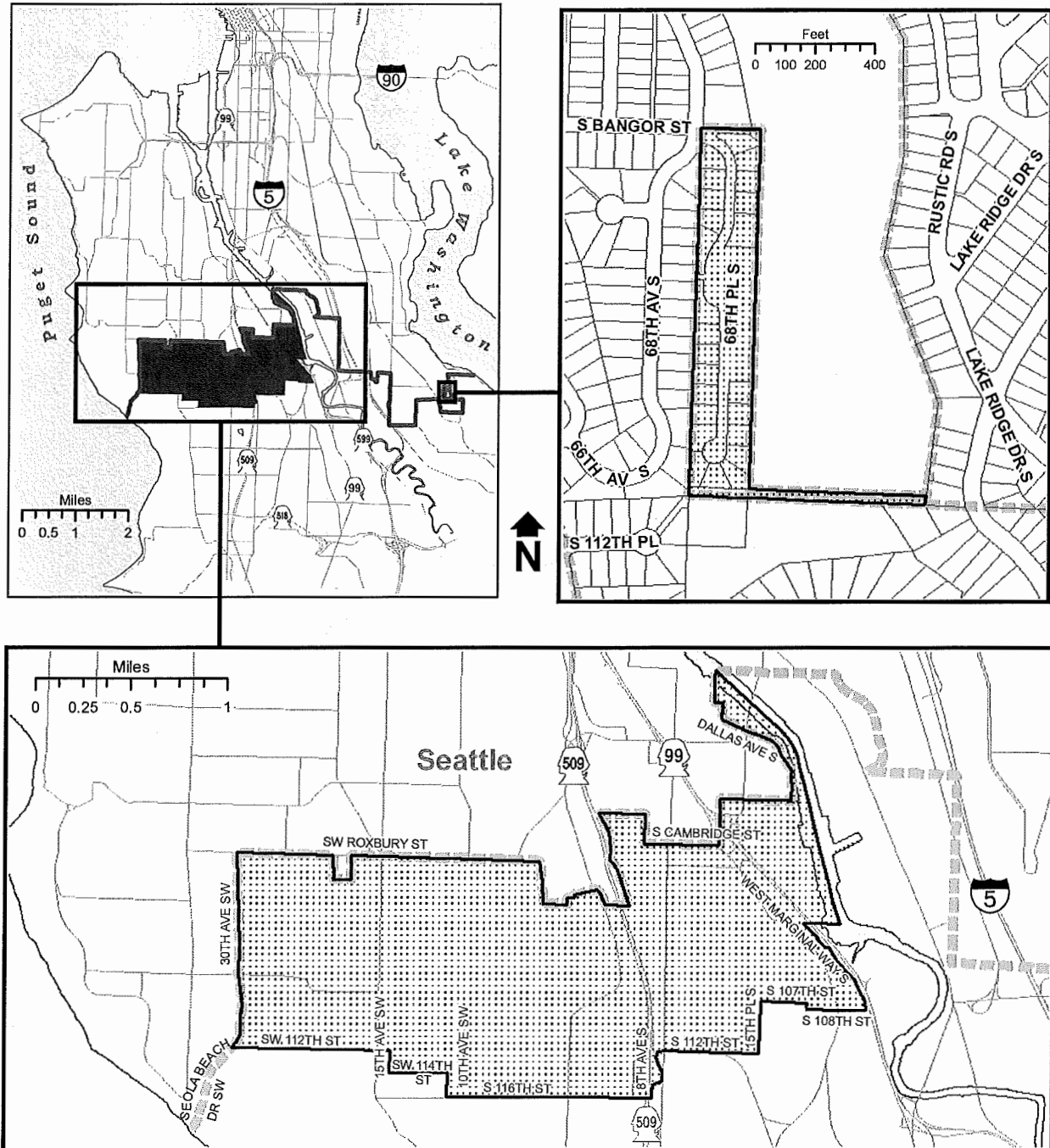

Potential Annexation Area
 Seattle City Limit

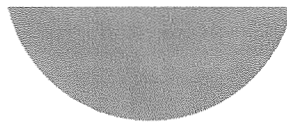

Land Use



Introduction

Land use choices affect how Seattle looks and feels to visitors and how it functions for those who call it home. This Plan's land use policies follow the urban village strategy. They help guide new housing and businesses to the urban centers and villages and help design the actual buildings and public spaces. The land use policies also recognize the character of the city's different neighborhoods, part of what makes Seattle such an attractive place to live.

Seattle is a "built city." That means we don't have a lot of vacant land where we can put new buildings. It also means that the land use goals and policies need to fit more jobs and housing into our existing communities. To help everyone to share in the benefits of growth, the land use policies steer most new development toward the urban centers and urban villages that are accessible by public transit and that have the goods, services, and amenities that people want. And while growth and change bring good things to the city, we don't want the

Seattle of the future to leave anyone behind. As we grow, we need to provide more housing and other services for the most vulnerable among us.

You see these policies in action when you notice a difference in the location, type, and size of new buildings. Guided by the urban village strategy, the City's Land Use Code (Seattle Municipal Code Title 23) includes a map showing the zones that define the types of buildings allowed. Detailed regulations tell developers what the buildings in each zone can look like. The zones themselves are grouped in the Land Use Code under general categories such as single-family zones, which are composed mostly of houses, and commercial/mixed-use zones, which include businesses as well as housing. Multifamily zones include apartment buildings, town houses, and condos, while industrial zones create space for the port and manufacturing to thrive. Downtown has its own zone type for dense, highrise office and residential buildings.

In Seattle, as in other cities, household incomes and the housing options that people can afford tend to vary by race and ethnicity. Roughly half of Seattle's households live in single-unit housing. Household of color are more likely to reside in multifamily housing even though they have more people per household on average. The same is true for households with a foreign-born householder.

Type of Housing

By Characteristics of Seattle Householders

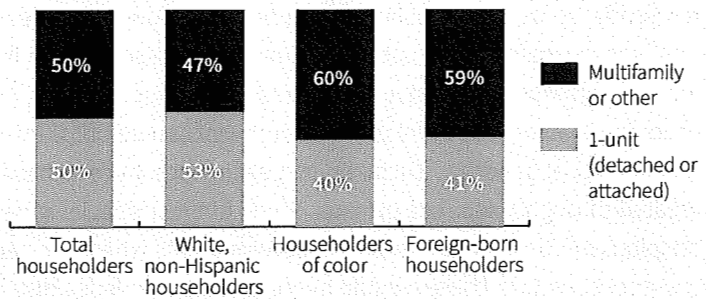

Source: 2011–2013 American Community Survey (ACS), US Census Bureau

This Land Use element is divided into three sections. The first section has policies that affect the city as a whole. These policies speak to how Seattle should change and grow in the years to come. The Future Land Use Map shows us the shape of this next-generation Seattle. The second section talks about each kind of land use area: single-family, multifamily, commercial/mixed-use, industrial, and Downtown. The policies in this section explain what makes each of these land use areas different. The third section contains policies for places that play special roles—for example, historic districts.

The **Land Use Appendix** provides information about the amount of land being used for different purposes across the city. It also displays the density of housing, population, and jobs throughout the city.

Citywide Land Use Policies

Citywide land use policies guide the content and interpretation of the City's Land Use Code, which contains detailed regulations about where and how activities on the land may be changed. These regulations are applied geographically by zone. Unless a difference is noted, policies in this section apply across all zones.

The Future Land Use Map and Locations of Zones

Discussion

The Future Land Use Map shows distinct land use designations or types that are located around the city. The City has decided the right uses for each area and how much use each area should receive. Five of these area types—single-family residential areas, multifamily residential areas, commercial/mixed-use areas, Downtown areas, and industrial areas—are meant to suggest specific uses. One area might be good for building more homes or right for building shops and restaurants. Within each land use area, there may be different levels of zoning that provide more detail about what can be built. This ensures that the right types and density of buildings will be built in each place. In certain places, special zoning can be created through a separate process. Some of these special zones are created around large hospitals or universities or housing developments where the needs of many people need to be coordinated. These include major institution overlay districts and master planned communities. Four other types of areas on the Future Land Use Map show the urban village strategy in use. Urban centers, hub urban villages, residential urban villages, and manufacturing/industrial centers work together with the land use area designations. They show us the best spots to place new housing and jobs and the right places for manufacturing, warehousing, and port activity.

As the city's needs and priorities shift, the Future Land Use Map may be changed or formally amended. Some changes, such as adjusting boundaries or moving around specific zones within the same general land use area or urban village, can be made without a formal amendment or change to the map.

Actual zones that are used to regulate new buildings are identified on the City's Official Land Use Map. This map is part of the Plan's regulatory structure and can be found in the Land Use Code. Sometimes landowners want to change the type or size of the buildings they can build on their land. Changing the zoning of a particular area or site is a formal process that requires City Council approval. When a landowner applies for a rezone, the City looks to see if the change matches up with the Future Land Use Map, follows the Land Use Code, and fits with the surrounding area and the neighborhood.

Future Land Use Map

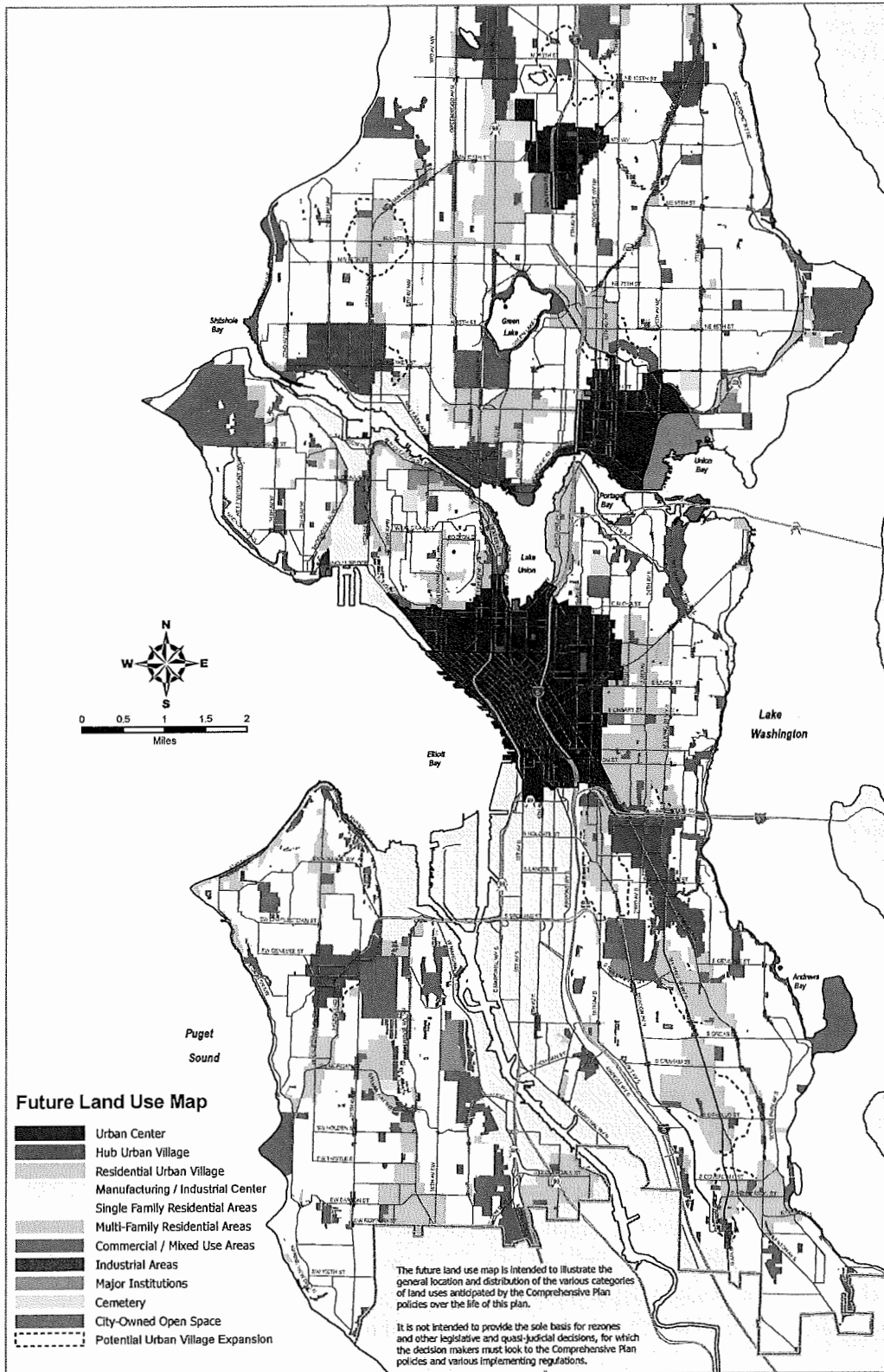

GOAL

- LU G1** Achieve a development pattern consistent with the urban village strategy, concentrating most new housing and employment in urban centers and villages, while also allowing some infill development compatible with the established context in areas outside centers and villages.

POLICIES

- LU 1.1** Use the Future Land Use Map to identify where different types of development may occur in support of the urban village strategy.
- LU 1.2** Promote this plan's overall desired land use pattern through appropriate zoning that regulates the mix of uses as well as the size and density of development to focus new residential and commercial development in urban centers and urban villages, and integrate new projects outside of centers and villages into the established development context.
- LU 1.3** Provide for a wide range in the scale and density permitted for multifamily residential, commercial, and mixed-use projects to generally achieve the following overall density and scale characteristics:
- In urban centers, a moderate to high-density and scale of development
 - In hub urban villages, a moderate density and scale of development
 - In residential urban villages, a low to moderate density and scale of development
- LU 1.4** Provide a gradual transition in building height and scale inside urban centers and urban villages where they border lower-scale residential areas.
- LU 1.5** Require Future Land Use Map amendments only when needed to achieve a significant change to the intended function of a large area.

Uses

Discussion

The City regulates or controls how Seattle land is used through zoning. Each zone comes with a specific set of rules defining what types of uses are allowed in that area. Regulating how we use land in Seattle is important for many reasons. It allows us to plan for new people and businesses that come into the city and to look into the future. It allows goods and services to be located where they are needed most and helps us put jobs and housing in the places that match our vision. Regulations can also help smooth transitions between zones. Zoning helps Seattle remain a city of diverse neighborhoods, each with its own character and special features. Regulating how we use our land also helps us meet the common

needs of all Seattleites for jobs, housing, services, and access to amenities and cultural resources.

GOAL

- LU G2** Provide zoning and accompanying land use regulations that
- allow a variety of housing types to accommodate housing choices for households of all types and income levels;
 - support a wide diversity of employment-generating activities to provide jobs for a diverse residential population, as well as a variety of services for residents and businesses; and
 - accommodate the full range of public services, institutions, and amenities needed to support a racially and economically diverse, sustainable urban community.

POLICIES

- LU 2.1** Allow or prohibit uses in each zone based on the zone's intended function as described in this Land Use element and on the expected impacts of a use on other properties in the zone and the surrounding area. Generally allow a broad mix of compatible uses in the urban centers and urban villages.
- LU 2.2** Include provisions to potentially allow as conditional uses those activities that may be beneficial to an area but that also require additional measures to avoid potential impacts those activities could have on sensitive environments or on other permitted uses.
- LU 2.3** Allow residential use outright or as a conditional use in all zones except industrial zones and those shoreline areas where residential uses may conflict with the intended function of the shoreline environment.
- LU 2.4** Limit nonresidential uses in residential zones to those necessary or highly compatible with the function of residential neighborhoods.
- LU 2.5** Allow nonconforming uses to be maintained and enhanced, but generally not to be expanded or extended, and encourage them to become more conforming over time.
- LU 2.6** Avoid introducing incompatible land uses adjacent to or within the Airport Influence Area of commercial service airports.
- LU 2.7** Review future legislative rezones to determine if they pose a risk of increasing the displacement of residents, especially marginalized populations, and the businesses and institutions that serve them.
- LU 2.8** Evaluate new land use regulations to determine if there are potential adverse outcomes that may affect marginalized populations or other groups or individuals unfairly, and seek to avoid or mitigate such potential outcomes.



Special Uses: Public Facilities and Small Institutions

Discussion

Throughout Seattle our communities are dotted with facilities that provide needed services to local residents. These include schools, fire and police stations, and other buildings that serve special functions that require them to be different from other buildings in the same zone. For instance, fire stations may need extra room for trucks, and schools need to be much larger than the single-family houses around them. Similar issues sometimes arise with facilities and small institutions not operated by the public sector, such as churches, private schools, and nursing homes.

GOAL

- LU G3** Allow public facilities and small institutions to locate where they are generally compatible with the function, character, and scale of an area, even if some deviation from certain regulations is necessary.

POLICIES

- LU 3.1** Regulate public facilities and small institutions to promote compatibility with other developments in the area.
- LU 3.2** Allow public facilities and small institutions to depart from development standards, if necessary to meet their particular functional requirements, while maintaining general design compatibility with the surrounding area's scale and character. Require public facilities and small institutions to adhere to zoned height limits, except for schools and spires on religious institutions.
- LU 3.3** Allow standards to be modified for required off-street parking associated with public facilities and small institutions based on the expected use and characteristics of the facility and the likely impacts on surrounding parking and development conditions, and on existing and planned transportation facilities in the area.
- LU 3.4** Avoid clusters of public facilities and small institutions in residential areas if such concentrations would create or further aggravate parking shortages, traffic congestion, and noise in the area.
- LU 3.5** Allow nonconforming public facilities and small institutions to expand or make structural changes, provided these alterations comply with the zone's development standards and do not increase the structure's nonconformity.
- LU 3.6** Allow buildings no longer used as schools to be put to other uses not otherwise permitted in the applicable zone. Base decisions about these uses on criteria that are established for each vacant school as the need arises, through a process that includes Seattle Public Schools, the City, and the surrounding neighborhood.

Special Uses: Telecommunication Facilities

Discussion

Cell phone service providers and broadcast radio and television stations require equipment that can transmit their signals. This equipment usually must be up high enough that signals can get through. They are also regulated by federal law. AM and FM radio and VHF and UHF television transmission towers are considered major communication utilities. Minor communication facilities are generally smaller and include such things as personal wireless service and cellular communication facilities.

GOAL

- LU G4** Provide opportunities for locating radio and television broadcast utilities (major communications utilities) to support continued and improved service to the public and to address potential impacts to public health.

POLICIES

- LU 4.1** Allow major communications utilities only where impacts of their size and appearance can be offset, and in a way that does not lead to an overall increase in TV and radio towers.
- LU 4.2** Encourage replacing existing antennas with new antennas to achieve lower levels of radio-frequency radiation at ground level.
- LU 4.3** Prohibit new major communication utilities, such as radio and television transmission towers, in single-family and multifamily residential zones and in pedestrian-oriented commercial/mixed-use zones, and encourage existing major communication utilities to relocate to nonresidential areas.
- LU 4.4** Require major communication utilities to be developed in ways that limit impacts on nearby areas, including through development standards and design treatments that minimize visual impacts on neighboring properties and provide an overall appearance that is as compatible as possible with the uses permitted in the zone and the desired character of the area.
- LU 4.5** Limit the intrusiveness minor communication utilities could impose on communities by encouraging colocation of facilities and by requiring mitigation of visual and noise impacts.

General Development Standards

Discussion

Development standards are the rules that define what type of structure can be built on a property. Standards often include limits on building height, setbacks from the sidewalk, how much of the lot can be covered by structures, or the characteristics of the front facade of the building. Development standards help shape the look and feel of Seattle's neighborhoods as they grow. They help new buildings fit in with the character of a neighborhood or may reflect the future vision for a certain area. The standards also help builders care for the environment and take into account the physical limits of certain areas.

GOAL

- LU G5** Establish development standards that guide building design to serve each zone's function and produce the scale and character desired, while addressing public health, safety, and welfare.

POLICIES

- LU 5.1** Allow for flexibility in development standards so existing structures can be maintained and improved, and new development can better respond to site-specific conditions.
- LU 5.2** Develop and apply appropriate development standards that provide predictability regarding the allowed intensity of development and expected development types for each zone.
- LU 5.3** Control the massing of structures to make them compatible with the area's planned scale, provide a reasonable ratio of open to occupied space on a site, and allow the building to receive adequate natural light.
- LU 5.4** Use maximum height limits to maintain the desired scale relationship between new structures, existing development, and the street environment; address varied topographic conditions; and limit public view blockage. In certain Downtown zones and in industrial zones, heights for certain types of development uniquely suited to those zones may be unlimited.
- LU 5.5** Provide for residents' recreational needs on development sites by establishing standards for private or shared amenity areas such as rooftop decks, balconies, ground-level open spaces, or enclosed spaces.
- LU 5.6** Establish setbacks in residential areas as needed to allow for adequate light, air, and ground-level open space; help provide privacy; promote compatibility with the existing development pattern; and separate residential uses from more intensive uses.

- LU 5.7** Employ development standards in residential zones that address the use of the ground level of new development sites to fit with existing patterns of landscaping, especially front yards in single-family residential areas, and to encourage permeable surfaces and vegetation.
- LU 5.8** Use landscaping requirements and other tools to limit impacts on the natural environment, including increasing stormwater infiltration where appropriate.
- LU 5.9** Enhance the visual quality of an area through standards for screening and landscaping appropriate to each zone in order to limit the visual impact of new development on the surrounding neighborhood, the streetscape, and development in areas with less intensive zoning.
- LU 5.10** Regulate signage to encourage reasonable identification of businesses and to communicate information of community interest while limiting visual clutter, protecting the public interest, and enhancing the city's appearance and safety.
- LU 5.11** Establish maximum permitted noise levels that account for both the function of the noise-producing area and the function of areas where the noise may be heard in order to reduce the health hazards and nuisance factors associated with some uses.
- LU 5.12** Identify uses as major noise generators based on the noise associated with certain equipment operations or the nature of a particular activity, and regulate these uses to reduce noise to acceptable levels.
- LU 5.13** Regulate activities that generate air emissions such as dust, smoke, solvent fumes, or odors, in order to maintain and encourage successful commercial and industrial activities while protecting employees, clients, nearby residents, the general public, and the natural environment from the potential impacts.
- LU 5.14** Establish controls on the placement, direction, and maximum height of lighting and on the glare from reflective materials used on the exterior of structures in order to limit impacts on surrounding uses, enhance the character of the city, and encourage energy conservation.
- LU 5.15** Address view protection through
- zoning that considers views, with special emphasis on shoreline views;
 - development standards that help to reduce impacts on views, including height, bulk, scale, and view corridor provisions, as well as design review guidelines; and
 - environmental policies that protect specified public views, including views of mountains, major bodies of water, designated landmarks, and the Downtown skyline.
- LU 5.16** Require higher-density development to offset its impacts through mechanisms such as incentives for landmark preservation, open space amenities, and affordable housing.
- LU 5.17** Help preserve active farms in the region through strategies such as offering incentives to developers who transfer development rights from regional farmland to sites in the city.

LU 5.18 Seek excellence in new development through a design review process that encourages multiple perspectives on design issues and that complements development regulations, allowing for flexibility in the application of development standards to achieve quality design that

- enhances the character of the city;
- respects the surrounding neighborhood context, including historic resources;
- enhances and protects the natural environment;
- allows for variety and creativity in building design and site planning;
- furthers community design and development objectives;
- achieves desired intensities of development; and
- responds to the increasingly diverse social and cultural character of the city.

Off-Street Parking

Discussion

Parking is found on both public and private property. Since on-street parking can limit the cars, transit, and bicycles using the same space for travel, street parking policies are covered in the **Transportation** element. The Land Use Code regulates off-street parking, spaces often provided as part of private developments. Because the City encourages walking, biking, and transit for moving around town, consistent with the urban village strategy, the City's zoning rules do not require parking in certain areas. In urban centers and those urban villages with reliable transit access, the City instead allows the developers to decide how much parking they need to serve their tenants. In other areas, like Downtown Seattle, the City may set a limit on private parking to lessen traffic and encourage people to walk, bus, or bike to the area. Where parking is required, we know that the number of spaces, their design, and their location on the property make a big difference. Parking facilities change the size of new developments, what they look like, and what they cost to build. The policies in this section are meant to encourage communities where people can walk to what they need, especially in the urban centers and villages. They also support moving away from car-focused transportation.

GOAL

LU G6 Regulate off-street parking to address parking demand in ways that reduce reliance on automobiles, lower construction costs, create attractive and walkable environments, and promote economic development throughout the city.

POLICIES

LU 6.1 Establish parking requirements where appropriate for both single-occupant vehicles and their alternatives at levels that further this Plan's goal to increase the use of

public transit, car pools, walking, and bicycles as alternatives to the use of single-occupant vehicles.

- LU 6.2** Modify residential parking regulations, where parking is required, to recognize differences in the likely auto use and ownership of intended occupants of new developments, such as projects provided for low-income, elderly, or disabled residents.
- LU 6.3** Rely on market forces to determine the amount of parking provided in areas of the city that are well-served by transit, such as urban centers and urban villages.
- LU 6.4** Consider setting parking maximums in urban centers and urban villages, where high levels of pedestrian, bicycle, and transit accessibility make many trips possible without a car.
- LU 6.5** Establish bicycle parking requirements to encourage bicycle ownership and use.
- LU 6.6** Limit the off-street impacts on pedestrians and surrounding areas by restricting the number and size of automobile curb cuts, and by generally requiring alley access to parking when there is an accessible, surfaced alley that is not used primarily for loading and when not prevented by topography.
- LU 6.7** Prohibit most street-level parking between buildings and the street in multifamily zones and pedestrian-oriented commercial zones in order to maintain an attractive and safe street-level environment, facilitate the movement of pedestrian and vehicular traffic, minimize adverse impacts on nearby areas and structures, and, where appropriate, maintain or create continuous street fronts.
- LU 6.8** Allow shared off-site parking facilities for more efficient use of parking and to provide the flexibility to develop parking on a site separate from the development site. Ensure that such parking is compatible with the existing or desired character of the area.
- LU 6.9** Require parking in areas with limited transit access and set the requirements to discourage underused parking facilities, even if occasional spillover parking could result.
- LU 6.10** Allow parking management provisions in select commercial and multifamily residential areas to include measures such as cooperative parking, shared parking, shared vehicles, restricted access, car pools, van pools, or transit pass subsidies.
- LU 6.11** Achieve greater parking efficiency by allowing fewer parking spaces per business when several businesses share customer parking, thereby enabling customers to park once and walk to numerous businesses.
- LU 6.12** Locate off-street parking facilities to minimize impacts on the pedestrian environment, especially in areas designated for active pedestrian use.
- LU 6.13** Limit parking in City parks to discourage auto use and to limit the use of parkland for parking private cars; where parking is needed, design parking facilities in ways that preserve open space, green space, and trees and other mature vegetation.
- LU 6.14** Prohibit principal-use parking in places where that parking would be incompatible with the area's intended function.

LU 6.15 Discourage the development of major stand-alone park-and-ride facilities within Seattle. Additions to park-and-ride capacity could be considered

- at the terminus of a major regional transit system,
- where opportunities exist for shared parking, or
- where alternatives to automobile use are particularly inadequate or cannot be provided in a cost-effective manner.

Land Use Areas

Discussion

Historically, zones were created so that different types of uses could be developed only in distinct areas of the city. One reason for this was to keep the uses in one area from affecting the uses in another in a negative way. For example, industrial activities like manufacturing were separated from residential areas to protect residents from harm. Over time, the city evolved in a pattern similar to that basic idea. There are still areas in the city that have distinct uses, but over time commercial uses and residential uses began to blend more to give people better access to shops and services. These changing patterns helped give Seattle its unique neighborhoods. For instance, areas with commercial zoning that allows shops and small offices have become the heart of many neighborhoods.

Areas that already had business cores and multifamily housing and that are zoned for more housing and businesses have become the cores of the urban villages. Some single-family areas in the city were developed at different times, giving them distinct characteristics that show their history. For instance, houses might have a similar architectural style or have a similar relationship to their surroundings.

Each of the land use areas plays a unique role in the city. Used in combination, they help Seattle grow in ways that meet the city's needs. They allow us to place new housing in the areas where the most jobs and services are or will be in the future. They also allow us to encourage housing in places that already have frequent and reliable transit service or that will have better access as improvements and investments are made in rail or bus service.

Single-Family Residential Areas

Single-family zones cover much of the city. While they are thought of as residential neighborhoods, they include a variety of uses beyond housing. For instance, most of the public parkland is found in these zones, as are many of the public schools, cemeteries, and fire stations. In most of these areas, houses are usually not very tall and typically have yards and

open space around them. That open space provides recreation opportunities for residents and land for much of the city's tree canopy.

Much of the land in these areas has been built to the densities the current zoning rules allow. However, some different housing types, such as accessory dwelling units or backyard cottages, could increase the opportunity for adding new housing units in these areas. Over time, some single-family areas could be incorporated into nearby urban villages, and there could be a new definition of what is allowable in these zones when they are inside urban villages.

GOAL

LU G7 Provide opportunities for detached single-family and other compatible housing options that have low height, bulk, and scale in order to serve a broad array of households and incomes and to maintain an intensity of development that is appropriate for areas with limited access to services, infrastructure constraints, fragile environmental conditions, or that are otherwise not conducive to more intensive development.

POLICIES

LU 7.1 Designate as single-family residential areas those portions of the city that are predominantly developed with single-family houses and that are large enough to maintain a consistent residential character of low height, bulk, and scale over several blocks.

LU 7.2 Use a range of single-family zones to

- maintain the current low-height and low-bulk character of designated single-family areas;
- protect designated single-family areas that are predominantly in single-family residential use or that have environmental or infrastructure constraints;
- allow different densities that reflect historical development patterns; and
- respond to neighborhood plans calling for redevelopment or infill development that maintains the single-family character of the area but also allows for a greater range of housing types.

LU 7.3 Consider allowing redevelopment or infill development of single-family areas inside urban centers and villages, where new development would maintain the low height and bulk that characterize the single-family area, while allowing a wider range of housing types.

LU 7.4 Allow detached single-family dwellings as the principal use permitted outright in single-family residential areas.

- LU 7.5** Encourage accessory dwelling units and other housing types that are attractive and affordable to a broad range of households and incomes and that are compatible with the development pattern and building scale in single-family areas.
- LU 7.6** Limit the number and types of nonresidential uses allowed in single-family residential areas and apply appropriate development standards in order to protect those areas from the negative impacts of incompatible uses.
- LU 7.7** Prohibit parking lots or other activities that are part of permitted uses in neighboring higher-intensity zones from locating or expanding in single-family residential areas.
- LU 7.8** Use minimum lot size requirements to maintain the character of single-family residential areas and to reflect the differences in environmental and development conditions and densities found in various single-family areas throughout the city.
- LU 7.9** Allow exceptions to minimum lot size requirements to recognize building sites created under earlier regulations and historical platting patterns, to allow the consolidation of very small lots into larger lots, to adjust lot lines to permit more orderly development patterns, and to provide more housing opportunities by creating additional buildable sites that integrate well with surrounding lots and do not result in the demolition of existing housing.
- LU 7.10** Reflect the character of existing low-density development through the regulation of scale, siting, structure orientation, and setbacks.
- LU 7.11** Permit, through Council or administrative conditional use approval, variations from established standards for planned large developments in single-family areas, to promote high-quality design that
- is compatible with the character of the area,
 - enhances and preserves natural features and functions,
 - encourages the construction of affordable housing,
 - allows for development and design flexibility, and
 - protects environmentally critical areas.
- Such developments should not be considered as sole evidence of changed circumstances to justify future rezones of the site or adjacent properties.
- LU 7.12** Emphasize measures that can increase housing choices for low-income individuals and families when considering changes to development standards in single-family areas.

Multifamily Residential Areas

Discussion

The city's multifamily areas contain a variety of housing types. You might find duplexes or town houses, walk-up apartments or highrise towers. These structures may include units that are owned by the residents or may provide rental housing. Overall, these areas offer

more choices for people with different living styles and a wider range of incomes than single-family zones.

GOAL

- LU G8** Allow a variety of housing types and densities that is suitable for a wide range of households and income levels, including opportunities for both homeownership and renting, and that promotes walking and transit use near employment concentrations, residential services, and amenities.

POLICIES

- LU 8.1** Designate as multifamily residential areas those places that either are predominantly occupied by multifamily development or are within urban centers or urban villages.
- LU 8.2** Maintain a variety of multifamily zoning classifications that allow development at different densities, scales, and configurations and that are well suited to the variety of specific conditions and development goals in diverse areas of the city.
- LU 8.3** Provide housing for Seattleites at all income levels in development that is compatible with the desired neighborhood character and that contributes to high-quality, livable urban neighborhoods.
- LU 8.4** Establish evaluation criteria for rezoning land to multifamily designations that support the urban village strategy, create desirable multifamily residential neighborhoods, maintain compatible scale, respect views, enhance the streetscape and pedestrian environment, and achieve an efficient use of the land without major impact on the natural environment.
- LU 8.5** Allow multifamily areas to be reclassified to compatible pedestrian-friendly commercial/mixed-use areas, when such action is consistent with the urban village strategy or approved in an adopted neighborhood plan.
- LU 8.6** Establish multifamily residential use as the predominant use in multifamily areas and limit the number and type of nonresidential uses to preserve the residential character of these areas, protect these areas from negative impacts of incompatible uses, and maintain development opportunities for residential use.
- LU 8.7** Encourage multifamily developments with units that have direct access to residential amenities, such as ground-level open space, to increase their appeal for families with children.
- LU 8.8** Allow a variety of attached housing types to accommodate a wide diversity of households in multifamily zones.
- LU 8.9** Establish lowrise multifamily zones to accommodate various housing choices in the low- to moderate-density range, including walk-up apartments, town houses, row houses, duplexes, triplexes, and cottage housing.

- LU 8.10** Designate lowrise multifamily zones in places where low-scale buildings can provide a gradual transition between single-family zones and more intensive multifamily or commercial areas.
- LU 8.11** Use midrise multifamily zones to provide greater concentrations of housing in urban villages and urban centers.
- LU 8.12** Emphasize residential character in the development standards for midrise multifamily zones and allow for scale and building types that differ from those in less intensive residential areas to accommodate a greater density of development to support nearby businesses.
- LU 8.13** Use highrise multifamily zoning designations only in urban centers, where the mix of activities offers convenient access to regional transit and to a full range of residential services and amenities, as well as to jobs.
- LU 8.14** Ensure that midrise and highrise development balances the desire to accommodate larger-scale, high-density development with the need to maintain livability through controls on such impacts as shadows, bulk, open space, and traffic.
- LU 8.15** Permit street-level commercial uses in midrise and highrise neighborhoods to allow residents greater access to services and to promote an active street environment without detracting from the overall residential character desired for high-density neighborhoods.

Commercial/Mixed-Use Areas

Discussion

Commercial/mixed-use zones are places meant to provide jobs and services. Most of these zones also allow housing. Since 2005, almost two-thirds of new housing units in the city have been built in these zones. Housing might be built as a stand-alone structure or along with commercial space. Mixed-use areas or projects contain residential and commercial uses. Mixed-use projects often have offices or stores on the ground floor with housing above.

The Land Use Code identifies several different types of commercial zones. These zones provide flexibility to developers and are meant to create communities with a variety of activities. Structures in these zones can be built to different heights depending on where they are located. The general commercial zones tend to be found on major arterials and are more auto-oriented. Neighborhood Commercial and Seattle Mixed zones use development standards that produce more walkable environments and are better for housing development.

GOAL

- LU G9** Create and maintain successful commercial/mixed-use areas that provide a focus for the surrounding neighborhood and that encourage new businesses, provide stability and expansion opportunities for existing businesses, and promote neighborhood vitality, while also accommodating residential development in livable environments.

POLICIES

- LU 9.1** Prioritize the preservation, improvement, and expansion of existing commercial/mixed-use areas over the creation of new business districts in order to strengthen the existing areas.
- LU 9.2** Encourage the development of compact, concentrated commercial/mixed-use areas, in urban centers and urban villages, where pedestrians can easily access transit and a variety of businesses.
- LU 9.3** Provide a range of commercial-zone classifications to allow different mixes and intensities of activity, varying scales of development, varying degrees of residential or commercial orientation, and varying degrees of pedestrian or auto orientation.
- LU 9.4** Apply development standards that distinguish between pedestrian-oriented commercial zones, which are compatible with and easily accessible from their surrounding neighborhoods, and general commercial zones, which accommodate uses that are more dependent on automobile access.
- LU 9.5** Support a wide range of uses in commercial areas, taking into account the intended pedestrian, automobile, or residential orientation of the area, the area's role in the urban village strategy, and the impacts that the uses could have on surrounding areas.
- LU 9.6** Encourage housing in mixed-use developments in pedestrian-oriented commercial/mixed-use areas to provide additional opportunities for residents to live in neighborhoods where they can walk to transit, services, and employment.
- LU 9.7** Apply limits on the size of specific uses in commercial areas when those limits would
- help ensure that the scale of uses is compatible with the character and function of the commercial area;
 - discourage uses likely to attract significant vehicular traffic from locating in pedestrian-oriented commercial areas;
 - promote compatible land use and transportation patterns;
 - foster healthy commercial development; or
 - provide opportunities for small local businesses to locate, especially in ethnically relevant business districts throughout the city.
- LU 9.8** Limit the creation or expansion of uses that generate high volumes of vehicle traffic by reviewing proposals for such uses in order to control the associated

traffic impacts and ensure that the uses are compatible with the character of the commercial area and its surroundings.

- LU 9.9** Limit new drive-in businesses and accessory drive-in facilities in pedestrian-oriented commercial/mixed-use areas and in other locations by using development standards that address the potential for traffic impacts, pedestrian/vehicle conflicts, and disruption of an area's business frontage, as well as the overall appearance of the commercial area.
- LU 9.10** Prohibit or limit the location and size of outdoor uses and activities in certain commercial areas, according to the area's function and its proximity to residentially zoned lots, in order to maintain and improve the continuity of the commercial street front, reduce the visual and noise impacts associated with such outdoor activities, and remain compatible with adjacent residential areas.
- LU 9.11** Preserve active streetscapes in pedestrian-oriented commercial/mixed-use areas by limiting residential uses along the street frontage of the ground floor and by keeping those spaces available primarily for commercial uses and other uses that help activate the street, in order to strengthen business districts.
- LU 9.12** Consider allowing street-level residential uses outside pedestrian-oriented areas and, when street-level residential uses are permitted, identify ways to give ground-floor tenants privacy and to create visual interest along the street front.
- LU 9.13** Provide amenity areas for use by residents of housing in commercial/mixed-use areas.
- LU 9.14** Assign height limits to commercial/mixed-use areas independent of the commercial zone designations but consistent with the intended intensity of development in the zone. Allow different areas within a zone to be assigned different height limits based on the need to
- further the urban village strategy's goals of focusing growth in urban villages,
 - accommodate the desired functions and intensity of development,
 - provide a compatible scale relationship with existing zoning in the vicinity,
 - accommodate desired transitions with development in adjacent areas, and
 - consider potential view blockage.
- LU 9.15** Allow limited exceptions to the height limit in order to accommodate ground-floor commercial uses or special rooftop features, encourage development of mixed-use structures, enable structures to function appropriately, accommodate special features consistent with the special character or function of an area, or support innovative design that furthers the goals of this Plan.
- LU 9.16** Apply appropriate development standards to promote compatible conditions along the edges of commercial zones abutting residential zones.
- LU 9.17** Use a development pattern, mix of uses, and intensity of activity generally oriented to pedestrian and transit use in pedestrian-oriented commercial/mixed-use zones to achieve
- a compatible blend of commercial and residential uses;

- strong, healthy business districts that reinforce a sense of place while providing essential goods, services, and livelihoods for Seattleites, especially residents who are within walking distance of these places;
- mixes of commercial activity that are compatible with development in adjacent areas;
- residential development that is both appealing to residents and compatible with the desired commercial function of the area; and
- an active, attractive, accessible, walkable pedestrian environment with continuous commercial street frontages.

LU 9.18 Apply pedestrian-oriented commercial zones in places where residential uses are in close proximity and where the allowed development intensity conforms in size and scale to the community it serves.

LU 9.19 Locate and provide access to accessory parking facilities in pedestrian-oriented commercial zones in ways that avoid conflicts with pedestrian routes and interruptions to the continuity of the street facade, such as by locating unenclosed parking to the side of or behind the building, or by enclosing parking below the building or within the building and screening it from the street, preferably by other uses.

LU 9.20 Use general commercial zones to support existing auto-oriented commercial areas that serve a citywide or regional clientele and have easy access to principal arterials, or in areas that border industrial zones, where they can help to maintain compatible development conditions.

LU 9.21 Encourage the conversion of general commercial areas within urban villages to pedestrian-oriented commercial zones, in keeping with this Plan's goals for pedestrian-oriented environments within the urban villages.

LU 9.22 Accommodate the broadest range of commercial activities in general commercial areas, including retail uses of all sizes, small office buildings, warehouses, and light and general manufacturing facilities.

LU 9.23 Use zoning and other planning tools in urban centers and urban villages to address displacement of businesses that provide culturally relevant goods and services to Seattle's diverse population.

Industrial Areas

Discussion

Seattle has a long history as the main shipping, manufacturing, and freight-distribution center for the region. These days, those activities take place mostly in industrial zones located in the city's two manufacturing/industrial centers. These industrial areas are large and

generally flat. In these areas, City zoning rules allow industrial activity such as manufacturing, warehousing, and shipping of goods through waterways, railways, and highways.

Industrial zones are an important source of living wage jobs and make the local economic base more stable. Having industrial activity in the city makes Seattle less vulnerable to shifts in the economy. Due to the volume of truck traffic, the need some industrial businesses have for access to rail service, and the large sites that many of those businesses need, it is important to provide large, separate areas for these activities.

GOAL

LU G10 Provide sufficient land with the necessary characteristics to allow industrial activity to thrive in Seattle and protect the preferred industrial function of these areas from activities that could disrupt or displace them.

POLICIES

LU 10.1 Designate industrial zones generally where

- the primary functions are industrial activity and industrial-related commercial functions,
- the basic infrastructure needed to support industrial uses already exists,
- areas are large enough to allow a full range of industrial activities to function successfully, and
- sufficient separation or special conditions exist to reduce the possibility of conflicts with development in adjacent less intensive areas.

LU 10.2 Preserve industrial land for industrial uses, especially where industrial land is near rail- or water-transportation facilities, in order to allow marine- and rail-related industries that rely on that transportation infrastructure to continue to function in the city.

LU 10.3 Accommodate the expansion of current industrial businesses and promote opportunities for new industrial businesses within Seattle to strengthen the city's existing industrial economy.

LU 10.4 Restrict to appropriate locations within industrial areas those activities that—by the nature of materials involved or processes employed—are potentially dangerous or very noxious.

LU 10.5 Provide a range of industrial zones that address varying conditions and priorities in different industrial areas. Those priorities include maintaining industrial areas that have critical supporting infrastructure, providing transitions between industrial areas and less intensive areas, and promoting high-quality environments attractive to business expansion or to new industrial activities.

- LU 10.6** Prohibit new residential development in industrial zones, except for certain types of dwellings, such as caretaker units, that are related to the industrial area and that would not restrict or disrupt industrial activity.
- LU 10.7** Use the general industrial zones to promote a full range of industrial activities and related support uses.
- LU 10.8** Apply the general industrial zones mostly within the designated manufacturing/ industrial centers, where impacts from industrial activity are less likely to affect residential or commercial uses. Outside of manufacturing/industrial centers, general industrial zones may be appropriate along waterways used for maritime uses.
- LU 10.9** Avoid placing industrial zones within urban centers or urban villages. However, in locations where a center or village borders a manufacturing/industrial center, use of the industrial commercial zone within the center or village where it abuts the manufacturing/industrial center may provide an appropriate transition to help separate residential uses from heavier industrial activities.
- LU 10.10** Limit the density of development for nonindustrial uses in the manufacturing/ industrial centers to reduce competition from nonindustrial activities that are better suited to other locations in the city, particularly urban centers and urban villages, where this Plan encourages most new residential and commercial development. Permit commercial uses in industrial areas only if they reinforce the industrial character, and strictly limit the size of office and retail uses not associated with industrial uses, in order to preserve these areas for industrial development.
- LU 10.11** Recognize the unique working character of industrial areas by keeping landscaping and street standards to a minimum to allow flexibility for industrial activities, except along selected arterials where installing street trees and providing screening and landscaping can offset impacts of new industrial development in highly visible locations.
- LU 10.12** Set parking and loading requirements in industrial zones to provide adequate parking and loading facilities to support business activity, promote air quality, encourage efficient use of the land in industrial areas, discourage underused parking facilities, and maintain adequate traffic safety and circulation. Allow some on-street loading and occasional spillover parking.
- LU 10.13** Maintain standards for the size and location of vehicle curb cuts and driveways in industrial zones in order to balance the need to provide adequate maneuvering and loading areas with availability of on-street parking and safe pedestrian access.
- LU 10.14** Permit noise levels in industrial areas, except buffer areas, that would not be allowed in other parts of the city, in recognition of the importance and special nature of industrial activities.
- LU 10.15** Classify certain industrial activities as conditional uses in industrial zones in order to accommodate these uses while making sure they are compatible with the zone's primary industrial function and to protect public safety and welfare on nearby sites. Require mitigation of impacts on industrial activity and on the immediate surroundings, especially nearby less intensive zones.

- LU 10.16** Prohibit uses that attract large numbers of people to the industrial area for nonindustrial purposes, in order to keep the focus on industrial activity and to minimize potential conflicts from the noise, nighttime activity, and truck movement that accompanies industrial activity.
- LU 10.17** Establish the industrial buffer zone to provide an appropriate transition between industrial areas and adjacent residential or pedestrian-oriented commercial zones.
- LU 10.18** Allow the widest possible range of manufacturing uses and related industrial and commercial activities within the industrial buffer zone, while ensuring compatibility with the activity and physical character of neighboring less intensive zones.
- LU 10.19** Include development standards or performance standards for the industrial buffer zone that protect the livability of neighboring areas, promote visual quality, and maintain a compatible scale of development along zone edges. Apply these standards only in places where existing conditions do not adequately separate industrial activity from less intensive zones.
- LU 10.20** Limit the height of structures on the borders of industrial buffer zones where streets along the zone edge do not provide sufficient separation for a reasonable transition in scale between industrial areas and less intensive neighboring zones, taking into consideration the permitted height in the abutting less intensive zone.
- LU 10.21** Allow a wide mix of employment activities in the industrial commercial zones, such as light manufacturing and research and development.
- LU 10.22** Limit development density in industrial commercial zones in order to reflect transportation and other infrastructure constraints, while taking into account other features of an area.
- LU 10.23** Include development standards in the industrial commercial zone designed to create environments that are attractive to new technology businesses and that support a pedestrian-oriented environment, while controlling structure height and scale to limit impacts on nearby neighborhoods.
- LU 10.24** Provide a range of maximum building height limits in the industrial commercial zones in order to protect the distinctive features that attract new technology businesses to the area—such as views of water, shoreline access, and the neighborhood scale and character—to make sure that these features will continue to be enjoyed, both within the zone and from the surrounding area.
- LU 10.25** Assign height limits independently of the industrial zoning designation to provide flexibility in zoning-specific areas and to allow different areas within a zone to be assigned different height limits according to the rezone criteria.

Downtown Areas

Discussion

Downtown is the most densely developed area in the Pacific Northwest. It includes five distinct neighborhoods: Belltown, Denny Triangle, the Commercial Core, Pioneer Square, and Chinatown/International District. Because each of these neighborhoods has a unique character, the City has a different plan for how each is expected to grow. This makes regulations for development in Downtown very detailed and complex. For this reason, the guidance for Downtown regulations is not found in this element. Instead, it can be found as part of the Downtown Urban Center Neighborhood Plan, located in the **Neighborhood Plans** volume of this Plan.

GOAL

- LU G11** Promote Downtown Seattle as an urban center with the densest mix of residential and commercial development in the region, with a vital and attractive environment that supports employment and residential activities and is inviting to visitors.

POLICIES

- LU 11.1** Recognize the distinct areas of Downtown that are defined by their histories and by their primary land use function, such as office, retail, or mixed-use with either a commercial or a residential emphasis.
- LU 11.2** Use a range of land use zones and height limits to support the existing and desired character of different areas within Downtown.

Location-Specific Regulations

Discussion

In certain places in the city, different sets of rules “overlay” the zoning regulations. These overlays take into account a special use or characteristic of the area. For example, historic districts each have a separate set of regulations that preserve the area’s unique historic features. The policies in this section guide how the City adjusts its regulations to the special functions and needs of major institutions, historic districts and landmarks, and environmentally critical areas. These policies generally describe overlays that could be applied in several places within the city. In addition to the areas covered in this section, the Land Use Code contains regulations governing specific overlay districts that apply only in certain locations,

such as major institution overlays or the Pike/Pine corridor. There is also an overlay that applies to the shorelines along major water bodies in the city. Policies for that overlay can be found in the Shoreline Areas element of this Plan.

GOAL

- LU G12** Provide flexibility in standard zone provisions or supplement those provisions to achieve special public purposes in areas where unique conditions exist, such as shorelines, historic and special review districts, and major institutions.

POLICIES

- LU 12.1** Allow for zoning overlay districts, which modify the regulations of the underlying zoning, to address special circumstances and issues of significant public interest in subareas of the city.
- LU 12.2** Establish a master planned community zone and apply the zone as a way to address unique opportunities for large site redevelopments in the densest areas of the city. Use this designation to provide predictability to the City, the community, and potential developers, with the intent to encourage a mix of uses at appropriate urban densities that use a cohesive urban design and promote high levels of environmental sustainability, housing affordability, and publicly accessible open space. Designate a master planned community only for large multiblock sites inside an urban center that are subject to unified control.
- LU 12.3** Consider establishing a master planning process for large sites outside of urban centers in order to allow development that incorporates good urban design and appropriate public benefits.
- LU 12.4** Regulate development and promote design guidelines in the stadium area transition overlay to promote an environment that is attractive and safe for the large volumes of pedestrians attending events in the area.

Major Institutions

Discussion

Hospitals, colleges, and universities deliver vital services to residents of Seattle and the Pacific Northwest. They employ one in eight Seattle workers and make the city's economy more diverse. However, they can also increase traffic and displace housing and businesses. The policies in this section help guide the City in allowing these institutions to grow, while mitigating the impacts of that growth on the livability of surrounding neighborhoods.

GOAL

- LU G13** Encourage the benefits that major institutions offer the city and the region, including health care, educational services, and significant employment opportunities, while mitigating the adverse impacts associated with their development and geographic expansion.

POLICIES

- LU 13.1** Designate the campuses of large hospitals, colleges, and universities as major institutions, making clear that they are defined under a separate public process in terms of their appropriate uses and development standards.
- LU 13.2** Support the coordinated growth of major institutions through conceptual master plans and the creation of major institution overlay districts. Use a master plan process to identify development standards for the overlay district that are specifically tailored to the major institution and the surrounding area.
- LU 13.3** Balance the need for major institutions to grow and change with the need to maintain the livability and vitality of neighboring areas.
- LU 13.4** Establish major institution overlays (MIO) as a designation on the Official Land Use Map and the Future Land Use Map to show areas where development is regulated by the contents of a master plan, rather than by the underlying zoning. Where appropriate, establish MIO boundaries for better integration between major institution areas and less intensive zones.
- LU 13.5** Encourage community involvement in the development, monitoring, implementation, and amendment of major institution master plans, including the establishment of citizens' advisory committees that include community and major institution representatives.
- LU 13.6** Allow the MIO to modify underlying zoning provisions and development standards, including use restrictions and parking requirements, in order to accommodate the changing needs of major institutions, provide development flexibility, and encourage a high-quality environment.
- LU 13.7** Discourage the expansion of established major institution boundaries.
- LU 13.8** Require either that a master plan be prepared or that the existing master plan be revised when a proposed major development that is part of a major institution does not conform to the underlying zoning and is not included in an existing master plan.
- LU 13.9** Locate new major institutions in areas where their activities are compatible with the surrounding land uses and where the impacts associated with existing and future development can be appropriately mitigated, and provide procedures for considering the establishment of new major institutions.
- LU 13.10** Define as major institution uses those that are part of, or substantively related to, the major institution's central mission or that primarily and directly serve institution users, and allow these uses within the MIO district, in accordance with the

development standards of the underlying zoning classifications or adopted master plan.

- LU 13.11** Apply the development standards of the underlying zoning classification to all major institution development, except for specific standards altered by a master plan.
- LU 13.12** Determine appropriate measures to address the need for adequate transition between the major institution and surrounding uses.
- LU 13.13** Establish minimum parking requirements in each MIO district to address the needs of the major institution and reduce parking demand in nearby areas. Include maximum parking limits to avoid unnecessary traffic in the surrounding areas and to limit the use of single-occupant vehicles. Allow an increase in the number of permitted spaces only when such an increase is needed to reduce parking demand on surrounding streets and when it will help to minimize traffic congestion in the area.
- LU 13.14** Use a transportation-management program to reduce the number of vehicle trips to the major institution and to limit the adverse impacts of traffic and of institution-related parking on surrounding streets, especially residential streets. Strive to reduce the number of single-occupant vehicles used for trips to and from major institutions at peak times. Allow short-term or long-term parking space requirements to be modified as part of a transportation-management program.
- LU 13.15** Encourage housing preservation within major institution overlay districts and limit impacts on housing in surrounding areas. Discourage conversion or demolition of housing within a major institution's campus, allowing it only when the institution needs to expand or when the institution replaces the lost housing with new housing. Prohibit the demolition of noninstitutional housing for replacement by principal-use parking that is not necessary to meet the parking requirement. Prohibit development by a major institution outside of the MIO district boundaries when it would result in the demolition or conversion of residential buildings into nonresidential uses, unless authorized by an adopted master plan.
- LU 13.16** Require a master plan whenever a major institution proposes development that could affect the livability of adjacent neighborhoods or that has the potential for significant adverse impacts on the surrounding areas. Use the master plan to
- guide a comprehensive review of potential benefits and impacts of the major institution's proposed development,
 - establish or modify geographic boundaries for the major institution and establish clear guidelines and development standards on which the major institutions and community can rely for long-term planning and development,
 - provide the neighborhood with advance notice of the institution's development plans,
 - allow the City to anticipate and plan for public capital or programmatic actions that will be needed to accommodate development,

- provide the basis for determining appropriate mitigating actions to avoid or reduce adverse impacts from major institution growth,
- establish a transportation-management program, and
- define the major institution's development program for a specified time period.

LU 13.17 Require City Council review and adoption of the master plan after the major institution, the surrounding community, and the City develop the master plan.

LU 13.18 Achieve a better relationship between residential, commercial, or industrial uses and the major institution's activities when considering rezones, while also trying to reduce or eliminate major land use conflicts.

Historic Districts and Landmarks

Discussion

Seattle values its past and recognizes and protects its heritage. One way we do this is by calling out more than 450 buildings, objects, and sites of exceptional significance, and eight historic districts. These visible connections to the past strengthen our sense of place and help build community. Finding new uses for existing structures also helps achieve the City's goals for sustainable development, because reusing historic buildings is more sustainable than demolishing and replacing them. Preserving and restoring historic buildings can encourage other revitalization in the neighborhood and attract new businesses.

GOAL

LU G14 Maintain the city's cultural identity and heritage.

POLICIES

LU 14.1 Support the designation of areas as historic and special review districts, and the designation of structures, sites, and objects as City of Seattle landmarks in order to protect, enhance, and perpetuate their historical or architectural identities.

LU 14.2 Tailor development standards and design review processes specifically for a special review district to describe design-related features allowed, encouraged, limited, or excluded from the district. Allow adopted guidelines to modify, exempt, or supersede the underlying zone's standards.

LU 14.3 Encourage the adaptive reuse of designated landmark structures by allowing uses in these structures that may not otherwise be allowed under the applicable zoning, provided such action is approved by the Landmarks Preservation Board.

- LU 14.4** Use incentives, including the transfer of development rights, to encourage property owners and developers to restore or reuse designated landmark structures and specified structures in designated districts.
- LU 14.5** Consider the use of conservation districts to recognize and sustain the character of unique residential or commercial districts.
- LU 14.6** Protect the scale and character of the established development pattern, while encouraging compatible and context-sensitive infill development.
- LU 14.7** Identify historic resources that can be successfully used to meet the city's housing goals.
- LU 14.8** Identify, preserve, and protect archaeological resources.

Environmentally Critical Areas

Discussion

While Seattle is essentially a built city, there remain many natural areas that deserve special attention and care. Taking care of these areas is important for conservation but also to prevent possible harm to other parts of the city. For example, landslides, floods, or poor water quality would affect more than just these vulnerable areas. For these reasons, the City has regulations that help protect these areas from the wrong types of use or, in some cases, from use altogether.

GOAL

- LU G15** Maintain a regulatory system that aims to
- protect the ecological functions and values of wetlands and fish and wildlife conservation areas;
 - prevent erosion on steep slopes;
 - protect public health, safety, and welfare in areas subject to landslides, liquefaction, floods, or peat settlement, while permitting reasonable development;
 - protect the public by identifying seismic and volcanic hazard areas; and
 - avoid development that causes physical harm to people, property, public resources, or the environment.

POLICIES

- LU 15.1** Use best available science to identify and protect environmentally critical areas.
- LU 15.2** Promote both public and private opportunities to improve water quality and enhance aquatic, wetland, and terrestrial habitats in the city's environmentally critical areas so that these habitats are healthy for native wildlife and people.
- LU 15.3** Regulate the design and siting of structures and land-disturbing actions associated with development projects in environmentally critical areas and buffers to protect the ecological functions and values of environmentally critical areas and their buffers and to protect public health and safety on development sites and neighboring properties.
- LU 15.4** Permit modification of development standards in environmentally critical areas and buffers to protect the ecological functions and values of the critical areas while allowing reasonable development.
- LU 15.5** Review rezones in or adjacent to an environmentally critical area or a hazard-prone area by considering the effects on the ecological functions and values of the critical area and on public health, safety, and welfare, and recognize that lower-intensity zones and uses are generally more appropriate than higher-intensity zones in these areas. Review subdivisions and lot-boundary adjustments in or adjacent to wetlands, fish and wildlife habitat conservation areas, steep slope-erosion areas, and other environmentally critical areas by considering the effects on the ecological functions and values of those critical areas.
- LU 15.6** Adopt regulations that encourage landowners and developers to voluntarily enhance the ecological functions and values of environmentally critical areas.
- LU 15.7** Provide opportunities for environmental education associated with environmentally critical areas.
- LU 15.8** Regulate development on landslide-prone hillsides to protect against future damage due to instability that might be created or exacerbated by development, including potential damage to public facilities. Consider the relative risk to life or property when reviewing development proposals for landslide-prone areas.
- LU 15.9** Require engineering solutions for development in landslide-prone areas to provide complete stabilization of the developed area.
- LU 15.10** Limit disturbance and maintain and enhance vegetative cover on steep slopes to control erosion and water runoff in order to reduce the risk of siltation and other environmental impacts to streams, lakes, Puget Sound, and the City's stormwater facilities.
- LU 15.11** Require new development in liquefaction-prone areas to be designed and built to limit property damage and to reduce risks of injury and loss of life during earthquakes.
- LU 15.12** Regulate development on abandoned solid-waste landfill sites and areas within a thousand feet of those sites to reduce the risks of ground subsidence, earthquake-induced ground shaking, and methane-gas accumulation.

- LU 15.13** Regulate development in peat settlement-prone areas to limit ground settlement caused by the removal of groundwater and by structural and earth-fill loads on those areas and nearby parcels.
- LU 15.14** Seek a net gain in wetland function by enhancing and restoring wetland functions across the city in City projects.
- LU 15.15** Support efforts to restore wetlands to their original state and natural function.
- LU 15.16** Protect Seattle's unique remaining wetland resources and use mitigation sequencing to address construction and postconstruction impacts in wetlands and their buffers by strictly regulating development.
- LU 15.17** Seek to avoid a net loss in area of wetland acreage, and require no net loss of wetland functions and values when development is allowed; functions and values include but are not limited to flood control, water quantity and quality, and fish and wildlife habitat.
- LU 15.18** Protect existing vegetation in wetlands and their buffers, unless augmenting or replanting can be shown to better protect the wetland's functions and values.
- LU 15.19** Regulate development in and near designated fish- and wildlife-habitat conservation areas in order to protect the remaining native wildlife species and significant fish populations, especially salmonids.
- LU 15.20** Regulate development in environmentally critical areas that contain vegetative cover and physical space for habitat, and seek to
- protect contiguous wildlife-habitat areas;
 - maintain wildlife corridors that connect functions;
 - conserve soil and ground conditions that support native vegetation;
 - prevent siltation and high water temperatures in downstream habitats;
 - dampen fluctuations in surface-water flows, which are typically problematic in urbanized areas; and
 - maintain groundwater recharge flow to support stream flows during drier seasons.
- LU 15.21** Establish riparian corridors that include the water course or water body and riparian management area.
- LU 15.22** Limit development within the riparian corridor to protect the natural functions and values of these areas from the potential negative effects of urban development. Retain vegetation in its natural condition. If the vegetation within the riparian corridor is degraded, allow new native plantings that enhance the functions and values of the riparian corridor.
- LU 15.23** Establish development standards to protect existing water quality, prevent erosion and siltation, and protect fish and wildlife habitats.

- LU 15.24** Establish an area bordering adjacent bodies of water on every development site, strictly limit development within such areas, and leave vegetation in its natural condition unless new plantings will enhance the functions of the buffer.
- LU 15.25** Regulate development in flood-prone areas in order to protect public health and safety, and aquatic habitat, and to prevent damage to private property caused by hazardous flooding conditions.
- LU 15.26** Consider retaining City-owned properties that are in environmentally critical areas as natural areas.

Transportation



Introduction

The Transportation element guides transportation investments to equitably serve the city's current residents and businesses and to accommodate Seattle's future growth. Hundreds of thousands of city and regional residents and businesses depend on the city's transportation system to access jobs, services, and community facilities, and to deliver freight and goods. Thousands more people will depend on it in the next twenty years as the city and region continue to grow. In Seattle's future, a robust transportation system should

- *contribute to a safer city by working to eliminate serious injuries and fatalities on city streets;*
- *create an interconnected city where people have reliable, easy-to-use travel options;*
- *develop a more vibrant city by creating streets and sidewalks that generate economic and social activity, adding to the city's overall health, prosperity, and happiness; and*

- *contribute to a more affordable city by providing high-quality and affordable transportation options that allow people to spend money on other things.*

Seattle's transportation system in 2035 will look very different than it does now. For example, the Alaskan Way Viaduct will be gone, and State Route 99 will go through a tunnel in central Seattle. Light rail transit, streetcar routes, and frequent bus networks will be much more extensive, with light rail extending through more of the city and providing connections to Bellevue, Redmond, Shoreline, and Lynnwood. New technological innovations in transportation such as smart parking, shared transportation options (such as bike share and car share services, whose customers do not own the vehicles they use), and driverless vehicles will change the way people move through Seattle. This Plan will guide the City's future actions to address these and other changes.

As a mature, fully built city, Seattle already has a core network of streets. There is no room for major new streets, which creates challenges but also opportunities as the City plans for growth. Making arterial streets wider is unfeasible and undesirable from a cost and environmental standpoint. It would also run counter to the City's goal to cut greenhouse gas emissions. Therefore, we must use the streets and sidewalks we have in the most efficient way possible. This means prioritizing street space so that it can be used by the most people, at most times of the day, and in a variety of ways. While many people still rely on a personal car as their best or only transportation option, the City plans to make travel more efficient and predictable for all by offering high-quality travel options. Improved mobility in the future will also require looking for opportunities to remove or reduce choke points such as railroad crossings and to use new traffic-signal timing and other technologies to help move people and goods.

The **Transportation Appendix** contains inventories of transportation facilities and an analysis of the transportation effects of this Plan's growth strategy.

Integrating Land Use and Transportation

Discussion

The development pattern described in the Growth Strategy and Land Use elements of this Plan has a major influence on the City's transportation system. The City's growth strategy focuses growth in urban centers, urban villages, and manufacturing/industrial centers. Crucial to the success of these areas is reliable transportation to, from, and within these areas. This will require a transportation system that includes several methods of travel for all trips throughout the day, including during the evening and on weekends. Automobile and freight access to property will remain important for accommodating growth throughout the city.

The City can make improvements to better connect people to urban centers and urban villages by many travel options, especially by transit and bicycle. In addition, transportation facilities that connect to and support the city’s two manufacturing/industrial centers are very important to the city’s economy. Seattle must find the right balance between serving the areas that will see the most growth and providing transportation services to all who need it, including those in parts of Seattle that have historically seen less investment in transportation.

GOAL

TG 1 Ensure that transportation decisions, strategies, and investments support the City’s overall growth strategy and are coordinated with this Plan’s land use goals.

POLICIES

- T 1.1** Provide safe and reliable transportation facilities and services to promote and accommodate the growth this Plan anticipates in urban centers, urban villages, and manufacturing/industrial centers.
- T 1.2** Improve transportation connections to urban centers and villages from all Seattle neighborhoods, particularly by providing a variety of affordable travel options (pedestrian, transit, and bicycle facilities) and by being attentive to the needs of vulnerable and marginalized communities.
- T 1.3** Design transportation infrastructure in urban centers and villages to support compact, accessible, and walkable neighborhoods for all ages and abilities.
- T 1.4** Design transportation facilities to be compatible with planned land uses and consider the planned scale and character of the surrounding neighborhood.
- T 1.5** Invest in transportation projects and programs that further progress toward meeting Seattle’s mode-share goals, in Transportation Figures 1 and 2, and reduce dependence on personal automobiles, particularly in urban centers.

Transportation Figure 1

Mode-Share Targets for All Work Trips to Seattle and Its Urban Centers

Percentage of work trips made by travel modes other than driving alone

Area	2014	2035 Target
Downtown	77%	85%
First Hill/Capitol Hill	58%	70%
Uptown	48%	60%
South Lake Union	67%	80%
University District	73%	85%

Area	2014	2035 Target
Northgate	30%	50%
Seattle	57%	65%

Transportation Figure 2

Mode-Share Targets for Residents of Seattle and Its Urban Centers

Percentage of nonwork trips made using travel modes other than driving alone

Area	2014	2035 Target
Downtown	88%	90%
First Hill/Capitol Hill	80%	85%
Uptown	82%	85%
South Lake Union	76%	85%
University District	79%	90%
Northgate	46%	55%
Seattle	67%	75%

T 1.6 Enhance goods movement to, within, and between Seattle’s manufacturing/ industrial centers and urban villages and business districts.

Make the Best Use of the Streets We Have

Discussion

The public street space in Seattle needs to accommodate several different functions to serve existing and future activity. Because it will be difficult to expand this available public street space in any significant way, it is important for the City to use the existing streets efficiently and wisely. This section of the Plan establishes the policy framework for making those decisions.

The City has adopted master plans to address nonautomobile modes of travel—pedestrian, bicycle, transit, and freight movement—drawing on extensive community input. In planning for how to use streets, it is useful to look at the need to provide space for pedestrian activities, travelways for various types of vehicles, and a flex area along the curb for making transitions. Pedestrian activities include walking as well as utilizing bus shelters, bike racks,

and sidewalk cafés. The flex area provides parking, bus stops, and passenger and freight loading, and the area that is used for parking may be used for mobility during peak times. In addition, space should be available for parklets, play streets, and other activating uses of the street. Providing space for all these functions efficiently and where they are needed helps make the most of a limited resource.

Not every function can fit in every street. The goals and policies in this section provide direction on integrating and, where necessary, prioritizing functions within the different parts of a street. These policies also recognize that collectively two or more streets can combine to serve as a “complete corridor,” since not every street can accommodate every need.

GOAL

- TG 2** Allocate space on Seattle’s streets to safely and efficiently connect and move people and goods to their destinations while creating inviting spaces within the rights-of-way.

POLICIES

- T 2.1** Devote space in the street right-of-way to accommodate multiple functions of mobility, access for commerce and people, activation, landscaping, and storage of vehicles.
- T 2.2** Ensure that the street network accommodates multiple travel modes, including transit, freight movement, pedestrians, bicycles, general purpose traffic, and shared transportation options.
- T 2.3** Consider safety concerns, modal master plans, and adjacent land uses when prioritizing functions in the pedestrian, travelway, and flex zones of the right-of-way.
- T 2.4** Use pedestrian design guidance in the Right-of-Way Improvements Manual and policy guidance from the modal master plans to determine adequacy of the pedestrian realm, before allocating space to the flex zone or travelway. Within the pedestrian realm, prioritize space to address safety concerns, network connectivity, and activation.
- T 2.5** Prioritize mobility needs in the street travelway based on safety concerns and on the recommended networks and facilities identified in the respective modal plans.
- T 2.6** Allocate space in the flex zone to accommodate access, activation, and greening functions, except when use of the flex zone for mobility is critical to address safety or to meet connectivity needs identified in modal master plans. When mobility is needed only part of the day, design the space to accommodate other functions at other times.
- T 2.7** Assign space in the flex zone to support nearby land uses, provide support for modal plan priorities, and accommodate multiple functions.

Transportation Figure 3

Priorities for Right-of-Way “Flex Zone” by Predominant Use of Area

Commercial/Mixed-Use Areas	Industrial Areas	Residential Areas
Modal plan priorities	Modal plan priorities	Modal plan priorities
Access for commerce	Access for commerce	Access for people
Access for people	Access for people	Access for commerce
Activation	Storage	Greening
Greening	Activation	Storage
Storage	Greening	Activation

- T 2.8** Employ the following tactics to resolve potential conflicts for space in the right-of-way:
- Allocate needed functions across a corridor composed of several streets or alleys, if all functions cannot fit in a single street
 - Share space between travel modes and uses where safe and where possible over the course of the day
 - Prioritize assignment of space to shared and shorter-duration uses
 - Encourage off-street accommodation for nonmobility uses, including parking and transit layover
 - Implement transportation- and parking-demand management strategies to encourage more efficient use of the existing right-of-way
- T 2.9** Develop a decision-making framework to direct the planning, design, and optimization of street right-of-way.
- T 2.10** Identify street types in the Right-of-Way Improvements Manual, and have those street types correspond to the land uses designated in this Plan.
- T 2.11** Design sidewalks in urban centers, urban villages, and areas designated as pedestrian zones in the Land Use Code to meet the dimensional standards as specified in the Right-of-Way Improvements Manual to foster vibrant pedestrian environments in these areas.
- T 2.12** Designate the following classifications of arterials:
- **Principal arterials:** roadways that are intended to serve as the primary routes for moving traffic through the city and for connecting urban centers and urban villages to one another or to the regional transportation network

- **Minor arterials:** roadways that distribute traffic from principal arterials to collector arterials and access streets
- **Collector arterials:** roadways that collect and distribute traffic from principal and minor arterials to local access streets or provide direct access to destinations

- T 2.13** Preserve and enhance the boulevard network both for travel and as a usable open-space system for active transportation modes.
- T 2.14** Maintain, preserve, and enhance the City’s alleys as a valuable network for public spaces and access, loading and unloading for freight, and utility operations.
- T 2.15** Create vibrant public spaces in and near the right-of-way that foster social interaction, promote access to walking, bicycling, and transit options, and enhance the public realm.

Transportation Options

Discussion

Transit, bicycling, walking, and shared transportation services reduce collisions, stress, noise, and air pollution, while increasing social contact, economic vitality, affordability, and overall health. They also help use right-of-way space more efficiently and at lower costs. The best way to get Seattleites to take advantage of these options is to make them easy choices for people of all ages and abilities.

Some people in the city have fewer options for travel. For instance, we know from the American Community Survey that roughly a quarter of all households of color in Seattle, including a third of black households, do not have a motor vehicle at home. Research by King County found that people in households with incomes under \$35,000 are much more likely than others to rely on transit for all their transportation needs. Providing more transit options for these communities is one way the City can use its transportation planning to improve race and social equity in the city.

Share of Seattle Households without Access to a Vehicle
By Race/Ethnicity of Householder

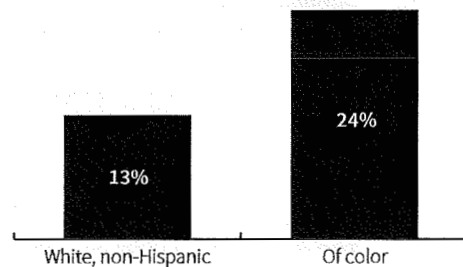

Source: 2011–2013 ACS, US Census Bureau

The plans that the City has developed for individual travel modes (pedestrian, bicycle, and transit) include strategies and projects that will improve transportation choices in the city. In prioritizing investments, these plans balance development levels with equity, ensuring

that people who are dependent on transit or vehicle use because of age, disability, or financial considerations are well served. For more information on the specific investments that the City plans to make to support transit, bicycle use, and walking, refer to the maps in Transportation Figures 4–7.

While not everyone can always walk, bike, use a car-share service, or ride transit, the City can reduce the number of drive-alone trips that residents, employees, and visitors take, and even the need to own a personal vehicle. If the City offers people safe, affordable, and comfortable travel choices, they will be more likely to use them. Improving transportation choices can protect the environment, enhance the local economy, and support healthy and sustainable communities. If more people use different types of transportation during the busiest times of day (generally the late-afternoon peak commute time), more people and goods can get to their destinations in a reasonable time. Reducing drive-alone trips at this time of day is consistent with the City's overall commute-trip reduction goals.

To make these options work, the City needs to help residents understand the options that are available so they can choose the ones that will work best for them. Having information about travel choices can influence where people choose to live and how they move about the city.

In helping residents make these decisions, the City must consider all aspects of the transportation system. One way the City can affect many aspects of the system is through transportation-demand management, a technique that aims to reduce travel impacts on the system, particularly drive-alone trips at congested times of the day. Transportation-demand management includes looking at the role of parking, since its availability, cost, and proximity to destinations are important considerations for many as they choose whether to drive or take advantage of other travel options. Especially for people using transit options to travel across the city or the region, there is a need to provide efficient ways to get to and from the transit. This is often called first-mile and last-mile travel because it can involve getting from home to a transit station on one end of a trip and from a transit station to a job on the other end. The first and last mile can often be traveled by walking, biking, ride sharing, or local bus service.

Transportation Figure 4

Priority Corridors for Transit Investments

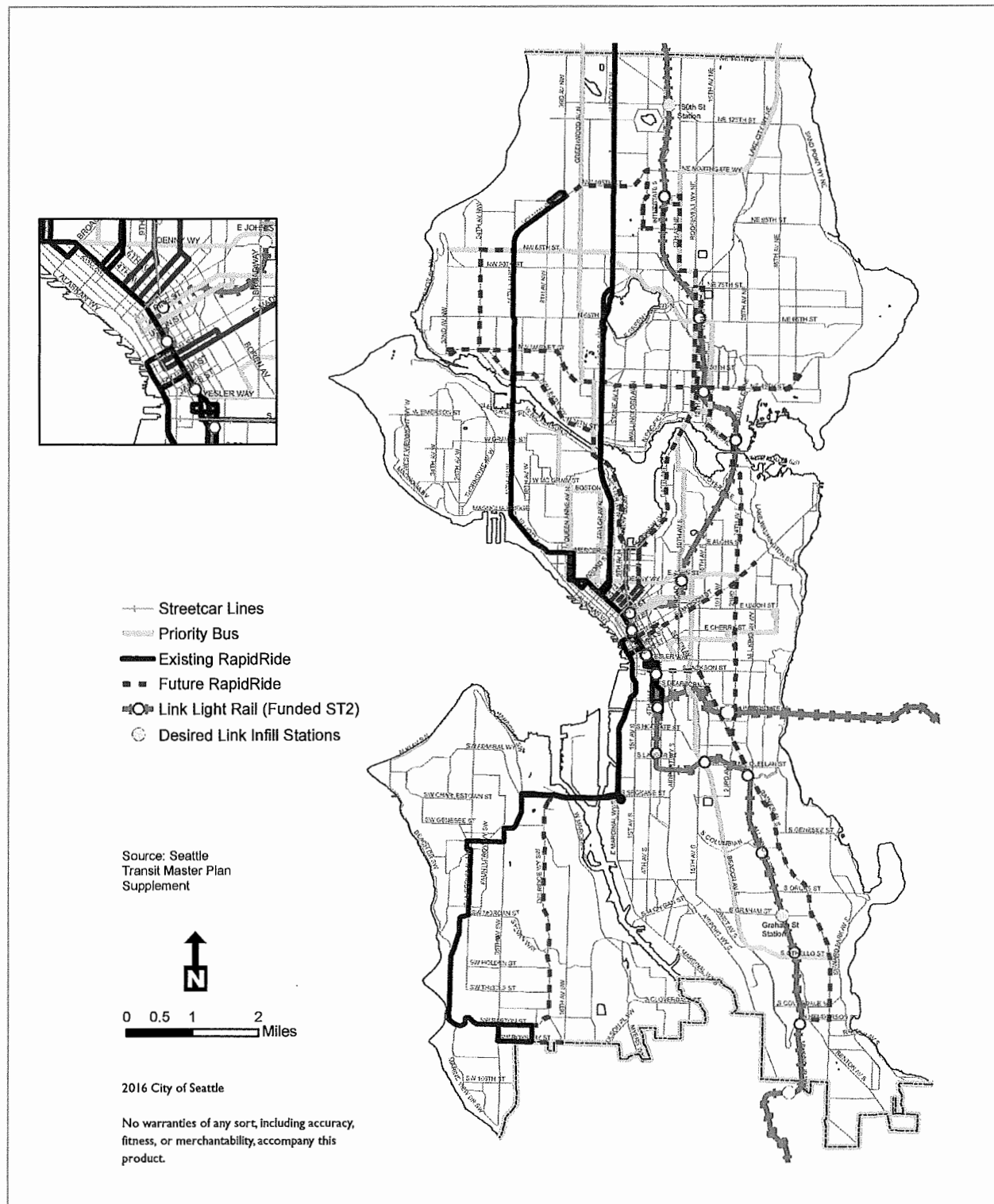

Transportation Figure 5

Planned Frequent Transit Service Network

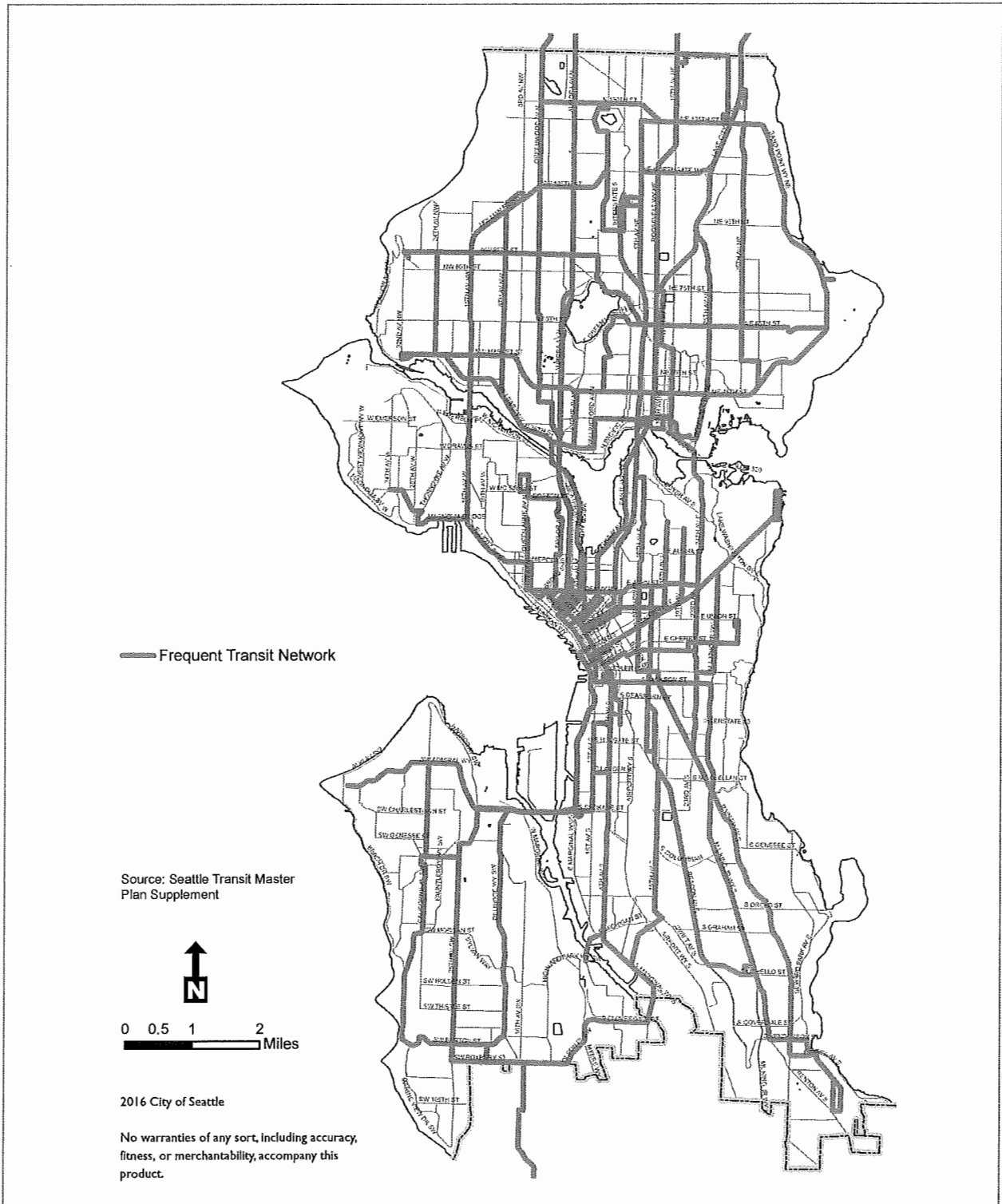

Transportation Figure 6

Recommended Bicycle Network

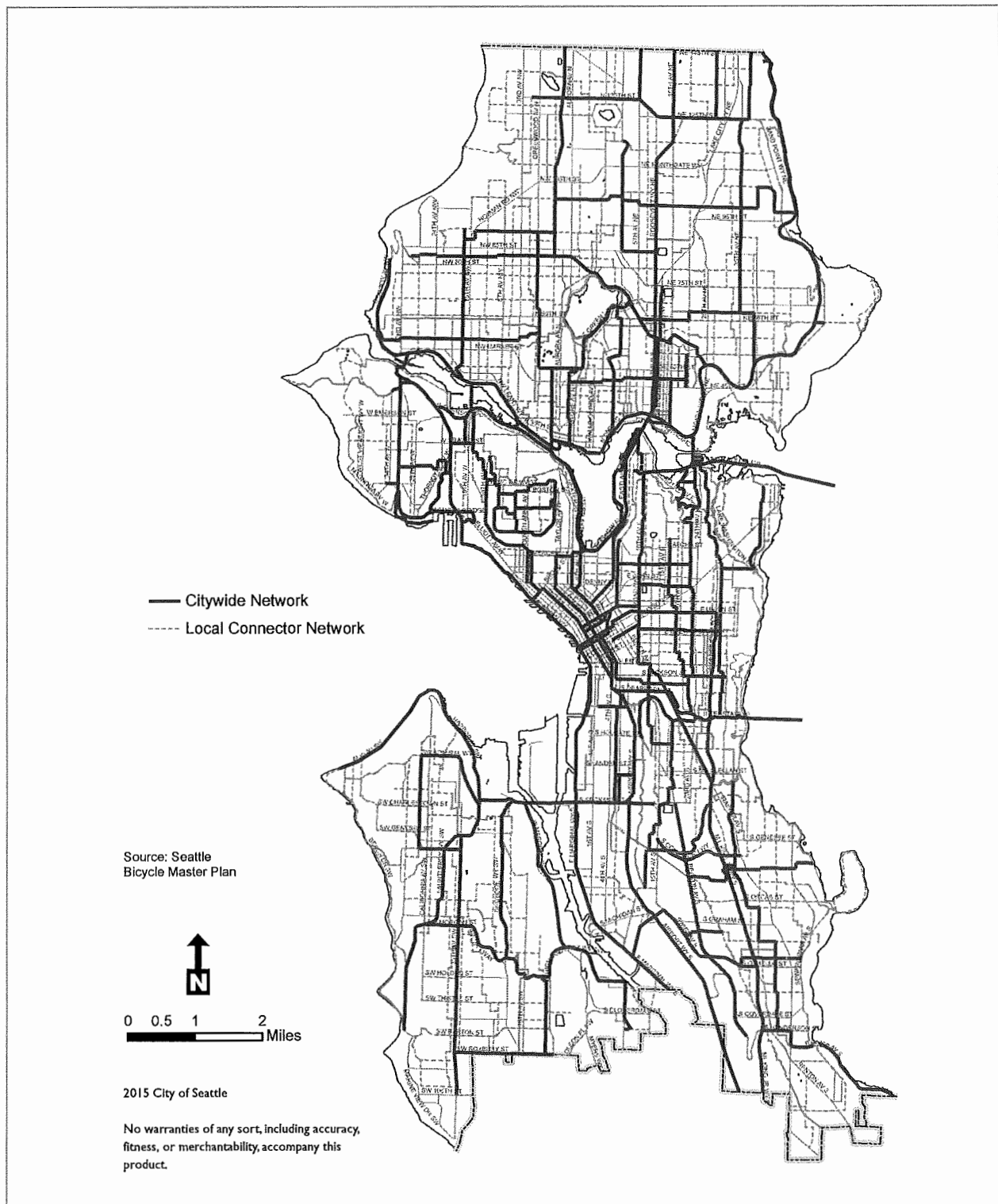

Transportation Figure 7

Pedestrian Priority Investment Areas

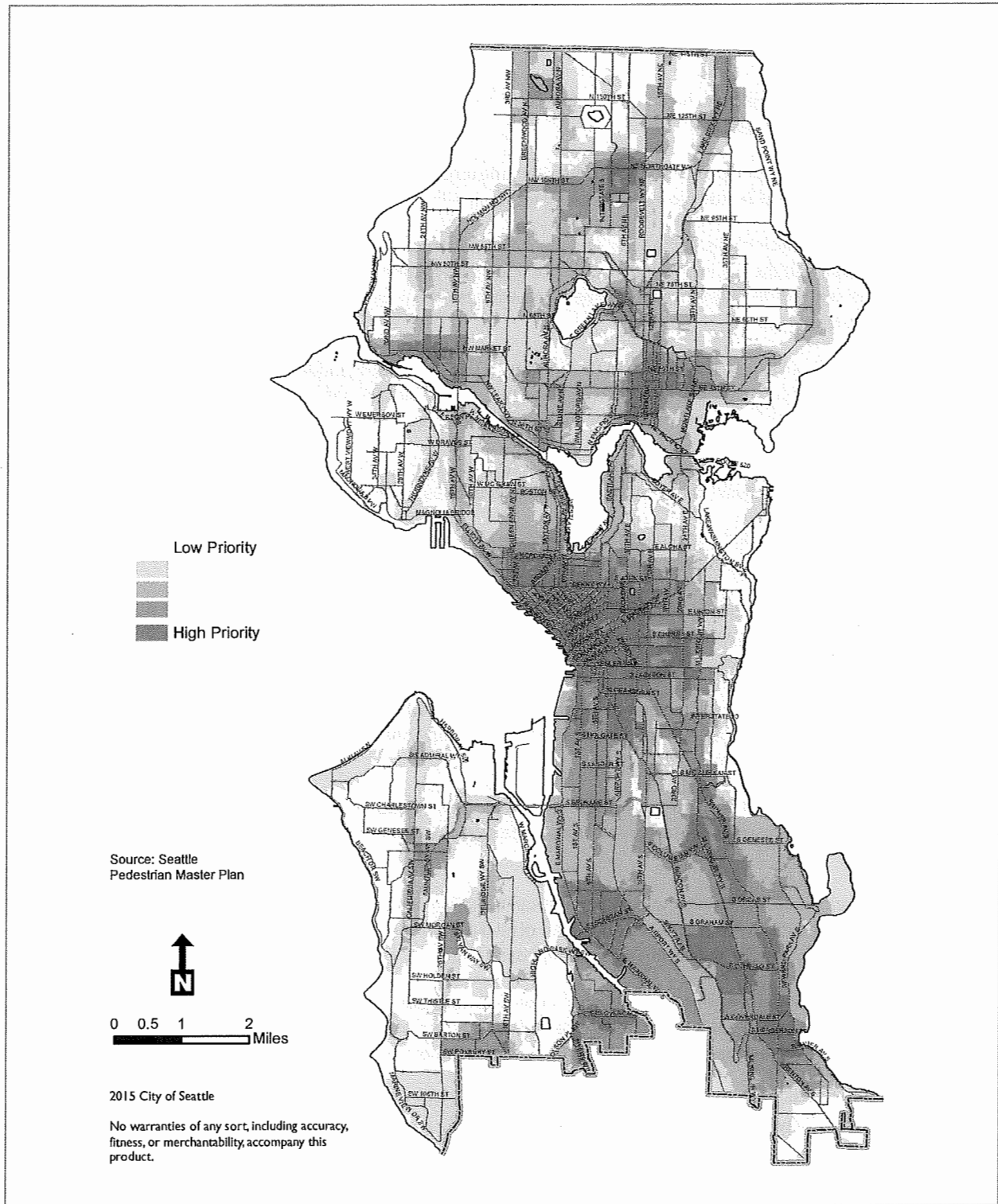

GOAL

- TG 3** Meet people's mobility needs by providing equitable access to, and encouraging use of, multiple transportation options.

POLICIES

- T 3.1** Develop and maintain high-quality, affordable, and connected bicycle, pedestrian, and transit facilities.
- T 3.2** Improve transportation options to and within the urban centers and urban villages, where most of Seattle's job and population growth will occur.
- T 3.3** Consider the income, age, ability, and vehicle-ownership patterns of populations throughout the city in developing transportation systems and facilities so that all residents, especially those most in need, have access to a wide range of affordable travel options.
- T 3.4** Develop a citywide transit system that includes a variety of transit modes to meet passenger capacity needs with frequent, reliable, accessible, and safe service to a wide variety of destinations throughout the day and week.
- T 3.5** Prioritize transit investments on the basis of ridership demand, service to populations heavily reliant on transit, and opportunities to leverage funding.
- T 3.6** Make transit services affordable to low-income residents through programs that reduce household transportation costs.
- T 3.7** Optimize operations of bus rapid transit, RapidRide, and streetcar corridors by adjusting signals and consider providing exclusive transit lanes to promote faster travel times for transit than for automobile travel.
- T 3.8** Expand light rail capacity and bus reliability in corridors where travel capacity is constrained, such as crossing the Lake Washington Ship Canal or the Duwamish River, or through the Center City.
- T 3.9** Provide high-quality pedestrian, bicycle, and bus transit access to high-capacity transit stations, in order to support transit ridership and reduce single-occupant vehicle trips.
- T 3.10** Develop and maintain bicycle and pedestrian facilities, including public stairways, that enhance the predictability and safety of all users of the street and that connect to a wide range of key destinations throughout the city.
- T 3.11** Look for opportunities to reestablish or improve connections across I-5 by creating new crossings or enhancing streets where I-5 crosses overhead, especially where these can also enhance opportunities for development or open space.
- T 3.12** Prioritize bicycle and pedestrian investments on the basis of increasing use, safety, connectivity, equity, health, livability, and opportunities to leverage funding.

- T 3.13** Develop facilities and programs, such as bike sharing, that encourage short trips to be made by walking or biking.
- T 3.14** Develop and implement programs to educate all users of the street on rules of the road, rights, and responsibilities.
- T 3.15** Support and plan for innovation in transportation options and shared mobility, including car sharing, bike sharing, and transportation network companies, that can increase travel options, enhance mobility, and provide first- and last-mile connections for people.
- T 3.16** Implement new technologies that will enhance access to transportation and parking options.
- T 3.17** Implement curb-space management strategies such as parking time limits, on-street parking pricing, loading zones, and residential parking programs to promote transportation choices, encourage parking turnover, improve customer access, and provide for efficient allocation of parking among diverse users.
- T 3.18** Consider roadway pricing strategies on city arterials to manage demand during peak travel times, particularly in the Center City.
- T 3.19** Consider replacing short-term parking that is displaced by construction or new transportation projects only when the project results in a concentrated and substantial amount of on-street parking loss.
- T 3.20** Design and manage the transportation system, including on-street parking, so that people with disabilities have safe and convenient access to their destinations, while discouraging use of disabled parking permits for commuter use in areas of high short-term parking demand.

Transportation Effects on the Environment

Discussion

Transportation policies that encourage use of nonautomobile travel options support not only the City's growth strategy but also its environmental goals, including those related to climate change. Cars, buses, trucks, and other motorized transportation make up Seattle's largest source of greenhouse gas emissions, and the City's Climate Action Plan sets high standards for reducing greenhouse gas emissions. Using more fuel-efficient transportation options to move larger numbers of people on well-designed and well-maintained streets is a crucial step to creating a healthy urban environment. By reducing the need for personal car use, the City can also reduce congestion and provide more opportunities to reallocate public right-of-way for trees and landscaping. Providing and promoting a wider variety of transportation options is also integral to achieving these environmental goals.

GOAL

- TG 4** Promote healthy communities by providing a transportation system that protects and improves Seattle’s environmental quality.

POLICIES

- T 4.1** Design and operate streets to promote green infrastructure, new technologies, and active transportation modes while addressing safety, accessibility, and aesthetics.
- T 4.2** Enhance the public street tree canopy and landscaping in the street right-of-way.
- T 4.3** Reduce drive-alone vehicle trips, vehicle dependence, and vehicle-miles traveled in order to help meet the City’s greenhouse gas reduction targets and reduce and mitigate air, water, and noise pollution.
- T 4.4** Work to reduce the use of fossil fuels and promote the use of alternative fuels.
- T 4.5** Encourage the use of electric-powered vehicles and the provision and expansion of electric-vehicle charging stations.
- T 4.6** Improve mobility and access for freight in order to reduce truck idling, improve air quality, and minimize the impacts of truck parking and movement in residential areas.

Support a Vibrant Economy

Discussion

The movement of goods and services is critical to economic development in Seattle and the region. Seattle’s businesses and residents rely on freight routes for safe and timely transportation of goods. Freight carriers depend on a well-functioning network of rail, water, air, and truck transportation. The City’s Freight Master Plan identifies the city’s overall truck freight network and prioritizes investments for freight mobility projects. Transportation Figure 8 shows the major truck streets identified by the City. In addition to goods movement, a well-designed transportation network supports a thriving economy by enhancing access to jobs, businesses, schools, and recreation. This kind of easy access adds to the vibrancy of the city’s urban centers and urban villages.

Transportation Figure 8

Major Truck Streets

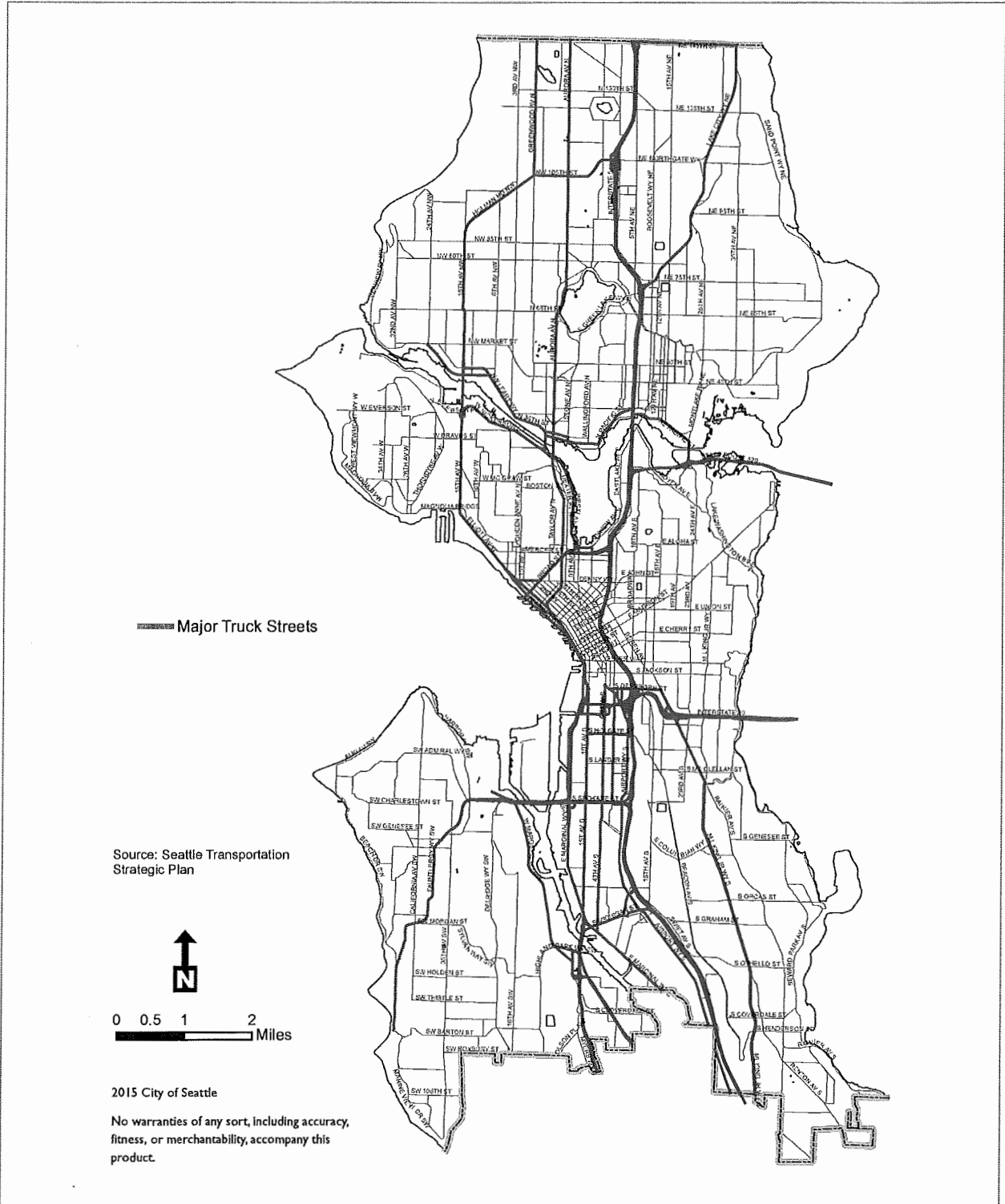

GOAL

- TG 5** Improve mobility and access for the movement of goods and services to enhance and promote economic opportunity throughout the city.

POLICIES

- T 5.1** Enhance Seattle's role as the hub for regional goods movement and as a gateway to national and international suppliers and markets.
- T 5.2** Develop a truck freight network in the Freight Master Plan that connects the city's manufacturing/industrial centers, enhances freight mobility and operational efficiencies, and promotes the city's economic health.
- T 5.3** Ensure that freight corridors are designed, maintained, and operated to provide efficient movement of truck traffic.
- T 5.4** Use intelligent transportation system technology to alert motorists, bicyclists, and pedestrians to the presence and anticipated length of closures due to train crossings and bridge openings for water vessels.
- T 5.5** Evaluate the feasibility of grade separation in locations where train-induced street closings result in significant delays and safety issues for other traffic, and improve the safety and operational conditions at rail crossings of city streets.
- T 5.6** Work with freight stakeholders and the Port of Seattle to maintain and improve intermodal freight connections involving Port container terminals, rail yards, industrial areas, airports, and regional highways.
- T 5.7** Support efficient and safe movement of goods by rail where appropriate, and promote efficient operation of freight rail lines and intermodal yards.
- T 5.8** Increase efficient and affordable access to jobs, education, and workforce training in order to promote economic opportunity.
- T 5.9** Improve access to urban villages and other neighborhood business districts for customers and delivery of goods.
- T 5.10** Build great streetscapes and activate public spaces in the right-of-way to promote economic vitality.

Safety

Discussion

Safety guides every decision that the Seattle Department of Transportation makes for transportation system operation and design. People expect to feel safe as they use streets, transit facilities, sidewalks, and trails. Collisions involving pedestrians or people riding bicycles are

a relatively small percentage of overall collisions in the city but represent a much higher percentage of the serious injuries and fatalities in the city. When we invest in protecting our most vulnerable road users, such as pedestrians and bicyclists, we help build strong communities where residents and visitors are more likely to walk or bike, especially for short trips. Safer streets are also more efficient streets; they have fewer and less severe collisions, allowing people and goods to move safely and efficiently. In addition to making safety improvements, Seattle works to build a culture of mutual awareness between travelers. The City respects the right of all to travel safely regardless of how they choose to get around.

GOAL

TG 6 Provide and maintain a safe transportation system that protects all travelers, particularly the most vulnerable users.

POLICIES

- T 6.1** Reduce collisions for all modes of transportation and work toward a transportation system that produces zero fatalities and serious injuries to attain the City's Vision Zero objectives.
- T 6.2** Enhance community safety and livability through measures such as reduced speed limits, lane rechannelization, and crossing improvements.
- T 6.3** Consider lowering speed limits on residential streets and arterials as a way to reduce collision rates and improve safety.
- T 6.4** Minimize right-of-way conflicts to safely accommodate all travelers.
- T 6.5** Improve safety for all modes of transportation on streets heavily used by trucks.
- T 6.6** Invest in education measures that increase mutual awareness among motorists, pedestrians, and bicyclists.
- T 6.7** Implement innovative and effective measures to improve safety that combine engineering, education, evaluation, and enforcement.
- T 6.8** Emphasize safety as a consideration in all transportation plans and projects, including project prioritization criteria.
- T 6.9** Use complete street principles, traffic-calming, and neighborhood traffic control strategies to promote safe neighborhood streets by discouraging cut-through traffic.

Connecting to the Region

Discussion

Seattle is the largest employment and cultural center in the Puget Sound region. It is also a destination for people from all over the area for work, shopping, and recreation. The city is served by a number of state and regional transportation facilities, including two interstate highways; several state highways; a regional light rail, commuter rail, and bus system; a ferry network; waterways; and railroads. While the bulk of the Transportation element addresses transportation within the city limits, this section provides guidance for larger regional projects that affect Seattle. It also provides guidance for Seattle's participation in regional transportation planning and funding efforts.

GOAL

- TG 7** Engage with other agencies to ensure that regional projects and programs affecting Seattle are consistent with City plans, policies, and priorities.

POLICIES

- T 7.1** Coordinate with regional, state, and federal agencies; other local governments; and transit providers when planning and operating transportation facilities and services that reach beyond the city's borders.
- T 7.2** Support completion of the freeway high-occupancy-vehicle lane system throughout the Central Puget Sound region and continued use of that system for promoting more efficient travel.
- T 7.3** Limit freeway capacity expansions intended primarily to accommodate drive-alone users to allow only spot improvements that enhance safety or remove operational constraints in specific locations.
- T 7.4** Support a strong regional ferry system that maximizes the movement of people, freight, and goods.
- T 7.5** Plan for the city's truck freight network, developed as part of the Freight Master Plan, to connect to the state and regional freight network, and to continue providing good connections to regional industrial and warehouse uses.
- T 7.6** Work with regional transit agency partners to expand and optimize cross-jurisdictional regional light rail and bus transit service investments that function as a single, coordinated system to encourage more trips to, from, and within Seattle on transit.
- T 7.7** Work with regional transit agencies to encourage them to provide service that is consistent with this Plan's growth goals and strategy.
- T 7.8** Support regional transportation pricing and tolling strategies that help manage regionwide transportation demand.

Operating and Maintaining the Transportation System

Discussion

Thoughtful operation and maintenance of the transportation system promotes safety, efficiency, infrastructure preservation, and a high-quality environment. Spending money on maintaining and preserving the system today can prevent spending more dollars on replacing parts of the system later. This is particularly true for the more expensive and vital transportation assets, such as pavement, sidewalks, parking pay stations, intelligent transportation system devices, traffic-signal infrastructure, and bridges.

Since the City makes and maintains its transportation improvements with taxpayer money, it must spend every dollar wisely and in a way that is consistent with the City's overall vision. The City keeps a comprehensive inventory of transportation assets that includes information about the condition of its most valuable assets. The City uses performance measures to decide whether and when to repair or replace infrastructure. In addition to planning for future maintenance, the City must address the significant backlog of unmet maintenance needs that currently exists.

GOAL

- TG 8** Maintain and renew existing transportation assets to ensure the long-term viability of investments, reduce ongoing costs, and promote safe conditions.

POLICIES

- T 8.1** Maintain the transportation system to keep it operating and to maximize its useful life.
- T 8.2** Operate the transportation system in a way that balances the following priorities: safety, mobility, accessibility, social equity, placemaking, infrastructure preservation, and resident satisfaction.
- T 8.3** Employ state-of-the-art intelligent transportation systems to increase efficiency of movement and reduce travel delays for all modes.
- T 8.4** Repair transportation facilities before replacement is necessary; replace failed facilities when replacement is more cost-effective than continuing to repair.
- T 8.5** Optimize traffic-signal corridors, taking the needs of all types of transportation into account.
- T 8.6** Designate a heavy haul network for truck freight to provide efficient freight operations to key port terminals and intermodal freight facilities.

- T 8.7** Mitigate construction impacts from City and private projects on the use of the street right-of-way and on the operation of the transportation system, especially for vulnerable populations.
- T 8.8** Look for innovative ways to create training, youth employment, and living wage opportunities for marginalized populations in the construction and major maintenance of transportation facilities.

Measuring Level of Service

Discussion

To accommodate the growth anticipated in this Plan and the increased demands on the transportation system that come with that growth, the Plan emphasizes strategies to increase travel options. Those travel options are particularly important for connecting urban centers and urban villages during the most congested times of day. Strategies for increasing travel options include concentrating development in urban villages well served by transit, completing the City’s modal plan networks, and reducing drive-alone vehicle use during the most congested times of day. As discussed earlier in this Transportation element, using the current street right-of-way as efficiently as possible means encouraging forms of travel other than driving alone.

In order to help advance this Plan’s vision, the City will measure the level of service (LOS) on its transportation facilities based on the share of all trips that are made by people driving alone. That measure focuses on travel that is occurring via the least space-efficient mode. By shifting travel from drive-alone trips to more efficient modes, Seattle will allow more people and goods to travel in the same amount of right-of-way. Because buses are the primary form of transit ridership in the city and buses operate on the arterial system, the percentage of trips made that are not drive-alone also helps measure how well transit can move around the city. A more detailed description of the City’s transportation LOS system can be found in the **Transportation Appendix**.

GOAL

- TG 9** Use LOS standards as a gauge to assess the performance of the transportation system.

POLICIES

- T 9.1** Define arterial and transit LOS to be the share of drive-alone trips made during the late-afternoon peak period (3:00 to 6:00 p.m.).
- T 9.2** Provide a menu of transportation-demand management tools for future development to meet non-drive-alone mode share targets.
- T 9.3** Pursue strategies to reduce drive-alone trips in order to increase the ability of the city's transportation network to carry people.
- T 9.4** Assess the mode share LOS standards over time and adjust as necessary, based on review of other City transportation measures.

Funding

Discussion

The city's transportation network is vital to preserving the quality of life, prosperity, and health of all Seattleites. Only with adequate funding can Seattle continue to operate, maintain, and improve its transportation network.

In November 2015 Seattle voters approved the Levy to Move Seattle, which replaced the Bridging the Gap levy that expired at the end of 2015. The Levy to Move Seattle will provide \$930 million for transportation investments between 2016 and 2024 in three main categories: safety, congestion relief, and maintenance and preservation. This funding will help advance many of the policies in this Plan.

The City also has a commercial parking tax, which supports large capital improvement and preservation projects. In 2010 the City created the Seattle Transportation Benefit District (STBD), which has authority to generate revenues from additional sources not otherwise available to the City. The STBD imposed a twenty-dollar vehicle license fee, which provides an additional dedicated financial resource for addressing transportation needs. In addition, Seattle voters approved increased funding for bus transit service in 2014, which adds bus service to many of the highest-ridership routes in the city.

GOAL

- TG 10** Ensure that transportation funding is sufficient to operate, maintain, and improve the transportation system that supports the City's transportation, land use, economic, environmental, equity, and other goals.

POLICIES

- T 10.1** Maintain and increase dedicated local transportation funding by renewing or replacing the transportation levy and by maintaining or replacing the existing commercial parking tax and Seattle Transportation Benefit District.
- T 10.2** Work with regional and state partners to encourage a shift to more reliance on user-based taxes and fees, and on revenues related to impacts on the transportation system and the environment.
- T 10.3** Leverage local funding resources by securing grants from regional, state, and federal sources, and through contributions from those who benefit from improvements.
- T 10.4** Partner with other City departments, as well as regional transportation and public works agencies, to coordinate investments, maximize project integration, reduce improvement costs, and limit construction impacts on neighborhoods.
- T 10.5** Make strategic investment decisions consistent with City plans and policies.
- T 10.6** Prioritize investment by considering life-cycle costs, safety, environmental benefits, reduction of greenhouse gas emissions, and public health benefits. Race and social equity should be a key factor in selecting transportation investments.
- T 10.7** Consider use of transportation-impact fees to help fund transportation system improvements needed to serve growth.
- T 10.8** Prepare a six-year Capital Improvement Program (CIP) with projects and programs that are fully or partially funded.
- T 10.9** Develop prioritized lists of projects, consistent with City policies, and actively pursue funds to implement those projects.
- T 10.10** Identify and evaluate possible additional funding resources and/or alternative land use and transportation scenarios if the level of transportation funding anticipated in the six-year financial analysis (shown in Transportation Figures 9 and 10) falls short of the estimated amount.

Transportation Figure 9

Estimated Future Transportation Revenue

Source	Estimated Revenue in Millions (2016–2021)	
	Low	High
Seattle Transportation Benefit District Funding (vehicle license fee and sales tax)	\$300	\$357
Seattle Dedicated Transportation Funding	\$833	\$858
Grants and Partnerships	\$163	\$640

Source	Estimated Revenue in Millions (2016–2021)	
	Low	High
General Fund and Cumulative Reserve Fund	\$305	\$400
Seawall Levy and Waterfront Partnership	\$420	\$475
Long-Term Financing	\$100	\$145
Total	\$2,120	\$2,875

Transportation Figure 10

Estimated Future Transportation Expenditures

Category	Estimated Expenditures in Millions (2016–2021)	
	Low	High
Operations and Maintenance	\$406	\$430
Major Maintenance and Safety	\$750	\$844
Mobility and Enhancements	\$964	\$1,601
Total	\$2,120	\$2,875

Housing



Introduction

In the City's vision for the future, all people have access to housing that is safe, clean, and affordable. As Seattle grows, its housing supply grows and adapts to meet the needs of all households, regardless of color or income, including families with children, seniors, and people who are disabled. Our growing city does not force people from their homes; they are able to stay in their neighborhoods, with their established community resources and cultural institutions. Throughout the city, quality housing options exist for people of all backgrounds.

In the wake of the Great Recession, Seattle has experienced unprecedented growth in the number of housing units due to booming demand. The city added nearly twenty-one thousand housing units between 2013 and 2015, the highest number in a three-year period since at least 1980. Rents have increased sharply, particularly impacting lower-income

households. Stabilizing housing prices is a key step to stemming growing income inequality, a threat to the long-term strength of our region's economy.

Rising housing costs affect marginalized populations the most. Seattle has been shaped by its history of racial segregation and the economic displacement of communities of color. Over time, homeowners can gain significant wealth that they can pass down to their descendants, while renters face the risk of growing housing-cost burden. The result is significant economic disparity along racial lines. Addressing injustices and protecting marginalized populations is a primary focus of the Housing element of this Plan.

Households that spend more than half of their monthly income on housing costs are considered severely housing-cost burdened. About 22 percent of households of color and close to a third of African American households are severely housing-cost burdened.

Share of Seattle Households Who Are Severely Housing-Cost Burdened

by Race/Ethnicity of Person who Owns or Rents a Home

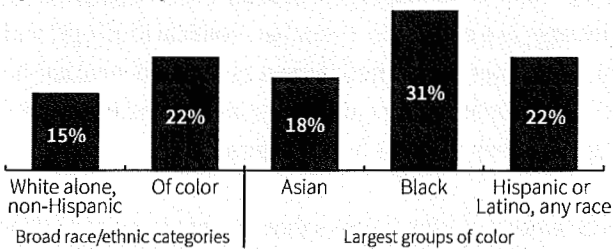

Source: 2006–2010 ACS CHAS special tabulation, US Census Bureau

One way the City works to address racial and social equity is by creating and preserving affordable housing, particularly for lower-income households. Public investments in affordable housing enable people to continue living in their neighborhoods. Creating affordable housing is also a way to expand housing options in historically unaffordable neighborhoods that have access to jobs, schools, and transit. As the City develops, evaluates, and implements land use and housing policies and programs, it engages historically underrepresented communities in the process. By collaborating with the larger community on these projects, the City aims to help reverse known trends of social and racial inequity.

This Housing element establishes goals and policies to address the housing needs of all Seattleites. Together, these goals and policies will contribute to building vibrant, resilient, and cohesive communities throughout our city. These goals and policies are grouped within the following five topic areas: Equal Access to Housing, Supply of Housing, Diversity of Housing, Housing Construction and Design, and Housing Affordability. Various policies in this element refer to “rent/income-restricted housing.” This means housing with conditions that legally restrict the income of the tenants who live there and the rents they may be charged. When this Plan refers to “affordable housing,” it generally means housing that lower-income households can afford without sacrificing essential needs like food and health care. Affordable housing includes rent/income-restricted housing, as well as housing that is low cost without any subsidy or incentive.

The **Housing Appendix** contains demographic information for the city and an analysis of housing need, as called for in the King County Countywide Planning Policies.

Equal Access to Housing

Discussion

The federal Fair Housing Act prohibits landlords from discriminating against or in favor of any individual or group based on race, religion, national origin, sex, color, disability, or familial status (that is, pregnancy or the presence of children under eighteen). These characteristics are referred to as “protected classes” under the law. The State of Washington and the City of Seattle have extended protection to additional classes, including marital status, sexual orientation, gender identity, age, use of Section 8 voucher, political ideology, and veteran or military status. Educating Seattleites about these federal, state, and local fair-housing laws—and enforcing them—is critical to making our city welcoming and inclusive. These laws increase housing choices for people of all incomes and backgrounds.

The City also supports removing other barriers that prevent families and individuals from securing housing. For example, the City’s approach to homelessness is to move homeless people into housing quickly and then provide them services as needed. By focusing on helping individuals and families quickly move into permanent housing, the City helps the homeless avoid a costly and lengthy series of steps from emergency shelter to transitional housing to permanent housing. Social service agencies nationwide have found that without stable housing, it is extremely difficult for someone to tackle problems, including those related to physical or mental health or addiction, that may have led to that person’s homelessness. Removing barriers to housing reduces homelessness and helps people avoid the humiliation and vulnerability caused by not having a home.

GOAL

H G1 Help all people have fair and equal access to housing in Seattle.

POLICIES

H 1.1 Help create a culture where everyone understands and respects the fair-housing rights protected by federal, state, and local laws.

H 1.2 Promote a diverse and inclusive city through housing programs that serve lower-income households.

- H 1.3** Encourage actions, such as affirmative marketing and fair-housing education and enforcement, to overcome historical patterns of segregation, promote fair-housing choices, and foster inclusive communities that are free from discrimination.
- H 1.4** Remove barriers that prevent lower-income households from using rental assistance throughout Seattle, particularly in areas with frequent transit, schools, parks, and other amenities.
- H 1.5** Identify and remove, in coordination with other jurisdictions in the region, potential barriers to stable housing for individuals and families, such as housing screening practices that do not align with all applicable federal, state, and local laws in their use of criminal and civil records and that perpetuate disparate impacts of our criminal justice system and other institutions.

Supply of Housing

Discussion

Seattle is a fast-growing city, and as the population increases, demand for housing will continue to increase as well. The City is planning for seventy thousand new housing units by 2035. The majority of new housing is planned for urban centers and villages. These are the areas where investments in transportation, open space, and services are planned or have already been made. Record levels of housing development in the last few years have not been enough to keep up with the demand for housing that is caused by rapid economic growth. That inability of the market to meet demand has contributed to rising rents in Seattle.

In 2015, the mayor announced the Seattle Housing Affordability and Livability Agenda (HALA). The HALA contains sixty-five recommendations for how Seattle can accommodate more housing. It includes steps that will help both for-profit and nonprofit housing developers build and preserve affordable housing. The HALA outlines a road map to build or preserve fifty thousand housing units over the next ten years, including twenty thousand units of rent/income-restricted housing. As housing development continues, the City will promote policies that limit displacement, stabilize marginalized populations in their communities, and encourage a net increase in affordable housing over time.

GOAL

- H G2** Help meet current and projected regional housing needs of all economic and demographic groups by increasing Seattle's housing supply. Strive to add or preserve fifty thousand housing units by 2025, including twenty thousand rent/income-restricted housing units.

POLICIES

- H 2.1** Allow and promote innovative and nontraditional housing design and construction types to accommodate residential growth.
- H 2.2** Identify publicly owned sites suitable for housing, and prioritize use of sites, where appropriate, for rent/income-restricted housing for lower-income households.
- H 2.3** Consider Land Use Code and Building Code regulations that allow for flexible reuse of existing structures in order to maintain or increase housing supply, while maintaining life-safety standards.
- H 2.4** Encourage use of vacant or underdeveloped land for housing and mixed-use development, and promote turning vacant housing back into safe places to live.
- H 2.5** Encourage the replacement of housing that is demolished or converted to nonresidential or higher-cost residential use.

Diversity of Housing

Discussion

Seattle needs a greater variety of housing types and a wider spectrum of affordability. Seattle's high housing costs are making it increasingly difficult for many households to live in the city. Even middle-income households, especially families with children, struggle to meet the high prices of housing in most areas of the city. To address these issues, the City will consider allowing different types of housing than some zoning rules currently permit. Courtyard housing, row housing, and apartments are examples of potentially affordable and family-friendly housing options. The policies below encourage a broader array of housing choices in Seattle.

GOAL

- H G3** Achieve a mix of housing types that provide opportunity and choice throughout Seattle for people of various ages, races, ethnicities, and cultural backgrounds and for a variety of household sizes, types, and incomes.

POLICIES

- H 3.1** Identify and implement strategies, including development standards and design guidelines reflecting unique characteristics of each neighborhood, to accommodate an array of housing designs that meet the needs of Seattle's varied households.
- H 3.2** Allow and encourage housing for older adults and people with disabilities, including designs that allow for independent living, various degrees of assisted living, and/

or skilled nursing care, in or near urban centers and urban villages where there is access to health care and other services and amenities.

- H 3.3** Encourage the development of family-sized housing affordable for households with a broad range of incomes in areas with access to amenities and services.
- H 3.4** Promote use of customizable modular designs and other flexible housing concepts to allow for households' changing needs, including in areas zoned for single-family use.
- H 3.5** Allow additional housing types in areas that are currently zoned for single-family development inside urban villages; respect general height and bulk development limits currently allowed while giving households access to transit hubs and the diversity of goods and services that those areas provide.

Housing Construction and Design

Discussion

High-quality housing design and construction can help protect our natural environment and resources, prepare for the challenges of climate change, and respond to changing housing needs over time. All Seattle housing should be safe, resilient, and well maintained. People generally have a common understanding of what constitutes safe housing. The Seattle Department of Construction and Inspections (SDCI) enforces codes that protect public health, safety, and general welfare, such as the Building Code and the Housing and Building Maintenance Code. Now that the majority of housing units in Seattle are rentals, the SDCI's rental inspection program is particularly important. In addition to being safe, homes must be resilient. That is, individuals, households, communities, and regions should be able to maintain livable conditions in the event of natural disasters, loss of power, or other interruptions of normally available services.

GOAL

- H G4** Achieve healthy, safe, and environmentally sustainable housing that is adaptable to changing demographic conditions.

POLICIES

- H 4.1** Provide programs, regulations, and enforcement to help ensure that all housing is healthy and safe and meets basic housing-maintenance requirements.
- H 4.2** Encourage innovation in residential design, construction, and technology, and implement regulations to conserve water, energy, and materials; reduce greenhouse gas emissions; and otherwise limit environmental and health impacts.

- H 4.3 Consider providing assistance for seismic retrofit of residential buildings, particularly those occupied by lower-income households, to reduce the risk of displacement after an earthquake.
- H 4.4 Increase housing opportunities for older adults and people with disabilities by promoting universal design features for new and renovated housing.
- H 4.5 Promote opportunities to combine housing and historic preservation efforts by rehabilitating structures of historic value for residential use.
- H 4.6 Promote access to public decision-making about housing for all Seattleites.
- H 4.7 Promote housing for all Seattleites that is safe and free from environmental and health hazards.
- H 4.8 Explore ways to reduce housing-development costs.

Housing Affordability

Discussion

Affordable housing for Seattle’s lower-income residents increases their ability to access opportunities in Seattle and helps reduce existing disparities. Research shows that investing in affordable housing for lower-income households yields positive social and economic outcomes, especially for families with children.

Washington State’s Growth Management Act (GMA) requires each jurisdiction to include an inventory and analysis of existing and projected housing needs in its Comprehensive Plan. King County’s Countywide Planning Policies (CPPs) provide additional direction and guidance for the inventory and analysis. The report on Seattle’s housing supply and needs is provided in the **Housing Appendix** of this Plan.

As of 2015, there were approximately 27,200 units of rent/income-restricted housing in Seattle. Although this number may seem large, there is still significant need for affordable housing for households at the lowest income levels.

Seattle also currently has some low-cost market-rate rental housing, although not nearly enough to meet demand. Higher-income households occupy a portion of this housing.

AMI (area median income): the annual median income for families in the Seattle area, as published by the US Department of Housing and Urban Development, with adjustments for household size assuming 1 person for studio units and 1.5 people per bedroom for other units

Lower-income includes the following subcategories:

Extremely low-income: a household whose income is equal to or less than 30 percent of AMI

Very low-income: a household whose income is greater than 30 percent of AMI and equal to or less than 60 percent of AMI

Low-income: a household whose income is greater than 60 percent of AMI and equal to or less than 80 percent of AMI

Moderate-income: a household whose income is greater than 80 percent of AMI and equal to or less than 100 percent of AMI

Middle-income: a household whose income is greater than 100 percent of AMI and equal to or less than 150 percent of AMI

Roughly a third of units that have rents affordable to households with income below 80 percent of the area median income (AMI) are actually rented by households with higher incomes. That leaves a shortage of rental units for the households who need them. There would be no shortage of units for households with incomes between 50 percent and 80 percent of AMI were it not for down-renting by higher-income households. That is not the case for units with rents affordable at or below 50 percent of AMI, where the affordable rental housing shortages far exceed those caused by down-renting.

The Housing Appendix presents information on renter households in Seattle that have incomes in three income ranges—0 to 30 percent of AMI, 30 to 50 percent of AMI, and 50 to 80 percent of AMI. The Housing Appendix shows that in the two lowest of the three categories, there are many more households than there are affordable and available rental units. For instance, households with incomes of 0 to 30 percent of AMI outnumber the affordable and available units by at least 23,500. Rent/income-restricted housing plays a critical role in ensuring that low-cost housing actually serves lower-income households.

To meet needs associated with growth, an estimated 27,500 to 36,500 additional housing units affordable to households with incomes at or below 80 percent of AMI will be needed by 2035. This includes 10,500 rent/income-restricted housing units for extremely low-income households.

The City's housing programs and regulatory strategies will continue to prioritize affordable housing for extremely low- and very low-income households. These households have the greatest housing need by far. The City assumes the large majority of units affordable to households with incomes between 60 percent and 80 percent of AMI will continue to be provided by the market.

Seattle in 2016 is in the midst of a housing-affordability crisis. The goals and policies in this Housing Affordability section help establish a framework for making Seattle a more affordable and equitable city.

GOAL

H G5 Make it possible for households of all income levels to live affordably in Seattle, and reduce over time the unmet housing needs of lower-income households in Seattle.

POLICIES

H 5.1 Pursue public and private funding sources for housing preservation and production to provide housing opportunities for lower-wage workers, people with special needs, and those who are homeless or at risk of being homeless.

- H 5.2** Expand programs that preserve or produce affordable housing, preferably long term, for lower-income households, and continue to prioritize efforts that address the needs of Seattle's extremely low-income households.
- H 5.3** Promote housing affordable to lower-income households in locations that help increase access to education, employment, and social opportunities, while supporting a more inclusive city and reducing displacement from Seattle neighborhoods or from the city as a whole.
- H 5.4** Monitor regularly the supply, diversity, and affordability of housing for households by income level, and use this information to help evaluate whether changes to housing strategies and policies are needed to encourage more affordable housing or to advance racial and social equity.
- H 5.5** Collaborate with King County and other jurisdictions in efforts to prevent and end homelessness and focus those efforts on providing permanent housing and supportive services and on securing the resources to do so.
- H 5.6** Increase housing choice and opportunity for extremely low- and very low-income households in part by funding rent/income-restricted housing throughout Seattle, especially in areas where there is a high risk of displacement. Also increase housing choice in areas where lower-cost housing is less available but where there is high-frequency transit service and other amenities, even if greater subsidies may be needed.
- H 5.7** Consider that access to high-frequency transit may lower the combined housing and transportation costs for households when locating housing for lower-income households.
- H 5.8** Strive for no net loss of rent/income-restricted housing citywide.
- H 5.9** Use strategies that will reduce the potential for displacement of marginalized populations when making decisions related to funding or locating rent/income-restricted housing.
- H 5.10** Encourage rental-housing owners to preserve, rehabilitate, or redevelop their properties in ways that limit housing displacement, maintain affordable, healthy, and safe living conditions for current residents, and consider cultural and economic needs of the surrounding neighborhood.
- H 5.11** Require advance notice to all tenants and payment of relocation assistance to tenants with household incomes below established thresholds before issuing permits for housing demolition, change of use, or substantial rehabilitation or before removing use restrictions from rent/income-restricted housing.
- H 5.12** Require culturally sensitive communication with the neighbors of proposed rent/income-restricted housing for extremely low- and very low-income households, with the goal of furthering fair housing.
- H 5.13** Seek to reduce cost burdens among Seattle households, especially lower-income households and households of color.

- H 5.14** Encourage and advocate for new federal, state, and county laws, regulations, programs, and incentives that would increase the production and preservation of lower-income housing.
- H 5.15** Encourage a shared responsibility between the private and public sectors for addressing affordable housing needs.
- H 5.16** Consider implementing a broad array of affordable housing strategies in connection with new development, including but not limited to development regulations, inclusionary zoning, incentives, property tax exemptions, and permit fee reductions.
- H 5.17** Consider using substantive authority available through the State Environmental Policy Act to require that new development mitigate adverse impacts on housing affordable for lower-income households.
- H 5.18** Consider implementing programs that require affordable housing with new development, with or without rezones or changes to development standards that increase development capacity.
- H 5.19** Consider requiring provision for housing, including rent/income-restricted housing, as part of major institution master plans and development agreements when such plans would lead to housing demolition or employment growth.
- H 5.20** Implement strategies and programs to help ensure a range of housing opportunities affordable for Seattle's workforce.
- H 5.21** Encourage major employers to fund local and regional affordable housing for lower-income, moderate-income, and middle-income households.
- H 5.22** Continue to promote best practices in use of green building materials, sustainability, and resiliency in policies for rent/income-restricted housing.
- H 5.23** Support programs that enable Seattle's lower-income homeowners to remain safely and affordably housed.
- H 5.24** Support financially sustainable strategies to provide homeownership opportunities for low-, moderate-, and middle-income households, especially for families with children, in part to enable these households to have a path toward wealth accumulation.

Capital Facilities



Introduction

Seattle has a comprehensive network of facilities that provide important services to the city. These are known as capital facilities. Maintaining and expanding them is critical for providing a high-quality of life as the city grows. These facilities include those owned and managed by the City, such as police and fire facilities, libraries, neighborhood service centers, City office space, and Seattle Center. Other capital facilities are ones that the City funds or otherwise supports, such as schools and health clinics. The City encourages non-City organizations, such as Seattle Public Schools and Public Health—Seattle & King County, to meet the goals and policies of this Comprehensive Plan. This section generally applies to buildings, and it does not apply to transportation infrastructure, utility infrastructure, or affordable-housing projects, which are discussed in other sections of this Plan.

Overall, the City's network of capital facilities is generally sufficient to accommodate forecasted housing and job growth through 2035. The **Capital Facilities Appendix** contains

information about City-owned facilities, including parks and libraries, as well as information about Seattle Public Schools. Unlike utilities and transportation, demand for capital facilities is determined largely by factors other than population, such as service areas or response times. However, the City continues to invest in existing and new facilities to improve the system and ensure that it remains relevant and useful to changing populations. Over the next twenty years, the City will aim to ensure that Seattle's capital facilities and programming

- *contribute to a high degree of personal and public health and safety;*
- *are equitably distributed based upon the different needs of individuals and communities;*
- *provide services that are relevant to neighborhoods throughout the city and are consistent with each community's priorities;*
- *support the City's goals of protecting and restoring the natural environment, in particular to reduce the impacts of and adapt to climate change;*
- *encourage the healthy physical, educational, and cultural development of children and adults;*
- *provide space for the city's growing population to gather, connect, and build community;*
- *respond to increasing diversity, changing technology, and additional demand on limited facilities; and*
- *are resilient to the effects of natural and human-made disasters.*

Achieving this vision will enable the City to create a capital facilities system that is an exceptional resource for all Seattleites. Part of the challenge in achieving the vision will be in recognizing and serving the disparate needs of different portions of the population.

People in different racial and ethnic groups and income segments vary in the extent and ways they use facilities provided by the City. Community Centers, for example, are used at a higher rate by residents of color than by other residents.

Community centers are designed to provide gathering spaces and recreational opportunities that are both culturally inclusive and affordable regardless of income.

The 2014 Parks Legacy Plan survey indicates that the Community Centers provided by the City are an especially important resource for persons of color. A greater share of respondents of color than whites said they visited a community center on a weekly basis.

Percentages of Survey Respondents in Each Group Who Visit a Community Center on a Weekly Basis

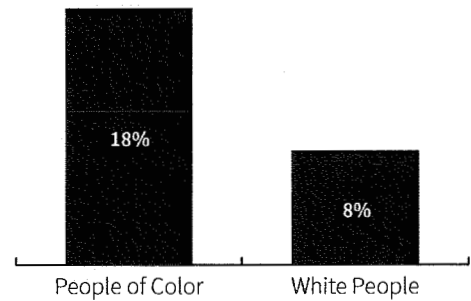

Source: September 2014 Parks Legacy Plan survey.

Strategic Investment

Discussion

The City has limited physical and financial resources available to maintain and improve our capital facilities network. The investment decisions we make will have long-term implications for our ability to serve a changing population. Consequently, Seattle must be strategic about investing these resources. This section describes the overarching goals and policies that apply to all aspects of capital facility development and management. These considerations will guide our actions through all aspects of working with capital facilities, including maintenance, acquisition, design, construction, and service-provision operations.

GOAL

CF G1 Develop and manage capital facilities to provide long-term environmental, economic, social, and health benefits for all residents and communities when using public investments, land, and facilities.

POLICIES

CF 1.1 Assess the policy and fiscal implications of potential major capital facility investments as part of the City's capital decision-making process. The evaluation should include consideration of a capital project's

- consistency with the Comprehensive Plan and functional plans;

- effects on Seattle’s environmental, social, economic, and human health over the lifetime of the investment;
 - contributions to an equitable distribution of facilities and services;
 - ability to support urban centers and villages that are experiencing or expecting high levels of residential and employment growth; and
 - total costs of ownership over a project’s life, including construction, operation, maintenance, and decommissioning.
- CF 1.2** Prioritize the maintenance of existing facilities, making efficient use of limited financial and physical resources.
- CF 1.3** Provide capital facilities that are models of environmental, economic, and social stewardship and that serve as examples for private development.
- CF 1.4** Provide capital facilities, such as libraries and community centers, that will keep Seattle attractive to families with children.
- CF 1.5** Encourage the protection, enhancement, and adaptive reuse of City-owned historic facilities.
- CF 1.6** Develop resilient capital facilities by considering the potential impacts of changing demographics, conditions, and events—such as climate change, technological changes, and natural and human-made disasters—in planning and investment decisions.
- CF 1.7** Structure user fees and scholarships to mitigate disproportionate cost burdens on low-income households.
- CF 1.8** Leverage investments to create training and living wage job opportunities, particularly for marginalized populations and local residents.
- CF 1.9** Continue to invest in Seattle Public Library programs and resources so that they remain free and open to all.

Facility Operations and Maintenance

Discussion

Seattle has already made substantial investments in developing existing facilities. For this reason, the operation and maintenance of the facilities we already have is key to making efficient use of resources. This section applies to daily operations and monitoring of these facilities, as well as minor improvements to them.

GOAL

- CF G2** Reduce ongoing resource consumption and day-to-day costs of the City's capital facilities, and protect their long-term viability, while serving the needs of the people who use them.

POLICIES

- CF 2.1** Use maintenance plans for capital facilities to make efficient use of limited financial and physical resources.
- CF 2.2** Manage existing facilities with a resource-conservation approach and the specific aim of continuously reducing energy use, water use, and stormwater impacts, as well as lowering utility costs.
- CF 2.3** Seek to achieve 20 percent energy savings from a 2008 baseline across the City's portfolio of buildings by 2020 and to achieve carbon neutrality by 2050.
- CF 2.4** Manage existing facilities to maintain healthy environments for occupants and users.

Facility Siting

Discussion

When the City builds new capital facilities, it's making substantial long-term investments. These are facilities that should serve the city for many decades to come. The location of these facilities can have major impacts on the long-term cost of providing services. They must be thoughtfully placed in order to provide the most benefits for local communities. As a result, Seattle must consider a wide range of questions in making these decisions. How will potential locations impact the efficiency of operations? Will services be provided equitably to all members of the community? What are the environmental consequences of each location, and how will they affect our ability to serve a growing population?

GOAL

- CF G3** Locate capital facilities to achieve efficient citywide delivery of services, support an equitable distribution of services, minimize environmental impacts, and maximize facilities' value to the communities in which they are located.

POLICIES

- CF 3.1** Encourage the location of new capital facilities in urban centers and villages to support future growth and attract both public and private investments.

- CF 3.2** Encourage the location of new capital facilities where they would support equitable distribution of services and address the needs of marginalized communities.
- CF 3.3** Locate capital facilities so that the majority of expected users can reach them by walking, bicycling, and/or taking public transit.
- CF 3.4** Seek to avoid siting new facilities in areas known to be prone to the effects of natural or human-made hazards, such as earthquake liquefaction-prone areas.
- CF 3.5** Encourage the joint use, reuse, and repurposing of existing City-owned land and buildings to further the City's long-range goals.
- CF 3.6** Consider future climate conditions during siting, particularly sea level, to help ensure capital facilities function as intended over their planned life cycle.
- CF 3.7** Consider alternate service delivery models that may be more resource efficient or that could better reach marginalized communities.

Facility Design and Construction

Discussion

As with location, the design and construction of capital facilities have a profound impact on how they are able to serve the city. The way the facilities are built affects the long-term cost of the services they provide, how well they serve the community, and their environmental impacts. By considering a range of perspectives, the City can design and build facilities that better suit the needs of Seattleites, now and in the future. The following policies address design and construction of the City's capital facilities, including major improvements and rehabilitation to existing facilities.

GOAL

- CF G4** Design and construct capital facilities so that they are considered assets to their communities and act as models of environmental, economic, and social stewardship.

POLICIES

- CF 4.1** Seek to make all capital facilities accessible and relevant to people of all abilities, socioeconomic backgrounds, ages, and cultures.
- CF 4.2** Strive for high levels of energy and water efficiency in City-owned facilities.
- CF 4.3** Use materials efficiently, prioritize local and environmentally preferable products, and minimize waste.

- CF 4.4** Create healthy indoor and outdoor environments for both users and occupants.
- CF 4.5** Provide building-design strategies that promote active living through the placement and design of stairs, elevators, and indoor and outdoor spaces.
- CF 4.6** Encourage a wide range of transportation options by promoting car sharing and by providing bicycle, transit, and electric-car charging facilities for visitors to City facilities.
- CF 4.7** Consider future climate conditions during design, including changes in temperature, precipitation, and sea level, to help ensure capital facilities function as intended over their planned life cycle.

Non-City Service Providers

Discussion

In addition to directly providing services through its own capital facilities, the City works with other entities that serve Seattle. These include Seattle Public Schools, Public Health—Seattle & King County, Washington State, and King County, as well as other jurisdictions and nonprofit organizations. Working together—for instance, through joint planning, funding other service providers, and allowing other groups to use City-owned property—we can better provide services to Seattle’s residents.

GOAL

- CF G5** Make efficient use of resources when investing in facilities and service delivery that involve other agencies and organizations.

POLICIES

- CF 5.1** Collaborate with other public and nonprofit organizations to include location within urban villages as a major criterion for selecting sites for new or expanded community-based facilities or public amenities.
- CF 5.2** Work with other public or nonprofit agencies to identify and pursue new colocation and joint-use opportunities in public facilities for community programs, services, and meetings.
- CF 5.3** Partner with Seattle Public Schools to plan for expected growth in student population, encourage the siting of new school facilities in or near urban centers and villages, and make it easy for students and families to walk and bike to school.

- CE 5.4** Join with other jurisdictions in King, Snohomish, and Pierce Counties to explore regional funding strategies for capital facilities, especially those that serve or benefit citizens throughout the region.
- CE 5.5** Use nontraditional strategies for service delivery, such as the leasing of City-owned buildings or funding of non-City facilities, where they would provide greater benefit to the city.

Utilities



Introduction

Utilities are basic services that keep the city working. As a highly urbanized area, Seattle has a fully developed and comprehensive utility infrastructure system. This system provides energy, drinking water, water for fire suppression, drainage, sewers, solid waste management, and communications services throughout the city. These services are managed by different public and private providers that must share space within the city's street right-of-way. Seattle City Light provides electricity throughout the city and beyond the city boundaries. Seattle Public Utilities provides drinking water, drainage and sewer systems, and solid waste services within the city limits. In addition, it provides water service directly or indirectly to much of King County. King County provides combined drainage and sewer services in portions of Seattle and is responsible for treating all wastewater generated in the city. The City's Department of Information Technology maintains an extensive data and fiber optic network. It shares conduit installation and maintenance with multiple partners, and leases excess fiber capacity to private providers.

Privately owned utility companies also serve Seattle. These provide natural gas, district steam, and communications infrastructure and services. Additionally, various companies operate wireless communications facilities such as television, radio, and cellular phone towers and antennas. As the regulator of the public right-of-way, the City has limited control of private utilities. However, its agreements with cable companies do help ensure technical quality, protect customer rights, and support public services.

As Seattle continues to grow over the coming years, the existing utilities infrastructure is well poised to accommodate new buildings, although some development strategies and construction modifications may be required to bring services to individual lots. With proper maintenance and strategic planning, the existing infrastructure will also be able to support this Plan's broader goals of sustainability, economic efficiency, and equitable service access for all Seattleites. The **Utilities Appendix** contains information about the Seattle City Light and Seattle Public Utilities systems, as well as about privately owned utilities providing natural gas, district steam, and other energy, and communications services.

The utilities system will need to address historic conditions and respond to changing needs, technologies, and other factors in order to thrive over the next twenty years. The electrical system will have to increase capacity and become more reliable in order to adapt to emerging technologies such as local solar energy production and electric vehicles, while continuing to address climate change and maintaining a significant distribution system. The drinking water, drainage, and sewer systems will have to respond to new goals and regulatory mandates for water quality, as well as prepare for the impacts of a changing climate. At the same time, the drainage and wastewater utilities need to make updates to older systems that have produced combined sewer overflows and degraded creeks. The communications systems will need to grow to continue to address City, business, resident, education, health, service sector, and mobile communication needs.

Future investments will need to help the City address race and social equity. Seattle must ensure that the burdens and benefits of high-quality utilities infrastructure are distributed equitably throughout the city. Future infrastructure investments should help rectify existing environmental and service disparities while supporting the health and economic opportunity of underinvested communities. These areas of the city are disproportionately impacted by environmental contaminants or lack of service such as high-speed Internet availability.

A City survey shows disparities in access by race and ethnicity, with Hispanic or Latino households the least likely to have access to the Internet. Considering the importance of the Internet for receiving information, conducting business, and looking for work, having access to it is critical for people to participate in the economic life of the community.

Percentage of Seattle Households without Internet Access at Home

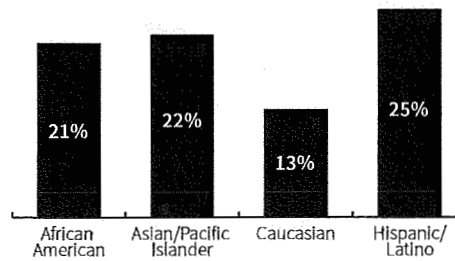

Source: Community Technology Survey 2015

The Utilities element of this Plan outlines goals and policies that will guide City decisions about providing and updating services. It also addresses emerging issues that utilities face. An inventory of existing infrastructure as well as the forecasted future needs for City-owned utilities are discussed in **this element's appendix**. The capital programs planned over the next six years are included in the City's most recently adopted Capital Improvement Program (CIP). Though this element focuses on how the City operates its own utilities, it also discusses how the City influences non-City utilities, such as communications, natural gas, and district steam.

Service Delivery

Discussion

Utilities providers must plan strategically to invest in maintaining and improving service delivery within finite physical and financial resources. Decisions we make today will have long-term implications for our ability to serve a changing population. This section describes the overarching goals and policies that apply to all aspects of service delivery.

GOAL

- U G1** Provide safe, reliable, and affordable utility services that are consistent with the City's aims of environmental stewardship, race and social equity, economic opportunity, and the protection of public health.

POLICIES

- U 1.1** Provide equitable levels of service by accounting for existing community conditions, considering how decisions will impact varied geographic and socioeconomic groups, and making service equity a criterion in decision-making.

- U 1.2** Coordinate planning, programs, and projects for City utilities with those of other City departments to lower costs, improve outcomes, and limit construction and operational impacts.
- U 1.3** Strive to develop a resilient utility system where planning and investment decisions account for changing conditions, such as climate change, technological changes, increased solar energy generation, and natural disasters.
- U 1.4** Support innovative approaches to service delivery, such as the development of distributed systems or joint ventures by City and non-City utilities, where they could further overall goals for utilities.
- U 1.5** Ensure that new private development provides adequate investments to maintain established utility service standards.
- U 1.6** Make utility services as affordable as possible through equitable delivery of utility discount programs and incentives.
- U 1.7** Leverage investments and agreements with private utilities and vendors to create training and living wage job opportunities, particularly for low-income and local residents.
- U 1.8** Support asset-management programs for the renewal and replacement of utility infrastructure.

Utility Resource Management

Discussion

Natural resources such as water, fuel, and materials, as well as hydropower capacity, are the basic inputs and outputs of the City's utilities. Issues related to energy supply, water supply and disposal, and waste management are essentially about how these resources are used, changed, and released. While the City has adequate existing capacity to provide electricity, drinking water, and waste disposal over the next twenty years, proper stewardship of these resources is vitally important for meeting the utilities' key goals. These goals include reducing impacts on the environment and preparing for climate change and a growing population.

This section describes how the utility providers manage energy supply, water supply and disposal, and materials to make the most effective use of these resources.

GOAL

- U G2** Conserve potable water, electricity, and material resources through the actions of the utilities and their customers.

POLICIES

- U 2.1** Use cost-effective demand management to meet the City’s utility resource needs, and support such practices by wholesale customers of City utilities.
- U 2.2** Consider short-term and long-term environmental and social impacts related to acquiring and using natural resources.
- U 2.3** Remain carbon neutral in the generation of electricity by relying first on energy efficiency, second on renewable resources, and third, when fossil fuel use is necessary, on offsetting the release of greenhouse gases.
- U 2.4** Strive to be carbon neutral in the delivery of drinking water, drainage, sewer, and solid waste services.
- U 2.5** Pursue the long-term goal of diverting most of the city’s solid waste away from landfills by increasing recycling, reducing consumption, and promoting products that are made to be reused, repaired, or recycled back into nature or the marketplace.
- U 2.6** Prevent pollutants and high water flows from damaging aquatic systems by preserving native vegetation, limiting impervious surfaces and stormwater runoff, reducing contamination of street runoff and stormwater, addressing combined sewer overflows, and minimizing illegal discharges into water bodies.
- U 2.7** Provide opportunities for marginalized populations to participate in conservation programs.

Utility Facility Siting and Design

Discussion

New substations, reservoirs, pump stations, green stormwater facilities, treatment facilities, and other utility infrastructure represent substantial long-term investments. As capacity increases and demand changes throughout the city, Seattle may need to add new utility facilities. Since the location and design of these facilities can have major impacts on their long-term cost and effectiveness, we must consider a wide range of perspectives in making these decisions. For example, siting and design decisions may impact efficiency, equity of service provision, environmental outcomes, and our ability to serve a growing population. We must also take existing conditions into account, such as the historical concentration of large polluting industries and utility operations in areas that also house low-income, racially diverse communities. By considering a range of desired outcomes for new facilities, the City can also design facilities that meet a broad range of utility goals.

The following policies address the location and design of Seattle’s utility facilities.

GOAL

- U G3** Site and design facilities so that they help to efficiently and equitably provide services to all Seattleites and provide value to the communities where they are located.

POLICIES

- U 3.1** Consider and budget for the potential operation and maintenance costs of new facilities when developing them.
- U 3.2** Discourage siting and design alternatives that may increase negative impacts, such as traffic, noise, and pollution, particularly in communities that already bear a disproportionate amount of these impacts.
- U 3.3** Apply consistent and equitable standards for the provision of community and customer amenities when they are needed to offset the impact of construction projects, ongoing operations, and facility maintenance practices.
- U 3.4** Build facilities that are models of environmental stewardship by including high levels of energy, water, and material efficiency, effectively managing stormwater on-site, prioritizing local and environmentally preferable products, and limiting waste.
- U 3.5** Consider opportunities for colocating facilities, allowing mixed-use development, or creating accessible open space when siting and designing utility facilities, provided doing so would still allow for safe and secure utility operations.
- U 3.6** Consider future climate conditions during siting and design, including changes to temperature, rainfall, and sea level, to help ensure capital facilities function properly as intended over their planned life cycle.
- U 3.7** Consider the disproportionate impacts of climate change on communities of color and lower-income communities when prioritizing projects.

Coordination within the Right-of-Way

Discussion

Above, below, and on the ground, Seattle's roads, paths, and other right-of-way spaces contain a vast array of utility infrastructure. Pipes, conduits, wires, poles, service vaults, storage tanks, pollution-control structures, streetlights, gutters, swales, and infiltration facilities are carefully integrated into the city's overall landscape. Due to limited space, however, the way these facilities are placed and maintained must be carefully managed. The City must work to minimize conflicts between the utilities and other uses of the right-of-way, as well as to make sure that infrastructure investments are well maintained.

At the same time, new investments in these facilities—particularly projects that result in opening the pavement—also provide opportunities to improve a variety of existing facilities and meet multiple objectives. Consequently, the City should look for opportunities to share costs, undertake joint projects, or otherwise consider the goals of other departments when undertaking projects in the right-of-way.

GOAL

- U G4** Coordinate right-of-way activities among departments to meet transmission, distribution, and conveyance goals; to minimize the costs of infrastructure investment and maintenance; to manage stormwater; and to support other uses such as transportation, trees, and public space.

POLICIES

- U 4.1** Engage departments in early coordination and collaboration on transportation and utility projects in the right-of-way to avoid space conflicts, identify joint project opportunities, and minimize life-cycle costs across all City departments.
- U 4.2** Coordinate construction to limit cost and public inconvenience caused by road and right-of-way disruption.

Non-City Utilities

Discussion

There are a few ways the City generally works with non-City utilities, such as natural gas, district steam, and communications providers. The City reviews street use permits, coordinates projects, creates development and leasing policies, and executes franchise agreements or programmatic term permits. These relationships offer opportunities to improve service provision for customers, reduce the impacts of construction, and encourage non-City utilities to work toward City goals. Specific policies about the location of communications facilities are included in the Land Use element. The following policies address the operation of non-City utilities in Seattle generally.

GOAL

- U G5** Work with non-City utilities to promote the City's overall goals for utility service and coordinated construction within the right-of-way.

POLICIES

- U 5.1** Provide affected non-City utilities with timely and effective notices of planned road and right-of-way trenching, maintenance, and upgrade activities.
- U 5.2** Support competition among private providers by giving equitable access to the right-of-way for all data and telecommunications service providers to reach their customers.
- U 5.3** Encourage improvements in the communications system to achieve the following:
- Universal and affordable access for residents, businesses, and institutions within Seattle, particularly for marginalized populations
 - Customer options and competitive pricing
 - Consumer privacy, system security, and reliability
 - State-of-the-art services

Economic Development



Introduction

Seattle is the vital center of the Puget Sound economy and is a leading West Coast hub. Over the past fifty years, Seattle's economy has successfully transitioned its focus from timber, shipping, aerospace, and the military to more diverse sources that reflect traditional industry, emerging technology, and innovation-driven sectors. After a challenging decade that included the Nisqually earthquake, impacts from September 11, and the Great Recession, Seattle's economy recovered more quickly than that of many other cities. By 2013, Seattle had regained the 35,000 jobs lost during the recession, pushing unemployment below 5 percent for the first time since 2008. The highest job growth occurred in the services sector. Although the number of jobs in the city's two manufacturing/industrial centers has shrunk, they still account for 16 percent of all jobs in the city.

The City is anticipating an additional 115,000 jobs over the next twenty years. The urban village strategy identifies the geographic areas best suited for job growth—urban centers,

urban villages, and manufacturing/industrial centers. Some businesses and jobs are best suited to the mixed-use, walkable urban centers and villages. Others require unique features, services, and targeted land uses that fit best in manufacturing/industrial centers. Seattle must balance these varied demands in order to sustain existing businesses while also anticipating the needs of emerging businesses and industries.

The purpose of the Economic Development element of this Plan is to provide direction about how to maintain and grow Seattle's vibrant, diverse, and increasingly global economy to benefit individuals across income levels, as well as business, industry, and the city's diverse communities. As Seattle grows, the City will strive to reduce income inequities and to identify and address policies that contribute to or create inequity.

Seattle is an attractive place to live, giving it a competitive advantage. Seattle's beautiful physical setting, thriving cultural scene, walkable neighborhoods, diverse restaurants, unique shopping, access to nature, and historic locations generate direct economic benefits to residents. These attributes also contribute to the high-quality of life that draws businesses, people, and tourists to the city. Seattle also benefits from the way leaders from public and private sectors work together to encourage innovation and to support business formation, retention, and expansion.

However, not all residents have shared in Seattle's economic prosperity. Communities of color, for example, have higher rates of unemployment, lower incomes, and less education when compared to the city as a whole. Unemployment rates in Seattle have remained higher for people of color than for whites in the wake of the Great Recession. The 2011 to 2013 American Community Survey found that close to 14 percent of African American residents in Seattle were unemployed during that time span. This is over twice the unemployment rate for whites. More recent data shows lower overall unemployment in Seattle, and national statistics show that unemployment among African Americans is also declining. However, current data about African American unemployment in Seattle is not available.

Widening gaps in income and opportunity hurt Seattle's future prospects. Closing these gaps will require, among other things, more training and education for the city's marginalized populations. Improving education and job skills within these communities will reduce the need to import workers from elsewhere. Community-led economic development in underinvested neighborhoods can spur small-business start-up and growth. It can also provide economic opportunities for current resident, immigrant, and refugee entrepreneurs. Shared prosperity is not just about what low-income communities need—it is about what they can contribute.

Unemployment Rates for Seattle Residents Age 16 and Over

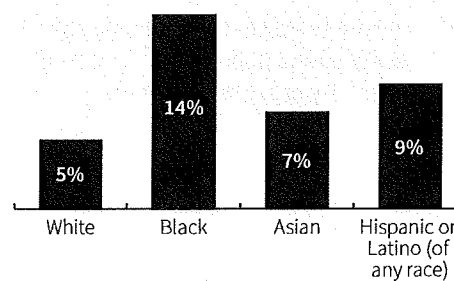

Source: 2011–2013 ACS, US Census Bureau

The **Land Use Appendix** shows the number of jobs in each urban center and urban village.

Commercial Districts

Discussion

Seattle enjoys an attractive, flourishing Downtown core that houses about 30 percent of all jobs within the city. Outside of Downtown, a network of long-standing, distinctive, walkable places (known as hub urban villages and residential urban villages) exists. This is where small businesses thrive, communities come together, and many local jobs are created. About 12 percent of Seattle’s jobs are located in these areas.

GOAL

ED G1 Encourage vibrant commercial districts in urban centers and villages.

POLICIES

- ED 1.1** Enhance the Downtown core as the economic center of the city and the region, and strengthen its appeal as home to many of Seattle’s vital professional service firms, high technology companies, and regional retailers, as well as cultural, historic, entertainment, convention, and tourist facilities.
- ED 1.2** Promote a comprehensive approach to strengthening neighborhood business districts through organization; marketing; business and retail development; and clean, safe, walkable, and attractive environments.
- ED 1.3** Prioritize assistance to commercial districts in areas of lower economic opportunity.
- ED 1.4** Enrich the vibrancy of neighborhood business districts through the integration of design, public art, public space, historic preservation, and cultural spaces and programming.
- ED 1.5** Support independently owned and operated retail and restaurants in commercial districts to reinforce local neighborhood and cultural identity and strengthen the local economy.
- ED 1.6** Pursue strategies for community development that help meet the needs of marginalized populations in multicultural business districts, where small businesses are at risk of displacement due to increasing costs.

Industry Clusters

Discussion

Seattle's best prospects for future economic growth are in its key "industry clusters"—concentrated networks of interdependent firms in a defined geographic area that share common markets, technologies, and a need for skilled workers. Examples of Seattle's industry clusters include manufacturing, maritime, biotech and life sciences, global health and health care, clean technology, information technology, tourism, and film and music.

These clusters certainly help the associated businesses, which benefit from the rapid exchange of information, leading to innovative and efficient operations. The clusters are also an asset to the overall economy. Generally, businesses in industry clusters pay higher than average wages, bring new capital into the economy, are environmentally minded, and add variety to the economic base. By identifying key sectors of the economy in which Seattle has a competitive advantage, the City can better shape industry clusters and help achieve a vibrant, balanced, and diversified economy that benefits individuals across all income levels.

GOAL

ED G2 Enhance strategic industry clusters that build on Seattle's competitive advantages.

POLICIES

- ED 2.1** Improve linkages between industry clusters and research institutions, hospitals, educational institutions, and other technology-based businesses.
- ED 2.2** Encourage collaboration among businesses within and across industry clusters in the areas of marketing, research, capital and talent acquisition, job training, and expansion of highly skilled jobs.
- ED 2.3** Improve the ability of industry clusters to transfer technology in cooperation with other jurisdictions and with major education and research institutions.
- ED 2.4** Encourage industry clusters to have workforces that are representative of Seattle's racial and socioeconomic groups.
- ED 2.5** Promote coordination of economic development and community development among City departments, as well as with all levels of government, the business community, and nonprofits, to strengthen industry clusters.

Business Climate

Discussion

A city's business climate is determined by how well it attracts and sustains businesses. The external factors that shape this climate include quality of the workforce, taxes, regulations, incentives, and other government policies and investments, as well as overall quality of life in the city. Seattle is renowned for its mild climate, extraordinary access to recreation and natural resources, and diverse cultural offerings. Seattle's collaborative culture is another economic advantage. However, some aspects of Seattle's business climate pose challenges for business, such as complex development regulations, earthquake risk, and underfunded transportation and education systems.

GOAL

ED G3 Encourage a business climate that supports new investment, job creation, and resilience and that values cultural diversity and inclusion.

POLICIES

ED 3.1 Promote the expansion of international trade within Seattle and throughout the region.

ED 3.2 Strive to make the business climate more competitive through use of transparent and predictable regulations, efficient approval processes, and reasonable taxes, fees, and utility rates.

ED 3.3 Foster partnerships between the public and private sectors to improve business climate.

ED 3.4 Improve coordination of information and services between city, county, regional, state, and federal agencies to develop and implement economic-development policies and programs.

ED 3.5 Address the needs of culturally relevant businesses most vulnerable to redevelopment pressure and displacement.

ED 3.6 Consider the needs and priorities for long-term economic recovery in postdisaster recovery and mitigation planning.

ED 3.7 Evaluate taxes, regulations, incentives, and other government policies and investments to determine the benefits and burdens for marginalized populations.

Workforce

Discussion

The success of industry clusters depends on a skilled and competitive workforce. However, many employers have noted a lack of qualified job applicants for some positions in Seattle. This includes a variety of industries that have been unable to find enough local college graduates to fill jobs in certain engineering, computer, and life science fields, as well as traditional industries looking to replace an aging highly skilled workforce. As a result, many employers look to attract talent from elsewhere. Better education and training of local workers can connect displaced workers, disadvantaged youth, and recent immigrants to highly skilled job opportunities.

GOAL

ED G4 Maintain a highly trained and well-educated local workforce that effectively competes for meaningful and productive employment, earns a living wage, meets the needs of business, and increases opportunities for social mobility.

POLICIES

- ED 4.1** Create a coalition of business, labor, civic and social service agencies, libraries, and educational institutions that can develop and expand education and training programs targeted to the needs of business, especially for high-demand science, technology, engineering, and mathematics skills.
- ED 4.2** Increase job training, internships, and job placement to overcome barriers to employment and to achieve greater racial and social inclusion in the workforce.
- ED 4.3** Encourage all businesses to pay a living wage, provide necessary employment benefits, and hire local residents.
- ED 4.4** Explore opportunities to coordinate community-development activities with place-based workforce-development opportunities in communities with high unemployment.
- ED 4.5** Promote programs aimed at reducing unemployment among people of color in Seattle.
- ED 4.6** Support efforts that connect youth to internships and other education and career opportunities.

Entrepreneurial and Small Business Development

Discussion

Our city is home to major national companies such as Trident Seafoods, Filson, Cascade Designs, Starbucks, Amazon, Tableau, and Nordstrom, to name a few. However, most Seattle businesses are much smaller and have fewer than ten employees. Sectors with an especially high proportion of small businesses include construction, wholesale trade, manufacturing, retail and related services, and increasingly, start-ups in technology and other creative industries. In addition, food growers, processors, and distributors are a quickly expanding presence within the local economy.

As technological advances continue to lower the cost of starting new businesses, the rate of new entrepreneurs will rise. In addition to attracting new types of businesses, we must redouble our efforts to retain the small, culturally diverse businesses that support equally diverse communities.

GOAL

ED G5 Strengthen the entrepreneurial environment for start-ups and small businesses.

POLICIES

- ED 5.1** Encourage institutions of higher education toward commercialization of research innovations to fuel the growth of start-ups.
- ED 5.2** Enhance arts and culture activities in order to attract creative-class workers, living wage employers, and tourists to Seattle, as well as to enrich our overall culture of innovation.
- ED 5.3** Expand the network for technology and innovation entrepreneurs to learn about services and jobs, build relationships, and find resources—all of which will help enable their businesses to flourish.
- ED 5.4** Establish incentives to encourage property owners and building owners to offer affordable spaces for start-ups and small businesses.
- ED 5.5** Reduce barriers to business start-up and entrepreneurship, especially barriers that confront marginalized populations, immigrants, and refugees.
- ED 5.6** Promote the growth of local small businesses.

Environment



Introduction

Choices the City makes about how to grow and operate deeply affect the health and sustainability of our natural environment. Over the next twenty years, the City has an amazing opportunity to act to protect the climate and restore the natural environment. We can improve human health, make vibrant green spaces, create habitat for wildlife, generate jobs, and reduce the burdens on the environment. As a city of outstanding creativity and appreciation of the natural environment, Seattle can set an example that inspires others and leads to improvements beyond the City's actions by demonstrating what a strong, climate-friendly economy can look like. The City can make investments to restore green spaces and creeks and develop a twenty-first-century transportation system that integrates old (walking, biking, cars) and new (light rail, car sharing) approaches. Measures like these can help a growing region accommodate people and jobs in urban areas, create livable communities, and reduce the impacts of sprawl.

Seattle is committed to understanding how its decisions impact different individuals and communities. To fulfill its vision for race and social equity, the City must ensure that environmental benefits are equitably distributed and burdens are minimized and equitably shared.

Exposure to indoor and outdoor pollutants increases the risks of hospitalization for people with asthma. There are large racial, income, and geographic disparities in the hospitalization rates for asthma. Within Seattle, Beacon Hill, Southeast Seattle, Downtown, and the Central Area have the highest rates of hospitalization for asthma, and these are among the highest rates in King County.

Adult Asthma Hospitalizations
by Zip Code 2008 to 2012
Average Annual Rate per 100,000 Adults

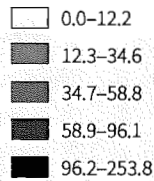

Source: Public Health – Seattle & King County, Community Health Indicators Project.



The City is actively working to reduce future greenhouse gas emissions. But because of past emissions we know that some amount of climate change is now inevitable. The City must learn to understand and adapt to these changes.

This element of the Plan contains goals and policies that are relevant to all other elements of this Plan. And other elements also touch on environmental policies specific to those topics. For example, the Plan’s Land Use element considers policies that regulate development near environmentally critical areas, and the Transportation element addresses how various types of transit could impact or improve outcomes for the environment.

Land

Discussion

Seattle’s growth and identity have been profoundly shaped by its stunning natural landscape. The first native and European settlers were drawn here by the area’s natural bounty as well as the economic value of the land for logging and resource extraction. Today, our city has become a magnet for those attracted to its lush landscapes and access to the exceptional natural places in the region. Over time, our relationship and interaction with the land has changed dramatically, but its critical importance in our lives remains.

Although the region looks very different than it did when European settlers first arrived 150 years ago, Seattle’s trees, vegetation, and soils still make up a vitally important system that

manages water runoff, cleans the air, mitigates greenhouse gas emissions and impacts, improves human health, and reduces the heat island effect. This natural system also provides wildlife habitats, supports livable neighborhoods, and is integral to the essential character of the Emerald City.

GOAL

EN G1 Foster healthy trees, vegetation, and soils to improve human health, provide wildlife habitats, improve drainage, give residents across the city access to nature, provide fresh food, and increase the quality of life for all Seattleites.

POLICIES

- EN 1.1** Seek to achieve an urban forest that contains a thriving and sustainable mix of tree species and ages, and that creates a contiguous and healthy ecosystem that is valued and cared for by the City and all Seattleites as an essential environmental, economic, and community asset.
- EN 1.2** Strive to increase citywide tree canopy coverage to 30 percent by 2037 and to 40 percent over time.
- EN 1.3** Use trees, vegetation, green stormwater infrastructure, amended soil, green roofs, and other low-impact development features to meet drainage needs and reduce the impacts of development.
- EN 1.4** Increase the amount of permeable surface by reducing hardscape surfaces where possible and maximizing the use of permeable paving elsewhere.
- EN 1.5** Promote sustainable management of public and private open spaces, trees, and vegetation by preserving or planting native and naturalized vegetation, removing invasive plants, improving soil health, using integrated pest management, and engaging the community in long-term stewardship activities.
- EN 1.6** Strive to manage seven hundred million gallons of stormwater runoff each year with green stormwater infrastructure by 2025.
- EN 1.7** Promote the care and retention of trees and groups of trees that enhance Seattle's historical, cultural, recreational, environmental, and aesthetic character.
- EN 1.8** Encourage gardening and food production by residents as a way to make fresh, healthy food available in the city.

Water

Discussion

Seattle is a city of water. Puget Sound, Lake Washington, Lake Union, the Lake Washington Ship Canal, the Duwamish River, Green Lake, urban creeks, and small lakes all enhance the quality of life for the people and wildlife that live here. Four species of salmon—including the threatened Chinook salmon—call this area home, as do resident trout, blue herons, bald eagles, and a variety of other water-dependent species. Seattle’s major waterways bustle with business and recreational opportunities, while also supporting one of the premier industrial seaports on the West Coast. Moreover, Seattle’s aquatic areas give residents the chance to enjoy and experience nature close to home.

Yet despite their integral place in the local culture, landscape, and economy, Seattle’s aquatic resources have been significantly degraded as a result of urban growth. A six-mile stretch of the Duwamish River is now a federal Superfund site. Over 90 percent of Seattle’s 146 miles of shoreline have been modified and now lack natural connections to the water. The city’s creeks have seen stormwater flows equivalent to some rivers. Fish in local waters contain high amounts of mercury and PCBs, and some of our coho salmon are dying before they can reach Seattle streams to spawn. Yet even these resources, polluted as they may be, have amazing vitality and resilience. They have the potential to become even greater assets to Seattleites.

GOAL

EN G2 Foster healthy aquatic systems, including Puget Sound, lakes, creeks, rivers, and the associated shorelines, to provide a high-quality of life in Seattle for all its residents and a valuable habitat for fish and wildlife.

POLICIES

- EN 2.1** Protect and improve water and sediment quality by controlling pollution sources and treating stormwater through best management practices.
- EN 2.2** Reduce combined sewer overflows by reducing stormwater inflows and increasing storage in combined system areas.
- EN 2.3** Seek to clean up existing contaminated sediments.
- EN 2.4** Limit the use of chemicals that have negative impacts on aquatic or human health, especially on City-owned property or rights-of-way.

- EN 2.5** Manage flows in creeks to support a variety of aquatic life and to control flooding and property damage caused by unregulated flows.
- EN 2.6** Promote quality wildlife habitats in Seattle's waterways by protecting and improving migratory fish passageways, spawning grounds, wetlands, estuaries, and river mouths.

Climate

Discussion

Climate change is a challenge of sobering magnitude and urgency. To confront it, Seattle will need to draw on its own capacity for resilience and innovation. The ways we use our land, design our buildings, and get around the city significantly impact the amount of energy we use and the greenhouse gas emissions we produce. One of the key ways the City will work toward its climate goals is through the urban village strategy. Cars and trucks are Seattle's largest source of greenhouse gas emissions, and concentrating new housing and jobs in urban centers and urban villages near frequent transit service will reduce motorized-vehicle use in the city.

While concerted efforts to decrease greenhouse gas emissions can help address climate change, emissions from past decades and ongoing emissions will continue to affect the global climate. The most significant changes to the Pacific Northwest will be to temperature, precipitation, and sea level. The projected flooding, heat waves, and extreme high tides are not new challenges in Seattle, and the City has strategies for responding to them. However, climate change will shift the frequency, intensity, and timing of these events. If we don't prepare for these types of events now, they will significantly impact the city's health, infrastructure, and economy.

Marginalized populations are at greater risk from the impacts of climate change because they have the fewest resources to respond to changing conditions. Taking action to reduce the impacts of climate change and foster resilience in these communities is critical, as will be supporting their recovery after extreme events.

GOAL

- EN G3** Reduce Seattle's greenhouse gas emissions by 58 percent from 2008 levels by 2030, and become carbon neutral by 2050.

POLICIES

- EN 3.1** Expand transit, walking, bicycling, and shared-transportation infrastructure and services to provide safe and effective options for getting around that produce low or zero emissions.
- EN 3.2** Aspire to meet the growing demand for conveniently located homes and businesses in pedestrian-friendly neighborhoods where residents can walk to a variety of recreation and service offerings.
- EN 3.3** Implement innovative policies, such as road pricing and parking management, that better reflect the true cost of driving and therefore lead to less automobile use, while employing strategies that mitigate impacts on low-income residents.
- EN 3.4** Encourage energy efficiency and the use of low-carbon energy sources, such as waste heat and renewables, in both existing and new buildings.
- EN 3.5** Reduce the amount of waste generated while at the same time increasing the amount of waste that is recycled and composted.
- EN 3.6** Reduce the emissions associated with the life cycle of goods and services by encouraging the use of durable, local products and recycled-content or reused materials, and recycling at the end of products' lives.
- EN 3.7** Support a food system that encourages consumption of local foods and healthy foods with a low carbon footprint, reduces food waste, and fosters composting.

GOAL

- EN G4** Prepare for the likely impacts of climate change, including changing rain patterns, increased temperatures and heat events, shifting habitats, more intense storms, and rising sea level.

POLICIES

- EN 4.1** Consider projected climate impacts when developing plans or designing and siting infrastructure, in order to maximize the function and longevity of infrastructure investments, while also limiting impacts on marginalized populations and fostering resilient social and natural systems.
- EN 4.2** Prioritize actions that reduce risk and enhance resilience in populations nearest the likely impacts of climate change, including especially marginalized populations and seniors, since these groups often have the fewest resources to respond to changing conditions and therefore may be more severely impacted.

Environmental Justice

Discussion

Marginalized populations are more likely than other Seattle residents to live close to pollution sources. This is because rents are often lower in these areas. However, living in those places could expose those populations to potential negative effects of the nearby pollution. Seattle wants to make the city a safe and healthy city for all people who live here.

GOAL

EN G5 Seek to ensure that environmental benefits are equitably distributed and environmental burdens are minimized and equitably shared by all Seattleites.

POLICIES

- EN 5.1** Consider the cost and benefits of policy and investment options on different communities, including the cost of compliance as well as outcomes.
- EN 5.2** Prioritize investments, policies, and programs that address existing disparities in the distribution of environmental burdens and benefits.
- EN 5.3** Prioritize strategies with cobenefits that support other equity goals such as promoting living wage jobs or enhancing social connectedness.
- EN 5.4** Assess facilities and services periodically to determine the environmental impacts they may be having on marginalized populations, and identify ways to mitigate those impacts.

Parks and Open Space



Introduction

Parks and open space help make Seattle a great place to live, play, and raise families. These places contribute not only to the city's environmental health but also to the physical and mental health of its residents. Access to open space can benefit individuals by giving them places to exercise their bodies and refresh their minds. Open spaces also provide valuable wildlife and vegetation habitat that might otherwise be scarce in the city.

The City-owned park and recreation system comprises about 11 percent of the total city land area. It includes gardens, community centers, boating facilities, and environmental education centers. From the magnificent views off the bluffs of Discovery Park to the tree-lined boulevard system and intimate pocket parks, these areas provide opportunities for residents and visitors to relax, enjoy competitive games, exercise, or meet with friends and neighbors.

Developed parks are not the only sources of open space that people enjoy in the city. There are also open spaces and recreation opportunities located in public rights-of-way, such as along Cheasty and Ravenna Boulevards or in Bell Street Park. Off-road bike trails, including the Burke-Gilman Trail and Alki Beach Park, offer other types of active recreation. An extensive system of P-Patches and community gardens throughout the city offer gardening spaces for residents to grow their own fruits, vegetables, and flowers. Seattle Center, which itself is not part of the City parks system, is nevertheless a unique urban amenity that offers both open space and a wide variety of cultural activities.

Other agencies also provide open spaces in the city. These include fields and playgrounds at public and private schools, areas such as the federal Chittenden Locks, several waterfront access points provided by the Port of Seattle, and the open spaces on several college and university campuses. Numerous private developments have made plazas and other open areas available to the public, such as Waterfall Garden Park in Pioneer Square.

In addition to the areas enjoyed by the public, there are many private open spaces in the city. These areas—such as yards in single-family and multifamily zones—also provide light, air, and breathing room that benefit everyone in the city.

Puget Sound and the city's lakes provide another form of open space. These wide stretches of water are open to the sky and offer visual relief from the urban environment, as well as visual connections to other areas of the city and region.

In 2014 voters in Seattle approved the formation of the Seattle Park District. This district provides a new taxing authority and funding source for the maintenance and improvement of City parks, as well as for programs aimed at serving historically underserved residents and communities. Some of the ways the City obtains new parkland are by using state funds, acquiring surplus federal land, establishing requirements for new development projects, providing incentives for developers, and creatively using public rights-of-way.

Access to Open Space

Discussion

The city has a robust citywide park and open space system. These open spaces are available for use by all. However, the City continues to look for ways to improve this system. Seattle is already very developed, so there aren't many opportunities to find new land for open spaces. Creating the system that we desire—and one that will serve the growing city—will require new strategies, including some that will increase the capacity of existing parks. We will have to find the right balance between active and passive recreational activities throughout the park

system, build better access through the City’s transportation planning, and provide access to open space and recreational programming as part of public and private development.

Public health studies indicate that proximity to parks is associated with greater levels of physical activity as well as increased park use. Open spaces in Seattle are well distributed and available throughout the city. However, a recent study found that lower-income people are less likely to participate in physical activity than people with higher incomes, as shown on the accompanying table.

Seattle Residents’ Participation in Recreational Activities

Percentage of residents who participate

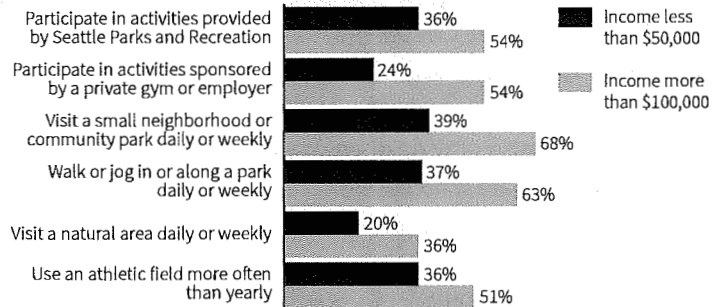

Source: City of Seattle Parks Legacy Plan Survey, conducted in 2012

This section addresses the design and distribution of our citywide park and open space system, including how new parks and open space are acquired and developed. The Seattle Parks and Recreation Department’s Development Plan also contains specific goals for Seattle’s parks, open space, and facilities such as community centers, athletic fields, and playgrounds.

GOAL

- P G1 Provide a variety of outdoor and indoor spaces throughout the city for all people to play, learn, contemplate, and build community.

POLICIES

- P 1.1 Continue to expand the City’s park holdings and open space opportunities, with special emphasis on serving urban centers and urban villages that are home to marginalized populations and areas that have been traditionally underserved.
- P 1.2 Provide a variety of parks and open space to serve the city’s growing population consistent with the priorities and level-of-service standards identified in the City’s Park Development Plan.
- P 1.3 Provide urban trails, green streets, and boulevards in public rights-of-way as recreation and transportation options and as ways to connect open spaces and parks to each other, to urban centers and villages, and to the regional open space system.
- P 1.4 Reduce health disparities by making investments that provide access to open space and recreation activities for marginalized communities.

- P 1.5 Make rights-of-way available on a temporary basis to provide space for community events, such as street fairs, farmers' markets, or neighborhood celebrations.
- P 1.6 Provide areas to preserve important natural or ecological features in public ownership, and allow people access to these spaces.
- P 1.7 Provide public access to shorelines by using street ends, regulation, or acquisition.
- P 1.8 Encourage or require private developers to incorporate on-site publicly accessible open space or to provide appropriate recreation opportunities for building tenants within new developments.
- P 1.9 Consider the use of open space impact fees to help fund open space system improvements that will serve the expected growth.
- P 1.10 Use cooperative agreements with Seattle Public Schools and other public agencies to provide access to open spaces they control.
- P 1.11 Create healthy places for children and adults to play, as well as areas for more passive strolling, viewing, and picnicking.
- P 1.12 Use investments in park facilities and programs to reduce health disparities by providing access to open space and recreational activities for all Seattle residents.
- P 1.13 Design open spaces that protect the natural environment and provide light, air, and visual relief within the built environment.
- P 1.14 Make the most of the limited available land by developing parks and open spaces so that they can accommodate a variety of active and passive recreational uses.
- P 1.15 Consider access by transit, bicycle, and foot when acquiring new park facilities or improving existing ones.

Parks and Recreation Activities

Discussion

Seattle Parks and Recreation provides programs and facilities that let people play, learn, and lead healthy, active lives. People gather, take classes, exercise, and play sports at community centers, pools, and lakes. Other City facilities, such as golf courses, boating centers, and tennis courts, offer additional opportunities for recreation. Seattle Parks and Recreation offers programs for teens and classes that provide opportunities for lifelong learning and recreation options for those with disabilities.

GOAL

- P G2 Continue to provide opportunities for all people across Seattle to participate in a variety of recreational activities.

POLICIES

- P 2.1** Consider the use of open space impact fees to help fund recreational facility system improvements that will serve the expected growth.
- P 2.2** Develop a long-term strategic plan that accounts for citywide and neighborhood demographics, as well as the demand for various active and passive recreation activities.
- P 2.3** Establish partnerships with public and private organizations to supplement programming that supports residents' needs and interests.
- P 2.4** Develop activities at community centers based on the specific needs of each community they serve and make them neighborhood focal points where people can enhance their individual health and well-being and strengthen a sense of community.
- P 2.5** Promote the use of open spaces and park facilities in the city for events that celebrate our history and the many cultures of our community.
- P 2.6** Provide recreation and social programs that allow older adults to remain healthy and actively involved in their community.
- P 2.7** Provide athletic fields that can serve as places where people of diverse ages, backgrounds, and interests can engage in a variety of sports.
- P 2.8** Offer fun and safe water experiences through a diverse range of healthy and accessible aquatic programs at outdoor and indoor venues throughout the city.
- P 2.9** Provide welcoming, accessible, and affordable recreation and social programs for people with disabilities and their families.
- P 2.10** Engage teens with activities that help them to build their identities and to acquire skills that will lead to healthy and productive lives.
- P 2.11** Develop programs that foster awareness and appreciation of nature from the neighborhood scale to the regional scale and provide activities for residents to help protect or restore the environment.
- P 2.12** Provide programs that are culturally responsive, accessible, welcoming, and affordable to communities of color and to immigrant and refugee communities.
- P 2.13** Provide welcoming, accessible, and affordable recreation and social programs for LGBTQ youth and adults.
- P 2.14** Develop partnerships with organizations that consider race and social justice to be fundamental to their operations and business practices.

Maintaining Park and Recreation Facilities

Discussion

The City's park system makes up a significant amount of the city's land, and that land contains many types of buildings, swimming pools, trails, landscaped and natural areas, and urban forests. Keeping these facilities safe and enjoyable requires constant attention.

GOAL

- P G3** Manage the City's park and recreation facilities to provide safe and welcoming places.

POLICIES

- P 3.1** Implement capital improvements that are driven by a long-term programmatic strategic plan.
- P 3.2** Maintain the long-term viability of park and recreation facilities by regularly addressing major maintenance needs.
- P 3.3** Look for innovative ways to approach construction and major maintenance activities to limit water and energy use and to maximize environmental sustainability.
- P 3.4** Enhance wildlife habitat by restoring forests and expanding the tree canopy on City-owned land.
- P 3.5** Protect habitat and wildlife areas through education, interpretation, and wildlife-management programs.
- P 3.6** Increase access to public land by assessing, managing, and cleaning up contaminated sites.
- P 3.7** Preserve and reclaim park property for public use and benefit, and ensure continued access to parkland for the growing population.
- P 3.8** Leverage capital and program investments and agreements with private vendors to provide training, apprenticeships, youth employment, and living wage job opportunities for marginalized populations.

Major Open Space Attractions

Discussion

Some of the facilities maintained by Seattle Parks and Recreation and certain other open spaces in the city attract many visitors from outside their immediate neighborhoods. Washington Park Arboretum, Woodland Park Zoo, Kubota Garden, Seattle Aquarium, Magnuson Park, the Olympic Sculpture Park, and Seattle Center are examples of locations that offer natural and cultural attractions and bring users from across the region into Seattle's neighborhoods.

GOAL

- P G4** Plan and maintain regional parks and facilities to accommodate the people who will want to visit them, while respecting the facilities' neighbors.

POLICIES

- P 4.1** Develop plans for regional and special-use parks to take advantage of unique natural and cultural features in the city, enhance visitors' experiences, and nurture partnerships with other public agencies and private organizations.
- P 4.2** Design parks and program activities in Downtown in ways that create a welcoming and safe environment.
- P 4.3** Recognize that visitors to major regional attractions can impact the neighborhoods surrounding those facilities, and look for ways to limit those impacts, including through enhanced walking, biking, and transit connections.
- P 4.4** Look for innovative ways to conduct construction and major maintenance of park facilities that will provide training, apprenticeships, youth employment, and living wage opportunities for marginalized populations.

Arts and Culture



Introduction

Arts and culture are part of the city's rich history. They will play a major role in Seattle's future as a vital, thriving city. As in any dynamic urban area, the city's arts and culture contribute to its identity and sense of place. This aspect of the city enriches the lives of its residents and inspires their creativity and innovation.

Arts and culture extend to all aspects of civic life. For instance, the arts can teach students valuable skills—like critical thinking and observation—that can also be applied in math, science, and reading. These skills help students succeed in school and in the workplace. The city's arts and culture scene creates jobs and attracts visitors, customers, and highly skilled workers to the area. At the same time, arts and culture play an important social role by nurturing a welcoming and diverse urban community. Arts and culture can expand perspectives and encourage empathy toward people with different experiences. They help cultivate a greater appreciation and understanding of diverse cultures across Seattle.

A 2012 study by Seattle Public Schools found large disparities in access to arts education among its students. The study measured the number of students taking at least six arts classes during their middle school and high school years. The students who took fewer than six art classes were

- *from low-household incomes,*
- *non-native English speakers, and/or*
- *African American, American Indian/Alaska Native, and Hispanic.*

The Arts and Culture element of this Plan outlines goals and policies related to the arts, cultural institutions, and historic preservation. Together these aspects of the city encompass a broad range of people, activities, spaces, and levels of involvement. The City is committed to supporting the arts and to offering great experiences for art consumers and creators of art across Seattle. Making arts and culture accessible to all requires programs that represent Seattle's diversity. As Seattle grows, the City must make an extra effort to help everyone feel welcome within Seattle's arts and cultural environment.

Experiencing arts and culture should be fun and challenging. It should also be accessible so that it can be enjoyed regularly by all. There are so many ways to experience art. It can be created or observed or collaborated on. From tangible, physical objects, books, and digital works to experiences, gatherings, performances, and oral histories, the Seattle arts scene has many different points of entry. Cultural spaces are varied and can range from traditional theaters, galleries, and studios to schools, parks, libraries, and coffee shops.

Historic preservation recognizes and protects aspects of our shared cultural heritage—buildings, districts, and designed landscapes that link to Seattle's past. From the Native Americans who first established trading centers along the Duwamish River to the latest waves of newcomers from around the world, all have left their mark. Over time, Seattle has acquired historic features that have become part of the city's civic identity. Through the preservation of icons and historic locations such as the Space Needle, the Olmsted network of parks and boulevards, and Pioneer Square, the city can continue to celebrate its heritage and maintain its unique sense of place.

The benefits of historic preservation are not merely aesthetic. Preservation is integral to our economic-development planning, and it also enhances our city's identity as a center for tourism, itself an important source of local jobs. Preserving historic buildings can help incubate small businesses, revitalize commercial districts, and generate local jobs. Historic preservation promotes sustainability through the reuse, repair, and upgrading of existing built resources. Historic preservation policies are contained in the **Land Use element** of this Plan.

Arts and culture can revitalize historically underinvested communities, while helping them keep their culture as the city grows and changes. Investments in arts and culture can help preserve the cultural traditions and artistic expressions of existing communities, including communities of color, as well as those of newly arrived immigrants and refugees.

Public Art

Discussion

By integrating art into diverse public settings, Seattle has built on its reputation as a cultural center of innovation and creativity. Letting both visitors and locals alike encounter art in parks, libraries, and community centers—as well as on roadways, bridges, and other public venues—enriches people’s daily lives and gives voice to artists. The City’s public art collection includes more than four hundred permanently sited and integrated works and three thousand portable works. The collection will continue to grow through the City’s 1 Percent for Art program, which requires that 1 percent of the funds from eligible capital improvement projects be set aside for the commission, purchase, and installation of artworks in a variety of settings. To commission public art, the City uses a panel made up of artists and arts professionals, alongside community and City representatives. All public art is cared for through ongoing conservation, which includes inspections, major restorative work, and routine maintenance.

GOAL

AC G1 Strengthen the diversity of public art and expand the City’s collection of public artworks.

POLICIES

AC 1.1 Continue to set aside funding for new public art as part of capital improvement projects.

AC 1.2 Encourage the inclusion of artists early in the design of capital improvement projects.

AC 1.3 Prioritize locations for new public art where it is desired by the community, can be accommodated safely, and will be enjoyed by many people in locations throughout the city.

AC 1.4 Enhance the diversity of panelists and community representatives that are included in the public-art selection process.

AC 1.5 Strengthen the diversity of expression in public art to embrace a variety of artists, sites, disciplines, and media to fully reflect the cultural diversity of the city.

AC 1.6 Encourage public participation in the planning and implementation of public art projects.

Creative Economy

Discussion

Partnering with individual artists, as well as arts and cultural organizations, the City strives to offer all Seattleites a rich array of quality art opportunities while promoting a healthy and diverse cultural community. Encompassing a wide variety of arts and cultural businesses, ranging from nonprofit museums, symphonies, and theaters to for-profit film, architecture, and advertising companies, the creative economy also includes thousands of independent artists working in Seattle.

When supported, arts and culture can help drive the City's future economic growth. Arts companies and their employees stimulate innovation, playing an important role in building and sustaining economic vibrancy in Seattle. They employ a creative workforce, spend money locally, generate government revenue, and are a cornerstone of tourism. The arts are also an economic-development tool, creating neighborhoods where businesses want to operate and employees want to live. The creative economy also contributes to Seattle's high-quality of life, helping our city and region attract talent from across the globe. Encouraging creative economy activities in communities of color can provide pathways to new skills, jobs, and prosperity. In other words, the impact of the arts reaches far beyond aesthetics.

GOAL

AC G2 Enhance support for artists, creative professionals, and cultural organizations, allowing them to grow and mature.

POLICIES

- AC 2.1** Recognize and expand the economic impact of arts and culture.
- AC 2.2** Encourage collaboration across the spectrum of traditional and creative economy businesses, especially businesses that rely on innovation and design to be competitive.
- AC 2.3** Encourage access to affordable workspaces for artists, arts, and cultural organizations.
- AC 2.4** Improve technical- and financial-assistance programs to better target and serve both artists and arts organizations of various sizes and at various stages of growth, representing a broad range of cultures.
- AC 2.5** Enhance equitable access to technical and financial assistance for all artists and organizations.

Youth Development

Discussion

All students in all schools should be given the chance to learn through the arts. The arts are a core component of basic education, uniquely suited to develop twenty-first-century skills such as creative and critical thinking, communication, collaboration, and perseverance—skills directly linked to student success in school, career, and life.

Partnerships, both inside and outside of City government, are needed to bring back equitable access to arts education for all K–12 students. These collaborations will also help support after-school arts programs in diverse neighborhoods throughout the city. Through these in-school and after-school programs, experienced teaching artists, community groups, and cultural organizations can introduce children to all types of art, including visual arts, theater, dance, and film. Such programs give young people a chance to shine, to express themselves, and to develop positive goals for the future. Providing arts programs in schools with high numbers of low-income students is especially important, as many schools provide arts programs with additional funding from parents. This may not be possible in some schools.

GOAL

AC G3 Improve access to arts education in all schools and outside the school setting so that students are prepared to be successful in school and life.

POLICIES

- AC 3.1** Encourage schools to offer culturally relevant K–12 arts curricula that emphasize development and assessment of twenty-first-century skills.
- AC 3.2** Encourage schools to provide professional development in the arts for teachers and community arts partners.
- AC 3.3** Expand partnerships with educational institutions, arts institutions, youth service agencies, libraries, foundations, businesses, and arts and cultural organizations to increase participation in arts and culture programs, creative learning opportunities, and creative economy careers.
- AC 3.4** Help make arts education available in areas of high violence and poverty or where school performance is poor.
- AC 3.5** Prioritize arts and culture opportunities for youth and communities with limited or no access to the arts.

Cultural Space and Placemaking

Discussion

Every successful neighborhood includes cultural spaces, which not only house a range of cultural activity but also help define the very social character and identity of neighborhoods. These spaces include traditional spots such as theaters, galleries, art-house cinemas, and museums, as well as nontraditional areas such as music clubs, coffeehouses and bars that hang art, bookstores, and behind-the-scenes places such as artists' studios, rehearsal rooms, and offices. Creative placemaking uses arts and culture to increase the vibrancy of neighborhoods, cities, and regions. Instead of a single arts center or a cluster of large arts and cultural institutions, placemaking enriches public and private spaces, structures, and streetscapes to enhance quality of life and strengthen neighborhood identity. Creatively attracting people to places that need revitalization or are vacant or underutilized can also improve local business and public safety while bringing diverse people together.

GOAL

- AC G4** Support affordable cultural spaces in all neighborhoods, especially urban centers and villages where they are accessible to a broad range of people and where they can help activate the public realm.

POLICIES

- AC 4.1** Create and maintain an inventory of both public and private cultural spaces.
- AC 4.2** Create incentives to preserve or expand space for artists, arts organizations, and other cultural uses.
- AC 4.3** Consider making surplus City-owned property available to both artists and arts and cultural organizations.
- AC 4.4** Consider public-private partnerships as a way to provide affordable space to both artists and arts and cultural organizations.
- AC 4.5** Encourage using public and institutional spaces, such as parks, community centers, libraries, hospitals, schools, universities, and City-owned places, for arts and culture.
- AC 4.6** Encourage the designation of existing clusters of cultural spaces as cultural districts.
- AC 4.7** Encourage partnerships between the public, private, and nonprofit sectors to engage in creative placemaking projects.
- AC 4.8** Share a tool kit of ways communities can make their own art and culture, created in partnership with City departments and community interests.

- AC 4.9** Establish creative placemaking as part of local area planning.
- AC 4.10** Encourage the creation of cultural spaces for informal gathering and recreation, especially in more densely populated urban centers and villages and in communities of color that lack cultural spaces.
- AC 4.11** Enhance access to a variety of arts and cultural institutions and programs for at-risk youth, non-English-speaking residents, seniors, the visually and hearing impaired, and people with other disabilities.

Community Well-Being



Introduction

The goal of the planning, building, and investing described in other elements of this Plan is to make Seattle a better place for its residents. While the city's physical features, such as its walkability, good quality housing, and accessible parks and open spaces, can enhance Seattleites' health and happiness, the overall well-being of a community depends on much more. This element of the Plan goes beyond the physical features of the city and its neighborhoods to focus on the overall well-being of Seattleites. The City invests in people so that all families and individuals can meet their basic needs, share in our economic prosperity, and participate in building a safe, healthy, educated, just, and caring community.

This element emphasizes the importance of the human and social infrastructure of the city. Seattle's community is built and strengthened through social relationships formed around common values, arts and culture, ethnicity, education, family, and age groups.

While the City provides many services directly, it also supports the work of other public and private organizations. This element addresses how we build communities through programs, services, activities, and community involvement to make the city welcoming, safe, and engaging.







Supportive and Healthy Communities

Discussion

Healthy, sustainable, and safe communities are products of people working together. When residents respect one another, invest time and energy in their collaborations, and commit to them, their communities thrive. City government has an important role to play, but government and institutions cannot create or sustain community if individuals do not connect to the community. Children and youth are critical to the future of our city’s social well-being, while elders can help sustain our history and culture. Getting involved in community activities allows people to see the impact of their actions and can help them build supportive relationships with those around them. The City can support relationship-building by encouraging the participation of all members of the community.

One way to measure people’s participation in their community is whether they choose to vote in elections that affect decisions that could impact their lives. Nationally, people with low incomes turn out to vote at lower rates than people with high incomes. Voter turnout also varies by age, educational attainment, homeownership, and years living in the same home. The varying voter turnout rates seen in Seattle’s neighborhoods suggest similar dynamics here.

Voter Turnout by Precinct
November 2015 Election

-  6–24%
-  25–38%
-  39–46%
-  47–54%
-  55–70%
-  No registered voters

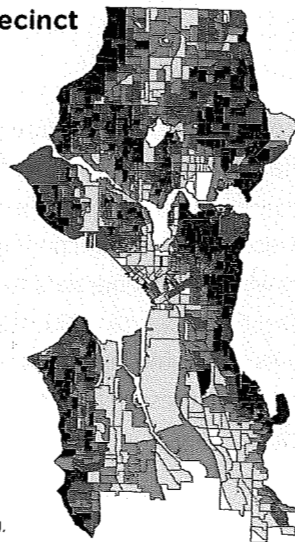

Source: King County Elections
Note: Voter turnout refers to the percentage of registered voters who cast their vote in an election.

GOAL

CW G1 Make Seattle a place where all residents feel they can be active in family, community, and neighborhood life, and where they help each other, contribute to the vitality of the city, and create a sense of belonging among all Seattleites.

POLICIES

- CW 1.1** Promote opportunities for people to build connections with their peers, neighbors, and the greater community by supporting intergenerational and intercultural programs, activities, and events.
- CW 1.2** Promote volunteerism and community service among people of all ages and cultures by providing information about opportunities to contribute their time, energy, or resources.
- CW 1.3** Enhance opportunities for children and youth to gain skills, increase self-esteem, and envision a positive future.
- CW 1.4** Reinforce efforts that strengthen the ability of children, youth, and families to participate in their health, wellness, and education, and to contribute to the development of a vibrant, growing community.
- CW 1.5** Celebrate young people's accomplishments, and promote activities for children and youth to increase their participation in the community.
- CW 1.6** Engage older residents in community conversations and volunteer opportunities so that they can find fulfillment in ways that benefit themselves and the community.

Access to Food and Shelter

Discussion

Seattle's quality of life and economic future depend on the overall health of its people. With a growing population, the City must be innovative and responsive in helping all Seattleites meet their basic needs. There are people in the city who lack food or shelter, who are vulnerable, or who face barriers to functioning independently. The City's goal is to make Seattle the kind of place where all people want to live and raise their families, and where those who are most vulnerable have access to the assistance they need. See the **Housing element** for how the City works to provide housing for low-income households. Ensuring that people in our communities have access to food and shelter before and after an emergency or disaster is especially critical.

Area service providers and shelters report heightened risk for homelessness for people of color, youth identifying as LGBTQ, military veterans, the disabled, people with mental illnesses, and people with substance abuse. For example:

- About 71 percent of the people in family shelters are people of color.
- 58 percent of people in Seattle's shelters for adults report having a disability, and 16 percent report having served in the military.
- More than 20 percent of the city's homeless and unstably housed youth and young adults identified as LGBTQ (lesbian, gay, bisexual, transgender, or queer).

Source: "Homeless Needs Assessment," City of Seattle 2014–2017 Consolidated Plan for Housing & Community Development.

GOAL

- CW G2** Reduce poverty and its effects, which make people, especially children and elderly adults, vulnerable.

POLICIES

- CW 2.1** Encourage coordinated service delivery for food, housing, health care, and other basic necessities for people and families in need.
- CW 2.2** Contribute to efforts that help people meet their basic needs, maintain their independence as long as possible, and remain in their neighborhoods of choice.
- CW 2.3** Support efforts to provide access to healthy, affordable food for all people in Seattle.
- CW 2.4** Encourage public and private efforts that support culturally appropriate food opportunities, including grocery stores, farmers' markets, food banks, and nutrition programs, especially to meet the nutritional needs of infants, children, elders, and other vulnerable populations in their neighborhoods.
- CW 2.5** Provide access to healthy food by encouraging better distribution and marketing of healthy options throughout the city and by addressing nutrition standards in programs supported by the City.
- CW 2.6** Encourage local food production, processing, and distribution through the support of home and community gardens, farmers' markets, community kitchens, and other collaborative initiatives to provide healthy foods and promote food security.
- CW 2.7** Consider using City land to expand the capacity to grow, process, distribute, and access local food, particularly for distribution to households in need.
- CW 2.8** Invest in services and programs that prevent homelessness, provide a pathway to permanent housing, and allow temporary shelter for those who are homeless.
- CW 2.9** Place special emphasis on programs addressing those who are most vulnerable to homelessness.

- CW 2.10** Develop an increased level of emergency preparedness among all segments of the population to help coordinate governmental response and recovery efforts that seek to minimize the adversity of a major emergency or disaster.

Healthy Growth, Aging, and Lifestyles

Discussion

A person's health greatly affects his or her quality of life and ability to participate fully in the community. Social and environmental factors, as well as access to health care, all contribute to an individual's overall personal health. City efforts can promote healthy choices, help people avoid risk, and provide assistance to those who encounter health problems.

GOAL

- CW G3** Create a healthy environment where community members of all ages, stages of life, and life circumstances are able to aspire to and achieve a healthy life, are well nourished, and have access to affordable health care.

POLICIES

- CW 3.1** Encourage Seattleites to adopt healthy and active lifestyles to improve their general physical and mental health and well-being and to promote healthy aging. Provide information about and promote access to affordable opportunities for people to participate in fitness and recreational activities and to enjoy the outdoors.
- CW 3.2** Work toward the reduction of health risks and behaviors leading to chronic and infectious diseases and infant mortality, with particular emphasis on populations disproportionately affected by these conditions.
- CW 3.3** Collaborate with Public Health—Seattle & King County, private hospitals, and community health clinics to maximize access to health care coverage for preventive care, behavioral health, and long-term care.
- CW 3.4** Seek to improve the quality and equity of access to health care, including physical and mental health, emergency medical care, addiction services, and long-term care by collaborating with community organizations and health providers to advocate for quality health care and broader accessibility to services.
- CW 3.5** Support access to preventive interventions at agencies that serve the homeless, mentally ill, and chemically dependent populations.
- CW 3.6** Support efforts to reduce exposure to secondhand tobacco smoke in indoor and outdoor areas, particularly where vulnerable populations, such as children and seniors, are likely to be present.

CW 3.7 Require healthy building methods and materials in City-funded projects, and encourage private development to use construction methods and materials that result in healthy indoor environments for all Seattleites.

Lifelong Learning

Discussion

Well-educated people have the skills to pursue opportunities and careers of their choice. Providing quality education for all Seattleites requires coordination with Seattle Public Schools, libraries, colleges, and universities, as well as with other public agencies, nonprofit agencies, community groups, and business organizations. Through cooperation with these groups and with the community, the City can help make quality education, learning, and training available to children, youth, and adults.

Each fall, kindergarten teachers in Washington do an assessment of their students' skills in six domains: social-emotional, physical, cognitive, language, literacy, and mathematics. Seattle Public Schools teachers find that students of color and students in low-income households are less kindergarten-ready than classroom peers. In 2015, 52 percent of students overall demonstrated skills typical of a kindergartner across all six domains, compared with significantly lower percentages of low-income students and students of black or African American, Pacific Islander, or Hispanic ethnicity.

Kindergarten Readiness in Seattle Public Schools

Share of Students Demonstrating Expected Skills in All of the Six Domains Assessed

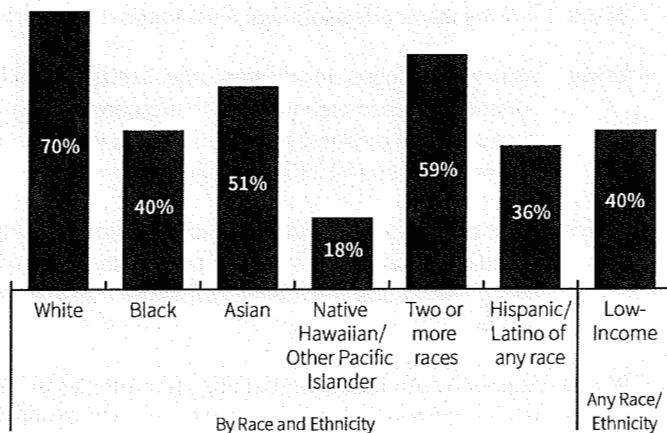

Source: Fall 2015 WaKIDS assessment, Washington State School Report Card, Office of the Superintendent of Public Instruction.

GOAL

CW G4 Support an education system and opportunities for lifelong learning that strengthen literacy and employability for all Seattleites.

POLICIES

- CW 4.1** Create equitable access to high-quality early-learning services, and support families so that their children are prepared for school.
- CW 4.2** Support schools' efforts to develop culturally competent disciplinary practices that keep children engaged with their schools, while still requiring behavioral accountability.
- CW 4.3** Encourage parent, volunteer, business, and community support for education and involvement in schools.
- CW 4.4** Support Seattle Public Schools' efforts to create safe learning environments in and after school that promote academic and personal achievement for all children and youth.
- CW 4.5** Support opportunities for community-based learning through service projects that have value to both the students and the community.
- CW 4.6** Work with schools, higher education institutions, libraries, community centers, and arts and cultural agencies and organizations to link services into a seamless system that helps students stay in school, such as through colocation of services and joint use of facilities.
- CW 4.7** Support programs that help people who have dropped out or are at risk of dropping out of high school to achieve education, personal, and employment goals.
- CW 4.8** Provide literacy development and related resources for English-language learners.
- CW 4.9** Work with colleges, universities, other institutions of higher learning, and community-based organizations to promote lifelong learning opportunities and encourage the broadest possible access to libraries, community centers, schools, and other existing facilities throughout the city.
- CW 4.10** Work with schools, libraries, and other educational institutions, community-based organizations, businesses, labor unions, and other governments to develop strong educational and training programs that provide pathways to successful employment.
- CW 4.11** Support youth-based job-training opportunities that provide classes, coaching, and the development of skills leading to jobs with livable wages.

Public Safety

Discussion

Public safety is a shared responsibility shouldered by individuals, families, and communities alike. It should include focus on early intervention, such as human service efforts that prevent unsafe situations from occurring and other efforts that intervene before situations

become serious. Building safer communities requires the commitment of all Seattleites, from youth to adults. City government can act as a connector in this effort. It can help build partnerships between the individuals, agencies, and other groups that work to address the safety needs of individuals and the community at large.

GOAL

CW G5 Reduce violence and the incidence of crimes, and increase the sense of security throughout the city.

POLICIES

- CW 5.1** Coordinate across City departments and with other agencies to address violence, abuse, and exploitation and to hold offenders accountable.
- CW 5.2** Plan and implement best and promising practices that focus on preventing violence.
- CW 5.3** Ensure that violence prevention, violence intervention, and offender accountability programs are culturally and linguistically appropriate.
- CW 5.4** Increase awareness of all forms of violence and abuse and the resources that exist to assist in dealing with these issues.
- CW 5.5** Emphasize education, prevention, and early intervention to reduce the risk of exposure to negative health impacts, violence, and injury.
- CW 5.6** Encourage efforts that enhance strong family relationships and healthy child development to help prevent child abuse, sexual assault, and domestic violence.
- CW 5.7** Work in partnership with state, county, and community agencies to prevent violence, including that associated with substance abuse, and firearms injuries.
- CW 5.8** Encourage a policing strategy that works in partnership with the community to reduce crime through education and enforcement.
- CW 5.9** Encourage communities to build block-by-block networks to prevent crime, develop social networks, and solve common problems.
- CW 5.10** Provide competent, professional, and efficient City criminal-justice services that hold those who commit crimes accountable, reduce recidivism, and achieve a fair and just outcome.
- CW 5.11** Work in partnership with the state, King County, and community organizations to connect local detention facilities with the health and human service systems.
- CW 5.12** Reinforce the linkage between public safety and human services to encourage lawful behavior, reduce vulnerabilities of street populations, and address family violence and sexual assault.
- CW 5.13** Strive to prevent youth crime, youth violence, and gang activity by promoting efforts that strengthen the community and create capacity for youth to be involved in

programs and activities that are alternatives to crime and violence, and that provide a positive path for their lives.

- CW 5.14** Work with Seattle Public Schools to make schools safe places where all youth can experience success in education and preparation for future productive lives.
- CW 5.15** Strengthen the relationship between Seattle Public Schools and the Seattle Public Library to provide safe places outside of school for children and youth to learn, explore, and connect with other educational, workforce, and personal development opportunities.
- CW 5.16** Promote information sharing and resource coordination among the courts, jails, prosecutors, and police for greater efficiency and more equitable outcomes in the criminal-justice system.
- CW 5.17** Report crime statistics periodically to guide future decisions about programs and resource allocation that can help control crime and make Seattleites feel safer in the city.

A Multicultural City

Discussion

Seattle benefits from diversity. We celebrate the richness of our diverse heritage, talents, and perspectives, all of which build a stronger Seattle. Seattle envisions a city where racial inequities have been eliminated and racial equity achieved. The City's Race and Social Justice Initiative aims to end institutional racism in City government, eliminate race-based disparities, and promote multiculturalism and full community involvement by all residents.

The number of people of color living in Seattle continued to increase between 2000 and 2010, but much more slowly than it did in the remainder of King County. This was true particularly for people under age eighteen. The number of children of color increased by only 2 percent in Seattle, compared with 64 percent in the balance of King County.

Population Growth from 2000 to 2010

Seattle and Remainder of King County

	Increase in Total Pop.	Increase in Pop. of Color	Growth Rate of Total Pop.	Growth Rate of Pop. of Color
Seattle	45,286	24,240	8%	13%
Remainder of King County	148,929	193,802	13%	69%

	Increase in Total Pop. Under Age 18	Increase in Pop. of Color Under Age 18	Growth Rate of Total Pop. Under Age 18	Growth Rate of Pop. of Color Under Age 18
Seattle	5,686	896	6%	2%
Remainder of King County	17,170	59,062	6%	64%

GOAL

CW G6 Provide equitable opportunity and access to services for all Seattleites.

POLICIES

- CW 6.1** Enhance opportunities for people with low-incomes, disabilities, limited English, cultural barriers, time constraints, transportation limitations, and other barriers to gain access to services they need.
- CW 6.2** Promote culturally responsive and relevant service delivery from City departments and other agencies, including translation and interpretation services.
- CW 6.3** Provide opportunities for, and actively recruit, diverse representation on City boards, commissions, and advisory committees that contribute to City decision-making.
- CW 6.4** Promote respect and appreciation for diversity of ability, age, culture, economic status, gender identity, national origin, race, religion, and sexual orientation, including economic, racial, cultural, and individual differences, and support efforts to achieve diversity throughout the city.
- CW 6.5** Promote racial and social justice, human and civil rights, and mutual respect to reduce intolerance.
- CW 6.6** Celebrate the richness of diversity through cultural activities and events that bring people together to experience ethnic and cultural traditions.

Coordination of Services

Discussion

The City plays an important role in building human service and public safety systems. These systems must be culturally responsive, efficient, and accessible to all people. The City contracts with multiple community-based organizations to help develop and deliver high-quality services to residents across communities. Locating multiple services in neighborhood centers can make it easier for people to find and use the services they need.

GOAL

CW G7 Develop a flexible, comprehensive, coordinated, and efficient system of human services that addresses the needs of people, families, and communities.

POLICIES

- CW 7.1** Encourage cooperative planning, decision-making, and funding for health and human service delivery throughout the region.
- CW 7.2** Join with other public and private institutions in the region to develop a stable and adequate funding base for services that support safe and healthy communities.
- CW 7.3** Strive to disseminate more coordinated information about the availability of services in the community.
- CW 7.4** Develop customer-focused services, using feedback from participants, and involve consumers in identifying needs and planning for service delivery.
- CW 7.5** Consider related issues, such as transportation and the need for dependent care, when planning for health, human services, employment, education, and recreation programs.
- CW 7.6** Encourage neighborhood organizations to address a broad range of human service issues to match neighborhood or community strengths and needs, and to identify solutions that make service delivery more relevant, responsive, accessible, and user-friendly.
- CW 7.7** Site new human service facilities in or near urban centers and villages, and use good-neighbor guidelines that consider the needs of consumers and the community.
- CW 7.8** Encourage use of existing facilities and colocation of services, including joint use of schools and City and community facilities, to make services available in underserved areas and in urban village areas.
- CW 7.9** Collaborate with community organizations and other jurisdictions to advocate for strong health, human service, and public safety systems, including services for mental health and substance abuse.
- CW 7.10** Identify and implement effective ways to measure program performance and results, balancing accountability and efficiency with the need to encourage service innovation.

Neighborhood Planning



Introduction

Creating and implementing individual neighborhood plans can help residents apply this Comprehensive Plan at a local level. These neighborhood plans can reflect the history, character, and vision of the local community. They can also provide more neighborhood-specific guidance than the citywide policies do for areas where growth and change are occurring or desired. In some cases, neighborhood plans address topics not covered elsewhere in the Plan; in other cases, they give local examples for how a citywide policy would be best implemented in that neighborhood.

Seattle has a long history of planning within its neighborhoods. After the original adoption of this Comprehensive Plan in 1994, the City offered funds to certain neighborhoods to allow them to prepare individual plans. These neighborhoods included those that either contained an urban center or urban village or were identified as economically distressed. Thirty-seven neighborhoods took advantage of that offer, and those neighborhoods all

produced plans between 1995 and 2000. Those new plans replaced plans prepared in the 1970s and 1980s, and they form the basis for most of the plans contained in this element. The City Council adopted goals and policies resulting from those efforts into the Comprehensive Plan, and the adopted neighborhood plans can be found in **Neighborhood Plans**. Nearly half of these plans have been updated since their initial adoption or are currently being updated. The plans in this element are the most recent versions of the adopted neighborhood plans.

The process for neighborhood planning has varied over time and according to each neighborhood's circumstances and concerns. In the late 1990s the planning processes were led by neighborhood groups. They received logistical support from City staff and technical support from consultants hired with funds provided by the City. In addition to providing goals and policies for each neighborhood, these plans identified actions each neighborhood could take and programs each could develop.

A few years ago, the Seattle Planning Commission reviewed all the neighborhood plans and found that "the plans still provide relevant guidance for future planning and implementation efforts." And updates to many of these plans have brought more focus to detailed planning and implementation work. As City departments develop functional plans or carry out programs in neighborhoods throughout Seattle, they can draw guidance from the neighborhood plans.

In recent years City staff have worked with a number of neighborhoods to update their plans, including several of the neighborhoods now served by light rail. In these cases, neighborhoods reconsider the original vision of their plans. They identify specific actions to help implement the revised visions and sometimes suggest changes to zoning to affect the physical layout and development potential of the neighborhood. These processes engage broad cross sections of a neighborhood's residents and businesses. They are joined in this work by relevant City departments and other public agencies to create an integrated and equitable plan for the community.

One of Seattle's great assets is the richness of its community—Seattle includes renters and property owners, foreign-born and native-born residents, youth and seniors, and diverse communities of color. The City's neighborhood-planning process embraces this richness. Through both the planning process and the implementation of the plans, the City fosters meaningful engagement with communities. Residents, businesses, City departments, and partner agencies work together to help achieve the shared vision.

As the City works with neighborhoods on individual neighborhood plans in the future, they may refine the visions in the existing plans, update the goals and policies, and identify the necessary steps to achieve them. Collaboration between the neighborhoods and City staff will remain key to this process. Naturally, many neighborhood plans contain policies that seem redundant with policies in other elements of this Plan. Future neighborhood-planning

processes should consider ways to limit such redundancy and provide more focus on the unique circumstances and aims for the individual neighborhoods.

GOAL

NP G1 Help fulfill the Comprehensive Plan's values, vision, and goals by maintaining plans for neighborhoods where growth is expected to occur and by including strategies that address the specific growth and equity issues that are appropriate to each neighborhood.

POLICIES

NP 1.1 Prioritize neighborhood planning in areas expecting or experiencing significant change, primarily urban centers and urban villages, especially those that have not equitably benefited from the city's growth.

NP 1.2 Engage a wide range of people from the neighborhood in each neighborhood-planning process, including homeowners, renters, business owners, and employees, with special emphasis on groups that have historically been underrepresented.

NP 1.3 Develop neighborhood plans to be consistent with this Plan's vision, and use neighborhood plans to focus on improvements that will help each neighborhood fulfill this Plan's vision for a growing and equitable city.

NP 1.4 Use an integrated planning approach that involves relevant City departments to create strong, effective strategies for developing and implementing neighborhood plans.

NP 1.5 Consider neighborhood-plan recommendations when prioritizing City capital investments and service allocations.

NP 1.6 Support neighborhood-plan implementation to encourage healthy urban environments and to promote continued collaboration between the City and neighborhood groups.

Container Port



Introduction

One of the factors behind Seattle's strong economy is the city's role in importing and exporting goods. The Port of Seattle operates one of the largest container-shipping facilities on the West Coast. Not only do the workers who move cargo in and out of the shipping terminals make good wages, but exporting goods made in the Seattle area brings additional money into the regional economy. The Land Use, Transportation, and Economic Development elements of this Plan contain related policies about the importance of these areas and how the City regulates uses and provides critical transportation services to them.

GOAL

- CP G1** Maintain viable and thriving import and export activities in the city as a vital component of the city's and the region's economic base.

POLICIES

- CP 1.1** Help preserve cargo-container activities by retaining industrial designations on land that supports marine- and rail-related industries, including industrial land adjacent to rail- or water-dependent transportation facilities.
- CP 1.2** Continue to monitor the land area needs, including those related to expansion of cargo container–related activities, and take action to prevent the loss of land needed to serve these activities.
- CP 1.3** Discourage nonindustrial land uses, such as retail and residential, in industrially zoned areas to minimize conflicts between uses and to prevent conversion of industrial land in the vicinity of cargo-container terminals or their support facilities.
- CP 1.4** Consider how zoning designations may affect the definition of highest and best use, with the goals of maintaining the jobs and revenue that cargo-container activities generate and protecting scarce industrial land supply for cargo-container industries, such as marine- and rail-related industries.
- CP 1.5** Consider the value of transition areas—which allow a wider range of uses while not creating conflicts with preferred cargo-container activities and uses—at the edges of general industrial zones. In this context, zoning provisions such as locational criteria and development standards are among the tools for defining such edge areas.
- CP 1.6** Monitor, maintain, and improve key freight corridors, networks, and intermodal connections that provide access to cargo-container facilities and the industrial areas around them to address bottlenecks and other access constraints.
- CP 1.7** Provide safe, reliable, efficient, and direct access between Port marine facilities and the state highway or interstate system, and between Port terminals and railroad intermodal facilities, recognizing that Port operations must address other transportation needs, such as pedestrian safety.
- CP 1.8** Make operational, design, access, and capital investments to accommodate trucks and railroad operations and preserve mobility of goods and services. Improvements may include improvement of pavement conditions, commute trip reduction strategies, roadway rechannelization to minimize modal conflicts, use of intelligent transportation systems, construction of critical facility links, and grade separation of modes, especially at heavily used railroad crossings.
- CP 1.9** Maintain a City classification for freight routes to indicate routes where freight will be the major priority. Street improvements that are consistent with freight mobility but also support other modes may be considered in these streets.
- CP 1.10** Identify emerging cargo-container freight transportation issues by working with affected stakeholder groups, including the Seattle Freight Advisory Board. Provide regular opportunities for communication between the City, the freight community, other affected communities, and other agencies and stakeholders.
- CP 1.11** Continue joint City and Port efforts to implement relevant Port recommendations, such as recommendations contained in the Container Terminal Access Study.

- CP 1.12** Given the importance of cargo container-terminal operations to the state and regional economies, develop partnerships within the City, the Port, the region, and the State to advocate for project prioritization and timely funding to improve and maintain freight infrastructure, and explore funding partnerships.
- CP 1.13** Maintain consistency between local, regional, and State freight-related policies.
- CP 1.14** Encourage the siting of new businesses that support the goals for cargo-container activities in the City's manufacturing/industrial centers.
- CP 1.15** Work cooperatively with other agencies to address the effects of major land use and transportation projects to avoid or mitigate construction and operational effects on the cargo container-industry sector.
- CP 1.16** Facilitate the creation of coalitions of industrial businesses, vocational training and other educational institutions, and public agencies to help develop training programs to move trained workers into cargo container-related jobs.
- CP 1.17** Identify opportunities to achieve economic, community, and environmental benefits from the development and operations of cargo container-related activities, including access to employment for historically excluded populations.
- CP 1.18** Form partnerships with nonprofit, community-based, private, and public stakeholders to establish environmental improvement goals, including carbon dioxide emission reductions, stormwater management, redevelopment and cleanup of existing marine industrial properties, sustainable design, and fish- and wildlife-habitat improvements. Develop strategies to achieve these goals that include developing funding mechanisms and legislative support.
- CP 1.19** Work with nonprofit, community-based, private, and public stakeholders to formulate plans for public open space, shoreline access, and fish- and wildlife-habitat improvements that incorporate community needs and area-wide habitat priorities with the need to maintain sufficient existing marine industrial lands for present and anticipated cargo-container needs.

Shoreline Areas



Introduction

Land near the City's major water bodies—Puget Sound, Lake Washington, Lake Union, the Lake Washington Ship Canal, and the Duwamish River—has special importance to the city, its residents, and its businesses. These areas are covered by the State Shoreline Management Act. The City has adopted the Seattle Shoreline Master Program to describe the rules that govern the functions allowed in shoreline areas. Some businesses—like cargo terminals and boat repair—need to be right on the water. Shoreline areas also provide space for recreation, public access and viewing, and natural areas. This element of the Plan guides how the City will set rules for the development that goes in the city's shoreline areas. Together with the Shoreline Master Program regulations in the City's Land Use Code, maps of the locations of shoreline environments, and the Shoreline Restoration and Enhancement Plan, these policies constitute the Seattle Shoreline Master Program. Because these policies were originally adopted through a separate process, they use a slightly different numbering system than the rest of the Plan.

Shoreline Use

GOALS

- SA G1** Encourage shoreline uses that result in long-term over short-term benefit.
- SA G2** Define appropriate uses for specific segments of the shoreline.
- SA G3** Locate uses that are not water dependent or water related on upland lots to optimize shoreline use and access.
- SA G4** Protect ecological function of those areas of shoreline that are biologically significant or that are geologically fragile.
- SA G5** Restore and enhance ecological function through nonregulatory programs and policies.

POLICIES

- SA P1** Allow only those uses, developments, and shoreline modifications that retain options for future generations, unless identified benefits clearly outweigh the physical, social, environmental, and economic loss over a twenty-year planning horizon. Use preference will be given in the following order:
 - 1. On waterfront lots:
 - a. Uses that protect or restore and enhance natural areas and ecological processes and functions, particularly those areas or systems identified as containing or having unique geological, ecological, or biological significance.
 - b. Water-dependent uses—uses that cannot exist outside a waterfront location and are dependent on the water by reason of the intrinsic nature of operations.
 - c. Water-related uses—uses or portions of uses not intrinsically dependent on a waterfront location but whose economic viability is dependent upon a location in the shoreline district because
 - i. the use has a functional requirement for a waterfront location, such as the arrival or shipment of materials by water (a substantial portion of up to 50 percent of its product or materials arrive by vessel), or the need for large quantities of water in the use;
 - ii. material is stored that is transported by a vessel and is either loaded or off-loaded in the shoreline district; or
 - iii. the use provides a necessary service supportive of water-dependent uses, and the proximity of the use to its customers makes its services less expensive and/or more convenient.

- d. Water-enjoyment uses—those uses that facilitate public access to the shoreline as a primary characteristic of the use; or uses that provide for recreational use or aesthetic enjoyment of the shoreline for a substantial number of people as a general characteristic of the uses and which, through location, design, and operation, ensure the public’s ability to enjoy the physical and aesthetic qualities of the shoreline. In order to qualify as a water-enjoyment use, the use must be open to the general public, and the shoreline-oriented space within the project must be devoted to the specific aspects of the use that foster shoreline enjoyment.
 - e. Floating home uses existing as of January 2011, which are considered conforming preferred uses because of their historic role and legal recognition by the City. The intent of this policy is to recognize the existing floating home community in Lake Union and Portage Bay, while protecting natural areas, preserving public access to the shoreline, and preventing the displacement of water-dependent commercial and manufacturing uses by new floating homes. Applicable development and Shoreline Master Program regulations may impose only reasonable conditions and mitigation that will not effectively preclude maintenance, repair, replacement, and remodeling of existing floating homes and floating home moorages by rendering these actions impracticable.
 - f. Single-family residential uses—these are preferred uses when they are appropriately located and can be developed without significant impact to ecological functions or displacement of water-dependent uses.
 - g. Uses that are not water dependent with regulated public access or with ecological restoration and enhancement.
 - h. Uses that are not water-dependent, water-related, or water-enjoyment uses as defined above, without regulated public access or ecological restoration and enhancement.
2. On upland lots: preferred uses are those that complement uses on adjacent waterfront lots.
 3. The preference for protection of the ecological conditions of the shoreline shall be accomplished by prohibiting uses that would negatively impact natural areas, by providing mitigation for negative impacts caused by the use and by providing restoration and enhancement of natural areas where they are degraded.
 4. Preferred uses will vary according to the purpose of the shoreline environment.
 - a. Where the purpose of the environment is to encourage water-dependent and water-related uses, these uses shall be preferred by prohibiting and/or restricting the number of uses that are not water dependent or water related allowed on waterfront lots.

- b. Where the purpose of the environment is to provide public access, these uses shall be preferred by allowing uses that provide public access.
- c. Where the purpose of the environment is to protect ecological processes and functions, uses that achieve this purpose shall be preferred.

- SA P2** In the Land Use Code, identify appropriate shoreline uses and related standards, and provide site-development standards and other appropriate criteria indicating minimal acceptable standards to be achieved.
- SA P3** Allow people to live aboard vessels in moorage areas, and provide standards that mitigate the impacts of live-aboard uses on the shoreline environment.
- SA P4** Allow a wider range of uses on upland lots than on waterfront lots in order to support water-dependent and water-related uses on waterfront lots, while avoiding potential incompatibility with those uses.

Shoreline Access

GOALS

- SA G6** Maximize public access—both physical and visual—to Seattle’s shorelines.
- SA G7** Preserve and enhance views of the shoreline and water from upland areas, where appropriate.

POLICIES

- SA P5** Enable opportunities for substantial numbers of people to enjoy the shorelines by requiring access to public property located on the water and by allowing uses that are not water dependent to locate on waterfront lots when those uses provide additional public access to the shoreline and are located in waterfront areas less suited for water-dependent uses.
- SA P6** Promote public enjoyment of the shorelines through public-access standards that require improvements to be safe, be well-designed, and have adequate access to the water.
- SA P7** Encourage adopt-a-beach and other programs that promote voluntary maintenance of public-access areas in the shoreline district.
- SA P8** Maintain standards and criteria for providing public access, except for lots developed for single-family residences, to achieve the following:
 - 1. Linkages between shoreline public facilities via trails, paths, etc. that connect boating and other recreational facilities
 - 2. Visible signage at all publicly owned or controlled shorelines and all required public access on private property

3. Development of bonuses or incentives for the establishment of public access on private property, if appropriate
4. Provision of public-access opportunities by public agencies such as the City, Port of Seattle, King County, and the State at new shoreline facilities (encourage these agencies to provide similar opportunities in existing facilities)
5. View and visual access from upland and waterfront lots
6. Prioritization of the operating requirements of water-dependent uses over preservation of views
7. Protection and enhancement of views by limiting view blockage caused by off-premises signs and other signs

SA P9 Waterways, which are public highways for watercraft providing access from land to water and from water to land platted by the Washington State Harbor Line Commission for the convenience of commerce and navigation, in Lake Union and Portage Bay, are for public navigation access and commerce, and in general, the City shall not request that the designation be removed from waterways. The City may request that waterways be vacated only when the City reclaims the area as street right-of-way or for public park purposes. The City may request that the dry land portion of a waterway be redesignated for the additional purpose of providing permanent public-access improvements.

SA P10 Shoreline street ends are a valuable resource for public use, access, and shoreline restoration. Design public or private use or development of street ends to enhance, rather than reduce, public access and to restore the ecological conditions of the shoreline.

Transportation in the Shoreline

GOALS

- SA G8** Provide a transportation network that supports and enhances use of and access to the shorelines.
- SA G9** Relocate or demolish transportation facilities that are functionally or aesthetically disruptive to the shoreline, such as the aerial portion of the Alaskan Way Viaduct on the Central Waterfront between King Street and Union Street.

POLICIES

- SA P11** Encourage the transport of materials and cargo in the shoreline district via modes having the least environmental impact.

SA P12 Encourage large vessels (cruise ships and cargo-container ships) to connect to dockside electrical facilities or use other energy alternatives while in port in order to reduce engine idling and exhaust emissions.

SA P13 Discourage, and reduce over time, vehicle parking on waterfront lots in the shoreline district.

SA P14 Encourage the maintenance and future development of intermodal commuter ferry services to complement other public transportation systems, from both intracity locations and elsewhere in the region.

SA P15 Provide public transportation convenient to the shoreline.

SA P16

1. Locate streets, highways, freeways, and railroads away from the shoreline in order to maximize the area of waterfront lots. Discourage streets, highways, freeways, and railroads not needed for access to shoreline lots in the shoreline district. A replacement for the State Route 99 Viaduct with a tunnel and/or a surface roadway may be located in the shoreline district because it represents a critical link in the transportation network.
2. To facilitate expeditious construction in an environmentally and fiscally responsible manner, standards for major state and regional transportation projects should be considered that will allow flexibility in construction staging, utility relocation, and construction-related mitigation and uses, provided that the projects result in no net loss of ecological function.
3. Prohibit aerial transportation structures over thirty-five feet high, such as bridges and viaducts, on the Central Waterfront in the shoreline environments between King Street and Union Street, except for aerial pedestrian walkways associated with Colman Dock, in order to facilitate the revitalization of Downtown's waterfront, provide opportunities for public access to the Central Waterfront shoreline, and preserve views of Elliott Bay and the land forms beyond.

SA P17 The primary purpose of waterways in Lake Union and Portage Bay is to facilitate navigation and commerce by providing waterborne access to adjacent properties, access to the land for the loading and unloading of watercraft, and temporary moorage. Waterways are also important for providing public access from dry land to the water.

SA P18 Public access shall be the preferred use for vacated rights-of-way. Public rights-of-way may be used or developed for uses other than public access, provided that such uses are determined by the City to be in the public interest, and that public access of substantial quality and at least comparable to that available in the right-of-way is provided.

Shoreline Protection and Restoration

GOALS

- SA G10** Require that no net loss of ecological functions occurs as a result of uses, development, shoreline modifications, maintenance activities, or expansion of existing uses.
- SA G11** Identify those areas of shorelines that are geologically or biologically unstable, fragile, or significant, and regulate development to prevent damage to property, the general public, aquatic and terrestrial species, and shoreline ecological functions.
- SA G12** Preserve, protect, and restore areas necessary for the support of terrestrial and aquatic life or those identified as having geological or biological significance.
- SA G13** Use scientific information to guide shoreline protection, enhancement, and restoration activities.
- SA G14** Address and minimize the impacts of sea-level rise on the shoreline environment with strategies that also protect shoreline ecological functions, allow water-dependent uses, and provide public access.
- SA G15** Encourage the establishment of marine protected areas, where appropriate.
- SA G16** Restore lower Duwamish watershed habitat and marine ecology while sustaining a healthy and diverse working waterfront in this urban industrial environment.
- SA G17** Strengthen the vitality of a functioning ecosystem within Water Resource Inventory Areas (WRIA) 8 and 9 by integrating development projects into their surrounding environments, by supporting a diversity of habitats, and by strengthening connections between habitats throughout each watershed.

POLICIES

- SA P19** Use mitigation sequencing to meet no net loss of ecological functions. Mitigation sequencing refers to taking steps in this order: avoid, rectify, minimize, and/or compensate for the loss to ecological functions.
- SA P20** Protect the natural environment of the shoreline through development regulations that include a requirement to use best management practices to control impacts from construction and development activities.
- SA P21** Regulate development on those areas of shorelines that are biologically significant or geologically fragile to prevent harm to property, organisms, or the general public.
- SA P22** Develop methods to measure both the impacts of development in the shoreline district and the effects of mitigation so that no net loss of ecological function occurs through development projects.

- SA P23** Monitor the benefits of mitigation techniques to determine which are best suited to meet the goal of no net loss of ecological function.
- SA P24** Conserve existing shoreline vegetation and encourage new shoreline plantings with native plants to protect habitat and other ecological functions, reduce the need for shoreline stabilization structures, and improve visual and aesthetic qualities of the shoreline.
- SA P25** Avoid development in areas identified as special wildlife or priority saltwater or freshwater habitat unless no feasible alternative locations exist except for a water-dependent use or water-related use that has a functional requirement for a location over water and is located in saltwater habitat that is priority habitat solely due to its use by anadromous fish for migration, if the development mitigates impacts to achieve no net loss of ecological function.
- SA P26** Protect environmentally critical areas as set out in the policies for environmentally critical areas and modified to reflect the special circumstances of such areas in the shoreline district.
- SA P27** Require that all commercial, industrial, or other high-intensity uses provide means for treating natural or artificial urban runoff to acceptable standards. Developments with industrial or commercial uses that use or process substances potentially harmful to public health and/or aquatic life shall provide means to prevent point and nonpoint discharge of those substances.
- SA P28** Consider the Lower Duwamish Watershed Habitat Restoration Plan (Weiner, K. S., and Clark, J. A., 1996); the Port of Seattle Lower Duwamish River Habitat Restoration Plan, the Final Lower Duwamish River NRDA Restoration Plan and Programmatic Environmental Impact Statement, the WRIA 8 Chinook Salmon Conservation Plan and implementation documents, and the WRIA 9 Salmon Habitat Plan and implementation documents when conducting planning, permitting, mitigation, and restoration activities within the Duwamish/Green River and Cedar River watersheds.
- SA P29** Allow dredging in the minimum amount necessary for water-dependent uses, environmental mitigation or enhancement, cleanup of contaminated materials, and installation of utilities and bridges.
- SA P30** Allow fill on submerged land that does not create dry land only where necessary and in a manner that minimizes short- and long-term environmental damage, for the operation of a water-dependent or water-related use, transportation projects of statewide significance, installation of a bridge or utility line, disposal of dredged material in accordance with the Dredged Material Management Program, beach nourishment, or environmental mitigation or restoration and enhancement. Design projects to ensure no net loss of ecological function through mitigation sequencing.
- SA P31** Permit landfill that creates dry land only where necessary for transportation projects of statewide significance, repair of pocket erosion for water-dependent and water-related uses, beach nourishment, or environmental mitigation or restoration and enhancement. Construct fill projects in a manner that minimizes short- and long-term environmental damage, and design projects to ensure no net loss of ecological function through mitigation sequencing.

- SA P32** Work with other government agencies and shoreline users to reduce the input of pollutants, to restore contaminated areas, to control disposal of dredge spoils, and to determine the appropriate mitigation for project impacts.
- SA P33** Use a restoration plan to identify areas that have potential for shoreline habitat restoration. Identify restoration opportunities that will best achieve ecological improvement, describe the appropriate restoration activities for the conditions in those areas, and provide incentives for achieving restoration of the shorelines.
- SA P34** Support programs that inform the public about shoreline conservation practices, and identify methods by which public and private shoreline owners or community groups may encourage aquatic and terrestrial life, require such methods when appropriate, and provide incentives for such projects.
- SA P35** Support the scientific study of the shoreline ecosystems that will provide information to help update baseline condition information; to monitor the impact of any action; and to guide protection, restoration, and enhancement activities to meet the no net loss requirements and implement the restoration plan.
- SA P36** Where applicable, new or expanded development and maintenance shall include environmental cleanup and restoration of the shoreline to comply with any relevant state and federal law.

Shoreline Economic Development

GOAL

- SA G18** Encourage economic activity and development by supporting the retention and expansion of existing water-dependent and water-related businesses on waterfront lots.

POLICIES

- SA P37** Support the retention and expansion of existing conforming water-dependent and water-related businesses, and anticipate the creation of new water-dependent and water-related development in areas now dedicated to such use.
- SA P38** Identify and designate appropriate land adjacent to deep water for industrial and commercial uses that require such condition.
- SA P39** Provide regulatory and nonregulatory incentives for property owners to include public amenities and ecological enhancements on private property.
- SA P40** Identify and designate appropriate land for water-dependent business and industrial uses as follows:
1. Cargo-handling facilities:
 - a. Reserve space in deep-water areas with adequate vessel-maneuvering areas to permit the Port of Seattle and other marine industries to remain competitive with other ports.

- b. Work with the Port of Seattle to develop a long-range port plan in order to provide predictability for property owners and private industry along the Duwamish River and Elliott Bay.
2. Tug and barge facilities: Retain Seattle's role as the gateway to Alaska, and ensure ample area is designated for uses that serve Puget Sound and Pacific trade.
3. Shipbuilding, boatbuilding, and repairs: Maintain a critical mass of facilities in Seattle in order to meet the needs of the diverse fleets that visit or have a home port in Seattle, including fishing, transport, recreation, and military vessels.
4. Moorage: Meet the long-term and transient needs of ships and boats including fishing, transport, recreation, and military vessels. Support long-term moorage in sheltered areas close to services, and short-term moorage in more open areas. Support the efficient use of Fishermen's Terminal, Shilshole Bay Marina, and other public moorage facilities. Protect commercial and recreational moorage from displacement by encouraging the full use of submerged lands for recreational moorage in areas less suited for commercial moorage and less sensitive to environmental degradation. Require large recreational marinas to provide some commercial transient moorage as part of their facilities.
5. Recreational boating: Maintain diverse opportunities for recreational boaters to access the water. Allow a variety of boating facilities, from launching ramps for small "car top" or "hand-carried" boats to major marinas. Encourage recreational moorage by providing both long-term and short-term moorage at marinas and short-term moorage at cultural and recreational sites.
6. Passenger terminals: Maintain and expand the opportunity for convenient travel by ship to local and distant ports for residents and visitors. Encourage passenger-only ferries on the Central Waterfront.
7. Fishing industry: Maintain a critical mass of support services, including boatbuilding and boat repair, moorage, fish processors, and supply houses to allow Seattle fishermen to continue to service and have a home port for their vessels in Seattle waters. Recognize the importance of the local fishing industry in supplying local markets and restaurants. Recognize the economic contribution of distant-water fisheries to Seattle's maritime and general economy.

SA P41 Allow multiuse developments including uses that are not water dependent or water related where the demand for water-dependent and water-related uses is less than the land available or if the use that is not water dependent is limited in size, provides a benefit to existing water-dependent and water-related uses in the area, or is necessary for the viability of the water-dependent uses. Such multiuse development shall provide shoreline ecological restoration, which is preferred, and/or additional public access to the shoreline to achieve other Shoreline Master Program goals.

Shoreline Recreation

GOALS

- SA G19** Manage and optimize publicly owned shorelines that are suitable for public recreation.
- SA G20** Increase shorelines dedicated to public recreation and open space.
- SA G21** Identify, protect, and reserve for public use and enjoyment areas in the shoreline district that provide a variety of public-access activities and that connect to other public-access sites so that public access is available throughout the city.
- SA G22** Allow increased opportunities for the public to enjoy water-dependent recreation, including boating, fishing, swimming, diving, and enjoyment of views.

POLICIES

- SA P42** Designate for water-dependent recreation, areas where there are natural beaches, large amounts of submerged land or sheltered water, and minimal heavy ship traffic or land suitable for heavy industrial activity, while protecting ecological functions.
- SA P43** Provide for recreational boating facilities, including moorage and service facilities, on publicly owned land, and encourage the provision of such facilities on private property in appropriate areas that minimize environmental impacts.
- SA P44** Increase publicly owned shorelines, giving priority to those areas of the City that lack recreational facilities.
- SA P45** Explore alternatives to acquisition for providing public recreation at the shoreline and on the water.
- SA P46** Identify submerged lands that could be used for underwater parks.

Shoreline Archaeological and Historic Resources

GOALS

- SA G23** Encourage the restoration, preservation, and maintenance of areas of the shoreline having significant archaeological and historical importance.
- SA G24** Encourage the restoration of archaeological and historic features of the shoreline where consistent with economic and environmental goals.

POLICIES

- SA P47** Designate, protect, preserve, and support restoration of sites and areas of the shoreline district having historic or cultural significance, including through landmark designation where appropriate.
- SA P48** Avoid impacts to areas identified as archaeologically and historically significant, unless no reasonable alternative locations exist and impacts to the resource are mitigated.

Shoreline Environments

Discussion

State law requires that the Shoreline Master Program address a wide range of physical conditions and development settings along the shoreline. The Shoreline Master Program spells out different measures for the environmental protection, allowed uses, and development standards for each area of the shoreline. Each distinct section of the shoreline is classified as a particular environment. The environment designations provide the framework for implementing shoreline policies and regulatory measures. The shoreline environments within Seattle's shoreline district are divided into two broad categories—conservancy and urban—and then subdivided further within these two categories.

The conservancy shoreline environments are less developed and provide for areas of navigation, recreation, and habitat protection. The urban shoreline environments are areas that are more developed and provide for single-family houses and water-dependent and water-related uses. The conservancy and urban shoreline environments are described in the following goals and policies.

Conservancy Shoreline Environments

GOAL

- SA G25** The conservancy shoreline environments are intended to provide for navigation; public access; recreation; and protection, restoration, and enhancement of ecological functions in the shoreline district, while allowing some development if designed to protect ecological functions.

Conservancy Management (CM) Environment

GOAL

- SA G26** The purpose of the Conservancy Management Environment is to preserve and enhance the shoreline environment while providing opportunities for shoreline recreation.

POLICIES

- SA P49** Encourage restoration of ecological functions in areas where such function has been degraded.
- SA P50** Accommodate water-oriented public infrastructure projects or such projects that require a waterfront location and that are compatible with the ecological functions of the area.

Conservancy Navigation (CN) Environment

GOAL

- SA G27** The purpose of the Conservancy Navigation Environment is to preserve the shoreline environment while providing navigational use of the water.

POLICIES

- SA P51** Allow in-water and overwater structures that are primarily for navigational purposes.
- SA P52** Enhance and restore ecological function, where feasible, in areas where such function has been previously degraded.

Conservancy Preservation (CP) Environment

GOAL

- SA G28** The purpose of the Conservancy Preservation Environment is to preserve, enhance, and restore the ecological functions in the shoreline district.

POLICIES

- SA P53** Prohibit uses that substantially degrade the ecological functions or natural character of the shoreline.
- SA P54** Prohibit commercial and industrial uses and non-water-oriented recreation.
- SA P55** Prohibit parking that can be located outside the CP area.
- SA P56** Limit access and utilities to those necessary to sustain permitted uses and activities.

Conservancy Recreation (CR) Environment

GOAL

- SA G29** The purpose of the Conservancy Recreation Environment is to preserve and enhance the shoreline environment while providing opportunities for shoreline recreation.

POLICIES

- SA P57** Prioritize public access, water-dependent recreation, and other water-oriented uses compatible with ecological protection.
- SA P58** Locate public access and public recreation only where the impacts on ecological functions can be effectively mitigated.

Conservancy Waterway (CW) Environment

GOAL

- SA G30** The purpose of the Conservancy Waterway Environment is to preserve and enhance the shoreline environment while providing access to the shoreline and water by watercraft.

POLICIES

- SA P59** Provide navigational access to adjacent properties, and access to and from land for the loading and unloading of watercraft and temporary moorage.
- SA P60** Allow in- and overwater structures only where needed for navigational purposes, temporary moorage, minor vessel repair, pedestrian bridges, and/or ecological restoration.
- SA P61** Minimize impacts on navigation, public views, and ecological functions.

Urban Shoreline Environments

GOAL

- SA G31** The urban shoreline environments are intended to provide for increased development of the shoreline for residential, commercial, and industrial uses while protecting ecological functions.

Urban Commercial (UC) Environment

GOAL

- SA G32** The purpose of the Urban Commercial Environment is to provide for water-oriented uses of the shoreline and for uses that are not water oriented when shoreline restoration and enhancement or public access is provided.

POLICIES

- SA P62** Allow uses that are not water oriented only when in combination with water-dependent uses or in limited situations where they do not conflict with or limit opportunities for water-dependent uses or on sites where there is no direct access to the shoreline.
- SA P63** Require visual access to the water through view corridors or other means for commercial and larger multifamily residential projects.
- SA P64** Provide for public access to the shoreline, and require shoreline environmental restoration and enhancement for uses that are not water dependent.

Urban General (UG) Environment

GOAL

- SA G33** The purpose of the Urban General Environment is to provide for commercial and industrial uses in the shoreline district where water access is limited.

POLICIES

- SA P65** Allow commercial and industrial uses that are not water dependent or water related.
- SA P66** Require visual public access where feasible.

Urban Harborfront (UH) Environment

GOAL

- SA G34** The purpose of the Urban Harborfront Environment is to provide for water-oriented uses (uses that are water-dependent, water-related, or water-enjoyment, or a combination of such uses) of the shoreline and for a mix of uses that are water oriented and not water oriented on lots where shoreline restoration and enhancement or public access is provided.

POLICIES

- SA P67** Allow a mix of uses in recognition of this environment's roles in tourism and transportation, while ensuring a high degree of public access and recognizing the historic, environmental, and anthropogenic nature of this area.
- SA P68** Allow uses that are not water oriented as part of mixed-use developments or in circumstances where they do not conflict with or limit opportunities for water-oriented uses.
- SA P69** Allow uses that are not water oriented on sites where there is no direct access to the shoreline.
- SA P70** Allow uses that reflect the diversity of development in the area and support adjacent retail and the tourism industry. On waterfront lots, provide public access and opportunities for large numbers of people to access and enjoy the water in the form of restaurants and water-dependent recreational activities. Allow a broader range of uses on upland lots to support the tourism industry and retail core.
- SA P71** Maintain and enhance views of the water and the landforms beyond the water to augment the harborfront's pedestrian environment and status as an important waterfront destination. Encourage connections to east-west corridors and waterfront trails.
- SA P72** Encourage and provide for physical public access to the water, where appropriate and feasible.
- SA P73** Development should support or enhance the existing historic character of the urban harborfront while balancing the need for ecological enhancement.

Urban Industrial (UI) Environment

GOAL

- SA G35** The purpose of the Urban Industrial Environment is to provide for water-dependent and water-related industrial uses on larger lots.

POLICIES

- SA P74** Allow uses that are not water dependent to locate on waterfront lots in limited circumstances and in a limited square footage on a site as part of development that includes water-dependent or water-related uses, where it is demonstrated that the allowed uses will benefit water-dependent uses and where the use will not preclude future use by water-dependent uses.
- SA P75** Allow uses that are not water dependent or water related where there is no direct access to the shoreline.

Urban Maritime (UM) Environment

GOAL

- SA G36** The purpose of the Urban Maritime Environment is to provide for water-dependent and water-related industrial and commercial uses on smaller lots.

POLICIES

- SA P76** Design public access to minimize interference with water-dependent, water-related, and industrial uses, and encourage that public access be located on street ends, parks, and other public lands.
- SA P77** Allow uses that are not water dependent to locate on waterfront lots in limited circumstances and in a limited square footage on a site as part of development that includes water-dependent or water-related uses, where it is demonstrated that the allowed uses will benefit water-dependent uses and where the use will not preclude future use by water-dependent uses.
- SA P78** Allow uses that are not water dependent or water related on lots where there is no direct access to the shoreline.

Urban Residential (UR) Environment

GOAL

- SA G37** The purpose of the Urban Residential Environment is to provide for residential use in the shoreline district when it can be developed in a manner that protects shoreline ecological functions.

POLICIES

- SA P79** Provide for single-family residential use of the shoreline in areas that are not suited for industrial and commercial use, habitat protection, or public access.

- SA P80** Provide development standards that allow residential development and protect ecological functions, such as shoreline armoring standards and structure setback regulations.
- SA P81** Multifamily development is not a preferred use in the shoreline district and should be limited to locations where allowed as of January 2011.
- SA P82** Require public access as part of multifamily development of greater than four units.
- SA P83** Provide for access, utilities, and public services to adequately serve existing and planned development.

Shorelines of Statewide Significance

Discussion

In addition to the goals and policies of each shoreline environment, the following policies apply to all shorelines of statewide significance under the jurisdiction of the Shoreline Master Program, which include: Puget Sound, the Duwamish River (shorelines from the south city limits north to South Massachusetts Street on the east side and Southwest Bronson Street on the west side, and including Harbor Island and the East and West Duwamish Waterways), Lake Washington, and Union Bay to the Montlake Bridge, as illustrated in Shoreline Figure 1.

POLICIES

- SA P84** Protect the ecology of natural beaches and fish migration routes, including the natural processes associated with feeder bluffs.
- SA P85** Encourage and enhance shoreline recreational activities, particularly in developed parks.
- SA P86** Provide for quality public access to the shoreline.
- SA P87** Preserve views of Puget Sound and the landforms beyond, as well as views of Lake Washington and Union Bay.
- SA P88** Preserve and enhance the resources of natural areas and fish migration routes, feeding areas, and spawning areas.

Shoreline Figure 1

Seattle Shorelines

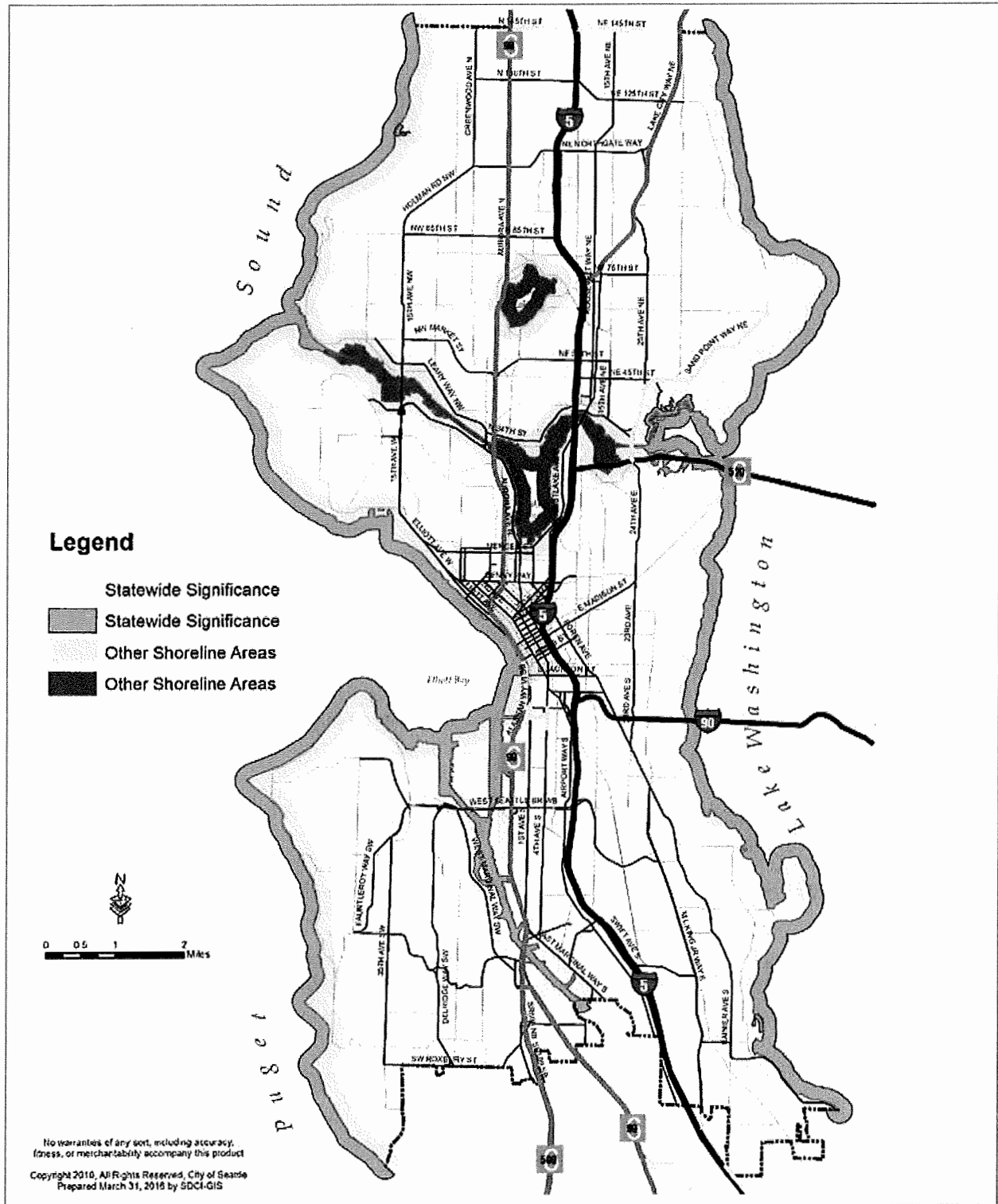

Height in the Shoreline District

POLICIES

SA P89 The thirty-five-foot height limit provided in the Shoreline Management Act shall be the standard for maximum height in the Seattle shoreline district. Exceptions in the development standards of a shoreline environment may be made consistent with the Act and with underlying zoning and special districts where

1. a greater height will decrease the impact of the development on the ecological condition,
2. a greater height will not obstruct views from public trails and viewpoints,
3. a greater height will not obstruct shoreline views from a substantial number of residences on areas adjoining the “shorelines of the state” as defined in RCW 90.58.030(1)(g) that are in Seattle and will serve a beneficial public interest, or
4. greater height is necessary for bridges, or equipment of water-dependent or water-related uses or manufacturing uses.

SA P90 Heights lower than thirty-five feet

1. shall be the standard for structures overwater, and
2. where a reduced height is warranted because of the underlying residential zone, or
3. where a reduced height is warranted because public views or the views of a substantial number of residences on areas adjoining the “shorelines of the state” as defined in RCW 90.58.030(1)(g) that are in Seattle could be blocked.

Shoreline Master Program Process

GOAL

SA G38 Continue shoreline planning by periodically updating the inventory, goals, policies, and regulations to respond to changing priorities and conditions in Seattle’s shorelines.

POLICY

SA P91 Conduct periodic assessments of the performance of and the need for change in the Shoreline Master Program.

Glossary



Term	Definition
accessory dwelling unit	A housing unit that is in addition to the primary residence on a site. An accessory unit may be attached to or detached from the primary residence.
affordable housing	A housing unit for which the occupant(s) are paying no more than 30 percent of household income for gross housing costs, which includes rent and basic utilities.
area median income (AMI)	The annual median family income for the Seattle area, as published by the US Department of Housing and Urban Development, with adjustments for household size, assuming 1 person for a studio apartment and 1.5 people per bedroom for other units.
buffer area	An area of land separating two distinct land uses that softens or mitigates the effects of one land use on the other. Also, an area that protects sensitive environmental features from development activity.

built city	A city with little or no undeveloped land. Seattle is considered a built-out city because nearly all its land is platted and served by roads, water, and sewer and because very little of the land is vacant.
capital facilities	Physical features that support urban development; usually refers to features provided by public agencies, such as roads, developed parks, municipal buildings, and libraries.
capital improvement program (CIP)	The portion of the City's budget that describes revenue sources and expenditures for funding capital facilities.
carbon neutral	Making no net release of carbon dioxide into the atmosphere.
Center City	The four contiguous urban centers: Downtown, First Hill/Capitol Hill, South Lake Union, and Uptown.
climate change	A change in global or regional climate patterns, in particular a change apparent from the mid to late twentieth century onward and attributed largely to the increased levels of atmospheric carbon dioxide produced by the use of fossil fuels.
commercial land use	Activities that include the buying and selling of commodities and services. These activities are usually housed in office or retail spaces.
complete streets	Streets that provide appropriate accommodation for pedestrians, bicyclists, transit riders, and people of all abilities, while promoting safe operation for all users.
conditional use	A use that may locate within a zone only upon taking measures to address issues that may make the use detrimental to public health, safety, and welfare, or issues that may impair the integrity and character of the zoned district.
Countywide Planning Policies	The Growth Management Act requires that counties prepare countywide planning policies (CPPs) to ensure that city and county comprehensive plans are consistent. The CPPs define the county's urban growth boundary and set growth targets for all jurisdictions in the county, as well as set expectations for the growth of urban centers and for transportation priorities. The King County Countywide Planning Policies were developed and recommended by the Growth Management Planning Council, a group of elected officials who represent all the jurisdictions in the county.
cultural resources	Buildings, objects, features, locations, and structures with scientific, historic, and societal value.
demand management	The strategy of reducing demand for services such as energy, water, or vehicle trips, rather than increasing production to ensure adequate supply.
density	A measurement of the concentration of development on the land, often expressed in the number of people, housing units, or employees per acre. In Seattle, housing density ranges from areas that contain primarily single-family houses on large lots to highrise apartment buildings in one of the city's urban centers.
development pattern	The arrangement of buildings, lots, and streets in an urban environment.
development regulations	Rules the City uses to control buildings or land uses, primarily in the Land Use Code.

displacement	The involuntary relocation of residents or businesses from their current location. Direct displacement is the result of eviction, acquisition, rehabilitation, or demolition of property, or the expiration of covenants on rent/income-restricted housing. Indirect displacement occurs when residents or businesses can no longer afford escalating rents or property taxes.
distributed systems	Systems where the supply of water, energy, or other resources come from many sources, such as small solar energy generators or the capture of waste heat, rather than from a central source, such as a power plant.
economic mobility	Economic mobility is the ability of an individual, family, or some other group to improve (or lower) their economic status—usually measured in income.
environmentally critical area (ECA)	Locations in the city that provide critical environmental functions, such as wetlands protecting water quality and providing fish and wildlife habitat. ECAs also include areas that represent particular challenges for development due to geologic or other natural conditions, such as steep slopes, landslide-prone areas, and liquefaction areas.
floor area ratio (FAR)	The gross floor area of a building divided by the total area of the site. For example, a twenty-thousand-square-foot building on a site with an area of ten thousand square feet has a floor area ratio of 2.0. This applies regardless of the building's height, so the building could have five stories of four thousand square feet each or two stories of ten thousand square feet each.
frequent transit	Generally, bus or train service that arrives at intervals of fifteen minutes or less.
Future Land Use Map (FLUM)	A required component of a comprehensive plan in Washington that shows the proposed physical distribution and location of the various land uses during the planning period.
goal	In the planning process, a goal identifies a desired end state.
green streets	A green street is a street right-of-way that includes a variety of design and operational treatments to give priority to pedestrian circulation and open space over other transportation uses. The treatments may include sidewalk widening, landscaping, traffic-calming, and other pedestrian-oriented features.
greening	Building or improving infrastructure in ways that will reduce environmental impacts—for instance, by using soil and vegetation to infiltrate and cleanse stormwater.
Growth Management Act (GMA)	The Growth Management Act (GMA) is the state law that requires local governments to prepare comprehensive plans. It establishes state goals, sets deadlines for compliance, gives direction on how to prepare local plans and development regulations, and calls for early and continuous public participation. (RCW 36.70A)
healthy communities	Neighborhoods where there are opportunities for people to be physically active by walking or biking to goods and services; where there is access to parks, open space, and healthful food; and where people can engage with others.
high-capacity transit	In Seattle, high-capacity transit consists of both rail and rubber-tired transit modes that can operate in exclusive rights-of-way or in mixed traffic. It can include technologies such as light rail or bus rapid transit.

historic district	Seattle has established eight historic districts: Ballard Avenue, Columbia City, Fort Lawton, Harvard-Belmont, International District, Pike Place Market, Pioneer Square, and Sand Point. A citizens' board or the Landmarks Preservation Board reviews the appearance of development activity in these districts to maintain the historical integrity of structures and public spaces.
historic landmark	A property that has been designated by the City as an important resource to the community, city, state, or nation. Designated landmark properties in Seattle include individual buildings and structures, vessels, landscapes and parks, and objects such as street clocks and sculptures. The Seattle Landmarks Preservation Board is responsible for determining which properties meet the standards for landmark designation.
hub urban village	A geographic area designated by the City where both housing and job growth are expected to occur, at somewhat lower scales and densities than in urban centers.
human-scale development	Buildings in which features such as steps, doorways, railings, fixtures, and walking distances fit an average person well.
impervious surface	A surface that cannot absorb water, such as asphalt or concrete.
income levels	<p>“Lower-income” includes three subcategories:</p> <ul style="list-style-type: none"> • Extremely low-income: a household whose income is equal to or less than 30 percent of median income; also refers to housing that extremely low-income households can afford. • Very low-income: a household whose income is greater than 30 percent of median income and equal to or less than 60 percent of median income; also refers to housing that very low-income households can afford. • Low-income: a household whose income is greater than 60 percent of median income and equal to or less than 80 percent of median income; also refers to housing that very low-income households can afford. <p>Moderate-income: a household whose income is greater than 80 percent of median income and equal to or less than 100 percent of median income; also refers to housing that moderate-income households can afford.</p> <p>Middle-income: a household whose income is greater than 100 percent of median income and equal to or less than 150 percent of median income; also refers to housing that middle-income households can afford.</p>
industrial land use	Activities that include production, distribution, and repair of goods; includes uses such as factories, container terminals, rail yards, warehouses, and repair of heavy equipment.
industry cluster	A geographical concentration of similar or related industries that gain economic advantages from their location.
infill development	Development of vacant or underused land within areas that are already largely developed.
infrastructure	Public services and facilities such as sewage-disposal systems, water-supply systems, other utility systems, schools, roads, bicycle lanes, sidewalks, and transit systems.

intelligent transportation systems (ITS)	Systems in which information and communication technologies are used to facilitate transportation operations; ITS may include technologies such as basic management systems, including car navigation, traffic signal control systems, and variable message signs.
Land Use Code	The portion of the Seattle Municipal Code that contains regulations governing development activities. The Land Use Code describes the processes and standards that apply for each zone in the city.
landscape screening	Use of trees, shrubs, or other plantings to block the view of nearby activities.
life cycle costs	A method of evaluating a capital investment that takes into account the sum total of all costs associated with the investment over the lifetime of the project.
liquefaction	The transformation of loose, wet soil from a solid to a liquid state, often as a result of ground shaking during an earthquake.
livability	Livability is the sum of the factors that add up to a community's quality of life, including built and natural environments, economic prosperity, social stability and equity, educational opportunity, and cultural, entertainment, and recreational possibilities.
major institutions	Colleges, universities, and hospitals that the City regulates through specific master plans developed in cooperation with the surrounding communities.
manufacturing/ industrial center	One of the two areas in Seattle that the Comprehensive Plan designates as places where industrial activities are encouraged and nonindustrial activities are either prohibited or strictly limited.
marginalized populations	Low-income people, people of color, and non-native English speakers. These groups have often historically been underserved and underrepresented in City processes.
master plan	A document that describes the long-term expectations for growth on a large property controlled by a single entity, such as the campus of a college or hospital.
mixed-use	Development that contains residential use plus some other, usually commercial use, such as office or retail.
multifamily land use	Freestanding buildings composed of two or more separate living units, with each unit having its own bedroom, kitchen, and bathroom facilities.
natural drainage systems	The use of trees, plants, ground covers, and soils to manage stormwater runoff from hard surfaces (like roofs, roads, parking lots, and sidewalks) in ways that mimic nature—slowing and cleaning polluted runoff close to its source and reducing the volume of runoff by allowing it to soak back through the soil and recharge groundwater.
neighborhood character	The unique look and feel of a particular area within the city. This is a subjective concept—one that varies not only by neighborhood but also by each person's view of that neighborhood.
nonconforming use	A use or structure that was valid when brought into existence but that does not meet subsequent regulations. Typically, nonconforming uses are permitted to continue, subject to certain restrictions.
Official Land Use Map	A map adopted by ordinance that shows the locations of the designated zones in the city.

open space	Any parcel or area of land that is essentially unimproved and devoted to the preservation of natural resources, the managed production of resources, or outdoor recreation.
overlay district	A land use designation on a zoning map that modifies the underlying designation in some specific manner. Overlay zones often deal with areas that have special characteristics, such as shoreline areas or historical areas.
parklet	A sidewalk extension, usually in the parking lane, that provides more space and amenities for people using the street.
pedestrian-oriented commercial areas	Commercial zones where the development standards are intended to make walking an attractive way of getting around. These include the Neighborhood Commercial (NC) and Seattle Mixed (SM) zones.
placemaking	A people-centered approach to the planning, design, and management of public spaces such as parks, plazas, and streets that helps give activity and identity to those spaces.
policy	A statement of principle intended to guide future action in a way that will help achieve an adopted goal or goals.
rent/income-restricted housing	Housing with a regulatory agreement, covenant, or other legal document on the property title that sets a limit on the income of households that may rent the unit(s) and controls the rent(s) that may be charged for a specified period of time.
residential urban village	A geographic area designated by the City where primarily housing growth is expected to occur, at somewhat lower scales and densities than in hub urban villages.
resilience	The capacity to adapt to changing conditions and to maintain or regain functionality and vitality in the face of stress or disturbance. The ability of individuals, households, communities, and regions to maintain livable conditions in the event of natural disasters, loss of power, or other interruptions in normally available services.
rezone criteria	A set of considerations specified in the Land Use Code that helps determine the appropriate locations for applying the City's various zoning designations.
right-of-way	A strip of land occupied or intended to be occupied by certain transportation and public use facilities, like roads, railroads, and utility lines.
setback	The minimum distance required by zoning regulations to be maintained between two structures or between a structure and a property line.
shared parking	Parking spaces that may be used by more than one user, such as a parking lot that is used by a church on weekends and by commuters during the week.
single-family land use	Stand-alone structures on a parcel of land containing only one living unit.
single-occupant vehicle	A privately operated vehicle whose only occupant is the driver.
smart parking	A system that uses electronic signs to direct incoming drivers to available parking.
social equity	Fair access to livelihood, education, and resources; full participation in the political and cultural life of the community; and self-determination in meeting fundamental needs.

special review district	An area of the city where unique development standards and review procedures apply, such as Pioneer Square.
stewardship	Responsibility for monitoring or encouraging actions that affect the natural or built environment.
stormwater	Water that falls as rain and flows across the ground. In an urban area, most stormwater is directed to drains that collect the water and eventually direct it to streams, lakes, or other large water bodies.
sustainable communities	Areas of development that are able to meet the needs of growth, while not exhausting the natural resources that will be necessary for future generations.
transit-oriented communities	Moderate- to higher-density development located within an easy walk of a major transit stop, generally with a mix of residential, employment, and shopping opportunities designed for pedestrians, without excluding automobiles.
urban centers	Key features of the regional growth strategy; relatively small areas that are expected to accommodate the highest densities of development for both housing and employment.
urban forest	The trees and lower-growing plants that are found on public and private property within the city. This includes developed parks and natural areas, as well as the trees along streets and in yards.
urban growth boundary	An officially adopted and mapped line dividing land to be developed from land to be protected for natural or rural uses. Under the Growth Management Act, sewers are not permitted to be extended beyond the urban growth boundary.
urban villages	Areas designated in Seattle's Comprehensive Plan for future growth. These are generally areas that include long-standing neighborhood business districts along with zoning that can accommodate further development. The three types of urban villages in Seattle are urban centers, hub urban villages, and residential urban villages.
zones	Designations adopted by City ordinance and applied to areas of land to specify allowable uses for property and size restrictions for buildings within these areas.

Neighborhood Plans

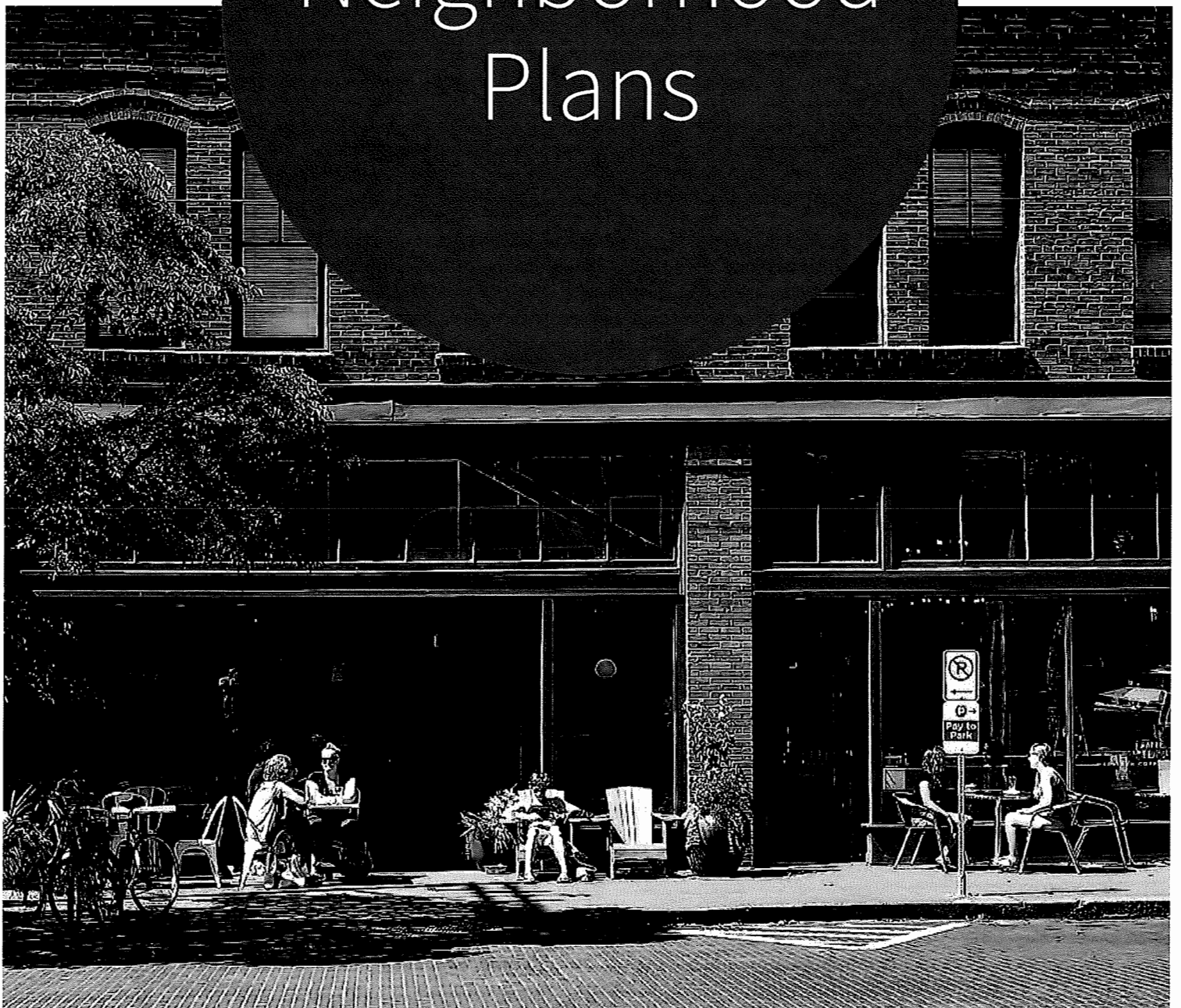

Adopted Neighborhood Plans

Admiral

LAND USE GOALS

- A-G1** Land use within the residential urban village that conforms to Admiral's vision of a neighborhood with a pedestrian-oriented small-town atmosphere.
- A-G2** The Admiral neighborhood is predominantly a single-family housing community.

LAND USE POLICIES

- A-P1** Encourage development that conforms with the neighborhood's existing character and scale, and further promotes a pedestrian-friendly environment.
- A-P2** Maintain the character and integrity of the existing single-family zoned areas by maintaining current single-family zoning outside the urban village on properties meeting the locational criteria for single-family zones.
- A-P3** Seek to ensure community involvement in land use code changes.
- A-P4** The special L3 and L4 locational criteria for the evaluation of rezones to the L3 and L4 designations inside of urban villages shall not apply in the Admiral Residential Urban Village.

TRANSPORTATION GOALS

- A-G3** A residential urban village with an adequate parking supply to serve customers, residents and employees.
- A-G4** People walk, bicycle, or ride buses when traveling inside the Admiral neighborhood.

TRANSPORTATION POLICIES

- A-P5** Future developments and significant remodels should seek to provide adequate parking.
- A-P6A** Strive to attain adequate levels of parking that serves the urban village and adjacent transitional areas, and to discourage parking from commercial areas or other activity centers from spilling over onto residential streets.
- A-P6B** Work with the community in addressing parking issues.
- A-P7** Seek to anticipate and address future parking needs.
- A-P8** Strive to eliminate local traffic safety hazards, and discourage cut-through traffic on residential streets.
- A-P9** Seek to ensure that streets are clean and attractive, are calmed, and have sufficient capacity and a high level of service.
- A-P10** Seek to improve pedestrian and vehicular traffic safety and convenience.
- A-P11** Seek to anticipate and address future traffic circulation needs.
- A-P12** Seek to improve water-based commuting connections from West Seattle to Downtown.
- A-P13** Seek to assure that transit routing, scheduling, and transfer points meet neighborhood needs.
- A-P14** Seek to provide good access to and from West Seattle.
- A-P15** Work with the Admiral neighborhood to minimize loss and damage from landslides and land erosion.
- A-P16** Seek to improve facilities for bicycles, skateboards, and pedestrians.
- A-P17** Seek to increase community awareness of emerging transportation technologies.

HOUSING POLICY

- A-P18** Seek to ensure that public-assisted housing is well integrated within the Admiral neighborhood by seeking to keep it dispersed, small-scale, and aesthetically integrated, in keeping with Admiral's small-town image.

HUMAN SERVICES GOAL

- A-G5** A neighborhood with adequate community, educational, recreational, safety, and social services to serve its residents.

ADMIRAL Residential Urban Village

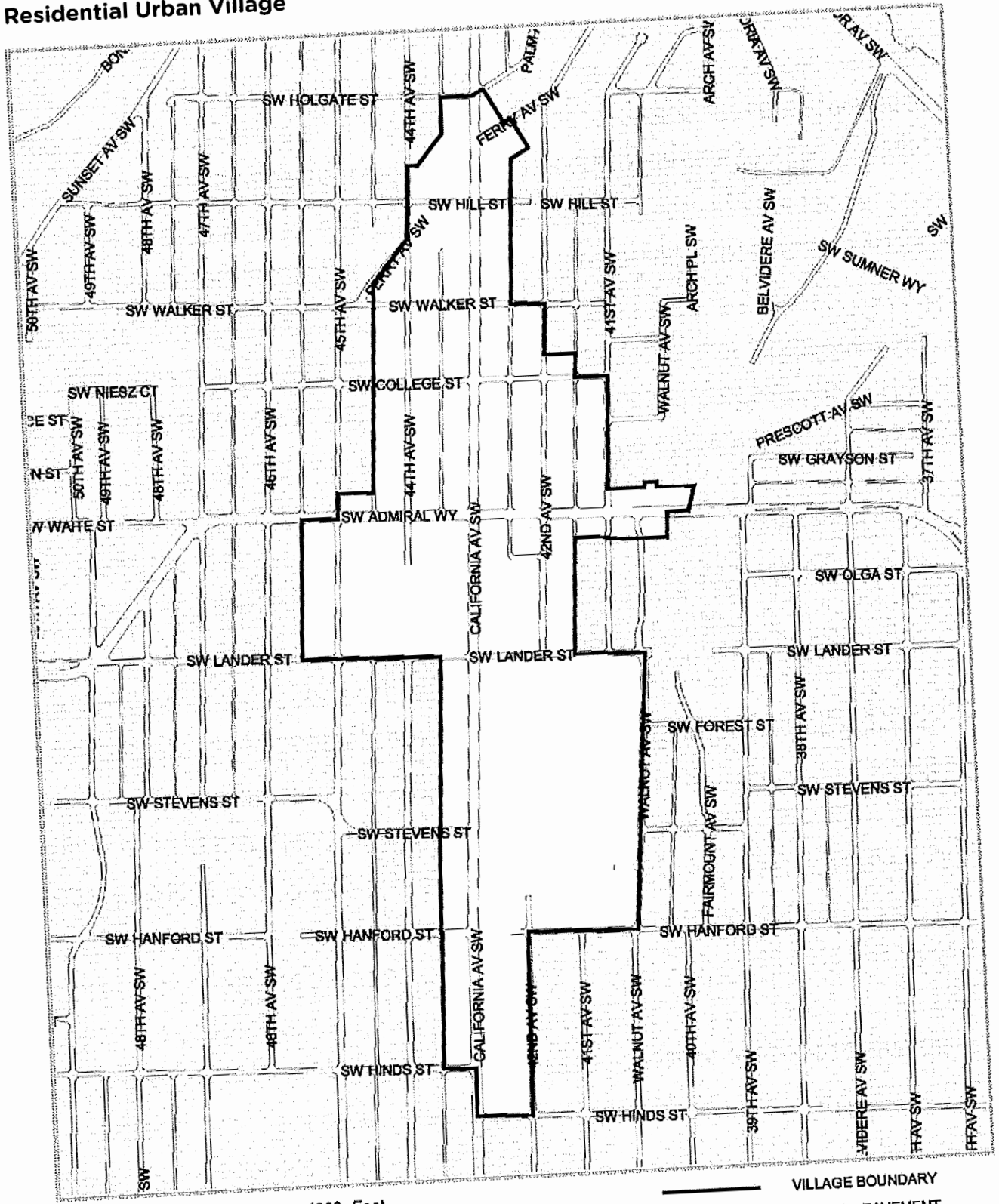

HUMAN SERVICES POLICIES

- A-P19** Support local efforts to improve the safety of the Admiral neighborhood.
- A-P20** Seek to provide adequate fire and police service for the planning area.

CAPITAL FACILITIES POLICIES

- A-P21** Seek to ensure neighborhood involvement, through the involvement of community organizations, in the identifying and siting of publicly sponsored capital projects, including those that impact the natural environment.
- A-P22** Strive for excellent coordination between City departments, and between the City and the County, especially on projects that impact the natural environment.

UTILITIES GOALS

- A-G6** The neighborhood is well served with infrastructure and capital improvements.
- A-G7** Pollution levels have been reduced in the Admiral neighborhood.

UTILITIES POLICIES

- A-P23** Seek to ensure the adequacy of neighborhood's utilities to meet ongoing growth.
- A-P24** Seek to provide levels of lighting for streets and sidewalks that enhance safety.
- A-P25** Seek to clean up noise and air pollution, and litter and graffiti.

ECONOMIC DEVELOPMENT POLICIES

- A-P26** Seek to encourage retail services desired by the community.
- A-P27** Seek to advocate for the health and diversity of merchants located in the Admiral business district.

COMMUNITY BUILDING GOAL

- A-G8** The City and the Admiral neighborhood continue to collaborate in planning efforts.

COMMUNITY BUILDING POLICY

- A-P28** Seek to promote community-building opportunities for Admiral neighborhood residents.

CULTURAL RESOURCES POLICY

- A-P29** Encourage public art that reflects the heritage and lifestyle of the Admiral neighborhood.

PARKS & OPEN SPACE GOAL

- A-G9** Open spaces, parks, and playgrounds in the Admiral planning area have been preserved and maintained.

PARKS & OPEN SPACE POLICIES

- A-P30** Work with existing neighborhood groups to seek to ensure that programming of park facilities reflects the needs of the neighborhood.
- A-P31** Seek to provide open space within the Admiral neighborhood to serve the community's needs and to protect critical areas and natural habitat.
- A-P32** Seek to preserve the integrity of the Olmsted design at Hiawatha Park.
- A-P33** Seek to preserve and extend the neighborhood's tree canopy.
- A-P34** Seek to provide convenient pedestrian access to Admiral's parks, playgrounds, and open space.

COMMUNITY CHARACTER GOALS

- A-G10** A residential urban village with a vibrant and attractive character.
- A-G11** A high-quality, diverse neighborhood where developers and businesses benefit from sustaining excellence and from filling local needs.
- A-G12** A neighborhood with high expectations and standards for public services, building, and landscaping.

COMMUNITY CHARACTER POLICIES

- A-P35** Support neighborhood involvement in land use decisions, especially in decisions related to variances and conditional uses.
- A-P36** Seek to ensure that the designs of private development and public spaces support each other to enhance and reinforce Admiral's identity.



Aurora-Licton

DESIGNATION OF THE AURORA-LICTON RESIDENTIAL URBAN VILLAGE GOAL

- AL-G1** An Aurora-Licton Residential Urban Village that is a vibrant residential community, with a core of multifamily housing, pedestrian-oriented neighborhood retail shops and services, and open space clustered immediately east of Aurora Avenue North. The core area should be fully accessible to residents east and west of Aurora Avenue.

DESIGNATION OF THE AURORA-LICTON RESIDENTIAL URBAN VILLAGE POLICIES

- AL-P1** Maintain the current balance of residential and commercial areas within the urban village boundaries. Consider future zoning changes that would reduce conflicts between adjacent areas; promote the development of a neighborhood-serving and pedestrian-oriented commercial core and promote transitions between single-family areas and commercial areas.
- AL-P2** Protect the character and integrity of Aurora-Licton's single-family areas within the boundaries of the Aurora-Licton urban village.
- AL-P3** Encourage development to enhance the neighborhood's visual character through use of tools such as citywide and Aurora-Licton neighborhood-specific design guidelines, including Aurora Avenue specific guidelines.
- AL-P4** Encourage the development of enhanced transit connections to the village core, the Northgate transit hub, and the Northgate high-capacity transit station.

COMMUNITY CENTER GOALS

- AL-G2** A developed center for community activities, recreation, and environmental education making strategic use of existing public facilities within the core of the urban village.
- AL-G3** Reduced localized and upstream flooding, and enhance runoff water quality with a well-designed drainage system, including Licton Creek, that is in harmony with wildlife use and habitat, and that is incorporated into other recreational activities and site uses.
- AL-G4** Excellent educational facilities and programs for students and families within the urban village.

AURORA-LICTON SPRINGS Residential Urban Village

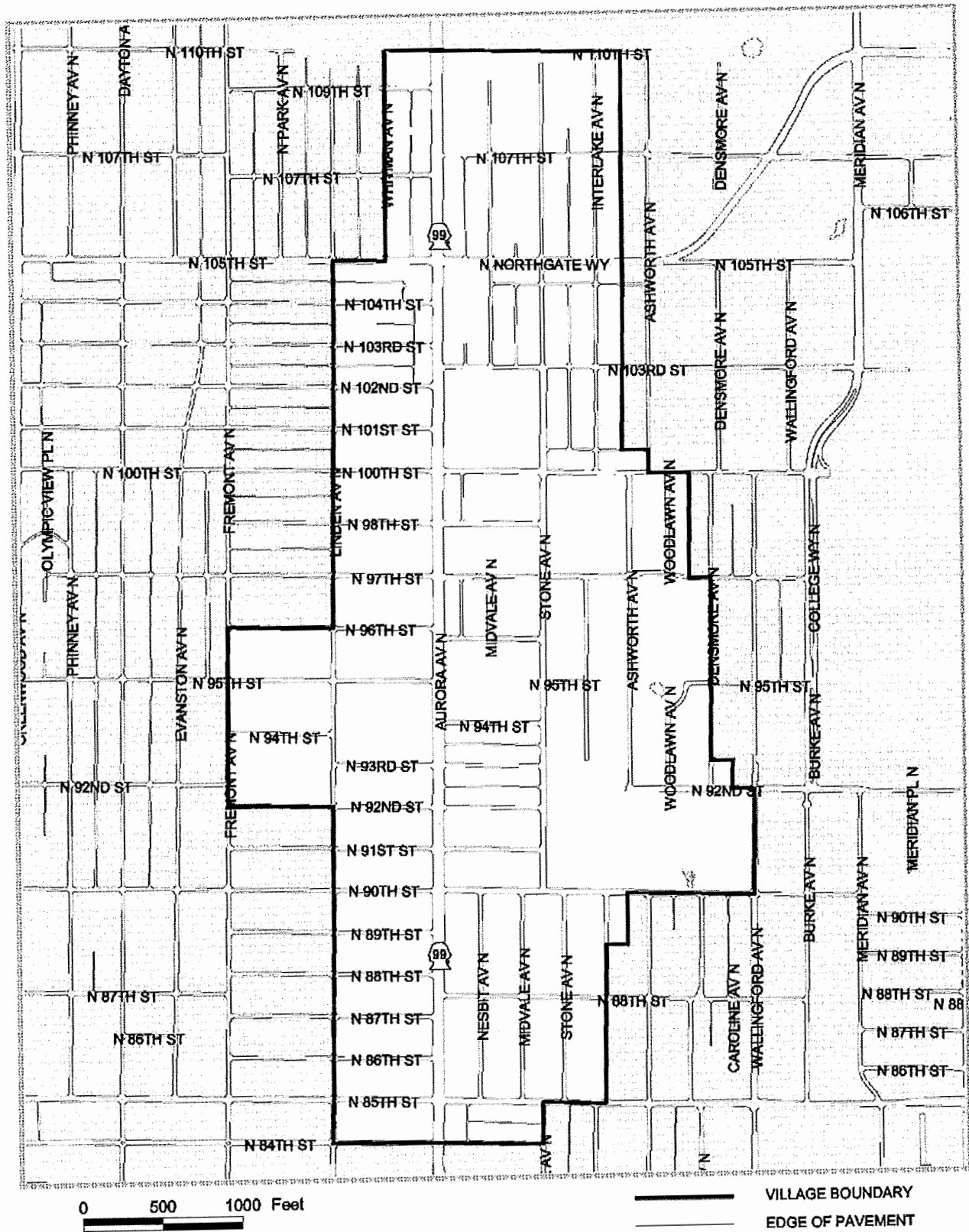

COMMUNITY CENTER POLICIES

- AL-P5** Seek to provide a range of active and passive recreation and community activities within the heart of Aurora-Licton. Encourage multiple uses of public facilities within the Aurora-Licton community, including the Wilson-Pacific School.
- AL-P6** Encourage the continued presence of public school classroom facilities in the Aurora-Licton Residential Urban Village.
- AL-P7** Explore opportunities to partner with other public agencies, including the Seattle Public School District, to provide for community use of public facilities.
- AL-P8** Strive to enhance the drainage system through such activities as daylighting of Licton Springs Creek.
- AL-P9** As modifications to waterways are designed, seek to balance enhanced drainage capacity, natural habitat, historic character, and environmental significance.
- AL-P10** Strive to develop a central repository for community planning documents, information about the area's history, and community resource information at a permanent location near the core of the urban village. Such a space should be open and accessible to the public during regular hours.
- AL-P11** Encourage community environmental education at sites such as the Wilson-Pacific site, Pilling's Pond, and Licton Springs Park.

AURORA-LICTON NEIGHBORHOOD COMMERCIAL CENTERS GOAL

- AL-G5** One or more vibrant, safe, and attractive mixed-use commercial area that provides the immediate neighborhood with convenient access to retail goods and services, and that minimizes impacts, such as parking, traffic, crime, and noise, to adjacent residential areas.

AURORA-LICTON NEIGHBORHOOD COMMERCIAL CENTERS POLICIES

- AL-P12** Encourage neighborhood-oriented retail stores and services in the urban village that are attractive and accessible to the surrounding community. Recognize the importance of and support existing businesses in the community.
- AL-P13** Encourage the development of pedestrian-friendly pathways, which will enhance and support new pedestrian-oriented commercial activity and maximize pedestrian access to public facilities.
- AL-P14** Encourage new pedestrian-oriented commercial activity to locate near pedestrian crossings, transit facilities, and along pedestrian routes. New development should provide safe and attractive pedestrian access.
- AL-P15** Encourage the location and development of off-street parking underground or behind buildings.

AURORA AVENUE NORTH GOALS

- AL-G6** Safe and convenient crossings of Aurora Avenue North that logically link transit stops and retail nodes. Safe and accessible pedestrian routes along Aurora Avenue North and adjacent side streets leading to the crossings.
- AL-G7** A transformed Aurora Avenue North that is an aesthetically attractive regional highway and commercial corridor that acts as a gateway to the Aurora-Licton Residential Urban Village and to other communities, and that is safe for pedestrians, motorists, business operators, and employees.

AURORA AVENUE NORTH POLICIES

- AL-P16** Encourage provision of safe and attractive passage for pedestrians along Aurora Avenue North and safe means for pedestrians to cross Aurora Avenue North at locations that connect transit stops, retail nodes, and pedestrian routes, including relocated, enhanced, and/or additional crosswalks. Discourage the development of new pedestrian underpasses. If additional underpasses are proposed for Aurora, they should be designed to minimize public safety problems.
- AL-P17** Identify means of enhancing the visual character of Aurora Avenue North including streetscape improvements that beautify and enhance functionality. Seek to maintain the important cultural, historic, and visual landmarks while also encouraging redevelopment of deteriorated areas near Aurora Avenue North.

NEIGHBORHOOD CONNECTIONS GOAL

- AL-G8** A comprehensive network is established of safe and attractive pedestrian and bicycle connections to transit, between commercial and residential areas, and between the urban village and nearby destinations such as North Seattle Community College and the proposed Northgate Sound Transit Station.

NEIGHBORHOOD CONNECTIONS POLICIES

- AL-P18** Work with the community toward providing safe and attractive pedestrian and bicycle access, including sidewalks, on all streets throughout the urban village, providing connections to destinations such as the future Northgate Sound Transit Station, Northgate Mall, the future Northgate library, the Greenwood Library, Green Lake Park, and Bitter Lake Community Center.
- AL-P19** Seek to incorporate bicycle improvements into plans for key pedestrian streets in the Aurora-Licton Residential Urban Village.
- AL-P20** Strive to develop improvements to Stone Avenue in order to create a neighborhood corridor that encourages safe pedestrian, bicycle, transit, and auto use, and supports the neighborhood, retail activities, and the existing businesses along this street.

- AL-P21** Encourage enhanced transit service between Downtown Seattle and the Aurora-Licton Urban Village. Seek to coordinate improvements to transit service with crosswalks and pedestrian, bicycle, and transit shuttle routes.
- AL-P22** Consider the development of local transit shuttle service within the urban village, and to nearby destinations, such as Northgate.
- AL-P23** Seek to enhance and preserve alleys as safe, efficient local access corridors throughout the Aurora-Licton Planning Area. With the community seek to enhance alleys as safe pedestrian corridors to the extent consistent with citywide policies. Work to develop minimum standards for alley construction, lighting, drainage, and maintenance.

PARKS & RECREATION GOAL

- AL-G9** Excellent active and passive recreation opportunities are accessible to all residents in the planning area.

PARKS & RECREATION POLICIES

- AL-P24** Work to develop new open space and recreation opportunities in areas that are currently not well served by park facilities.
- AL-P25** Seek opportunities to enhance the usability and accessibility of existing parks and open space areas in the Aurora-Licton Planning Area.
- AL-P26** Seek to incorporate opportunities for community environmental education at public open spaces.

ARTS & LIBRARY SERVICES GOAL

- AL-G10** Excellent access to information, arts, cultural activities, and library services in the Aurora-Licton neighborhood.

ARTS & LIBRARY SERVICES POLICIES

- AL-P27** Promote the creation and display of public art, especially art that reflects the historical and cultural aspects of the surrounding environment.
- AL-P28** Encourage the creation of areas for local artists to work and areas for the public display of art.
- AL-P29** Provide enhanced library access and services to Aurora-Licton residents. Explore shared use opportunities with existing local educational facilities.

PUBLIC SAFETY GOAL

AL-G11 A neighborhood where all people feel safe from the threat of injury and criminal activity.

PUBLIC SAFETY POLICIES

AL-P30 Strive to reduce the fear of crime and the potential for criminal activity through such design tools as lighting, fencing, building, and landscaping.

AL-P31 Explore the development of programs to reduce public health hazards resulting from criminal activity.

GENERAL TRAFFIC MANAGEMENT & PEDESTRIAN ACCESS POLICIES

AL-P32 Work with residents, property and business owners, and surrounding neighborhoods toward the development of strategies to reduce congestion and enhance traffic safety.

AL-P33 Seek to minimize impacts of public vehicles on neighborhood streets through tools such as designating primary routes and traffic patterns, developing parking management systems, and providing special signalization.

REGIONAL TRANSPORTATION GOAL

AL-G13 Excellent multimodal transportation services for the neighborhood, connecting to Downtown Seattle, other neighborhoods, and regional destinations, with minimal negative impacts to residential areas.

REGIONAL TRANSPORTATION POLICIES

AL-P34 Work with the State and transit providers to develop connections between the Northgate Transit Center, proposed Sound Transit light rail system, and the Aurora-Licton Urban Village.

AL-P35 Strive to prevent regional traffic from adversely impacting residential and neighborhood-oriented commercial areas.



Ballard/Interbay Northend Manufacturing & Industrial Center (BINMIC)

ECONOMIC DEVELOPMENT POLICIES

- BI-P1** Accept growth target of at least 3,800 new jobs for the BINMIC by 2014.
- BI-P2** Preserve land in the BINMIC for industrial activities such as manufacturing, warehousing, marine uses, transportation, utilities, construction, and services to businesses.
- BI-P3** Retain existing businesses within the BINMIC and promote their expansion.
- BI-P4** Attract new businesses to the BINMIC.
- BI-P5** Recognize that industrial businesses in the BINMIC have the right to enjoy the lawful and beneficial uses of their property.
- BI-P6** Strive to provide infrastructure in the BINMIC that is sufficient to ensure the efficient operation and smooth flow of goods to, through, and from the BINMIC. Infrastructure includes publicly built and maintained roads, arterials, utilities, moorage facilities, and other capital investments by the City, Port, County, State, and Federal agencies.
- BI-P7** Assist in implementing initiatives recognized and organized by business and property owners and labor organizations to improve economic and employment opportunities in the BINMIC area.
- BI-P8** Maintain the BINMIC as an industrial area and work for ways that subareas within the BINMIC can be better utilized for marine/fishing, high tech, or small manufacturing industrial activities.
- BI-P9** Support efforts to locate and attract appropriately skilled workers, particularly from adjacent neighborhoods, to fill family-wage jobs in the BINMIC.
- BI-P10** Support efforts to provide an educated and skilled labor workforce for BINMIC businesses.
- BI-P11** Within the BINMIC, water-dependent and industrial uses shall be the highest priority use.
- BI-P12** Within BINMIC, support environmental cleanup levels for industrial activity that balance the lawful and beneficial uses of industrial property with environmental protection.

FREIGHT MOBILITY & TRANSPORTATION GOALS

- BI-G1** Strive to improve industrial traffic flow to and through the BINMIC.

BALLARD/INTERBAY/NORTHEND

Manufacturing/Industrial Center

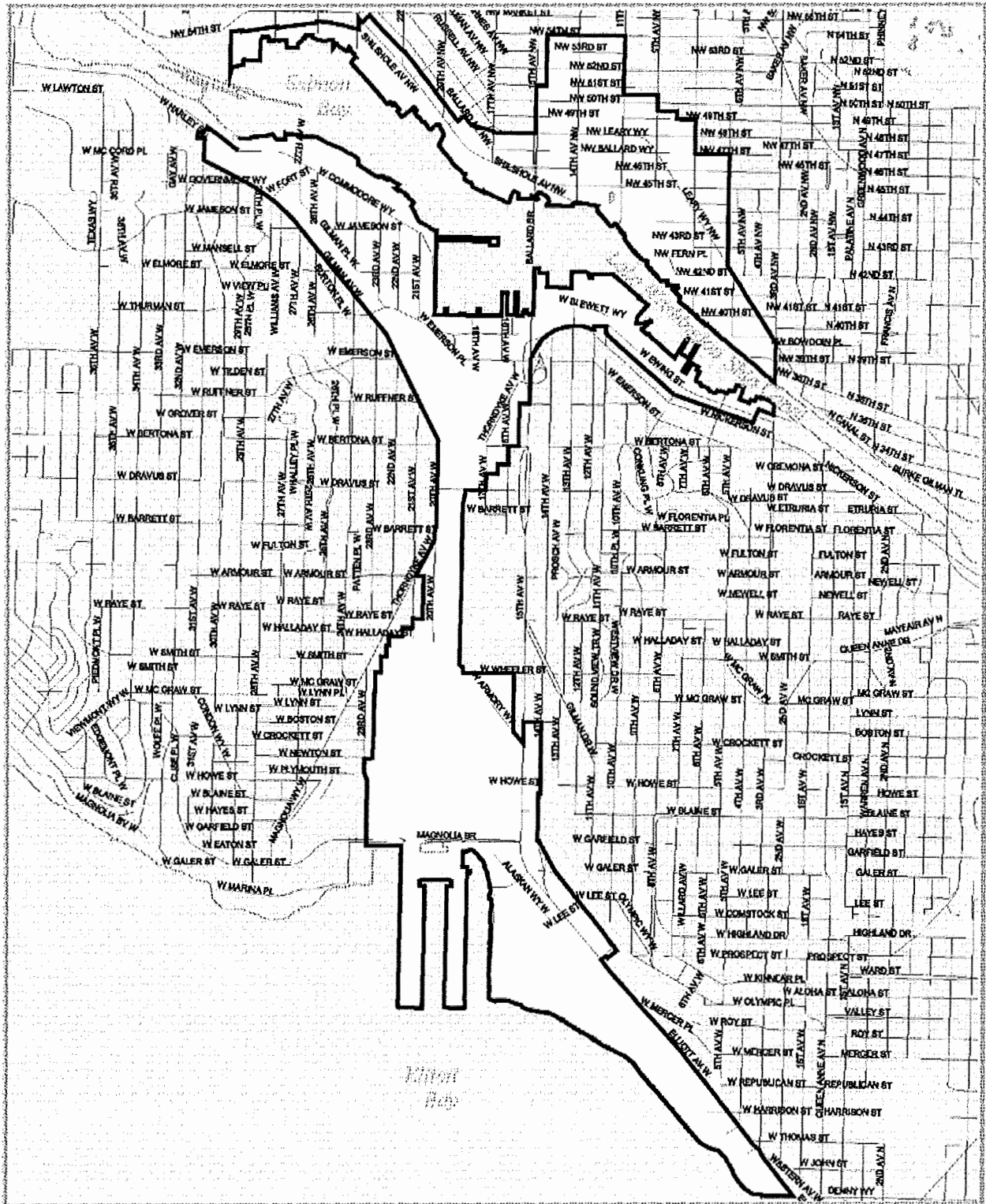

- BI-G2** Facilitate truck mobility.
- BI-G3** Work in conjunction with King County/Metro to promote increased transit to and through the BINMIC, and transit ridership to BINMIC businesses.
- BI-G4** Strive to maintain and enhance intermodal (barge, ship, rail, and truck) connections.
- BI-G5** Strive to maintain and promote rail service to and through the BINMIC.
- BI-G6** Strive to provide adequate room in the street right-of-way for truck loading and maneuvering where it will not interfere with traffic flow.
- BI-G7** Encourage clear directional signage to and from the BINMIC to regional highways.
- BI-G8** Maintain major truck routes to and within the BINMIC in good condition.
- BI-G9** Improve key intersections to and within the BINMIC.
- BI-G10** In order to preserve freight mobility: strive to preserve and improve turning radii, visibility and sight lines, clearance, and existing lane configuration of streets within the BINMIC; and consider impacts on BINMIC of changes to arterial access routes to the BINMIC.
- BI-G11** Support commuting to work to and through the BINMIC by bicycle and walking. Two major factors to consider in trail design and operation are: 1. the operational requirements of adjacent property owners and users, as determined by the City; and 2. the safety of bicycle riders and pedestrians. The City must make every effort in trail design to meet the operational requirements of industrial users while providing for trail safety.

FREIGHT MOBILITY & TRANSPORTATION POLICIES

- BI-P13** Where practical and appropriate, separate mainline rail traffic from surface street traffic by designing and constructing bridges to improve safety for motorized and nonmotorized transportation.
- BI-P14** Support preservation of all streets within the BINMIC and arterial access routes to the BINMIC for freight mobility. To accomplish this, support preservation of turning radii, visibility and sight lines, clearance, and existing lane configurations.
- BI-P15** Support commuting to work by BINMIC employees by bicycle and walking. For safety and operational reasons, however, support locating recreational and commuter through trails away from industrial areas.
- BI-P16** Support separation of mainline rail traffic from surface street traffic by designing and constructing bridges, where feasible, to improve safety for motorized and nonmotorized transportation.

MARITIME & FISHING INDUSTRY POLICIES

- BI-P17** Recognize the interdependence of maritime and fishing industries and related businesses and their special requirements for transportation, utilities, pier space, and chill facilities. Encourage retention of this cluster of businesses and facilitate attraction of related businesses.
- BI-P18** Support maintenance of and creation of pier space for larger vessels (over 60 feet) within the BINMIC to facilitate loading of cargo, provisions, and fuel and obtaining maintenance.
- BI-P19** Support efforts to measure, encourage, and promote the significant role of the maritime and fishing industries.
- BI-P20** Strive to retain shorelines for water-dependent uses by enforcing waterfront and shoreline regulations in industrial areas.
- BI-P21** Strive to provide a physical and regulatory environment that fosters the continued health of the maritime and fishing industries in the BINMIC.
- BI-P22** Encourage land assembly on the BINMIC waterfront to accommodate commercial fishing and other heavier maritime uses.
- BI-P23** Support the Seattle-based distant-water fishing fleet's efforts to participate effectively in Federal and State fisheries management and regulation of fishing.

PUBLIC SERVICES, UTILITIES, & INFRASTRUCTURE POLICIES

- BI-P24** Public services, utilities, and infrastructure shall be sufficient to accommodate projected growth.
- BI-P25** Strive to provide opportunities for industrial reuse of vacant governmentally owned property within the BINMIC.
- BI-P26** Provide excellent customer service in City departments for industrial businesses.
- BI-P27** Strive to develop creative financing mechanisms, including public-private partnerships, for upgrading utilities and infrastructure.
- BI-P28** Develop linkages between local businesses, labor groups, and workers to match high-wage jobs with local workers.

Broadview/Bitter Lake/Haller Lake

PUBLIC INVOLVEMENT GOAL

- BL-G1** A community where residents, businesses, community organizations, and property owners are involved throughout the implementation of the neighborhood plan.

UTILITIES GOAL

BL-G2 Environmentally sound sanitary sewer, storm water, and drinking water systems throughout the Broadview, Bitter Lake, and Haller Lake neighborhoods are well-maintained and adequate to serve the current and future population.

UTILITIES POLICIES

BL-P1 Integrate the area's formal and informal drainage and storm water systems with the appropriate basin or citywide system.

BL-P2 Use environmentally sensitive solutions to resolve drainage and wastewater challenges, such as by encouraging groundwater infiltration where paved surfaces predominate.

BL-P3 Create system-wide drainage infrastructure that enables the construction of "complete streets" along arterials, while also linking individual green stormwater infrastructure improvements.

BL-P4 Design sustainable drainage solutions that provide for adequate sidewalks on both sides of streets and planned bicycle facilities.

BL-P5 Plan, provide, and maintain adequate utility services in collaboration with the community.

TRANSPORTATION GOALS

BL-G3 A community where neighbors are able to comfortably walk and bicycle from residential areas to Aurora Avenue, other area business districts, schools, parks, churches, community facilities, and other neighborhood focal points via a connected network of sidewalks, pathways, and bicycle facilities.

BL-G4 An attractive and functional streetscape on Aurora Avenue that includes safe sidewalks and crossings, facilities encouraging reliable transit, freight mobility, safe auto access, landscaping, and drainage.

BL-G5 Develop a comprehensive and safe network of "complete streets" (multimodal) that supports access and mobility for residents and business customers and employees.

BL-G6 Efficient vehicular movement through north-south and east-west transportation corridors.

BL-G7 A neighborhood in which regional traffic does not have a serious impact on local streets.

BL-G8 Transit systems that provide convenient and fast local and regional transportation, connecting the urban village and surrounding residential areas to the rest of the city and region.

BL-G9 Aurora Avenue is designed to serve the communities and development along it as well as local and regional transportation needs.

BITTER LAKE VILLAGE

Hub Urban Village

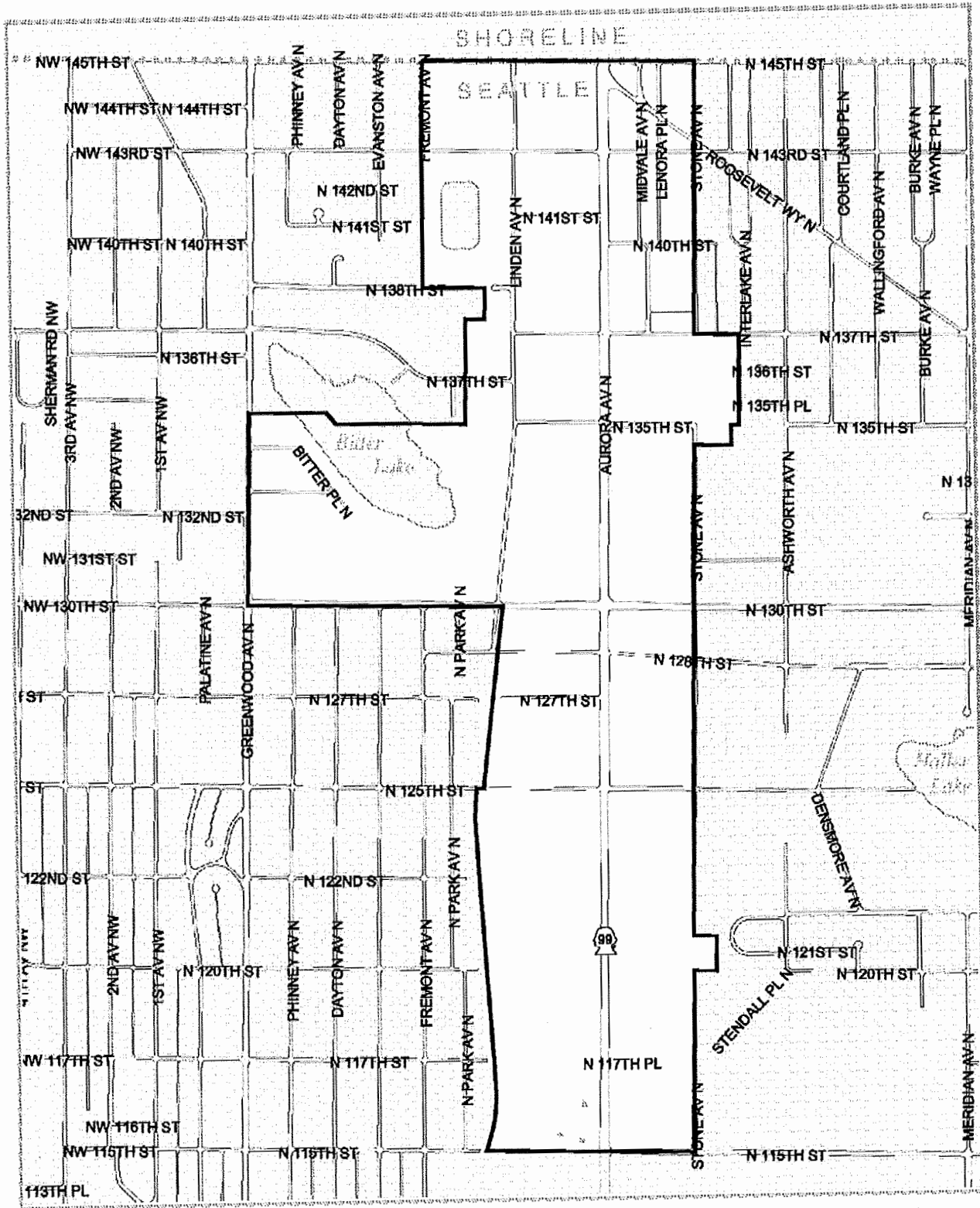

VILLAGE BOUNDARY
 EDGE OF PAVEMENT



BL-G10 Aurora Avenue will be a high-capacity transit (e.g. bus rapid transit) corridor.

TRANSPORTATION POLICIES

- BL-P6** Involve local community organizations, schools, property and business owners, residents, and other interested parties in the design of safe and efficient auto, bus, freight, bike, and pedestrian access in neighborhoods and to local businesses, schools, and other public facilities.
- BL-P7** Develop funding sources to design, construct, and maintain a network of “complete streets” that provide accessible pedestrian walkways, including sidewalks along arterial streets.
- BL-P8** Develop funding sources to design, construct and maintain pedestrian pathways that will link residents to the “complete streets” network and other community focal points, including schools and transit stops.
- BL-P9** Work with the State, King County Metro, and the community to fund the design and construction of Aurora Avenue improvements to provide sidewalks and pedestrian crossings, frequent and fast transit, and adequate drainage.
- BL-P10** Develop funding sources for the design and construction of the network of bicycle facilities recommended in the Bicycle Master Plan that will connect Broadview, Bitter Lake, and Haller Lake residential neighborhoods with community destinations as well as regional trails and other nearby urban villages.
- BL-P11** Use design and traffic circulation strategies that keep residential streets free from excessive traffic volumes and speed.
- BL-P12** Improve the capacity of Aurora Avenue to support access by transit, pedestrians, bicycles, and automobiles, while maintaining freight mobility.
- BL-P13** Design future circulation improvements along other arterials in the area to balance vehicular, pedestrian and bicycle circulation.
- BL-P14** Encourage future vehicular circulation improvements along other arterials in the area that balance pedestrian and bicycle circulation.
- BL-P15** Work with transit providers to provide safe, accessible, and convenient transit stops.

LAND USE & HOUSING GOALS

- BL-G11** A community where new development is environmentally friendly, supports pedestrians, contains a wide range of housing types and income levels and accommodates businesses offering a diverse selection of products and services.
- BL-G12** A hierarchy of vibrant commercial centers: regional (Aurora Avenue); urban village (Linden Avenue); and neighborhood (Greenwood Avenue nodes).

- BL-G13** Create a vibrant mixed-use “town center” along Linden Avenue that supports a greater range of neighborhood-serving shops and services, and high-quality dense residential housing serving a wide range of income levels.

LAND USE & HOUSING POLICIES

- BL-P16** Plan for Broadview/Bitter Lake/Haller Lake’s growing age, household, and ethnic diversity so that a range of affordable housing types are made available to a variety of residents including individuals, couples, and families of varying ages within the urban village.
- BL-P17** Plan and design commercial developments, parks and schools to be walkable places using such methods as interior sidewalks linking building entrances to each other and to adjacent sidewalks, pedestrian-scale lighting, limiting the size of buildings to create block-sized patterns of development, and orienting development toward public streets.
- BL-P18** Strengthen Aurora Avenue as a regional commercial center and source of jobs, while enhancing its fit with surrounding communities.
- BL-P19** Use economic development strategies to organize, attract and assist neighborhood-serving businesses to Broadview/Bitter Lake/Haller Lake.
- BL-P20** Support business and residential growth in the Greenwood Avenue business nodes at North 125th and between North 143rd and North 145th to enhance the vitality of these smaller neighborhood centers.
- BL-P21** Take steps toward developing Stone Avenue North into a green corridor, planted with trees and landscaping, to provide a transition between commercial uses and the Haller Lake residential area.
- BL-P22** Preserve existing open space and study the creation of new open space throughout the planning area. Seek additional opportunities to plant trees throughout the community.
- BL-P23** Use the permitting and environmental review process to minimize or mitigate the impacts of commercial and higher density residential uses on nearby single-family residential areas.
- BL-P24** Encourage design and site planning of single-family and multifamily housing that fits with the surrounding neighborhoods.
- BL-P25** Develop and use neighborhood design guidelines to help establish an urban design vision for Linden Avenue, to guide multifamily and commercial development that enhances the pedestrian environment, and to ensure appropriate transitions between single-family neighborhoods and denser commercial areas.
- BL-P26** Develop regulations, incentives, and educational materials to minimize lot clearing and ensure creative site designs that retain mature trees.

RECREATION GOAL

BL-G14 A community where a system of safe and well-maintained pocket parks, playgrounds, gardens, public plazas, and larger parks take advantage of natural amenities such as lakes, creeks, and the shores of Puget Sound.

RECREATION POLICIES

- BL-P27** Reinforce and expand parks and open spaces through partnerships and other strategic efforts.
- BL-P28** Coordinate future capital improvements so that Linden Avenue North becomes a greener corridor with a neighborhood “village center” focal point and opportunities for recreation.
- BL-P29** Enhance the “neighborhood feel” of Linden Avenue North area by creating more gathering places for community members to meet.
- BL-P30** Increase public access to public water bodies.
- BL-P31** Include the Seattle school district, community organizations, property owners, residents, and parents of schoolchildren in planning to provide attractive public facilities in the Broadview, Bitter Lake, and Haller Lake neighborhoods.
- BL-P32** Continue to offer excellent public services at neighborhood City facilities.

PUBLIC SAFETY GOAL

BL-G15 A community where residents feel safe and the community works with safety officers to reduce crime.

PUBLIC SAFETY POLICIES

- BL-P33** Increase the visibility of law enforcement efforts and maintain an adequate presence of officers within the city and community.
- BL-P34** Include community organizations, property and business owners, residents, and other interested parties in identifying high crime areas and targeting appropriate City and community resources.
- BL-P35** Provide community safety programs, such as block watch and emergency preparedness, and implement additional crime prevention measures, such as increased lighting of public spaces.

NATURAL ENVIRONMENT GOAL

BL-G16 A community where government agencies, community and environmental organizations, property and business owners, residents, and other interested parties

work together to preserve, restore, and enhance our area's natural resources, including our lakes, creeks, and watersheds, and protect habitat for fish, birds, and other wildlife.

NATURAL ENVIRONMENT POLICIES

- BL-P36** Use the design process and environmental review to identify ways to mitigate environmental impacts resulting from activities at City facilities, as appropriate.
- BL-P37** Create a greener and healthier environment by protecting existing trees, as appropriate, and planting new trees.
- BL-P38** Include the community, property owners and other public agencies in identifying tools to improve air and water quality, reduce noise pollution, and remediate environmental impacts of current and past activities, as appropriate.

COMMUNITY DEVELOPMENT GOAL

- BL-G17** Support a resilient community rich in different ages, incomes, and household types.

COMMUNITY DEVELOPMENT POLICIES

- BL-P39** Create a unified name and identity for the Broadview/Bitter Lake/Haller Lake area, reflecting its history, to nurture neighborhood pride and motivate various groups to come together as one community.
- BL-P40** Create more opportunities for people to come together where they can meet and get to know their immediate (within a block or so) neighbors.

URBAN AGRICULTURE GOALS

- BL-G18** Stores, restaurant, and schools that provide healthy food choices.
- BL-G19** An abundant local food economy that draws from urban agriculture activity in the neighborhood as well as regional food sources.

URBAN AGRICULTURE POLICIES

- BL-P41** Expand access to locally grown food, by attracting farmers' markets and a wider range of grocery stores.
- BL-P42** Create opportunities for the community to learn how to establish and maintain urban agriculture practices in the neighborhood through projects such as P-Patches and community gardens, as well as on private property.

Capitol Hill

COMMUNITY CHARACTER GOAL

- CH-G1** A neighborhood, with distinct residential areas, active business districts, accessible transportation services, and strong institutions, which is diverse and densely populated.

COMMUNITY CHARACTER POLICIES

- CH-P1** Encourage the development of the North Anchor District as Capitol Hill's premier art, culture, civic, and business hub with a centerpiece being a new mixed-use civic and residential complex at the Keystone site located at the north end of Broadway at 10th Avenue and Roy Street. If the Library Board selects the Keystone site as the new location for the Susan Henry Library, take actions to facilitate the location of the library, including, if appropriate, rezoning.
- CH-P2** Encourage the revitalization of the South Anchor District through coordination of the development of a Sound Transit station, the Lincoln Reservoir Park project, and a revised master plan for Seattle Central Community College.
- CH-P3** Support and preserve the neighborhood's three main commercial corridors—Broadway, 15th Avenue East, and East Olive Way.
- CH-P4** Strengthen and enhance the character of the major residential neighborhoods and encourage a greater range of housing choices affordable to a broad spectrum of the entire community.

LAND USE & URBAN DESIGN GOAL

- CH-G2** An enhanced neighborhood with diverse land uses, a mixture of housing types including single-family and dense multifamily, and vibrant commercial districts.

LAND USE & URBAN DESIGN POLICIES

- CH-P5** Encourage the preservation of the neighborhood's architectural quality, historic character, and pedestrian scale.
- CH-P6** Support integration of transit-oriented development with local transportation and open space improvements.
- CH-P7** Strive to enhance the neighborhood's lively, unique pedestrian-oriented commercial corridors.
- CH-P8** Enhance and protect the character of the diverse residential districts.

CAPITOL HILL
Part of the First Hill/Capitol Hill Urban Center

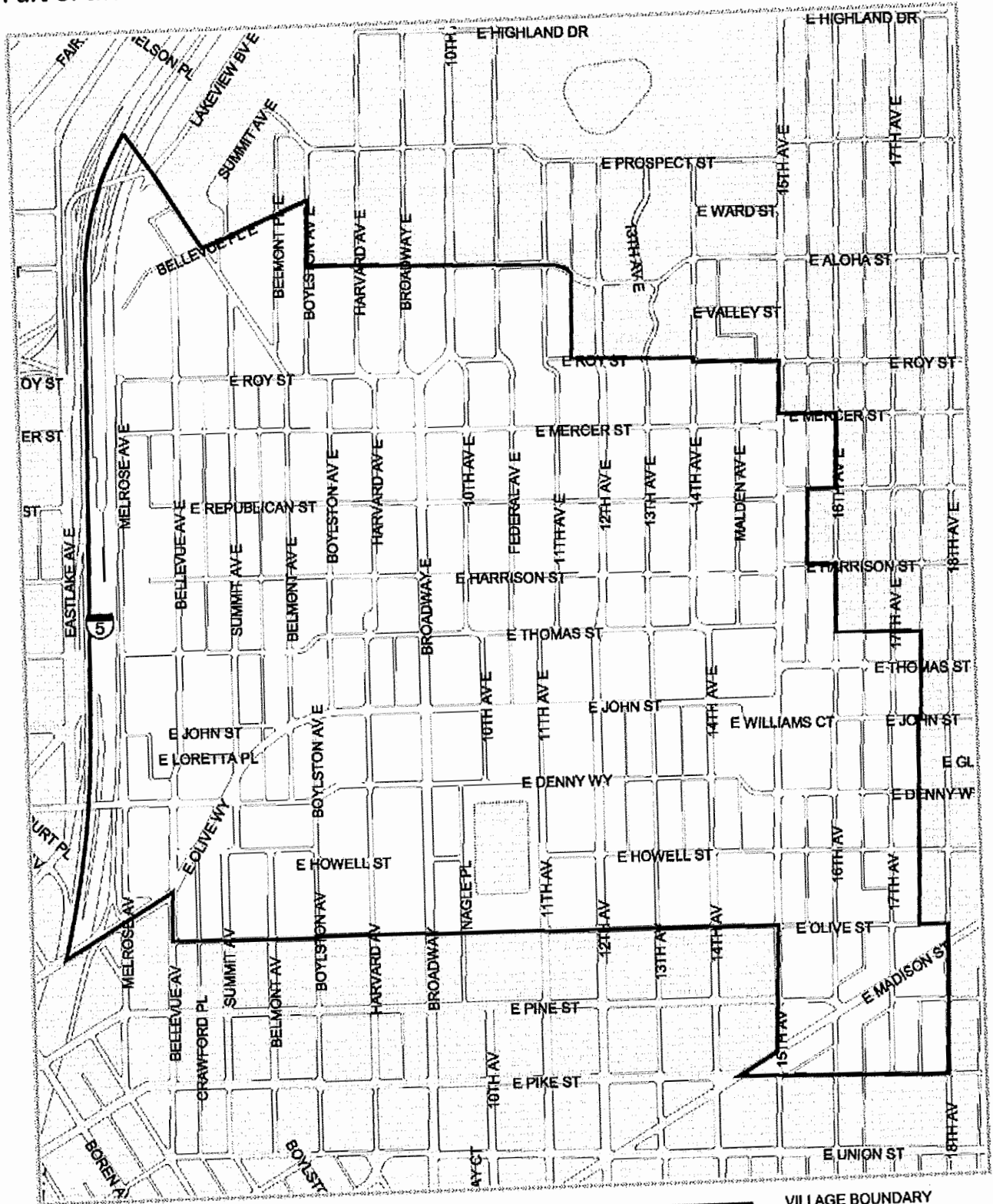

VILLAGE BOUNDARY
EDGE OF PAVEMENT

- CH-P9** Zoning and design guidelines should ensure that new development complements the existing architectural fabric of the neighborhood.
- CH-P10** Support and encourage the relocation of the Susan Henry Library through zoning and other tools that would be appropriate.

HOUSING GOAL

- CH-G3** A community with a full range of housing types from single-family homes to multifamily contributing to a diverse, densely populated neighborhood.

HOUSING POLICIES

- CH-P11** Seek tools to retain and increase housing affordable to households with incomes at and below the median income.
- CH-P12** Strive to preserve and provide a variety of housing types, including some single-family and other small-scale dwellings.
- CH-P13** Encourage a range of homeownership options for households with a broad spectrum of incomes.
- CH-P14** Encourage the preservation of existing housing structures and the maintenance of properties.
- CH-P15** Encourage the development of high-quality new housing that blends with historic housing.

HUMAN DEVELOPMENT GOAL

- CH-G4** A neighborhood that recognizes and meets the diverse and distinctly different human service needs of a culturally and economically diverse population.

HUMAN DEVELOPMENT POLICIES

- CH-P16** Promote community connections and cohesion by encouraging opportunities for people to come together, interact, support, and get to know each other and participate in a range of activities.
- CH-P17** Seek to improve communication between people, organizations, and communities dealing with human needs and human development issues.
- CH-P18** Seek a comprehensive approach to address social issues and human needs within the neighborhood.

PUBLIC SPACE & ARTS GOAL

- CH-G5** A neighborhood that provides amenities (quality parks/open space/arts) to serve its dense population.

PUBLIC SPACE & ARTS POLICIES

- CH-P19** Seek opportunities for the development of new parks and open spaces to adequately serve all Capitol Hill residents, including children, youth, and seniors.
- CH-P20** Encourage the development of open spaces complementary to commercial corridors and Sound Transit stations.
- CH-P21** Strive to maintain and enhance environmental quality in the neighborhood's public spaces.
- CH-P22** Promote safety and a civil environment in the neighborhood's public spaces.
- CH-P23** Support arts and cultural activities as an integral part of community life.
- CH-P24** Support neighborhood cultural institutions, including the Cornish College of the Arts, the Susan Henry Library, and Seattle Central Community College.

TRANSPORTATION GOAL

- CH-G6** A pedestrian-oriented neighborhood with a balanced transportation environment that emphasizes public transit, yet also facilitates vehicular mobility and addresses the parking needs of businesses, residents, and students.

TRANSPORTATION POLICIES

- CH-P25** Support construction of light rail transit services through Capitol Hill with transit stations.
- CH-P26** Support a variety of transportation modes that provide alternatives to using a car.
- CH-P27** Encourage traffic-calming measures in residential neighborhoods.
- CH-P28** Discourage commuter and employee parking in the neighborhood.
- CH-P29** Strive to improve parking management to better serve the needs of businesses and residents.
- CH-P30** Work with transit providers to improve transit service and speed within the neighborhood and connections to other neighborhoods.

Central Area

OVERALL CENTRAL AREA COMMUNITY IDENTITY & CHARACTER AND LAND USE GOALS

- CA-G1** The Central Area is a community proud of its culture, heritage, and diversity of people and places. This richness derives from the fact that this neighborhood has always been a place of welcome and it has been, and continues to be the center of the African American community.
- CA-G2** The Central Area is a community that provides inclusive opportunities for everyone to participate in community projects.

OVERALL CENTRAL AREA COMMUNITY IDENTITY & CHARACTER AND LAND USE POLICIES

- CA-P1** Strengthen a unique identity for the Central Area that celebrates its culture, heritage, and diversity; enhance the sense of community; and increase the feeling of pride among Central Area residents, business owners, employees, and visitors through excellent physical and social environments.
- CA-P2** Recognize the historical importance and significance of the Central Area's existing housing stock, institutional buildings (old schools, etc.), and commercial structures as community resources. Incorporate their elements into building design and possible designation of historic and cultural resources.
- CA-P3** Seek opportunities for community-based public improvements that would create a sense of identity, establish pride of place, and enhance the overall image of the Central Area.
- CA-P4** Create opportunities for public spaces, public art, and gateways that engage and express the Central Area's unique heritage and identity.
- CA-P5** Identify activities and spaces for people with diverse cultures, ages, and background to meet, share, learn, and strengthen community ties.
- CA-P6** Create an appealing environment that enhances the historic character while providing opportunities for existing and new development to grow, and serve the emerging needs of the diverse community.
- CA-P7** Create a vibrant commercial district, encouraging dense urban development in the commercial areas and encouraging housing supportive of the community through land use tools, such as rezones, design guidelines, and incentives.
- CA-P8** Support existing and new Central Area community programs and expand on existing partnerships so these programs prioritize services to those who consider the Central Area to be central to their identity, such as the African American community .



- CA-P9** Support a network of community-based organizations that can coordinate diverse volunteers to implement community building programs and projects that serve to anchor the cultural diversity of the Central Area.

TRANSPORTATION & INFRASTRUCTURE GOALS

- CA-G3** A community where residents, workers, students, and visitors can choose from a variety of comfortable and convenient modes of transportation including walking, bicycling, and transit and where our reliance on cars for basic transportation needs is minimized or eliminated.
- CA-G4** The neighborhood has an efficient and effective network of transit including linkages to the proposed East Link light rail station that supports land use goals and adequately serves the community.
- CA-G5** A community that is served by well-maintained infrastructure including the most up to date communication technology such as fiber optic telecommunication infrastructure.

TRANSPORTATION & INFRASTRUCTURE POLICIES

- CA-P10** Facilitate movement of residents, workers, visitors, and goods within the Central Area with a particular focus on increasing safety.
- CA-P11** Support a multimodal transportation network that connects community destinations such as economic centers, schools, recreational facilities, shopping nodes, and social gathering places and that links the Central Area to other neighborhoods.
- CA-P12** Consider traffic-calming measures on Central Area arterial streets.
- CA-P13** Work with institutions/businesses to develop creative solutions for minimizing single-occupant auto usage by employees and students.
- CA-P14** Maintain and improve pedestrian infrastructure including sidewalks, stairways, pedestrian underpasses, and planting strips and medians on arterial streets to enhance pedestrian safety, mobility, and access.
- CA-P15** Consider improvements to unimproved rights-of-way such as street ends or alleys to foster pedestrian access and mobility.
- CA-P16** Coordinate transportation and infrastructure project planning with adjacent neighborhoods if they are affected by these projects.
- CA-P17** Facilitate convenient transit access to local and regional employment centers for Central Area residents.
- CA-P18** Encourage shared parking at business nodes in order to meet parking demand while minimizing the size of surface parking lots and maximizing space for other uses.

- CA-P19** Encourage coordination of construction work within the street right-of-way in order to maximize the public benefit and minimize the disruption of the street surface.
- CA-P20** Improve road safety through public education, targeted enforcement, and engineering measures.
- CA-P21** Develop a multimodal access plan for proposed and future high-capacity transit stations (Bus Rapid Transit, light rail) that serve or are near to the Central Area.
- CA-P22** Create safe pedestrian and bicycle access to bus and light rail service and to the business districts.
- CA-P23** Encourage King County Metro to provide effective bus service through the neighborhood to the light rail stations and surrounding community facilities.
- CA-P24** Improve the visual quality of the neighborhoods by encouraging undergrounding of utilities including service lines for all new construction and remodel projects and minimizing the impact of new telecommunication facilities such as towers.

HOUSING GOAL

- CA-G6** The Central Area is a stable community that provides a range of housing types and affordable options to support the sociodemographic diversity of this neighborhood.

HOUSING POLICIES

- CA-P25** Advocate for more flexible options for mortgage financing, and strive to remove barriers to homeownership and renovation loans for local residents.
- CA-P26** Support sweat-equity housing programs.
- CA-P27** Support housing services that encourage age integration.
- CA-P28** Ameliorate the potential impacts of gentrification and displacement of existing residents through a variety of affordable housing programs including preserving existing multifamily affordable housing and producing new affordable housing.
- CA-P29** Maintain and create affordable housing to keep a range of housing prices and unit sizes including affordable family-sized units with amenities for families, and a balance of rental and owner-occupied housing.
- CA-P30** Assist low-income, senior, and disabled renters and homeowners by encouraging supportive services that will allow them to continue to live in the neighborhood.
- CA-P31** Encourage affordable housing in close proximity or with easy access to community assets and amenities.
- CA-P32** Target affordable housing investments near investments in high-frequency transit to reduce the transportation costs of low-income households.
- CA-P33** Leverage publicly owned properties to produce affordable housing.

- CA-P34** Provide development incentives to multifamily housing developers for provision of affordable housing units within market-rate housing projects.

ECONOMIC DEVELOPMENT GOALS

- CA-G7** The Central Area is a culturally and ethnically diverse and economically strong community. Its business districts provide the goods and services needed for the multicultural community who live, work, worship, and shop there.
- CA-G8** The Central Area has vibrant commercial districts with diverse economic opportunities for area residents, including career-path family-wage jobs for its residents.
- CA-G9** The Central Area has strong entrepreneurship that creates jobs and grows the local economy for the benefit of its residents.
- CA-G10** This neighborhood is, and feels, safe and inviting for people and businesses.

ECONOMIC DEVELOPMENT POLICIES

- CA-P35** Support efforts to encourage existing and new minority and locally owned businesses in the Central Area to grow and expand.
- CA-P36** Support implementation of coordinated long-term strategies to improve commercial districts including support for existing or expanding small businesses and ethnically based businesses in order to maintain the multicultural character.
- CA-P37** Support strong, culturally inclusive business associations that support the vitality of business districts serving the entire community.
- CA-P38** Support vibrant, diverse, and distinct commercial districts that provide a range of goods and services for the entire community.
- CA-P39** Support projects that increase affordable, culturally appropriate and healthy food.
- CA-P40** Create strong linkages to tie job and vocational training, apprenticeship programs, and jobs to members of the community in need of such services, especially youth.
- CA-P41** Build strong partnerships and support projects that provide opportunities for local jobs for Central Area residents and pathways to living wage jobs in the region's employment centers.
- CA-P42** Strive to develop healthy workplaces where employees are treated with respect, and have a voice in decisions that impact their jobs, lives, and community.
- CA-P43** Provide opportunities and support to facilitate start-up small businesses.
- CA-P44** Encourage partnerships among businesses to create a safe and active commercial district.

- CA-P45 Seek opportunities to strengthen partnerships between the community and the Seattle Police Department.
- CA-P46 Support crime prevention programs that create partnerships between the broad diversity of the community, the businesses, and the City to decrease crime and to address underlying conditions that may encourage crime.
- CA-P47 Support efforts to improve the appearance and cleanliness of business districts.

HUMAN SERVICE AND COMMUNITY BUILDING GOALS

- CA-G11 The Central Area is a connected and caring community that nurtures and supports all its members especially the children, youth, and the elderly, and provides programs and services needed by its diverse community.
- CA-G12 The Central Area has strong schools with excellent programs and strong enrollment with no achievement gap, providing opportunities for all students to succeed and have bright futures.
- CA-G13 The Central Area is a neighborhood in which the community, community-based organizations, service organizations, education/training institutions, and the City work together to create pathways to meaningful employment for all its youth.
- CA-G14 To support cultural diversity, there is improved access to education and employment training opportunities for all, especially for its diverse youth.
- CA-G15 All Central Area youth are empowered and have strong leadership skills.
- CA-G16 The Central Area has strong organizations and local leaders who work to anchor the cultural diversity of this neighborhood.

HUMAN SERVICE AND COMMUNITY BUILDING POLICIES

- CA-P48 Encourage local institutions, community-based organizations, and other agencies to provide lifelong learning opportunities needed by the Central Area's diverse community.
- CA-P49 Provide all Central Area youth with required skills and experience needed for future careers. Maximize the capability of local institutions and program providers such as Seattle Vocational Institute to serve such needs.
- CA-P50 In the Central Area, support the growth of jobs for teenagers, especially those most in need of a path to a successful future.
- CA-P51 Provide the Central Area youth with cultural education and recreational opportunities that embrace its diversity.
- CA-P52 Enhance community pride through multicultural activities such as community festivals, youth mentoring, and other youth programs.
- CA-P53 Support innovative and effective youth services.



- CA-P54** Encourage Central Area youth to actively engage in community activities and develop leadership skills, especially those most in need of such support.
- CA-P55** Provide seniors with needed resources and assistance and opportunities to engage with the community.
- CA-P56** Provide supportive services for the immigrant/refugee and African American communities.
- CA-P57** Support programs and organizations that nurture local leadership within the Central Area.

PARKS AND OPEN SPACE GOAL

- CA-G17** A community with functional, well-maintained and connected parks, open space, and recreational facilities to serve the Central Area's diverse population.

PARKS AND OPEN SPACE POLICIES

- CA-P58** Facilitate community involvement such that park facilities, improvements, and programming better reflect the needs of the neighborhood.
- CA-P59** Seek opportunities within the commercial districts to create open spaces for community gathering.
- CA-P60** Seek opportunities for public open space on unused or unimproved properties.
- CA-P61** Promote greening and beautification of the neighborhood through local citizen participation.
- CA-P62** Work with community members, organizations, schools, and institutions to provide park stewardship.

23RD AVENUE CORRIDOR GOALS

- CA-G18** The three community nodes along 23rd Avenue at Jackson, Union, and Cherry are each distinct with a different niche, but together they exhibit or demonstrate the shared identity of the Central Area. These community nodes together serve the diversity of cultures in the Central Area and continue to be home to those businesses and institutions that are central to the African American community:
- **23rd and Jackson**—The largest of the three community nodes with larger scaled mixed-use developments. It is the community's center for general goods and services including education, arts, places of worship and gathering, parks, a library, housing, social services, and places to shop for daily household needs. It is a local and regional destination that draws a broad mix of people.

**23RD & UNION-JACKSON
Residential Urban Village**

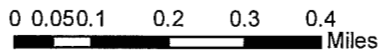
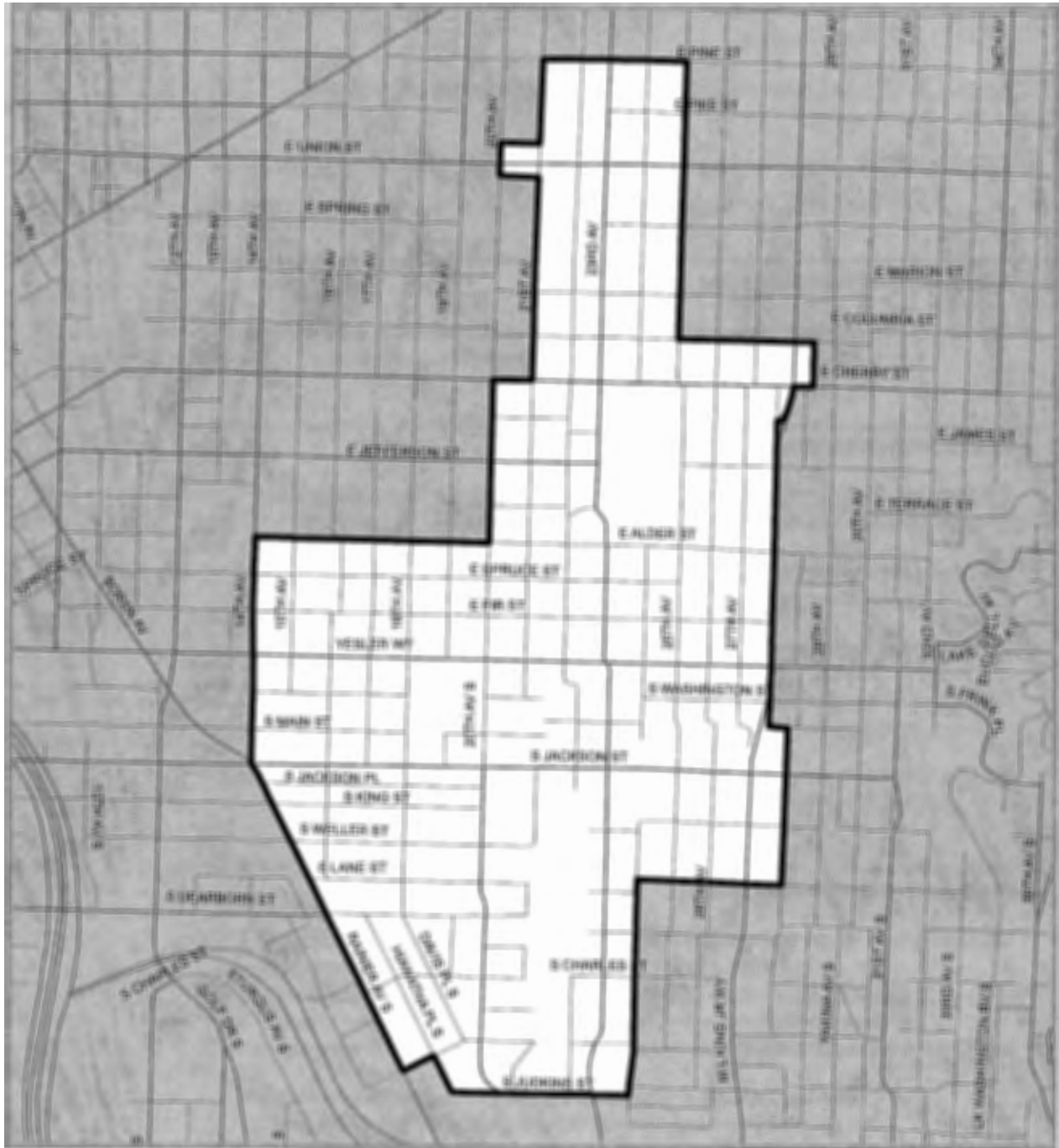

———— CENTER / VILLAGE BOUNDARY



- **23rd and Union**—A medium-sized community-serving node with mixed-use developments. This node has locally owned businesses and institutions and continues to serve as the center of the African American community. It is a neighborhood-scale destination that builds on existing assets and draws customers from the larger neighborhood.
- **23rd and Cherry**—This is a smaller-scaled community-serving node with finer grained mixed-use developments. This node has an abundance of community assets including parks/open space, Garfield High School and Community Center, teen center, arts programs, and small businesses, in particular ethnic restaurants, that create a unique identity for this node. It draws a broad mix of people, especially youth.

23RD AVENUE CORRIDOR POLICIES

- CA-P63** Encourage new pedestrian-friendly mixed-use development and increased housing density in and around the 23rd Avenue and Jackson Street commercial area. Include small and large businesses, opportunities for startup businesses, and affordable housing while preserving existing gathering spaces.
- CA-P64** Support additional retail, restaurants, services, and office space at 23rd and Yesler to increase activity on the sidewalks.
- CA-P65** Encourage new pedestrian-friendly mixed-use development at 23rd and Union that includes neighborhood serving shops and services, opportunities for startup businesses, affordable housing, and live-work housing while respecting the small scale and historic character of this node.
- CA-P66** Preserve small-scale neighborhood character, immigrant- and refugee-owned businesses while providing a greater variety of shops and services at 23rd and Cherry and an activated street frontage.
- CA-P67** Improve access and connectivity to community assets at 23rd and Cherry and activate space around Garfield High School, Garfield Community Center, and Medgar Evers Pool.
- CA-P68** Consider rezoning single-family zoned parcels to neighborhood commercial to support continuation and expansion of services provided by local institutions as the Cherry Hill Baptist Church.

MADISON-MILLER GOALS

- CA-G19** A vibrant, revitalized pedestrian-oriented commercial district on East Madison from 16th to 24th Avenues that serves both local and destination shoppers with a variety of shops and services.
- CA-G20** A vibrant, revitalized pedestrian-oriented commercial node at Madison Street between 19th Avenue and 23rd Avenue that principally serves local residents.

MADISON-MILLER Residential Urban Village

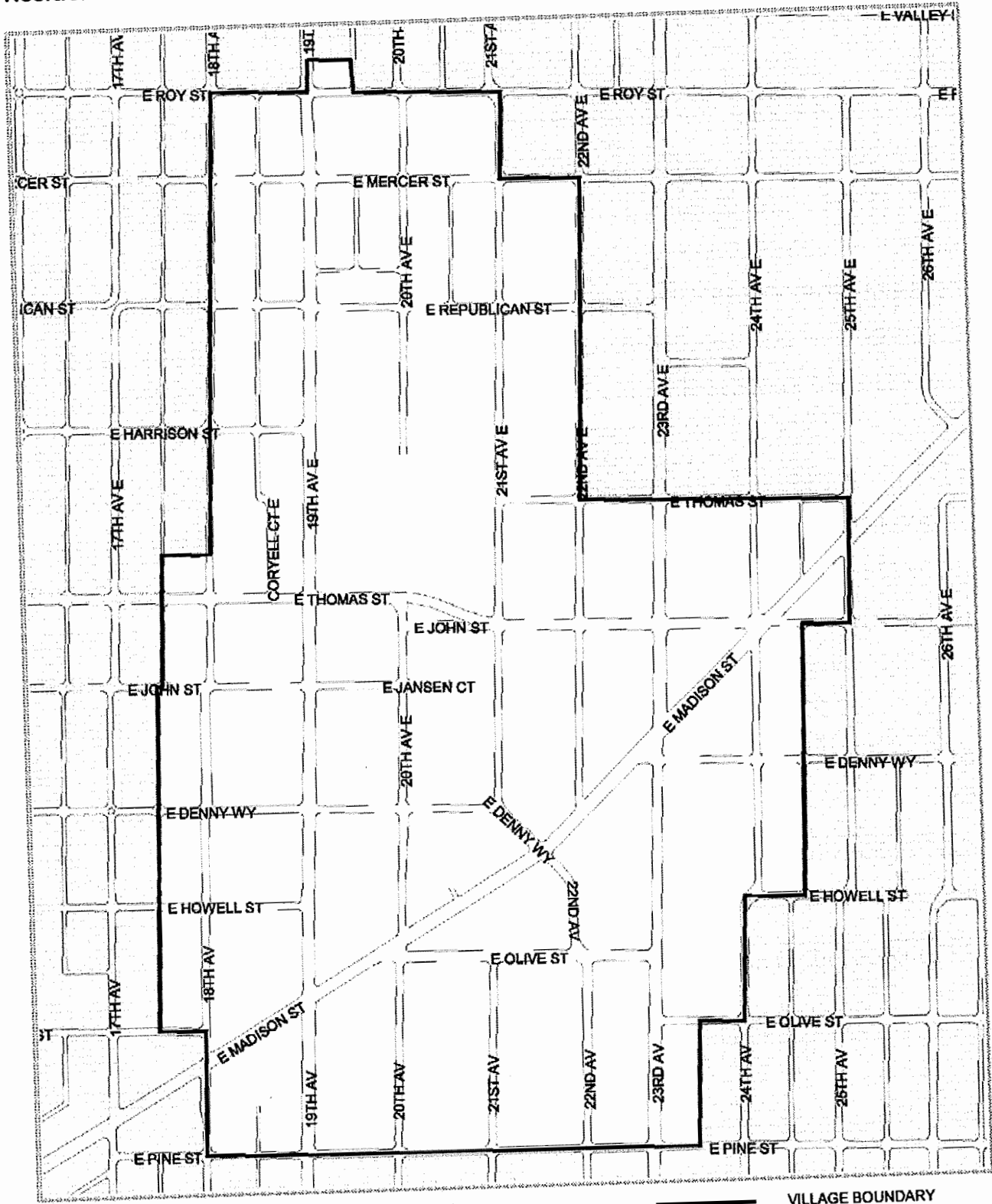

0 500 1000 Feet

VILLAGE BOUNDARY
EDGE OF PAVEMENT

CA-G21 A destination/entertainment center at 23rd and Madison serving as the Central Area's northern commercial anchor.

MADISON-MILLER POLICIES

CA-P69 Encourage increased housing density at 23rd and Madison. As one tool for implementing this policy, consider the Residential Small Lot zone to be appropriate for single-family areas south of East Madison Street within the Madison-Miller Residential Urban Village.

- A. The portion of East Madison Street within the Madison-Miller Residential Urban Village is designated a principal commercial street.

CA-P70 Seek entertainment facilities (e.g., entertainment complex), destination retail, convention and conference facilities, and other like businesses at 23rd and Madison.

CA-P71 Adopt themes and identity elements for Madison-Miller and incorporate into streetscape concepts, transportation improvements, community-based projects, and new development proposals, including concepts such as:

- The area's African American heritage;
- "Madison After Dark";
- Community diversity;
- The physical and natural environment; and
- The area's transportation history.

CA-P72 Explore the potential for an incentive-based East Madison "economic opportunity area."

12TH AVENUE GOAL

CA-G22 A thriving mixed-use residential and commercial area with a "main street" including services and retail that is attractive and useful to neighborhood residents and students, and public spaces that foster a sense of community, near the intersection of several diverse neighborhoods and major economic and institutional centers.

12TH AVENUE POLICIES

CA-P73 Encourage increased housing density where appropriate, such as on 12th Avenue and on Yesler Way, and in midrise zoned areas.

CA-P74 Facilitate the redevelopment of City-owned land, emphasizing mixed-use where that type of development will contribute to the desired community character.

CA-P75 Seek services and retail that build on the neighborhood's proximity to Seattle University.



12TH AVENUE
Part of the First Hill/Capitol Hill Urban Center

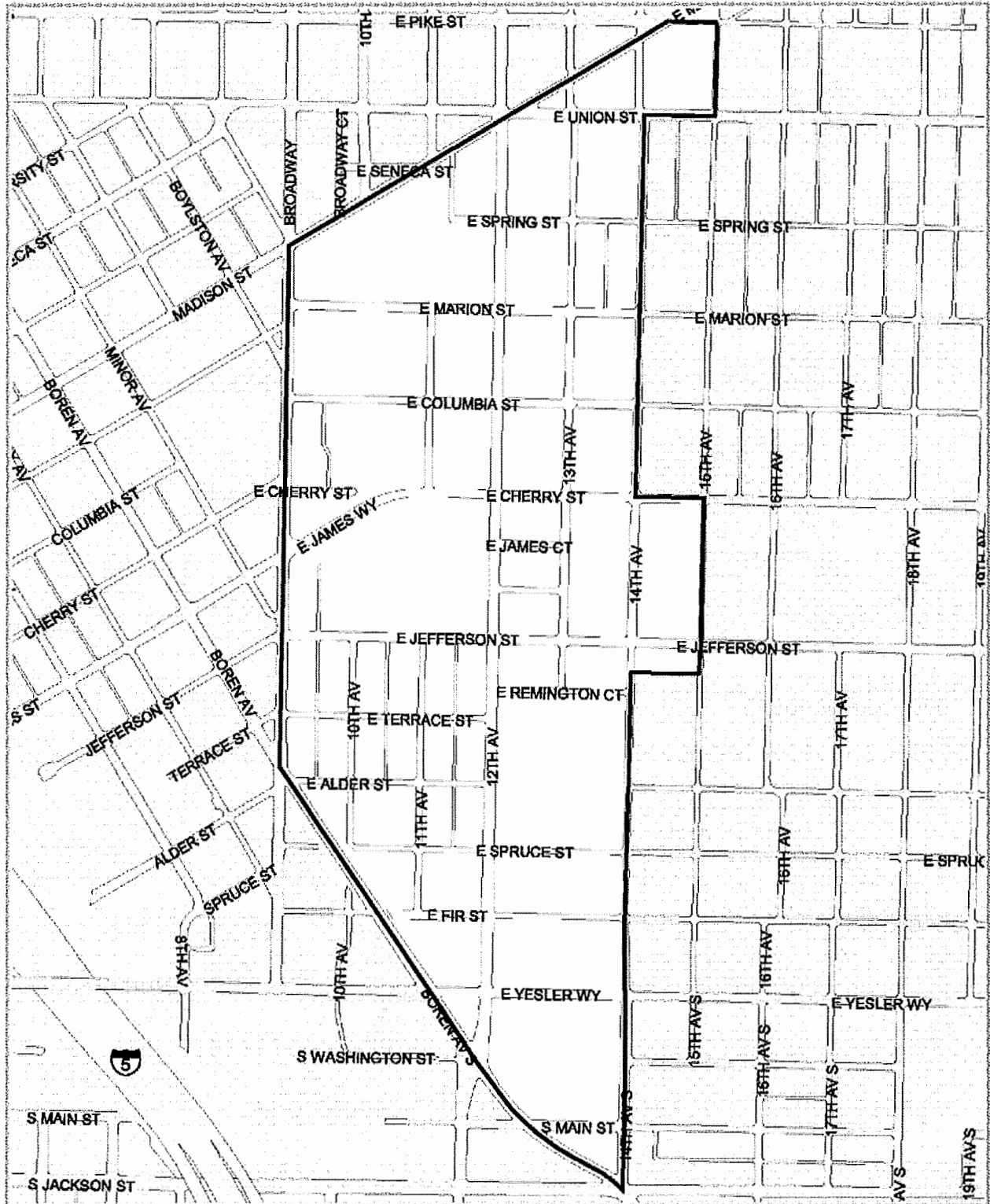

— VILLAGE BOUNDARY
- - - EDGE OF PAVEMENT



Columbia City

TRANSPORTATION GOALS

- CC-G1** A community with a safe, effective, and attractive transportation system that provides residents multimodal access to employment opportunities within the region.
- CC-G2** A community served by a light rail transit system that also is a catalyst for transit-oriented housing and commercial development within the station area.
- CC-G3** A community with transportation infrastructure necessary to ensure public safety, efficient access to services, and general quality of life.

TRANSPORTATION POLICIES

- CC-P1** Strive to make the Columbia City area safe and efficient for bicycles and pedestrians.
- CC-P2** Seek to improve east–west transit service that allows access to multiple employment centers and educational services.
- CC-P3** Maximize community benefits through the management of parking around the light rail station.
- CC-P4** Seek to replace and rehabilitate nonfunctional elements of the transportation system.
- CC-P5** Improve pedestrian safety and convenience along Rainier Avenue South and Martin Luther King Jr. Way South.
- CC-P6** Strive to make bus stops and transfer points safe, visible, comfortable, and efficient through the use of design techniques and by providing rider information.
- CC-P7** Maximize economic development and revitalization through appropriately designed station area development.
- CC-P8** Strive to maintain efficient goods mobility along Martin Luther King Jr. Way South.

ECONOMIC DEVELOPMENT GOALS

- CC-G4** A community with healthy businesses and healthy employment levels.
- CC-G5** A community with retail and service businesses that serve community needs, particularly pedestrian-oriented commercial development.
- CC-G6** A neighborhood that promotes entrepreneurship within the community.



COLUMBIA CITY
Residential Urban Village

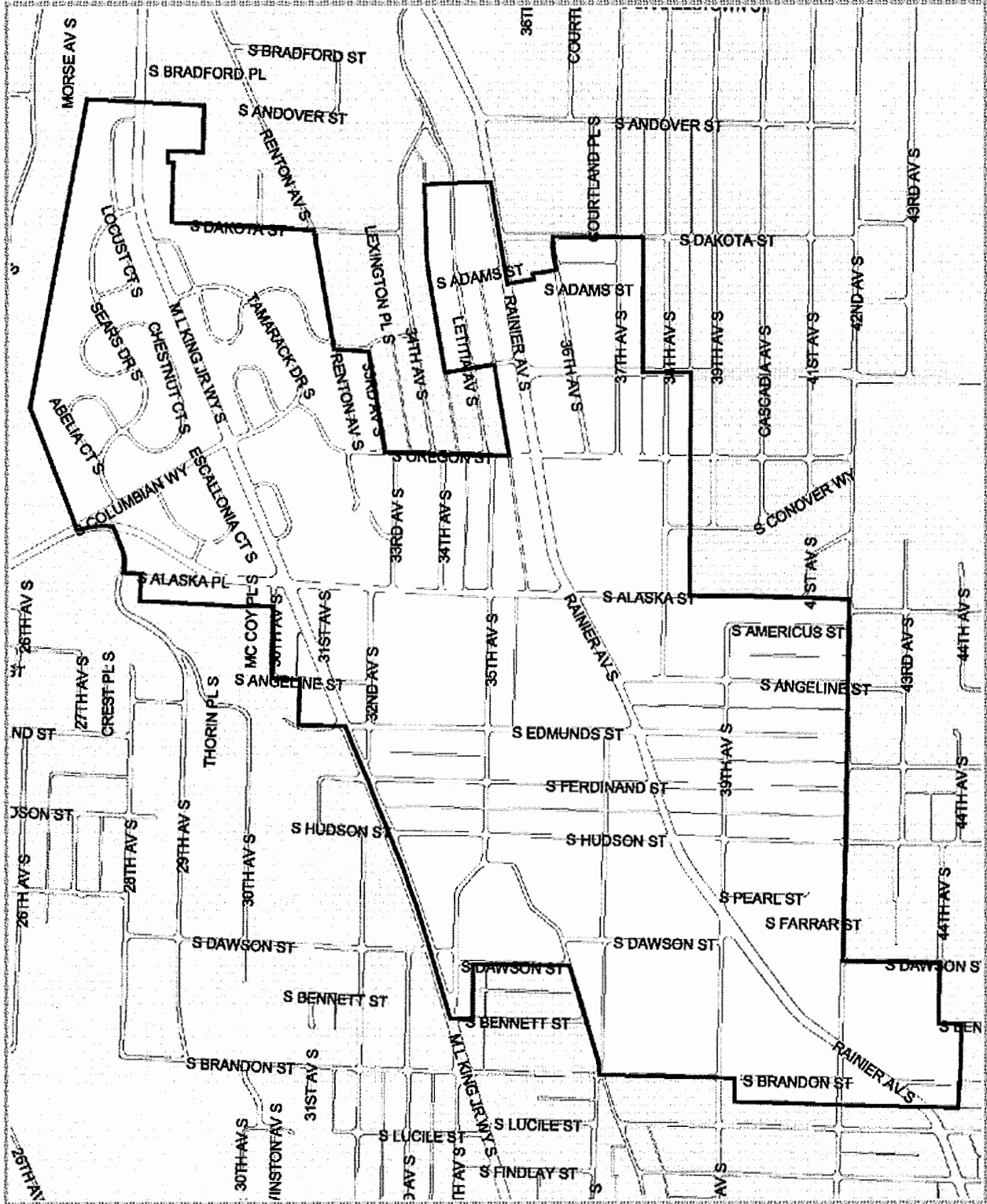

0 500 1000 Feet

— VILLAGE BOUNDARY
- - - EDGE OF PAVEMENT

ECONOMIC DEVELOPMENT POLICIES

- CC-P9** Encourage mixed-use and pedestrian-scale development within the Columbia City and Hillman City business districts.
- CC-P10** Strive to retain and build upon the unique pedestrian-friendly qualities of the Columbia City, Hillman City, and Genesee business districts.
- CC-P11** Support opportunities for business incubators and local business ownership within the community.
- CC-P12** Assist residents in gaining access to employment services, information technology, and centers of employment.
- CC-P13** Encourage the development of businesses that will increase the number of local jobs for professional, technical, and managerial positions, and that provide for the potential for career advancement.

HOUSING GOALS

- CC-G7** A community with healthy and attractive single-family residential areas.
- CC-G8** A community with a variety of available housing options for a mix of income levels and household sizes.
- CC-G9** A community that provides opportunities for owner-occupied housing for community residents.

HOUSING POLICIES

- CC-P14** Encourage the preservation of affordable housing resources through the rehabilitation of older existing homes.
- CC-P15** Strive to maintain existing neighborhood scale and character and promote transit-oriented development, where appropriate.
- CC-P16** Support opportunities for homeownership in the vicinity of Columbia City.
- CC-P17** Strive to provide the required infrastructure to support increases in housing density.
- CC-P18** Maximize light rail-related investments to ensure the development of quality housing with appropriate community amenities.
- CC-P19** Support the use of public/private partnerships to develop quality affordable housing.
- CC-P20** Encourage housing as part of mixed-use development projects, including live-work spaces, within the business districts; consider rezoning appropriate areas within the urban village to NC/R designations.



CC-P21 Support incentives for new housing development near high-capacity transit facilities.

CULTURAL & HUMAN RESOURCES GOALS

CC-G10 A community with adequate open space for the residential population.

CC-G11 A community with a library that serves community needs.

CC-G12 A community where social service needs are addressed in an efficient and noninvasive manner.

CULTURAL & HUMAN RESOURCES POLICIES

CC-P22 Use the P-Patch program as a means of increasing open space and neighborhood amenities.

CC-P23 Promote the incorporation of public art into the development of public and community facilities.

CC-P24 Provide library services that meet the needs of the Columbia City/Hillman City/Genesee community.

CC-P25 Seek to involve the Columbia City/Hillman City/Genesee community in planning efforts for the siting and use of essential community and public facilities in the neighborhood.

PUBLIC SAFETY/IMAGE GOALS

CC-G13 A neighborhood with strong community-based policing efforts.

CC-G14 A neighborhood with property and human rights protection for all residents.

CC-G15 A neighborhood with an attractive physical appearance and a positive image.

PUBLIC SAFETY/IMAGE POLICIES

CC-P26 Support police service that meets the needs of a growing population and reflects changing crime statistics.

CC-P27 Seek housing incentives for police officers to live within the community.

CC-P28 Strive to promote positive media portrayals of the surrounding area.

CC-P29 Develop strategies to address street litter and graffiti within the commercial centers.

CC-P30 Strive to improve security lighting near schools, parks, public facilities, parking lots, and in alleys.

- CC-P31** Support the continued availability of home improvement and business facade improvement funds, while strictly enforcing exterior maintenance codes.
- CC-P32** Promote a Crime Prevention Through Environmental Design (CPTED) program in the neighborhood.

Crown Hill/Ballard

ECONOMIC DEVELOPMENT GOAL

- CH/B-G1** A defined, vital, accessible mixed-use core with residential and commercial activity in the Ballard Hub Urban Village and Crown Hill Residential Urban Village.

ECONOMIC DEVELOPMENT POLICIES

- CH/B-P1** Employ economic development strategies that build on Ballard's history and welcome the variety of traditions represented in the area's population and businesses to create a family-friendly neighborhood that offers the best of Seattle living.
- CH/B-P2** Improve the attractiveness of the business areas in the Ballard Hub Urban Village and the Crown Hill Residential Urban Village to businesses, residents, and shoppers through creation of pleasant streetscapes and public spaces.
- CH/B-P3** Strive to create a mix of locally owned, unique businesses and regional and national retailers.
- CH/B-P4** Encourage tourists visiting the Ballard Locks to patronize businesses in the neighborhood.

RESIDENTIAL DEVELOPMENT GOALS

- CH/B-G2** A community with housing types that range from single-family to moderate-density multifamily.
- CH/B-G3** A civic complex in the core of the Ballard Hub Urban Village that incorporates moderate-density housing as well as public open space and other public and private services.

RESIDENTIAL DEVELOPMENT POLICIES

- CH/B-P5** Accommodate the majority of new housing units and increases in density in the central areas of the Ballard and Crown Hill urban villages.

CROWN HILL Residential Urban Village

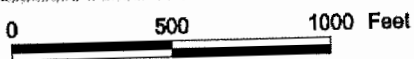
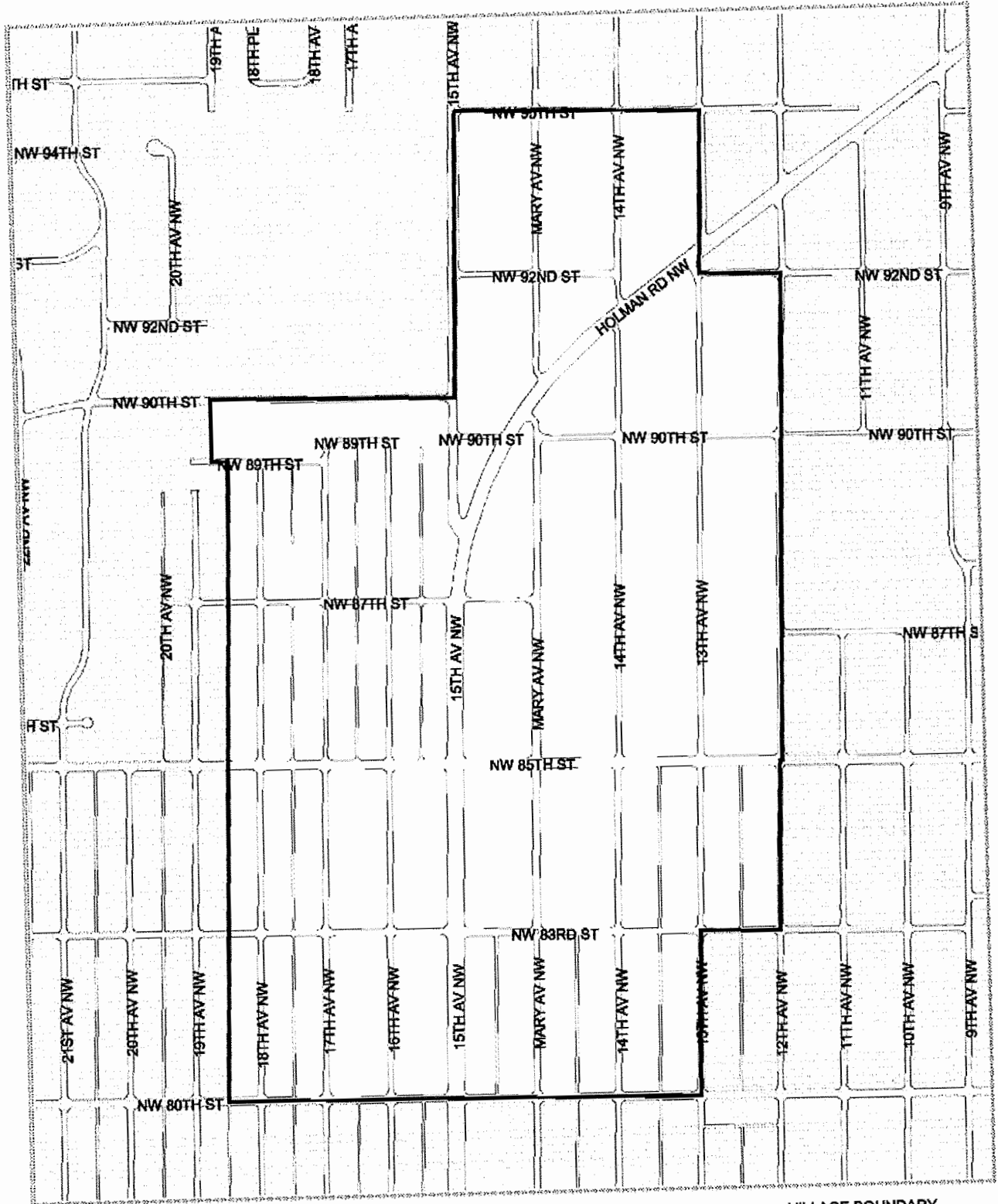

VILLAGE BOUNDARY
 EDGE OF PAVEMENT

BALLARD Hub Urban Village

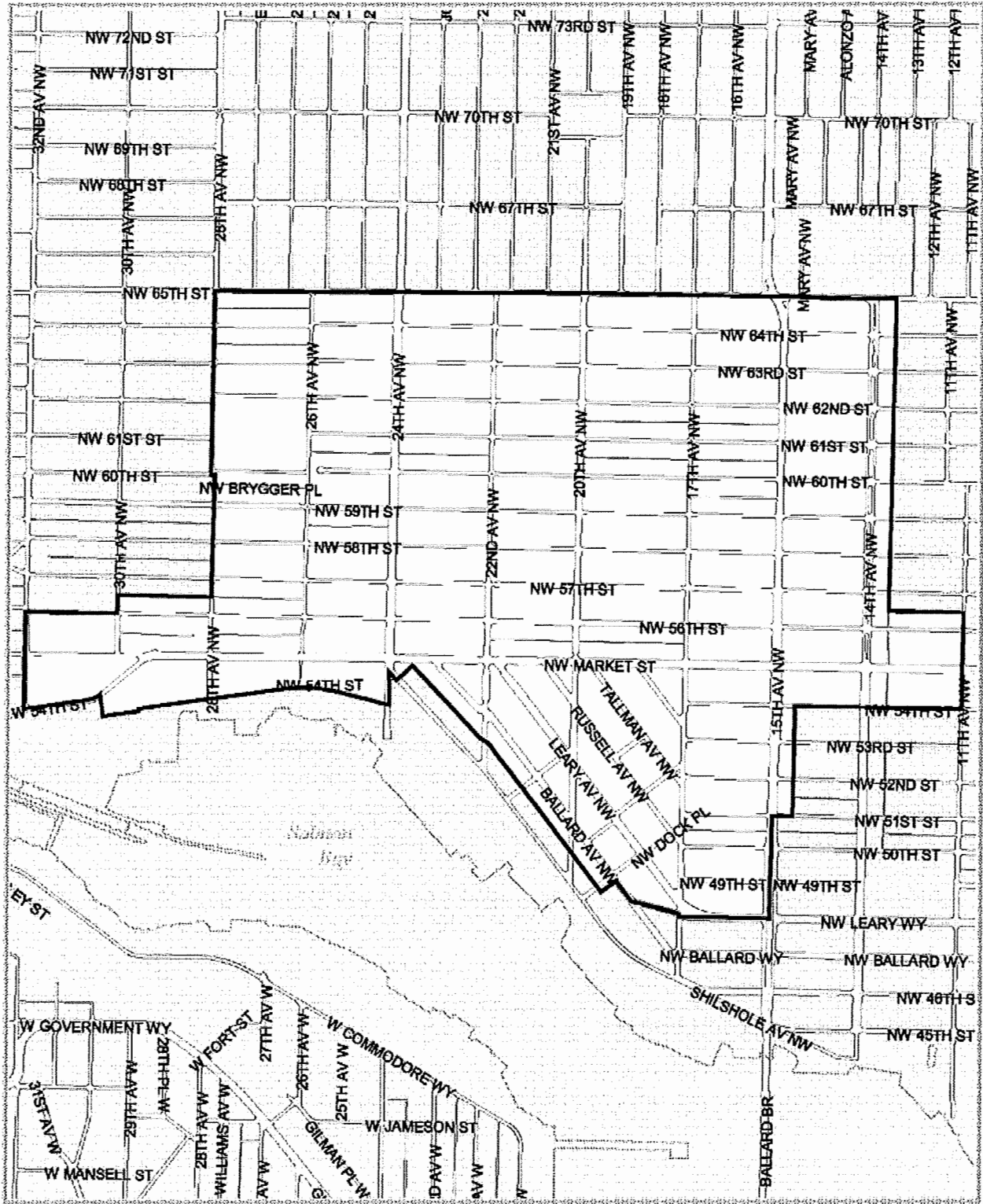

0 500 1000 Feet

— VILLAGE BOUNDARY
— EDGE OF PAVEMENT

CH/B-P6 Maintain the physical character of the single-family-zoned areas in the Crown Hill/Ballard plan area.

CH/B-P6.5 In the Crown Hill Residential Urban Village, single-family-zoned portions of split-zoned lots having an existing multifamily use may be rezoned to an abutting multifamily-zoning designation. This policy is intended to guide future rezone decisions and to lead to amendment of the Land Use Code by changing limits on the zones to which single-family areas may be rezoned within the Crown Hill Residential Urban Village, as prescribed by SMC 23.34.010.B.2.

TRANSPORTATION GOAL

CH/B-G4 A transportation system that supports residential, commercial and civic activity in the core of the Ballard and Crown Hill urban villages, and encourages people to use transit and nonmotorized transportation modes.

TRANSPORTATION POLICIES

CH/B-P7 Improve mobility for people using all modes of transportation to, within, and around the Ballard Hub Urban Village to increase retail, commercial, and civic activity. Improve mobility for people using all modes of transportation to, within, and around the Crown Hill Urban Village to serve the residents and businesses there.

CH/B-P8 Emphasize accessibility by transit, bicycle, and pedestrians in the Downtown Ballard area.

CH/B-P9 Preserve the function of 15th Avenue NW as a principal arterial and a major truck street, but strive to overcome the street as a barrier that isolates the neighborhood areas to the east and west from each other and to improve its contribution to the visual character of Crown Hill and Ballard.

CH/B-P10 Strive to improve the pedestrian environment along NW Market Street while retaining its function as a principal arterial.

CH/B-P11 Take advantage of present and future economic, cultural, and open space developments to enhance the bicycle and pedestrian network.

CH/B-P12 Work with the Regional Transit Authority and King County/Metro to ensure that Ballard residents and businesses are served by the Regional Transit Authority and King County/Metro systems.

RECREATION & OPEN SPACE GOAL

CH/B-G5 A neighborhood with open space, parks, and recreation sites, connected by a network of “green links,” that offer a full range of active and passive recreational opportunities to area residents and visitors, throughout Crown Hill/Ballard.

RECREATION & OPEN SPACE POLICIES

- CH/B-P13** Increase the range of recreation opportunities and types of open space available in the neighborhood. Encourage the development of new facilities, including, but not limited to passive parks, tennis courts, basketball courts, ballfields, play areas, marine and shoreline parks, pedestrian-friendly walkways, trails (including the Burke-Gilman), and gateways.
- CH/B-P14** Enhance existing open space and recreation sites and facilities throughout Crown Hill/Ballard.
- CH/B-P15** Create opportunities for people to experience the natural environment through the preservation of publicly owned forested areas, encouraging community gardening (P-Patches), and tree planting on private property and in the public right-of-way, and creating access to views and waterways.

ARTS & CULTURE GOAL

- CH/B-G7** A rich, diverse, and accessible cultural life that serves as the basis for neighborhood identity and helps build a livable community.

ARTS & CULTURE POLICIES

- CH/B-P16** Promote Ballard as a hub of arts, culture, and entertainment.
- CH/B-P17** Engage in cultural activities that promote community revitalization and historic preservation.
- CH/B-P18** Encourage the development of indoor and outdoor facilities in which cultural activities can take place.
- CH/B-P19** Address the lack of affordable live-work spaces for artists and others in Seattle through promoting the adaptive reuse of historic buildings in the Ballard Landmark District and other nearby areas as appropriate.
- CH/B-P20** Seek to attract industrial uses that could have a symbiotic relationship with the local arts community, including but not limited to, glass-blowing facilities, welding and metalwork shops, facilities that recycle materials into usable objects, woodworking facilities, or large-scale ceramics.
- CH/B-P21** Define and promote Crown Hill/Ballard's identity by establishing a series of welcoming gateways, such as landscaped areas or artworks, at key entry points to the neighborhood.

HUMAN SERVICES GOAL

- CH/B-G7** A caring community that nurtures and supports all its members, particularly the most vulnerable, including children, youth, and the elderly.



HUMAN SERVICES POLICY

- CH/B-P22** Create a strong network with multiple access points that link neighborhood organizations and service providers to fully utilize resources and to improve the awareness and use of services among those who need them in Crown Hill/Ballard.

CAPITAL FACILITIES & UTILITIES GOALS & POLICIES

The goals and policies of the capital facilities and utilities elements of the Comprehensive Plan express the vision of the Crown Hill/Ballard neighborhood.

Delridge

PARKS & OPEN SPACE GOAL

- D-G1** A Delridge community that is integrated with the natural environment, where open space and natural areas are preserved, interconnected, well maintained, and safe for wildlife and residents including children.

PARKS & OPEN SPACE POLICIES

- D-P1** Seek to create a comprehensive open space network in Delridge that integrates the residential and business environments with natural areas for public access and wildlife habitat.
- D-P2** Seek to protect from development: natural open space areas, wetlands, drainage corridors, and woodlands that contain prime wildlife habitat along the Longfellow Creek, Puget Creek, and Duwamish River drainage corridors and valley hillsides.
- D-P3** Strive to create a comprehensive system of trails for recreational hikers, walkers, and joggers, linking residential areas to parks and community facilities, schools, business nodes, and transit systems.
- D-P4** Work with community groups and neighborhood stakeholders to provide stewardship of the natural environment using appropriate city resources in partnership with community organizations, schools, and others.

LAND USE GOALS

- D-G2** A series of mixed-use activity nodes or centers along Delridge Way clustering commercial, business, entertainment, community uses, and public facilities.
- D-G3** The mixed-use neighborhood anchors provide services to residents in compact areas accessible from walkways, park trails, bikeways, transit routes, and local residential streets.



LAND USE POLICIES

- D-P5** Seek to create special identities for unique districts or places, particularly the neighborhood anchors along Delridge Way, using distinctive and unique gateways, pedestrian amenities, streetscape, and other furnishings and designs.
- D-P6** Strengthen the local Delridge business community by participating in public/private ventures to provide public benefits as appropriate to meet Delridge's long-range goals.
- D-P7** Seek to develop a pedestrian-oriented environment along Delridge Way that integrates adjacent storefront activities with transit, parking, bikeways, and walking areas. Seek to calm traffic on Delridge Way through the neighborhood anchors.
- D-P8** Seek to enhance pedestrian improvements and commercial services in the neighborhood anchor at Delridge and Andover. This anchor should serve as a major local employment center, while facilitating the flow of traffic through the node and onto the West Seattle bridge.
- D-P9** Seek to improve the "community campus" neighborhood anchor at Delridge and Genesee. This anchor should provide educational, recreational, cultural, and social opportunities (and potentially increased housing) to the neighborhood, by preserving and redeveloping the Old Cooper School and by coordinating, expanding, and improving programs between the local agencies.
- D-P10** Seek to improve the neighborhood anchor at Delridge and Brandon, through means including the continuation of the neighborhood commercial zone in the vicinity, along Delridge Way south to SW Juneau Street. This anchor should provide neighborhood-oriented retail and personal services and neighborhood-based city services (such as a neighborhood service center and library) for the nearby neighborhoods and existing neighborhood businesses.
- D-P11** To support the vision of the neighborhood anchor designated at Delridge and Brandon, LDT zoning is appropriate, along both sides of SW Brandon Street between 23rd Avenue SW and 26th Avenue SW; and along both sides of SW Findlay Street between 23rd Avenue SW and 26th Avenue SW.
- D-P12** Seek to improve the neighborhood anchor at Delridge and Sylvan/Orchard Ways, which will provide goods, services, entertainment, and transit services to the West Seattle area.

TRANSPORTATION GOALS

- D-G4** A transportation system that provides convenient access for local travel within the neighborhood, and access to principal employment, shopping, and entertainment activities in the surrounding area.
- D-G5** A community that provides safe, convenient, and efficient bikeway access to local and regional destinations.



TRANSPORTATION POLICIES

- D-P13** Encourage high-quality bus service with effective and efficient transfer opportunities, and facilities that provide adequate safety and security.
- D-P14** Seek to use park-and-ride lots for multiple purposes such as serving as off-peak period recreational trailheads.
- D-P15** Strive for high-quality roadway maintenance to ensure safe and efficient travel for pedestrians and vehicles.

HOUSING GOALS

- D-G6** A community with a range of household types, family sizes, and incomes—including seniors and families with children.
- D-G7** A community that preserves and enhances the residential character of single-family neighborhoods within the Delridge community while providing a range of housing types to fit the diversity of Delridge households.

HOUSING POLICIES

- D-P16** Seek to use regulatory tools or other means to preserve open space and natural features while increasing the variety of housing types available to the community
- D-P17** Encourage the rehabilitation of substandard housing.

COMMUNITY & CULTURE GOALS

- D-G8** A diverse community of neighborhoods with people from many cultures, longtime residents, and newcomers, young and old, people who own and rent homes and who work in a variety of jobs. A community where all people feel safe and welcome, have the opportunity to participate in their community and express what is most important to them, and which meets its residents' social, economic, and recreational needs.

COMMUNITY & CULTURE POLICIES

- D-P18** Seek to provide opportunities for multicultural sharing, education, understanding, and celebration through community participation and appreciation efforts, and through the provision of public meeting facilities.
- D-P19** Seek to inventory and promote neighborhood-based emergency preparation plans.
- D-P20** Strive to build strong partnerships with local crime prevention efforts.

- D-P21** Seek to involve the whole community to make services available to the broadest cross section of the community by developing programs that address the needs of individuals and families.
- D-P22** Seek to develop cultural programs (such as art, music, and theater), and support community programs. Seek to provide public facilities that support the cultural programs.

PLAN STEWARDSHIP GOAL

- D-G9** A community fully involved in efforts to implement the neighborhood plan, and to maximize the efficient use of available resources.

PLAN STEWARDSHIP POLICIES

- D-P23** Promote partnerships with projects that can leverage City efforts toward the implementation of the Delridge neighborhood plan.
- D-P24** Support community-based efforts to implement and steward the plan.

ECONOMIC DEVELOPMENT POLICIES

- D-P25** Seek to create greater employment and shopping opportunities within the Delridge neighborhood.
- D-P26** Seek to participate with other public agencies and private interests in marketing projects, labor force training programs, and other efforts that support community residents in need of employment.
- D-P27** Encourage local business development opportunities, particularly for small businesses that may be owned by or employ Delridge residents.

Downtown Neighborhood Plan

Downtown Urban Center

Discussion

The following goals are intended to further define the direction for Downtown growth, investment, and development.

PRE-EMINENT REGIONAL CENTER GOAL

DT-G1 Maintain Downtown Seattle as the most important of the region's urban centers—a compactly developed area supporting a diversity of uses meeting the employment, residential, shopping, culture, service, and entertainment needs of the broadest range of the region's population.

ECONOMIC DEVELOPMENT GOAL

DT-G2 Encourage economic development activities consistent with the Comprehensive Plan to attract and retain businesses and to expand employment and training opportunities for Seattle area residents.

CULTURE & ENTERTAINMENT GOAL

ST-G3 Strive to reinforce Downtown as a center of cultural and entertainment activities to foster the arts in the city, attract people to the area, create livable neighborhoods, and make Downtown an enjoyable place to be shared by all. Encourage facilities for artists to live and work in Downtown.

URBAN FORM GOAL

DT-G4 Use regulations in the Land Use Code and other measures to encourage public and private development that contributes positively to the Downtown physical environment by:

1. enhancing the relationship of Downtown to its spectacular setting of water, hills, and mountains;
2. preserving important public views;
3. ensuring light and air at street-level and in public parks;
4. establishing a high-quality pedestrian-oriented street environment;
5. reinforcing the vitality and special character of Downtown's many parts;
6. creating new Downtown parks and open spaces at strategic locations;
7. preserving Downtown's important historic buildings to provide a tangible link to the past;
8. adequately mitigating impacts of more intensive redevelopment on the quality of the physical environment.

**DOWNTOWN
Urban Center**

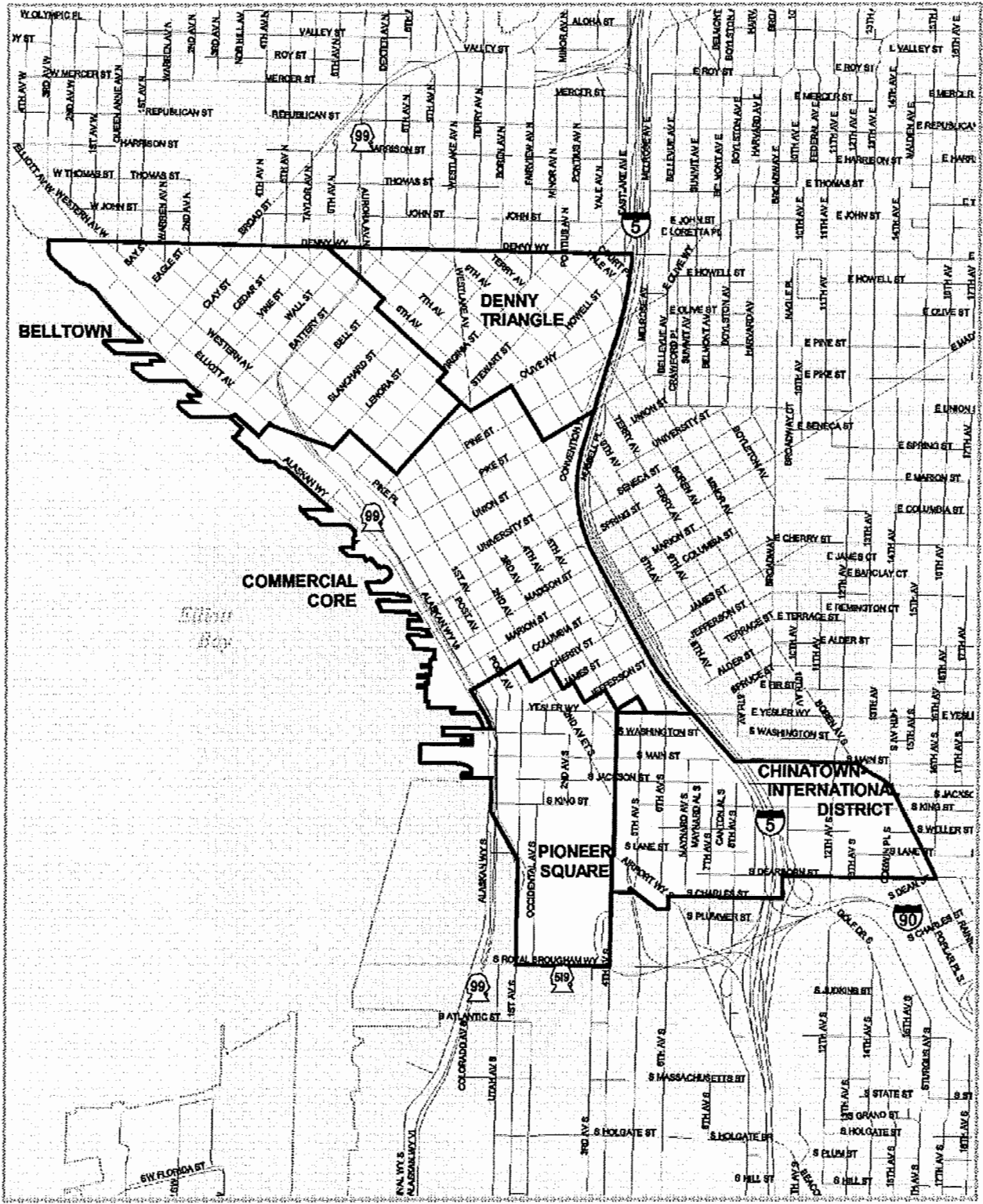

OFFICE CONCENTRATION GOAL

DT-G5 Seek to accommodate the needs of a wide range of office and commercial activities by concentrating the densest office activity in a compactly developed core area bound by the government center, I-5, the retail core, and the lower-intensity areas along First Avenue. Generally maintain areas adjacent to the office core for additional concentrations of office development, along with a mix of other uses, to accommodate office expansion and provide a transition with less intensive development in adjacent areas like Pioneer Square and the Chinatown/International District. Seek to accommodate the largest share of Downtown employment growth in these combined districts. Concentrations of office use should occur:

1. where such concentrations already exist;
2. where existing infrastructure is adequate or can be made adequate;
3. where the existing and planned transportation system has the capacity to handle increased demand;
4. where healthy concentrations of other desirable uses such as retail and housing will not be displaced; and
5. where such concentrations are consistent with neighborhood development objectives.

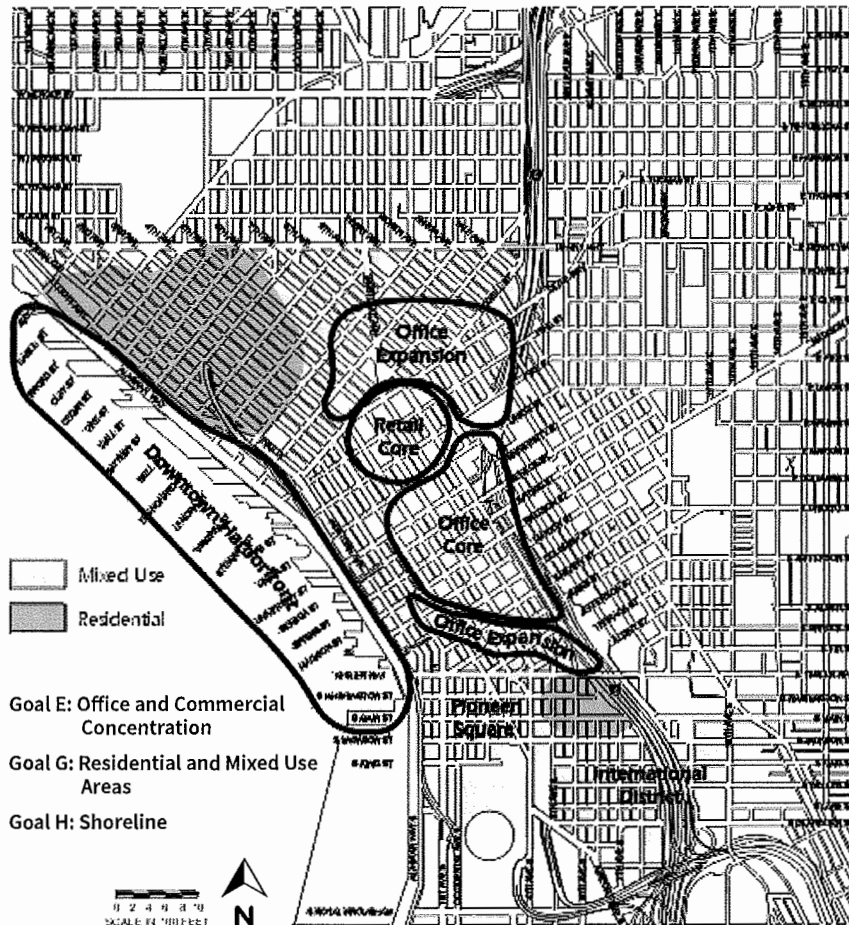

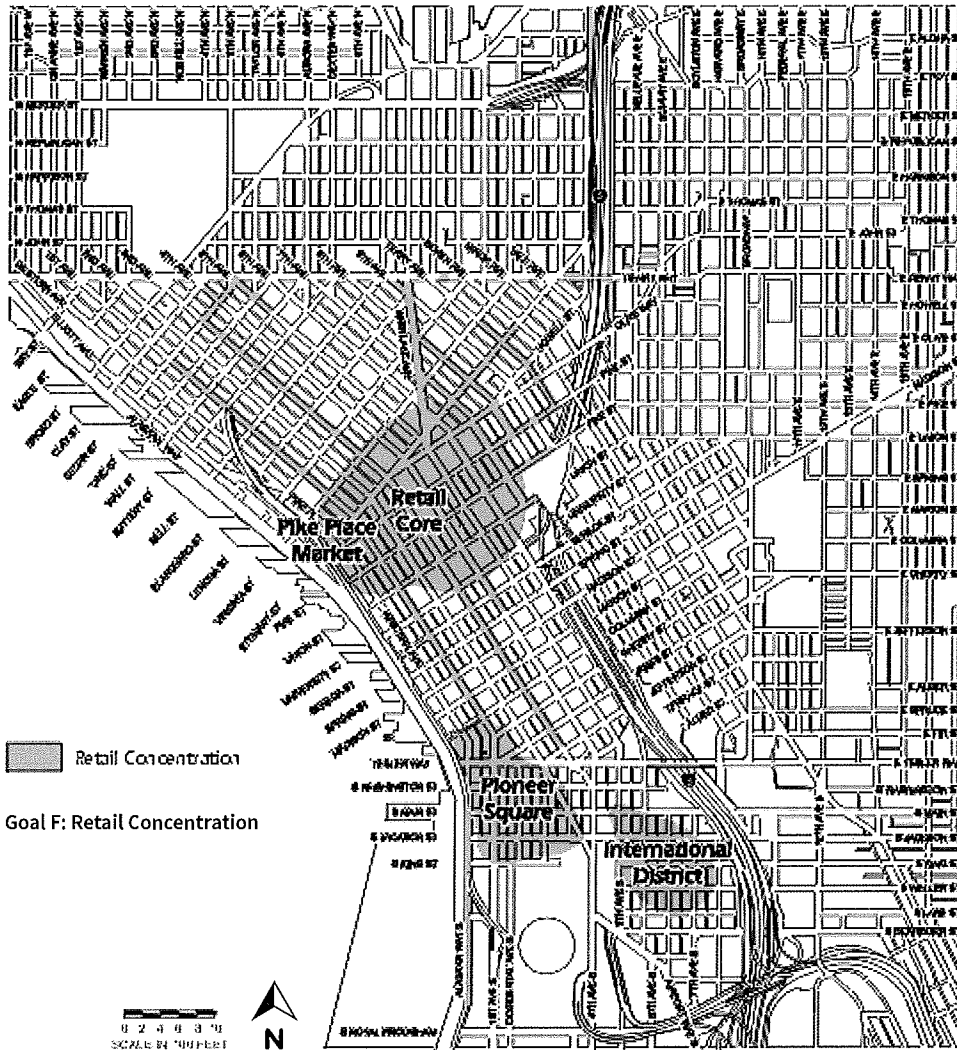

RETAIL CONCENTRATION GOAL

DT-G6 Reinforce the concentrated shopping function of the retail core; preserve the general form and scale of the area; and protect the area from high-density uses that conflict with the primary retail function. Other concentrations of retail activity should be encouraged where they already exist or where such uses are desirable to encourage an active pedestrian environment or focal point of neighborhood activity.

RESIDENTIAL & COMMERCIAL MIXED-USE AREAS GOAL

DT-G7 Encourage a mix of housing, employment, and related support activities in a crescent bounding the office and retail cores. Within this crescent, foster areas that are predominantly residential in character, including Chinatown/International District and Belltown. Encourage housing as the primary use in these area and limit the type and scale of nonresidential uses allowed to ensure that such development is compatible with a residential neighborhood.

Use the adopted policies of neighborhood plans for the five Downtown urban villages for further guidance in defining the appropriate mix of activities to accommodate Downtown growth targets for employment and housing, and to meet neighborhood development objectives, including identifying areas that are to be predominantly residential in character.

SHORELINE GOAL

DT-G8 Encourage revitalization of the harborfront in order to strengthen maritime activities, maintain historic characteristics, and enhance opportunities for public access, consistent with the shorelines goals and policies established in the Comprehensive Plan Land Use element.

TRANSPORTATION GOAL

DT-G9 Support transportation improvements that complement and reinforce desired land use patterns. Strive to accommodate growth in peak hour travel primarily by transit, and encourage transit and pedestrian travel as the primary means of internal circulation. Discourage vehicular traffic passing through Downtown on surface streets with a destination elsewhere. Recognize the importance of the automobile as a means of access to Downtown for nonwork trips.

HOUSING GOAL

DT-G10 Seek to significantly expand housing opportunities in Downtown Seattle for people of all income levels, with the objectives of:

1. accommodating household growth;
2. at a minimum, maintaining the existing number of occupied low-income units; and
3. developing a significant supply of affordable housing opportunities in balance with the market resulting from the growth in Downtown employment. Allow housing in all areas of the Downtown Urban Center except over water and in industrial areas, where residential use conflicts with the primary function of these areas. Target public resources and private development incentives, such as density regulations and development standards that encourage housing, to promote the amount and type of housing development necessary to achieve Downtown neighborhood housing goals. Address, in part, the impact of high-density commercial development on the Downtown housing supply by allowing increased development density through voluntary agreements to produce and/or preserve housing through cash contributions, floor area bonuses, or the transfer of development rights.

CHILD CARE & HUMAN SERVICES GOAL

DT-G11 Seek to address the increased demand for child care services generated by increased employment growth Downtown and support the provision of adequate human services to meet the needs of Downtown residents and workers.

PUBLIC SAFETY GOAL

DT-G12 Promote public safety by encouraging conditions that contribute to a safe and friendly urban environment including: maintaining streets and open spaces as active, well-designed public places; supporting twenty-four-hour activity in a manner that minimizes conflicts among different uses; accommodating a mix of people from all income, age, and social groups; and providing for needed human services within the limits of a neighborhood's capacity to support them.

NEIGHBORHOODS GOAL

DT-G13 Five neighborhoods compose the Downtown Urban Center for planning and growth monitoring purposes: Belltown, the Denny Triangle, the Commercial Core, Pioneer Square, and Chinatown/International District. Recognize and seek to enhance the varied character of these neighborhoods and other distinctive areas within Downtown. Use the adopted policies of neighborhood plans to help define desirable characteristics for these neighborhoods.

LAND USE REGULATION POLICIES

DT-LUP1 Recognize and enhance the urban center designation and varied character of Downtown neighborhoods and provide direction for growth and change by dividing Downtown into areas that are intended to serve primary land use functions. Classify areas of Downtown according to one of the following primary functional designations:

- Office
- Retail
- Mixed-use Commercial
- Mixed-use Residential
- Harborfront
- Industrial

In addition, maintain consistency between these designations and the function and purpose of special districts as established by the City Council.

DT-LUP2 Allow a wide range of uses Downtown, consistent with the goals to maintain Downtown's regional importance, create a strong residential community, improve the physical environment, and add activity and diversity to the areas of varied character. Restrict or prohibit uses that are not compatible with the desired character and function of specific areas.



DT-LUP3 Recognize the diversity of Downtown’s many parts and the different development objectives for these areas by varying regulation of uses, development density, and physical form among land use district classifications, including the following:

- Downtown Office Core-1 (DOC-1)
- Downtown Office Core-2 (DOC-2)
- Downtown Retail Core (DRC)
- Downtown Mixed Commercial (DMC)
- Downtown Mixed Residential (DMR)
- Pike Market Mixed (PMM)
- Pioneer Square Mixed (PSM)
- International District Mixed (IDM)
- International District Residential (IDR)
- Downtown Harborfront-1 (DH-1)
- Downtown Harborfront-2 (DH-2)

Base the appropriate classification for an area on the district’s intended function and other locational criteria.

DT-LUP4 Use Downtown land use district classifications to specify the intended function of an area and guide future development and change. Recognize certain areas characterized by a specific activity and intensity of development, such as the office and retail cores, and consider the factors critical to the success of that activity, such as access to transportation, topographic conditions, or the presence of a particular amenity.

Where it is desirable to protect or promote a specific function, encourage uses at an appropriate intensity that are related to or compatible with that function, and restrict or discourage conflicting uses.

Recognize the following desired functions for the different land use districts:

Downtown OFFICE CORE-1 (DOC-1)

Area of most concentrated office activity. The DOC-1 land use district is intended to:

- allow the highest density of commercial development Downtown, with development standards regulating building design to reduce adverse impacts, including impacts on sidewalks and other public areas;
- accommodate a large share of Downtown’s future employment growth within this district where the existing and planned infrastructure can accommodate growth; and
- accommodate other uses, including housing, retail, hotels, and cultural and entertainment facilities, that complement the primary office function while adding diversity and activity beyond the working day.

Downtown OFFICE CORE-2 (DOC-2)

Areas adjacent to the office core appropriate for office expansion and where a transition in density to mixed-use areas is desirable. The DOC-2 land use district is intended to:



- accommodate major office development to reduce pressures for such development in the retail core and adjacent mixed-use and residential areas; and
- accommodate a mix of other activities, in addition to primary office use, to add diversity, particularly beyond the hours of the normal working day, while providing for scale and density transitions to adjacent areas.

Downtown RETAIL CORE (DRC)

Area containing the major department stores and having the greatest concentration of Downtown’s retail activity. The DRC land use district is intended to:

- provide the principal center of shopping for both Downtown and the region;
- allow uses other than retail with the general intent that they augment but do not detract from this primary function, and promote housing in the area to complement its principal retail function; and
- maintain an active and pleasant street-level environment through development standards specifically tailored to the unique function and character of this area.

Downtown MIXED COMMERCIAL (DMC)

Areas adjacent to the office core, office expansion areas and retail core that provide a transition in the level of activity and scale of development. Areas designated DMC are characterized by a diversity of uses. The DMC land use district is intended to:

- permit office and commercial use, but at lower densities than in the office areas;
- encourage housing and other uses generating activity without substantially contributing to peak-hour traffic; and
- promote development diversity and compatibility with adjacent areas through a range of height limits.

Downtown MIXED RESIDENTIAL (DMR)

Areas outside special review districts identified for development of a predominantly residential community in conformance with the Downtown Urban Center goals. The DMR land use district is intended to:

- maintain areas primarily for residential use;
- allow nonresidential uses with the general intent that they reinforce and do not detract from the primary function of the area;
- promote diversity and harmony with existing development and allow a variety of housing forms through multiple height, mix of use, and density classifications;
- control tower development and promote a pleasant street-level environment conducive to a high-density residential neighborhood.



Within the DMR area, one of the following two mixed-use designations applies to achieve subarea objectives.

- A. **Downtown Mixed Residential/Residential (DMR/R).** The DMR/R designation is more appropriate to areas predominantly residential in character or containing large amounts of underutilized land allowing for a sufficient concentration of new housing to establish a predominantly residential character. While nonresidential uses may be present, they should be of modest scale, likely to change in the future, or neighborhood serving in character.
- **Downtown Mixed Residential/Commercial (DMR/C).** The DMR/C designation is more appropriate to those areas containing housing or having the potential for concentrations of housing, but where, because larger-scale commercial development exists and is likely to remain, limited commercial development accommodating modest employment growth is appropriate as part of the overall mix of uses.

PIONEER SQUARE MIXED & SPECIAL REVIEW DISTRICT (PSM)

Area within the Pioneer Square Preservation District. The PSM designation and the Pioneer Square Preservation District regulations are intended to:

- recognize the historic nature of the area and allow flexibility and discretion in controls, regulations, and guidelines for both present conditions and those that may develop in the future; and
- encourage mixed-use development compatible in use and scale with existing development in Pioneer Square.

Allow districts of varying height within the PSM area to achieve different development objectives, including maintaining a development scale compatible with existing conditions in the historic core, providing incentives for housing through higher height limits for residential use in appropriate areas on the edge of the core, and providing an appropriate transition in scale between the core and adjacent, more intensive Downtown zones.

INTERNATIONAL DISTRICT MIXED & SPECIAL REVIEW DISTRICT (IDM)

Areas of the International Special Review District identified for mixed-use development. The intent of the IDM land use district is to:

- recognize and promote the area's unique social character, mix of use, and urban design character through the IDM designation and the regulations of the International Special Review District;
- encourage a wide range of uses, housing above the street-level, and the rehabilitation of existing buildings; and
- allow flexibility and discretion in controls, regulations, and guidelines through the IDM designation and Special Review District regulations, both for present conditions and those that may develop in the future.

Allow districts of varying height to achieve objectives related to the desired scale of development and mix of activity, including maintaining a development scale



compatible with existing conditions in the district core, providing incentives for housing through higher height limits for residential use in appropriate areas, providing a compatible scale relationship with development in adjacent areas, and providing flexibility to balance development objectives through limited increases in height allowed under the Planned Community Development Process.

INTERNATIONAL DISTRICT RESIDENTIAL & SPECIAL REVIEW DISTRICT (IDR)

Areas of the International Special Review District identified for development as a predominantly residential neighborhood in conformance with the Downtown Urban Center goals. The IDR land use district is intended to:

- maintain areas primarily for residential use;
- allow other uses compatible with housing, with the general intent that they reinforce and do not detract from the primary residential function of the area; and
- recognize and promote the area's unique social and urban design character through the IDR designation and the regulations of the International Special Review District.

Downtown HARBORFRONT-1 & SHORELINE ENVIRONMENT (DH-1)

Waterfront lots and adjacent harbor areas within the Urban Harborfront Shoreline Environment established in the Seattle Shorelines Master Program. The DH-1 land use district, in conjunction with the Seattle Shorelines Master Program, is intended to:

- encourage economically viable marine uses to meet the needs of waterborne commerce;
- facilitate the revitalization of Downtown's waterfront;
- provide opportunities for public access and recreational enjoyment of the shoreline;
- preserve and enhance elements of historic and cultural significance;
- preserve views of Elliott Bay and the land forms beyond;
- promote the preservation and rehabilitation of groupings of piers having an identifiable historic maritime character within the Historic Character Area; and
- allow flexibility in appropriate development standards as an incentive to include a significant water dependent use on waterfront lots to encourage the retention and development of water-dependent uses in the Downtown harborfront consistent with the Seattle Shoreline Master Program.

Downtown HARBORFRONT-2 (DH-2)

Areas partially within a shoreline environment where development potential offers the opportunity to enhance public access to and enjoyment of the waterfront. The DH-2 land use district is intended to:

- allow a mix of uses to facilitate the objectives of public access, enjoyment, and recreation;



- include use and bulk regulations to carry out shoreline goals and preserve views of the water as appropriate for areas partially within a shoreline environment,
- favor a diversity of uses and buildings of small scale; and
- address public open space as a priority in this area through incentives for open space integrated with other public access improvements.

PIKE MARKET MIXED (PMM)

The intent of the PMM land use district is to:

- recognize and preserve the unique character, scale, and function of the Market and its surroundings; and
- allow development of a compatible mix of uses.

DT-LUP5 Apply district designations, as appropriate, to create or reinforce areas with distinctive functions and to provide desirable transitions between areas with different functions and levels of activity. Use the following locational criteria to guide establishing the district boundaries that define areas according to intended function:

1. **Scale and Character of Development.** The appropriate district designation should: reinforce special areas such as Pioneer Square, the International District, and the retail core that are distinguished by a consistent scale and character of development. Employ development standards that respect established patterns, both in physical scale and in nature of activity; or provide direction for the scale and character of future development to create the desired physical environment in some parts of Downtown where it is appropriate to accommodate significant change.
2. **Transportation and Infrastructure Capacity.** Consider locations where the existing and planned transportation network can support additional trips generated by new development as most appropriate for district designations that accommodate significant employment growth. The location of I-5, the transit tunnel, and station locations define those areas of Downtown with the greatest accessibility.
3. **Relationship to Surrounding Activity.** Consider relationships among major areas as a major factor in establishing land use district boundaries, including both well-defined edges, such as I-5 or significant topographic changes, that clearly distinguish one area from another, as well as more subtle transitions resulting from a gradual change in use or development intensity.

DT-LUP6 Use overlay and district regulations to further specific goals and objectives for areas of Downtown where guidance is needed to protect and promote special qualities. Recognize sensitive environmental, physical, historical, or cultural qualities of these areas by coordinating land use district classifications with overlays as appropriate.

DT-LUP7 Allow flexibility in the application of regulations and standards for major development on large sites or areas of Downtown through the planned community development procedure. Limit the application of this procedure to proposals for



major development that would substantially change the character of an area or for which design flexibility provides for significant public benefit, with special attention to public benefits identified in adopted neighborhood plans. Provide for consideration of the public benefit and the imposition of conditions that would mitigate negative impacts prior to approval of any planned community development.

DT-LUP8 Generally limit the density of uses that generate employment through a floor area ratio (FAR), and the density of residential uses generally through the combination of height and bulk regulations.

Apply a base and maximum limit on permitted density, as expressed by a floor area ratio (FAR), in areas able to accommodate more intensive development provided that impacts associated with the added density are addressed. Reflect in the base FAR limit the density of employment that the City will accommodate without additional mitigation measures.

Reflect in the maximum FAR limit the additional density above the base that may be allowed through bonuses or TDR, or both, as appropriate for the zone or district, if appropriate measures are taken to mitigate specified impacts.

Consider density incentives to encourage development on smaller lots to add diversity to the scale of development in high-density office core areas.

Floor Area Limit Exemptions. Allow exemptions from floor area ratio limits to recognize the lower impacts of certain uses and encourage certain uses that generate minimal peak-period commute trips, support pedestrian activity and transit use, and contribute to the overall diversity of activity Downtown, increasing its attractiveness as a place to live, work, and recreate.

DT-LUP9 Allow additional floor area above the base densities, and consider adding greater height where appropriate, up to maximum limits, in specified Downtown areas where it is desirable to accommodate growth, through bonuses and transfer of development rights. In determining conditions for bonus floor area, consider measures to mitigate impacts of higher density development on the Downtown environment, including such resources as affordable housing, public open space, child care, human services, and pedestrian circulation.

Allow transfer of development potential from one site to another in certain circumstances, consistent with policy LU 11. When transferable, development potential is referred to for convenience as “transferable development rights,” or “TDRs,” but such terms do not mean that there is any legal right vested in the owner of TDRs to use or transfer them. The conditions and limitations on the transfer or use of TDRs may be modified from time to time as the City may find appropriate to implement the policies of the Comprehensive Plan in light of experience and changing conditions.

Allow transfer of development rights from eligible sending sites to project sites in combination with the use of bonuses. Consider allowing TDRs to be used for all floor area above the base FAR under some conditions.

Recognize different impacts associated with density increases achieved through different options for increasing floor area.



Priorities for granting floor area increases:

Consider allowing greater use of incentives for open space and other neighborhood amenities in mixed-use residential areas where floor area incentive programs apply to respond to the greater impact of growth on these public resources in high-density residential environments.

DT-LUP10 Allow voluntary agreements to earn floor area increases above the base density in certain Downtown zones. Consider allowing such options as:

1. providing low-income housing,
2. providing child care facilities,
3. making payments to the City to fund such facilities,
4. providing certain amenity features, combined with the use of options 1 and 2 or with the use of TDRs, or both.
 - Consider allowing bonus floor area for certain amenity features, such as open space, on or near the development site that directly benefit both the public and the project by serving the increased employment population and improving conditions in the immediate environment to support the increased density allowed.

Some facilities and amenity features that may be eligible for bonuses are identified under the following policies:

1. Policy HO 3: Housing Bonus Program
2. Policy OS 5: Open Space Bonus Amenity Features
3. Policy HS 1: Child Care Bonus
 - If bonus cash contributions are provided, they should be used to address impacts associated with increased density Downtown, such as impacts on housing resources and child care.

Amount of Benefits for Floor Area Increases. The nature and quantity of housing and child care facilities or contributions for such facilities under voluntary agreements, in relation to the additional floor area allowed, should generally reflect a portion of what is necessary to mitigate the impacts of increased development and the cost to provide these facilities. Facilities provided for bonuses are not expected to fully mitigate such impacts.

Additional types of facilities or amenity features may be added to address future needs, and existing types of facilities or features may no longer be eligible for bonuses, based on changing assessments of impacts, needs, capacity, and public priorities.

Special Criteria. Because of their complexity and the need to adapt them to special circumstances, subject certain bonus features to special criteria and review by the director of DPD. Include among bonus features subject to special criteria urban plazas, transit station access, and public atriums.

DT-LUP11 Provide incentives to maintain variations in building scale, create public open space, and preserve buildings and uses that are scarce public benefit resources through allowing transfer of development rights. Consistent with priorities for use of development incentives, limit the sites that may transfer development rights. Among sites eligible to transfer development rights, consider including:

1. housing with a minimum amount of residential floor area occupied by units affordable to households with incomes at or below 50 percent of median income;
2. Seattle landmarks in Downtown areas not subject to special review district or historical district provisions;
3. Seattle landmarks and other historic properties within the Pioneer Square Preservation District and the International Special Review District;
4. publicly available open space meeting minimum size and other standards; and
5. sites on the same block as the receiving site in high-density areas where it is desirable to retain varied building scale.

Limitations on Sending and Receiving Site Locations. Limit sending and receiving sites so as to promote development that is consistent with the development objectives of different land use districts and to promote other goals and policies of this Plan. The proportion of floor area that may be gained through TDRs from particular sources may be limited. Limit sites eligible to transfer TDRs to those that provide limited Downtown resources of public benefit, such as low-income housing, designated landmark structures or historic structures in historic districts, and open space, except where TDRs are allowed to be sent to nearby lots in areas where a variable scale of development is desired.

DT-LUP12 Engage in a joint pilot program with King County to further regional growth management goals by providing incentives to protect and maintain rural character and direct residential growth to urban centers through the transfer of development credits from certified rural properties to sites in specified Downtown areas. After an initial period, evaluate the performance of the program and the availability of continued funding from King County, and determine whether to continue, modify, or terminate the program.

URBAN DESIGN POLICIES

DT-UDP1 Encourage the preservation, restoration, and re-use of individual historic buildings and groupings of buildings threatened by development pressure through development regulations and incentives.

DT-UDP2 Consider designating as Seattle landmarks additional Downtown buildings and groups of buildings that impart a strong sense of character and place through a combination of historic importance and significance in terms of architectural, cultural, and/or social interest.



DT-UDP3 Provide the following development incentives to increase the attractiveness of preserving landmark structures and encourage adaptive reuse of historic resources:

Seattle Landmarks Transfer of Development Rights. Allow the transfer of development rights from designated Seattle landmarks located in Downtown areas where these resources are most threatened by development pressure. Subject transfers from designated Seattle landmarks to limits, including limits on sending and receiving sites implementing Policy LU 11: Transfer of Development Rights, and to other appropriate conditions to promote the rehabilitation and public enjoyment of designated landmark features.

Incentives. Provisions for allowing floor area above the base should not create incentives for the demolition of designated landmark structures.

Floor Area Allowance. Within Downtown mixed-use residential zones where the floor area of existing structures may exceed the density limits for nonresidential use, provide an economic incentive for the use and rehabilitation of designated Seattle landmarks by allowing the total existing floor area of a landmark structure committed to long-term preservation to be occupied by permitted nonresidential uses, regardless of FAR limits and without use of bonuses or TDR. Allow this incentive under the conditions that there is no reduction in the amount of floor area occupied by residential use prior to rehabilitation nor any increase in the floor area in nonresidential use beyond the total floor area of the structure prior to rehabilitation. Consider limiting this incentive to lots not benefiting from other incentives, such as TDR transfers.

DT-UDP4 Regulate the height of new development generally to:

1. accommodate desired densities of uses and communicate the intensity and character of development in different parts of Downtown;
2. protect the light, air, and human-scale qualities of the street environment, particularly in areas of distinctive physical and/or historic character; and
3. provide transition to the edges of Downtown to complement the physical form, features and landmarks of the areas surrounding Downtown.

DT-UDP5 Prescribe for all areas of Downtown specific height limits that reflect topographic conditions and a strong relation to the street pattern and the overall urban form of Downtown and adjacent areas. Use the following criteria in determining appropriate height limits and provisions for limited additions or exceptions:

1. **Transition.** Generally taper height limits from an apex in the office core toward the perimeter of Downtown, to provide transitions to the waterfront and neighborhoods adjacent to Downtown.
2. **Existing Character.** Through height limits, recognize and enhance the existing scale and unique character of areas within Downtown including the retail core, office core, the Pike Place Market, Belltown, the waterfront, Pioneer Square, and the Chinatown/International District.
3. **Development Regulations.** Coordinate development regulations with height limits.

4. **Boundaries.** Coordinate height limits and land use district boundaries.
5. **Height Above Specified Limits.** Increased height beyond the limits specified for Downtown zones may be considered only when the public purpose served by the additional height justifies higher buildings, and the height increase is generally consistent with the criteria above.

DT-UDP6 Employ development standards that guide the form and arrangement of large buildings to reduce shadow and wind impacts at the street-level, promote a human scale, and maintain a strong physical relationship with the pedestrian environment. In areas where consistency of building form is important to maintaining an identifiable character and function, regulate building bulk to integrate new and existing development.

Limit the bulk of tall buildings in residential areas to provide for light, air, and views at street-level and reduce the perceived scale of the buildings.

Vary development standards to reduce impacts of large-scale buildings by district consistent with the desired scale and development pattern in the area.

DT-UDP7 Consider allowing under appropriate conditions the transfer of unused development rights between nearby sites, regardless of the use on the sending site, to encourage a diversity of building scale within office and retail districts, subject to limits on sending and receiving sites and on the amounts of square feet that may be used on receiving sites. **See Policy LU 11: Transfer of Development Rights.**

DT-UDP8 Designate as view corridors street segments providing street-level views of important natural features, which may include views to Elliott Bay, West Seattle, Mount Rainier, and the Olympic Mountains. Protect view corridors through regulations controlling actions within the public right-of-way, as well as through reasonable development standards for abutting property, consistent with Policy UD 9: View Corridor Setbacks. Consider impacts on designated view corridors in the evaluations of street vacations and encroachments.

DT-UDP9 Require setbacks on specified segments of designated view corridors where there is potential for maintaining a scope of view wider than the street right-of-way from uphill areas as redevelopment occurs. On sites abutting these street segments, require setbacks of the upper portions of buildings to allow for a wider view corridor than would occur if development extended to the street property line. Adjust the height and depth of these setbacks in relation to topography to balance multiple objectives of providing a pedestrian-oriented building base integrated with the established development pattern, maintaining a wide scope of view, and minimizing impacts on the development potential of abutting properties where setbacks are required.

DT-UDP10 As appropriate for each land use district and type of street environment desired, maintain a strong relationship between buildings and the sidewalk environment through specific street-level development standards. The standards are intended to:

1. make streets enjoyable and pleasant places to be;
2. provide visual interest for pedestrians;



3. provide a comfortable sense of enclosure along the street;
4. integrate individual buildings within the streetscape;
5. bring the activity occurring within buildings into direct contact with the street environment;
6. provide strong edges to clearly define public open spaces; and
7. ensure adequate conditions to support higher density development occurring on abutting properties.

Address through street-level development standards the major components of the streetscape. Consider regulating or requiring features including:

1. street walls,
2. facade transparency,
3. blank wall limitations,
4. overhead weather protection,
5. street landscaping, and
6. screening of parking.

Coordinate street-level development standards with the Pedestrian Street Classification System, established by Policy T 10: Street Classification System. Vary standards according to the classification of the street to reflect the predominant character of the area and the street's relative importance to pedestrian circulation.

Where appropriate, allow flexibility necessary to accommodate desirable public amenities by exempting street frontages occupied by public open space meeting the criteria for bonused open space amenities from street-level development standards that might otherwise be in conflict.

DT-UDP11 Regulate uses at street-level in certain areas in order to generate pedestrian interest and activity in conformance with policies for the pedestrian environment. Promote street-level uses to reinforce existing retail concentrations, enhance main pedestrian links between areas, and generate new pedestrian activity where appropriate to meet area objectives without diluting existing concentrations of retail activity.

Promote active and accessible uses at the street-level of new development where it is important to maintain the continuity of retail activity.

Consider measures to promote street-level space of adequate size and sufficient flexibility to accommodate a variety of retail and service activities. Encourage incorporation, as appropriate, of street-level uses as part of open space public amenity features provided for a floor area bonus to promote activity and increase public use of these spaces.

To encourage active and accessible street-level uses throughout Downtown, consider appropriate exemptions of these uses from floor area limits.

DT-UDP12 Regulate signs to:

1. allow adequate identification of businesses and allow businesses to advertise their products;
2. add interest to the street-level environment;
3. protect public safety;
4. reduce visual clutter; and
5. enhance the appearance and safety of the Downtown area.

Generally discourage signs not oriented to people at street-level. Limit signs on roofs and the upper floors of buildings, intended primarily to be seen from a distance.

Continue the present policy of restricting the issuance of permits for new billboards, including that existing billboards may be maintained and repaired, but not expanded or structurally altered.

Subject signage within the Pioneer Square Preservation District, International Special Review District, and the Pike Place Market Historical District to the regulations and approval of the appropriate boards or commissions.

DT-UDP13 Further promote the urban design and development objectives of these policies through the City's design review process to ensure that Downtown development is orderly, predictable, and aesthetically pleasing.

OPEN SPACE POLICIES

DT-OSP1 Expand Downtown open space as a comprehensive network to:

1. promote an orderly, visually pleasing, and active environment for workers, residents, and visitors;
2. reinforce desired land use patterns;
3. provide links among areas within and surrounding Downtown; and
4. improve pedestrian circulation.

Expand the open space system through:

1. development of new parks and/or other open space
2. adaptation of streets not critical to vehicular circulation to increase right-of-way use for pedestrian circulation;
3. incorporation of open space, as appropriate, in major public projects;
4. a system of incentives to promote development of public open space as part of new Downtown projects through bonuses for private development of



public open space and/or transfer of development rights from sites providing public open space; and

5. encouragement of amenities to enliven open spaces.

DT-OSP2 Support the addition of major new public open spaces to the Downtown open space network to meet the needs of Downtown's growing employment and residential populations. Promote new open space development consistent with the Comprehensive Plan's open space goals and adopted policies of Downtown neighborhood plans. Open space projects to be considered for potential development in the future include the following:

1. **Harborfront Open Space.** To improve public access and enjoyment of the shoreline, and to better integrate east-west pedestrian connections between the Harborfront promenade and the rest of Downtown by developing open space where appropriate opportunities exist along the waterfront.
2. **Westlake Circle.** To provide a formal Downtown terminus of Westlake Avenue and complement the special character desired for this potential boulevard; and to better integrate the retail core with the Denny Triangle neighborhood, by locating public open space in the area bounded by Stewart Street, Olive Way, and Fifth and Sixth Avenues.
3. **International District Community Gardens.** To perpetuate the existing use of the Community Gardens on the Chinatown/International District hilltop by providing public access and supporting the completion of property acquisition for the gardens.

DT-OSP3 Consider major public projects, such as the City Hall and convention center, as opportunities for adding significant public open space Downtown. Consider including public open space in these projects when it is consistent with their function and integrate new open space with surrounding parks and public spaces, as appropriate. Any redevelopment of the existing Convention Place transit station site should include a public open space component.

DT-OSP4 Accommodate active and passive pedestrian space on portions of existing street rights-of-way designated as green streets in accordance with the Pedestrian Classification Policy (Policy T10) and maps adopted by ordinance. Classify the various street segments comprising a green street according to desired vehicle circulation characteristics. In residential areas, generally develop green streets to reinforce neighborhood character. Encourage neighborhood commercial activities at appropriate locations along green streets to enliven the space with outdoor cafes, stalls, and displays to the extent consistent with the basic transportation use of the right-of-way. In office and mixed-use areas, improve green streets to provide a focus for new development and add open space for the enjoyment of workers, residents, and shoppers. Encourage interesting street-level uses and pedestrian amenities to enliven the green street space and lend a special identity to the surrounding area.

Establish procedures to address some issues related to the development of green streets, such as development of general design standards, approval mechanisms, and maintenance agreements to coordinate green street implementation with adjacent private development. Establish a design process to guide development of specific design plans for each green street.



DT-OSP5 Open Space Amenity Features. In zones with a base and maximum FAR, consider allowing increases in density above the base FAR to encourage development of public open space to meet the open space needs of higher density development and help achieve Downtown open space goals. Consider, when appropriate, including conditions requiring dedication of such space in perpetuity. Coordinate the various incentives for providing open space to promote an equitable distribution of open space resources among Downtown neighborhoods and to prioritize development of open space in areas with the greatest need, consistent with the open space goals for Downtown in the Comprehensive Plan. Include the following as possible options for providing open space features to gain additional floor area:

1. **On-site Public Open Space.** Allow additional floor area for a variety of outdoor and interior features provided on a project site for public use. Such amenities should be highly visible and easily accessible to the public from the street; be of appropriate design and adequate size to function as usable space; be enlivened by uses and other features, including public art, that attract activity; and be designed and sited to respond to the surrounding context and maximize public use.
2. **Off-site Public Open Space.** Consider allowing office developers to provide required open space as public open space not located on their project sites to gain floor area above the base FAR. In addition to features similar to the on-site public amenities described above, other off-site features could include:

Green Street Improvement. Encourage private participation in the development of designated green streets as new projects are built by allowing increases in floor area above the base FAR for cash contributions or construction of green street improvements in accordance with green street plans.

DT-OSP6 Consider allowing the transfer of development rights from sites identified as desirable and appropriate locations for public open space. Include as conditions of the transfer that the sending site or open-space portion of the site be improved for public use as open space and dedicated in perpetuity to that use. Coordinate the various incentives for providing open space, including open space TDR, to promote an equitable distribution of open space resources among Downtown neighborhoods and to prioritize development of open space in areas with the greatest need, consistent with the open space goals for Downtown in the Comprehensive Plan.

DT-OSP7 Generally require major residential and office developments in Downtown to provide open space and/or recreation space adequate to meet the needs of project occupants and to offset the demands that high-density developments place on existing open space resources. As appropriate, provide incentives to encourage project developers to meet this requirement by providing open space accessible to the public, either on the project site or at a nearby location.

Consider extending open space requirements to other uses upon finding that these uses generate demands for open space.



ECONOMIC DEVELOPMENT POLICIES

DT-EP1 Promote development consistent with this plan. Consider the impact on economic development in the planning of major public projects and consider public actions to facilitate private development. Where possible, encourage private sector cooperation in implementing actions such as training and employment for target population groups.

DT-EP2 Seek to expand employment, training, and placement opportunities for Seattle residents with the objectives of:

1. expanding opportunities to target employment population;
2. providing a mechanism for the coordination and funding of training and referral programs; and
3. encouraging public/private partnerships in employment and training.

HOUSING POLICIES

DT-HP1 Address the desired balance of housing affordable to the full range of household income levels through a collaborative effort between the City and Downtown neighborhoods. Seek to achieve the Downtown Urban Center housing growth target and goals for the number and affordability of Downtown housing units in the adopted policies of the Downtown neighborhood plans.

Balance adopted neighborhood plan goals to achieve overall housing goals for Downtown. Consider these goals as the City develops and implements housing programs and as City funds and other public resources are distributed. Promote the maintenance and preservation of housing affordable to low- and low-moderate income households.

DT-HP2 To strive to achieve an adequate balance in employment and housing activity and to meet Downtown housing goals, promote public and private actions for developing a significant supply of affordable Downtown housing to help meet demand generated by Downtown employment growth.

Public/Private Partnerships. Work with Downtown neighborhoods, businesses, and public and nonprofit organizations to meet Downtown housing goals, especially with regard to implementing programs to develop and maintain affordable Downtown housing units.

Light Rail Station Area Development. Review all light rail station area development plans to identify opportunities for high-density transportation efficient housing in these areas and to address potential impacts on existing housing resources.

DT-HP3 Address the demand for housing generated by Downtown growth that is not being met by the private market, and help offset the pressure of Downtown growth on existing affordable housing resources, through provisions to encourage the development of affordable housing, especially for households with incomes between 0 percent and 80 percent of the median income for the region. To this end, within Downtown office, retail, mixed-use commercial, and mixed-use residential

areas with established base and maximum density limits, generally allow bonus floor area conditioned upon a voluntary agreement for the provision of lower-income housing or a payment to a fund for that purpose. To further Downtown housing goals, limit housing developed through the bonus program to areas permitting housing within the boundaries of the Downtown Urban Center, except that additional areas may be included if such an expansion of the program would be consistent with the goals of both the Downtown Urban Center Plan and the adopted policies of other relevant neighborhood plans. Density bonuses shall not be granted for any housing developed within the Pike Market Mixed zone, where other mechanisms are available to achieve the housing objectives of this land use district.

Require that housing provided for density bonuses serve a range of lower-income households, particularly those with incomes below 80 percent of median income, based on the estimated additional needs resulting from new commercial or residential development. Take into account, in determining the amount of housing to be provided, the value of the increased development potential in relation to the cost to the developer, and the extent to which use of bonus floor area is desirable in light of the City's planning goals. Review bonus provisions for housing periodically to consider changes in impacts on housing need, land prices, housing production costs, progress toward planning goals, and other factors.

DT-HP4 Promote the integration of Downtown residents of different income levels by encouraging new development that includes units affordable to households with a range of incomes, including low-income residents. Seek through the administration of funds available for new low-income housing to encourage projects with units affordable to households with a range of incomes, and consider additional incentives for promoting this type of development.

DT-HP5 Pursue the following strategies for maintaining existing Downtown housing resources:

Housing Transfer of Development Rights (TDR). Allow the transfer of unused development rights from structures providing at least a minimum amount of low-income housing, which may be mixed with low-moderate income housing and/or other uses, to sites located elsewhere in Downtown to provide an incentive for maintaining this housing resource. Condition the use of this mechanism to address issues such as the use of subsidies or tax benefits that may reduce or eliminate the need for preservation incentives, required rehabilitation, and compliance with housing and building codes, and the length of time the housing is to be maintained at specified affordability levels.

Preservation of Project-Based Section 8 Housing. Seek to promote preservation of federally-assisted housing units in Downtown Seattle that are at risk of conversion to market-rate rentals or other uses.

Minimum Housing Maintenance. To prevent the deterioration and abandonment of sound Downtown housing units, consider and evaluate alternatives for a minimum maintenance program including incentives to discourage the neglect of sound housing.

Publicly Supported Housing Programs. Aggressively seek funds and target programs as appropriate to rehabilitate existing structures, construct new low- and low-moderate-income units, and provide rent subsidies. Review annually public housing

resources and the findings of the housing monitoring program and programs targeted to the most cost-effective actions to achieve goals for the number of low-income units to be provided by the year 2014.

DT-HP6 When proposed major projects funded by government agencies have an impact on low-income housing, consider, when appropriate, measures to mitigate that impact.

DT-HP7 In addition to providing for housing, pursue strategies to enhance the livability of Downtown for existing residents and to provide a high-quality neighborhood environment to attract future residents, including encouraging, as appropriate, the location of public school facilities within or easily accessible to Downtown.

HUMAN SERVICES POLICIES

DT-HS1 Address the demand for child care services generated by Downtown employment growth by including in the conditions for achieving bonus floor area the provision of child care facilities on project sites, or payment to a fund for providing child care facilities at appropriate locations within Downtown.

Child care facilities provided as part of the conditions for bonus floor area must serve a percentage of lower-income families on a free or reduced-fee basis, in order to address the needs of lower-paid employees in Downtown buildings.

Portions of public open space provided for a floor area bonus may be restricted to satisfy requirements for outdoor space associated with child care centers.

DT-HSP2 Support human services to meet the needs of Downtown workers and residents through direct public action and consider incentives to encourage developers to include these uses in new private development.

Seek to maintain and expand human services for the Downtown low-income population through public actions and the encouragement of private participation, recognizing the relationship between low-income housing needs and human services. Promote collaboration between the City and the community to address human services issues.

To enhance the mix of activity within Downtown and accommodate human service needs, encourage private development to include provision for human services, including such uses as shelter housing, by, for example, exempting appropriate human service uses from chargeable floor area and by providing assistance for specific projects.

DT-HSP3 Maintain a Downtown Human Services Fund to provide services to meet the needs of low-income residents and workers.

DT-HSP4 Strive to maintain the provision of human services for low-income Downtown residents and workers as a high priority for the use of federal and state funds received by the City for health and human services programs.

DT-HSP5 Consider the needs of target populations in locating human service facilities throughout Downtown. Administer funds available for human services to insure coordination of housing and human services needs of the Downtown low-income

population. Seek to avoid over-concentration of human service facilities in any one area of Downtown, and encourage the location of needed facilities in areas lacking such facilities.

TRANSPORTATION POLICIES

DT-TP1 Recognize the critical role that high-capacity transit corridors play, including the transit tunnel, in supporting the distribution of development density and the movement of goods and people within and through Downtown. Seek to improve the system, through actions by the City, with Sound Transit and King County Metro Transit, and other transit agencies that:

1. provide capacity to meet forecast transit growth;
2. reduce travel time by transit;
3. reduce transit rider crowding on sidewalks;
4. reduce diesel bus noise and odor; and
5. provide an attractive and pleasant street environment for the pedestrian and transit rider.

DT-TP2 Improve and expand the street-level elements of the regional transit system to provide the primary mode of vehicular travel among Downtown activities. Integrate the system with the transit tunnel, the pedestrian circulation network, peripheral parking facilities, and other modes of travel to Downtown including the ferry system, intercity bus, and intercity rail.

Base Circulation System. Promote a base circulation system including modifications to existing service and additional Downtown routes to improve access within Downtown and between Downtown and adjacent neighborhoods. In considering improvements to the base circulation system, examine the potential for using the Monorail, waterfront streetcar, shuttles, and regional bus service to enhance the base circulation system and improve local service.

Long-range System and Incentives Agreement. Seek a long-range program of transit circulation improvements, together with an incentives agreement defining the appropriate mechanisms for increasing service to be developed among the King County Department of Transportation Transit Division, Sound Transit, and the City.

DT-TP3 Strive to retain a ride-free zone and consider possible future expansion based on transit demand, finances, and operational conditions.

DT-TP4 Promote the efficiency of the regional highway system and major arterials within Downtown for vehicular access and circulation. Discourage through-traffic within Downtown's residential and shopping areas as well as those surrounding Downtown. Facilitate the smooth flow of peak-hour traffic on Downtown streets providing access to the regional highway network.

Support projects intended to improve access to and local circulation within Downtown, taking into account other Downtown goals and policies.

DT-TP5 Promote pedestrian circulation as the principal method of movement for trips within Downtown. Improve the street-level environment as the primary component of the pedestrian network. Strive to make the pedestrian network accessible to the elderly and disabled.

Continue to support a comprehensive program of public improvements to streets and sidewalks in coordination with the transportation, open space, land use, and urban design policies. Consider the following pedestrian circulation improvement projects:

1. **Downtown Transit Corridor** (streets above the Transit Tunnel). Surface pedestrian improvements to improve access to transit stations as part of planning for transit station area development.
2. **Spot Improvements.** A program of location- specific pedestrian improvements at major bus stops and high volume pedestrian locations.
3. **Green streets.** Design and development of designated green streets in Downtown neighborhoods for added passive and active pedestrian space in accordance with the adopted policies of neighborhood plans, the green street policies, and these policies.
4. **Belltown Boulevard.** Development of a landscaped transit/pedestrian boulevard with widened sidewalks along Third Avenue through Belltown as an extension of the Downtown Transit Corridor.
5. **Westlake Boulevard.** Development of a landscaped boulevard with widened sidewalks along Westlake Avenue between Olive Way and Denny Way, consistent with the Belltown, Denny Triangle, and Commercial Core neighborhood plans. Coordinate potential extension to South Lake Union with neighborhood planning for that area.
6. **Waterfront Linkages.** Improvements to east-west pedestrian connections and access through Downtown and between Downtown and the waterfront, including additional hill-climb opportunities as part of both public and private projects.
7. **Linkages across I-5.** Look for opportunities to re-establish connections between Downtown and adjacent areas by enlarging existing crossings, creating crossings under, or constructing lids over I-5 that can also provide opportunities for development or open space.

DT-TP6 Seek to accommodate increased pedestrian volumes resulting from more intensive development, improve pedestrian circulation, and enhance the Downtown pedestrian environment, by considering conditioning certain development on, or requiring new development to provide, the following features:

1. **Sidewalk Widening.** Minimum sidewalk width requirements in high-volume pedestrian areas. Consider requiring the street-level of buildings to be set back from the street property line, in order to provide pedestrian space to accommodate additional pedestrian trips and transit activity associated with higher density development, and to enable properties in such areas to benefit reciprocally from the pedestrian traffic and transit activity. Vary the



sidewalk width requirements according to the transportation function and anticipated volume of pedestrian traffic of the street, as indicated by the street classification system established in Policy T10.

2. **Overhead Weather Protection.** Overhead weather protection covering portions of the sidewalk along active, high-volume pedestrian streets in order to enhance pedestrian comfort and to enable properties to gain reciprocal benefits from encouraging pedestrian activity. Overhead weather protection may include nonstructural features like canopies, awnings, and marquees or structural features like building overhangs and arcades.

DT-TP7 To encourage improvements that enhance pedestrian circulation and increase pedestrian comfort, consider floor area bonuses for the following features provided in specified locations:

1. **Hillclimb Assist.** To assist pedestrian movement up and down steeply sloping sites between parallel avenues by providing pedestrian corridors that incorporate mechanical features such as elevators or escalators.
2. **Shopping Corridor.** To enhance pedestrian circulation and promote the concentration of shopping activity in the retail core and adjacent areas where pedestrian volumes are highest by providing through-block passages lined with shops connecting parallel avenues.
3. **Transit Station Access.** To integrate the pedestrian network with the transit tunnel system and to minimize sidewalk conflicts in office and retail areas on sites near transit stations by improving access to the system.

Base approval of the bonus on special evaluation criteria to ensure that the location and design of the transit station access is well integrated with the transit system and street-level pedestrian network. Bonus eligibility of particular features may be discontinued if the City finds that the need for additional such features has declined in relation to other Downtown priorities.

DT-TP8 Discourage pedestrian grade separations, whether by skybridge, aerial tram, or tunnel, to maintain an active pedestrian environment at street-level.

DT-TP9 Encourage and enhance bicycle access to and within Downtown. Allow bicycles to use all Downtown streets. Establish routes or corridors to connect Downtown with the citywide network of bicycle routes. Provide bicycle storage facilities in major new public and private development. Within bicycle corridors, study specific improvements, including signing or actions to increase bicycle safety.

Explore opportunities to create dedicated bicycle facilities on streets within Downtown.

DT-TP10 Classify Downtown's streets according to the desired functional relationships of the various uses of the right-of-way. Through this classification system, integrate multiple vehicular and pedestrian needs, minimize modal conflicts, reflect, and seek to do the following: reinforce adjacent land use, and provide a basis for physical changes and improvements. Use this system as a guide to identify and prioritize capital improvements and operating changes.



Classify Downtown streets under categories addressing three primary functions:

1. traffic function,
2. transit function, and
3. pedestrian function.

Traffic Classification. Classify Downtown streets according to the arterial street classifications of the Seattle Comprehensive Transportation Program (SCTP). The primary intent of this system is to promote vehicular use of streets that is consistent with Policy T4: Vehicular Access and Circulation Improvements.

Transit Classification. Classify Downtown streets according to the transit street classifications of the SCTP. Use these classifications to coordinate improvements to the street right-of-way and abutting development so that high volumes of buses occur on streets with adequate sidewalk space for waiting riders.

Pedestrian Classification. Establish pedestrian classifications for all Downtown streets. The primary intent of this classification system is to coordinate improvements to the street right-of-way and abutting development to comfortably and safely accommodate anticipated pedestrian volumes and reinforce desired conditions for pedestrian circulation consistent with the Urban Design policies. Designate each Downtown street according to the following categories and functions:

- **Class I:** High-volume pedestrian activity street providing a major link in Downtown pedestrian circulation.
- **Class II:** Moderate pedestrian activity street providing a secondary link in the pedestrian circulation system.
- **Green Street⁹** Link in pedestrian circulation system and element of open space bonus system.

DT-TP11 Limit the size and location of curb cuts providing vehicular access to abutting property in order to minimize conflicts with other uses of the street right-of-way, particularly pedestrian and transit activity. Use the Street Classification System to guide the number, size, and location of curb cuts. Place the greatest emphasis for minimizing curb cuts on Class I Pedestrian Streets and Principal Transit Streets because of their importance to Downtown pedestrian circulation, with access from alleys and Class II Pedestrian Streets generally preferred. Generally, discourage access from green streets, with curb cut controls evaluated on a case-by-case basis during the planning of individual green streets. Standards for the location and size of curb cuts may be modified to accommodate steep slopes or other special conditions, taking into consideration pedestrian safety and the smooth flow of traffic.

DT-TP12 Through a variety of actions, seek to provide an adequate supply of parking to meet forecast needs, balanced with incentives to encourage the use of transit, vanpools, carpools, and bicycles as alternatives to commuting by auto. In this balancing, generally maintain tighter restrictions on parking serving low-occupancy

auto commuters who add to peak period traffic congestion, while allowing more flexibility for parking associated with trips for non-peak activities, such as shopping.

- DT-TP13** Maintain maximum parking requirements to restrict the supply of available long-term parking and to encourage use of alternatives to commuting by auto. Favor short-term parking to meet shopper and visitor needs over long-term parking. Exempt residential use from parking requirements within Downtown where residents can walk or have convenient transit access to work and services, in order to promote affordable housing and reduce auto dependency.
- DT-TP14** Exempt floor area occupied by short-term parking from the calculation of permitted floor area to recognize the difference in impacts between short-term parking and other kinds of uses and to provide an incentive for projects to include short-term parking to meet shopper and visitor parking needs. Short-term parking means parking that is marketed, priced, or operated in a manner that encourages its use as parking for shoppers and other non-commuters.
- DT-TP15** Generally require new development to provide off-street loading spaces to accommodate building service and delivery needs without disrupting traffic and street-level pedestrian activity.
- DT-TP16** To ensure consistency with overall land use and transportation policies for Downtown, limit development of parking as the principal use on a lot, as described below:
1. **Short-Term Parking Garages.** To facilitate shopping and access to personal services, allow short-term parking garages in all areas except residential districts and the waterfront west of Alaskan Way, unless specified otherwise pursuant to adopted neighborhood plan policies.
 2. **Long-Term Parking Garages.** In determining to what extent to allow garages for long-term parking, consider the following potential impacts: congestion; negative impacts on adjacent pedestrian and land use activities; encouragement of travel in single occupant vehicles; and conflicts with transportation management programs established to reduce such travel.
 3. **Permanent Surface Parking Lots.** Prohibit permanent surface parking lots in most areas to avoid disruption of the pedestrian environment at street-level, maintain the level of activity and intensity of development desired Downtown, and discourage single-occupant vehicle travel. Identify areas where the impacts associated with permanent surface parking lots may be mitigated and consider permitting them in such areas, subject to mitigating conditions.
 4. **Interim Surface Parking Lots.** Where permanent surface parking lots are prohibited, consider allowing interim surface parking lots for a restricted time period when the property would otherwise be unused pending redevelopment, in office, retail, and mixed commercial areas, excluding Special Review Districts.
 5. **Principal-Use Parking Garages.** To support residential development, consider allowing principal use parking garages in residential districts where such facilities are compatible with the desired neighborhood character.



DT-TP17 Consider use of a Downtown parking fund to facilitate the construction of parking facilities supporting Downtown land use and transportation policies and recognized neighborhood plans, at locations consistent with the policies of this plan. Potential fund sources include contributions in lieu of constructing required accessory parking on site, revenues from existing and future public parking facilities, property or business assessment districts formed to construct Downtown parking, and proceeds from the sale of revenue bonds or other bonds for parking construction.

Downtown Neighborhood (Urban Center Village)

Belletown

HOUSING GOALS

- B-G1** A neighborhood where growth provides a varied housing stock and a wide range of affordability.
- B-G2** A neighborhood with tools to preserve its housing stock and prevent displacement of low- and low-moderate-income residents.

HOUSING POLICIES

- B-P1** Seek to assist nonprofit developers to develop new affordable housing in the neighborhood.
- B-P2** Seek to preserve the existing neighborhood scale and character by developing tools that both encourage the retention of existing buildings and encourage the creation of a variety of new small-scale buildings.
- B-P3** Develop methods to integrate and stabilize the current population, respect neighborhood character, and serve as a catalyst for the rest of the planning objective.
- B-P4** Support the neighborhood's identified goals for housing affordability.
- B-P5** Support projects that will increase artist housing.
- B-P6** Strive to increase the amount of housing production achieved through the Bonus and Transfer of Development Rights Program.
- B-P7** Strive to preserve the existing housing stock, including older buildings, subsidized units, and affordable, unsubsidized units.



- B-P8** Improve and use a variety of tools to create and preserve affordable housing, such as increased funding and regulatory mechanisms (e.g., the land use code affordable housing requirement, and Transfer of Development Rights (TDR) and Bonus programs).
- B-P9** Develop tools for owners of existing affordable rental housing to make property improvements at low cost, in order to minimize increases in rents.
- B-P10** Strive to maintain the affordability of existing federally subsidized housing.
- B-P11** Strive to establish and maintain ongoing monitoring of housing affordability as the market changes over time.
- B-P12** Promote voluntary first-right-of-refusal agreements between local property owners and tenants, through means such as developing programs to assist nonprofit agencies to identify willing property owners.
- B-P13** Research and report to the community on housing issues related to specific sites where neighborhood input is appropriate.

LAND USE GOALS

- B-G3** A neighborhood with a vibrant streetscape.
- B-G4** A neighborhood with a mixed-use character with an emphasis on residential and small business activity.
- B-G5** A Belltown with neighborhood design guidelines and design review.

LAND USE POLICIES

- B-P14** Promote pedestrian activity through such methods as eliminating “dead spots” of street-level activity.
- B-P15** Provide opportunities for artists and start-up businesses through techniques such as live-work space and the temporary use of vacant “transitional” buildings.
- B-P16** Promote human-scaled architecture, particularly ground-level retail uses.
- B-P17** Increase neighborhood involvement in design review and development review.
- B-P18** Strive to preserve and enhance the intended residential character of Belltown by limiting the amount of off-site commercial advertising in the neighborhood.
- B-P19** Maintain designated view corridors.
- B-P20** Develop public/private investment strategies for a healthy business climate that attracts and supports the type of neighborhood businesses and other development desired to meet growth targets, provide jobs for residents, and to attract visitors for a healthy business climate.

BELLTOWN
Part of the Downtown Urban Center

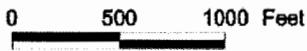
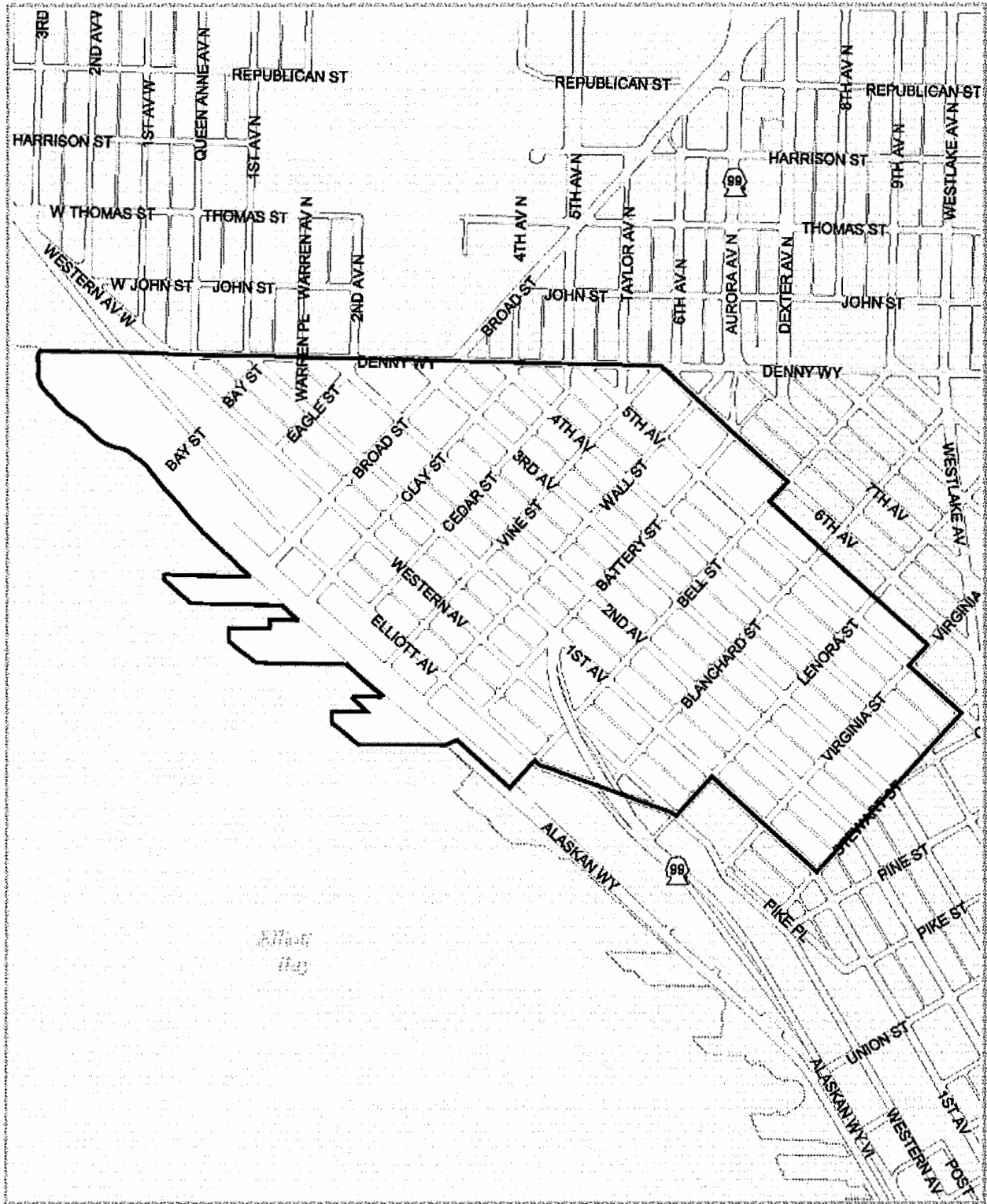

— VILLAGE BOUNDARY
— EDGE OF PAVEMENT

B-P21 Promote opportunities for small businesses to find affordable sites within Belltown.

TRANSPORTATION GOAL

B-G6 A circulation system that enables people to live, work, shop, and play in Belltown and all of Downtown without a car.

TRANSPORTATION POLICIES

B-P21 Accommodate vehicular access, egress, and parking that support residences, businesses, institutions, and destinations within Belltown.

B-P22 Manage routing and growth of vehicular traffic to minimize use of Belltown as a through-corridor and to mitigate neighborhood impacts.

PEDESTRIAN ENVIRONMENT GOALS

B-G7 A neighborhood with continued pedestrian and bicycle access to the waterfront and Myrtle Edwards Park, including at-grade access.

B-G8 A neighborhood with a sense of seamless transition between public and private space, and a sense of ownership of public spaces.

PEDESTRIAN ENVIRONMENT POLICY

B-P23 Encourage citizens to view streets as front porches, alleys as back doors, and parks (both public and private) as yards and gardens.

TRANSIT GOAL

B-G9 A neighborhood served by an efficient and easy-to-use transit system.

TRANSIT POLICIES

B-P24 Explore methods to consolidate transit service into major corridors within the neighborhood.

B-P25 Seek to develop well-designed and managed multimodal hubs in the neighborhood.

B-P26 Seek to improve transit access to other neighborhoods, especially to Capitol Hill and the University District.

PARKING GOAL

- B-G10** A neighborhood with sufficient parking to meet the needs of Belltown residents and the customers of businesses, and where the provision of adequate parking does not encourage people to choose car trips over other modes.

PARKING POLICY

- B-P27** Strive to establish and maintain adequate levels of parking in the neighborhood for residents and the customers of businesses while enhancing street-level activities and aesthetics.

ALLEYS GOAL

- B-G11** A neighborhood with alleys that are viable pedestrian and bicycle routes and business access points, and maintain their function for service access.

ALLEYS POLICIES

- B-P28** Promote well used, safe and clean alleys.
- B-P29** Promote the use and sense of ownership of alleys through the consideration of tools such as naming alleys and allowing the numbering of business and residences whose entries face alleys.

GREEN STREETS GOALS

- B-G12** A neighborhood with well-designed and constructed green street improvements on designated green streets.
- B-G13** A neighborhood with well-designed streetscapes that enhance the character and function of Belltown's streets and avenues.

GREEN STREETS POLICY

- B-P30** Encourage the use of the Belltown Streetscape Guidebook and Green Street Guidelines when designing street and sidewalk improvements.

COMMUNITY ENRICHMENT & SOCIAL SERVICES GOALS

- B-G14** A thriving, integrated community that takes a stewardship role in the community.
- B-G15** A neighborhood with a neighborhood center that provides facilities and services for neighborhood residents.

COMMUNITY ENRICHMENT & SOCIAL SERVICES POLICY

- B-P31** Encourage increased communication between social service providers and the community at large.

PUBLIC SAFETY AND NEIGHBORLY REGULATIONS GOAL

- B-G16** A neighborhood where it is safe to live, work, and play.

PUBLIC SAFETY AND NEIGHBORLY REGULATIONS POLICIES

- B-P32** Strive to increase participation in the Belltown Crime Prevention Council and Block Watch Programs through outreach.
- B-P33** Promote awareness of Crime Prevention Through Environmental Design (CPTED) techniques.
- B-P34** Promote a safe neighborhood environment to encourage day/night and weekend pedestrian-oriented activity.

Chinatown/International District

CULTURAL & ECONOMIC VITALITY GOAL

- ID-G1** Thriving businesses, organizations, and cultural institutions.

CULTURAL & ECONOMIC VITALITY POLICIES

- ID-P1** Support marketing activities that promote neighborhood businesses, events, and cultural opportunities.
- ID-P2** Work with the Chinatown/International District community to develop business improvement strategies to encourage greater customer patronage of individual businesses.
- ID-P3** Encourage new business development and location within the neighborhood.
- ID-P4** Emphasize nighttime activity to tap into a new market for businesses.
- ID-P5** Support development of a multipurpose community recreation center with space for community programs and associations.
- ID-P6** Improve utility infrastructure, when appropriate, to support community needs.



HOUSING DIVERSITY & AFFORDABILITY GOAL

ID-G2 A neighborhood with diverse and affordable housing.

HOUSING DIVERSITY & AFFORDABILITY POLICIES

- ID-P7** Seek to diversify housing stock to include more moderate-income and family housing.
- ID-P8** Seek additional affordable housing strategies to preserve existing low-income units and households.
- ID-P9** Explore resources and strategies for upgrading existing substandard and vacant buildings.

SAFE & DYNAMIC PUBLIC SPACES GOAL

ID-G3 Create safe and dynamic public spaces.

SAFE & DYNAMIC PUBLIC SPACES POLICIES

- ID-P10** Support specific programming to deliberately activate the parks, especially Kobe Park.
- ID-P11** Look for ways to incorporate design elements for crime prevention throughout the neighborhood, especially in parks, parking facilities, and alleyways.
- ID-P12** Increase pedestrian safety by adding additional stop signs and crosswalk striping, where appropriate.
- ID-P13** Build on partnerships that can work together to provide additional pedestrian amenities such as pedestrian street lighting, street trees, street furniture, and informational kiosks that enhance the pedestrian environment.
- ID-P14** Target Jackson Street, Dearborn Street, and Fifth Avenue for pedestrian improvements.

ACCESSIBILITY GOAL

ID-G4 An accessible neighborhood, with access within and to the neighborhood, for all transportation modes, while encouraging less dependence on cars and greater use of transit, bikes, and walking.

ACCESSIBILITY POLICIES

ID-P15 Seek to reduce auto congestion at key intersections.

CHINATOWN/INTERNATIONAL DISTRICT Part of the Downtown Urban Center

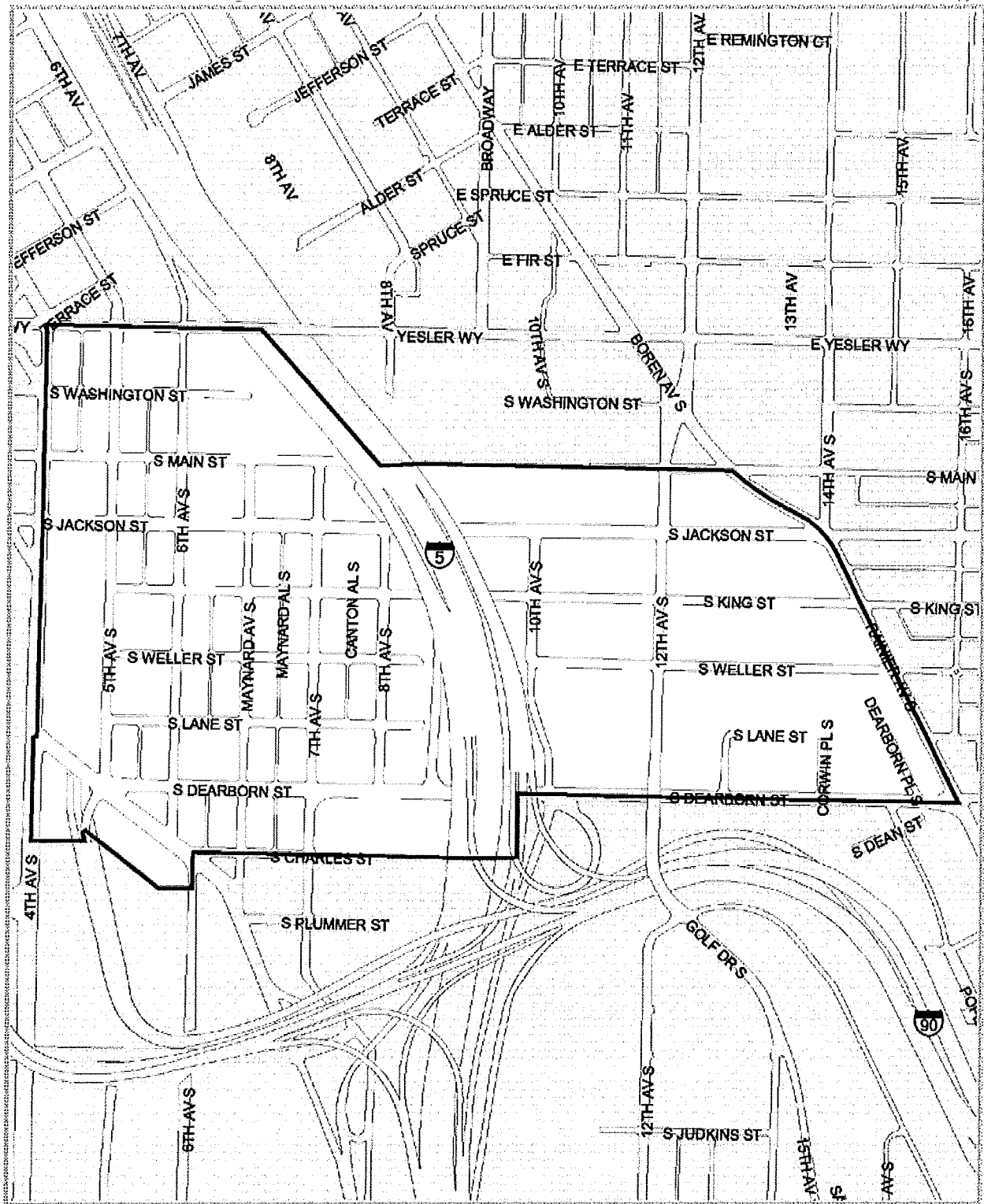

0 500 1000 Feet

— VILLAGE BOUNDARY
- - - EDGE OF PAVEMENT

- ID-P16** Work with Metro and Sound Transit to find ways to maximize service to residents, customers, and employees in the neighborhood.
- ID-P17** Improve bicycle route markings and related bicycle facilities, including bicycle racks within the neighborhood.
- ID-P18** Increase short-term parking opportunities within the neighborhood.

Commercial Core

GOALS

- COM-G1** Maintain the Commercial Core as a major employment center, tourist and convention attraction, shopping magnet, residential neighborhood, and regional hub of cultural and entertainment activities.
- COM-G2** Promote a unique neighborhood identity for the Commercial Core.

POLICIES

- COM-P1** Explore revising public benefit bonuses and incentive programs regulated by the Land Use Code to stimulate desirable development and support neighborhood goals.
- COM-P2** Encourage variety in architectural character and building scale.
- COM-P3** Strive to maintain the neighborhood's historic, cultural, and visual resources.
- COM-P4** Seek to provide housing affordable to households with a range of income levels.
- COM-P5** Guide development and capital projects throughout the entire Downtown area through development of a unified urban design strategy that provides a vision for new public facilities, waterfront connections, pedestrian environments, transit linkages, and open space.
- COM-P6** Strive to take advantage of opportunities to develop new public open space and encourage development of a system of connected green spaces and open public areas.
- COM-P7** Use green streets and open space as a means to improve urban design character and provide amenities that support growth.
- COM-P8** Seek to improve the cleanliness and safety of streets and public spaces.
- COM-P9** Seek to improve the pedestrian qualities of streets and public spaces.
- COM-P10** Seek to enhance pedestrian connections between the Commercial Core and other neighborhoods.



COMMERCIAL CORE
Part of the Downtown Urban Center

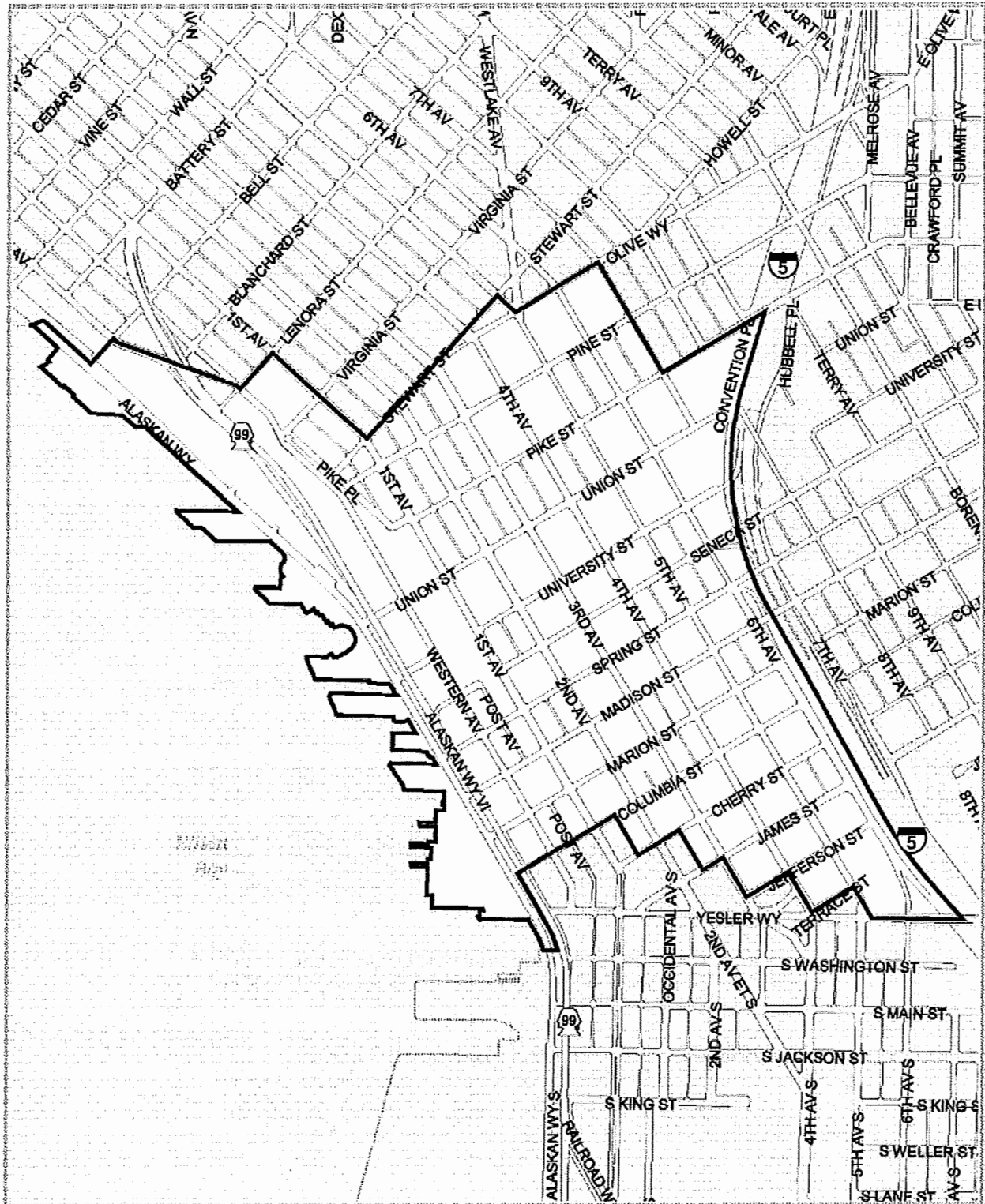

0 500 1000 Feet

— VILLAGE BOUNDARY
 - - - EDGE OF PAVEMENT

COM-P11 Work with transit providers to promote convenient transit and public access to and through the Commercial Core.

COMPP12 Seek opportunities to improve mobility throughout the Commercial Core.

COM-P13 Seek to increase coordination among Downtown human services providers.

Denny Triangle

HOUSING GOAL

DEN-G1 A diverse residential neighborhood with an even distribution of income levels.

HOUSING POLICIES

DEN-P1 Seek an even distribution of household income levels.

DEN-P2 Explore the use of bonuses, zoning, TDRs, and City investment to encourage housing throughout the Denny Triangle Neighborhood.

DEN-P3 Maintain a supply of low-income units in the Denny Triangle neighborhood throughout the life of the plan.

LAND USE GOAL

DEN-G2 A mixed-use neighborhood that combines commercial office space, retail sales and services, social and public services, and a residential population.

LAND USE POLICIES

DEN-P4 Consider a variety of land use tools, including increased height limits and floor area ratios, design review processes, bonuses for public benefit features, and exempting housing and retail space from floor area ratio, to stimulate both residential and commercial development.

DEN-P5 Encourage a mix of low-, moderate-, and market-rate affordable housing throughout the neighborhood, incorporated into projects that mix commercial and residential development within the same projects.

DEN-P6 Support creation of “residential enclaves” of predominantly residential development along key green street couplets at Ninth and Terry Avenues and Bell and Blanchard Streets identifiable as residential neighborhoods by small parks, improved streetscapes, retail functions, and transportation improvements that support neighborhood residents and employees alike.

URBAN FORM GOAL

DEN-G3 A diverse, mixed-use character that provides a transit- and pedestrian-friendly atmosphere.

URBAN FORM POLICIES

DEN-P7 Encourage the development of gateway markers at major entryways to the neighborhood along Denny Way.

DEN-P8 Encourage redevelopment of small triangular parcels as neighborhood gateways.

DEN-P9 Encourage the creation of new open spaces, including at Westlake Circle and at the Olive/Howell wedge.

DEN-P10 Encourage the creation of open space as part of new public projects.

DEN-P11 Support redevelopment of Westlake Boulevard as a boulevard.

DEN-P12 Designate and support the development of green streets in the neighborhood.

DEN-P13 Strive to accomplish goals for open space as defined for urban center villages, such as:

- One acre of Village Open Space per 1,000 households;
- All locations in the village must be within approximately one-eighth mile of Village Open Space;
- Dedicated open space must be at least 10,000 square feet in size, publicly accessible, and usable for recreation and social activities;
- There should be at least one usable open space of at least one acre in size where the existing and target households total 2,500 or more;
- One indoor, multiple-use recreation facility;
- One dedicated community garden for each 2,500 households in the village, with at least one dedicated garden site.

TRANSPORTATION GOAL

DEN-G4 Reduce external transportation impacts while improving internal access and circulation.

TRANSPORTATION POLICIES

DEN-P14 Encourage the integration of Westlake Avenue into the neighborhood physically, aesthetically, and operationally, while maintaining its arterial functions.



DENNY TRIANGLE

Part of the Downtown Urban Center

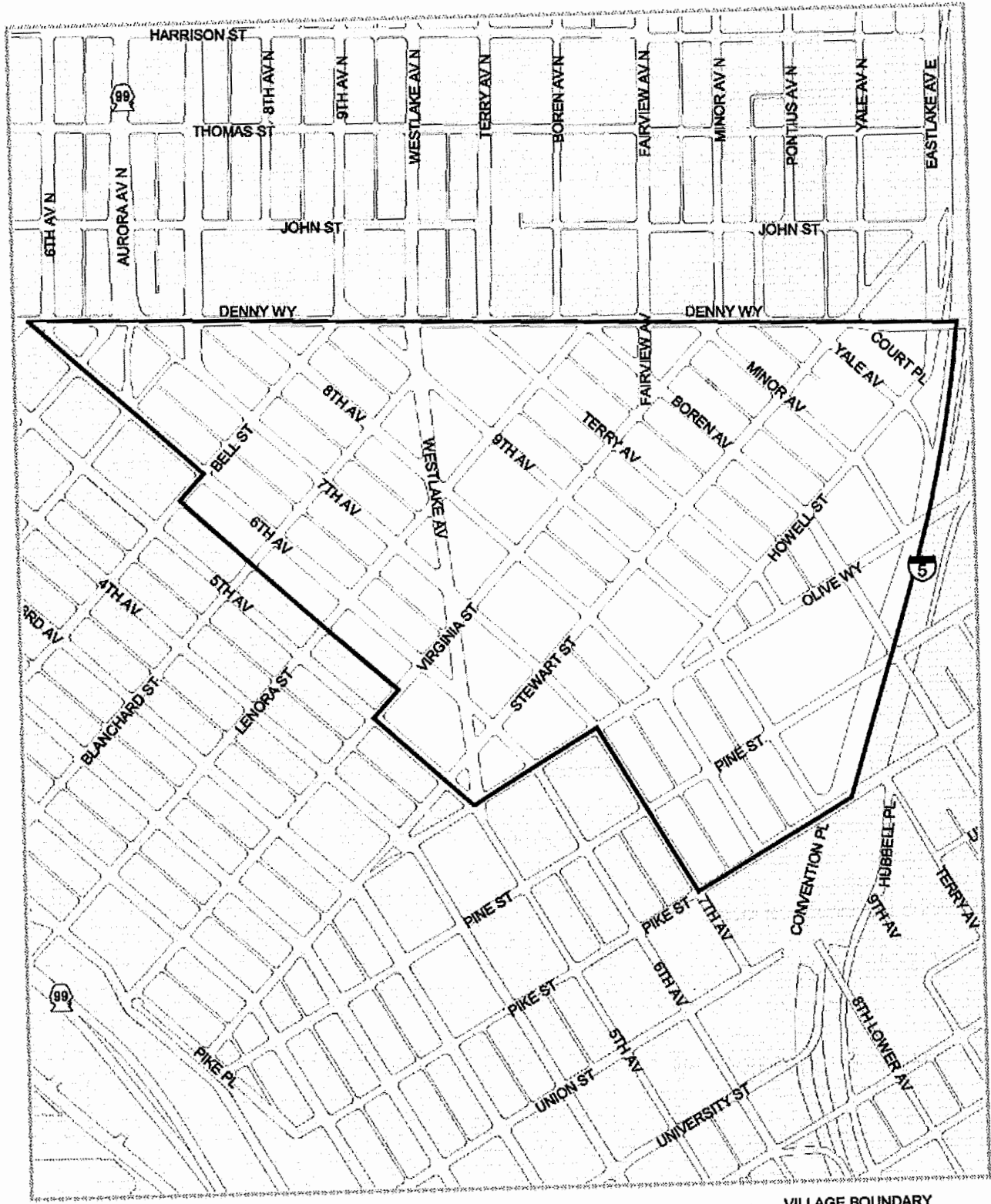

VILLAGE BOUNDARY
EDGE OF PAVEMENT



DEN-P15 Use partnerships with transit providers to improve the basic transit route structure, system access, and connectivity to better serve the neighborhood.

DEN-P16 Seek ways to improve safety and convenience of bicycle travel within and through the neighborhood.

DEN-P17 Explore ways to improve pedestrian safety and convenience along and across the arterials in the neighborhood.

DEN-P18 Consider development of traffic improvement plans to lessen the impact of regional automobile traffic on the Denny Triangle neighborhood.

Pioneer Square

OPEN SPACE GOAL

PS-G1 A community with a strong quality of life including public art and cleanliness.

OPEN SPACE POLICIES

PS-P1 Encourage the inclusion of an artist in the design of publicly funded projects.

PS-P2 Improve gardening, cleaning, and maintenance of public spaces within Pioneer Square through the coordination of city departments and private or nonprofit cleaning companies.

PS-P3 Recognize the importance of Occidental Corridor as the “center” of the neighborhood.

PS-P4 Strive to improve park areas within Pioneer Square through grant funding and technical assistance.

PS-P5 Reclaim Pioneer Square alleys for positive uses through improved cleanliness and safety programs.

PUBLIC SAFETY GOAL

PS-G2 A community that invites pedestrian and tourist activity through a high level of civil behavior and cleanliness.

PUBLIC SAFETY POLICIES

PS-P6 Raise and maintain a high level of public behavior and civility standards through police enforcement and participation by neighborhood groups.

- PS-P7** Continue to support Good Neighbor Agreements between existing social service providers and the neighborhood.

HOUSING GOAL

- PS-G3** A diverse community with a significant residential population.

HOUSING POLICIES

- PS-P8** Encourage housing development through both new construction and renovation of existing structures.
- PS-P9** Encourage the retention and development of artist live-work space.
- PS-P10** Encourage the development of incentive packages for housing construction and rehabilitation.
- PS-P11** Encourage the development of housing opportunities for a mix of incomes.
- PS-P12** Encourage concurrent development of businesses necessary to support residents in new housing developments.

ECONOMIC DEVELOPMENT GOAL

- PS-G4** A diverse and unique community with an eclectic mix of businesses and major community facilities.

ECONOMIC DEVELOPMENT POLICIES

- PS-P13** Recognize the Qwest Field North Lot development as a business anchor in the neighborhood.
- PS-P14** Encourage coordination between development projects, neighborhood enterprise, and the local labor pool—especially low-income and shelter residents.
- PS-P15** Strive to maintain local access to Pioneer Square during major events.
- PS-P16** Support neighborhood efforts to develop business support and communication system.

TRANSPORTATION & UTILITIES GOAL

- PS-G5** A community with an efficient transportation system that provides efficient access to sites inside and outside neighborhood boundaries.

PIONEER SQUARE
Part of the Downtown Urban Center

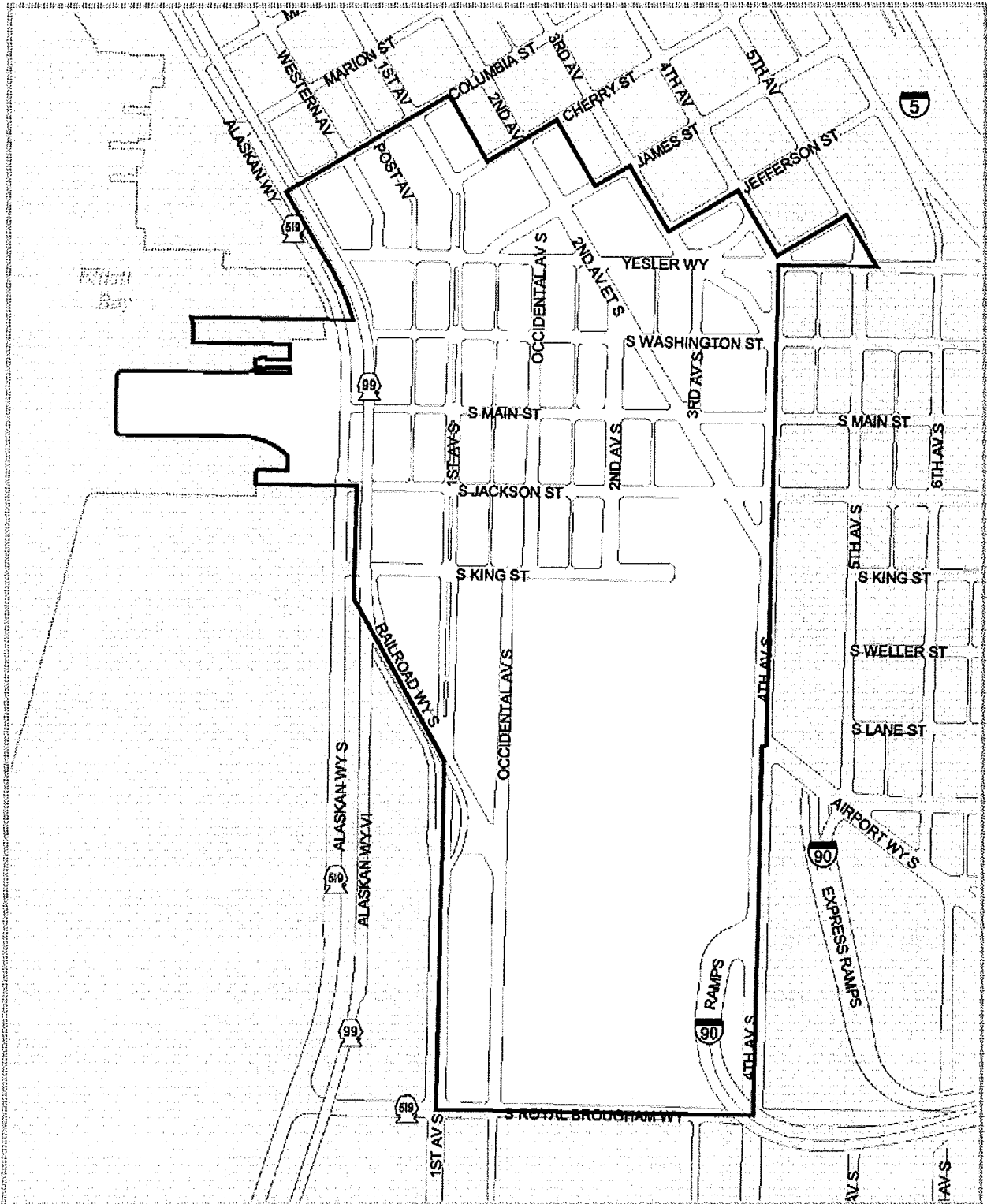

0 500 1000 Feet

— VILLAGE BOUNDARY
— EDGE OF PAVEMENT



TRANSPORTATION & UTILITIES POLICIES

- PS-P17** Coordinate with other responsible agencies to develop access opportunities to the neighborhood through transit and pedestrian methods.
- PS-P18** Strive to improve infrastructure to accommodate increased pedestrian and traffic uses.
- PS-P19** Strengthen coordination of alley improvements among city department and involved neighborhood groups.
- PS-P20** Encourage the development of a community-parking program in order to provide access for residents, especially during events.

Eastlake

COMMUNITY DESIGN GOALS

- EL-G1** A residential lakefront community primarily defined by low to moderate residential density, pedestrian-scale mixed-use development, neighborhood services, Lake Union maritime uses, and compatible architectural styles.
- EL-G2** A safe and interesting streetscape with pedestrian activity, a strengthened commercial identity and residential community, and reduced conflicts between residential and commercial uses along Eastlake Avenue East.
- EL-G3** A neighborhood that values and preserves its traditional diversity and scale of development, and that respects its ecology and environment.
- EL-G4** A community with pedestrian activity, and attractive close-in and distant views along streetscapes, alleys, and shorelines.
- EL-G5** A community where the residential growth is consistent with Eastlake's character, size, scale, infrastructure, and public services, and occurs in locations appropriate for residential uses.

COMMUNITY DESIGN POLICIES

- EL-P1** Encourage the consolidation of commercial and residential uses on Eastlake Avenue East into districts or nodes that would: strengthen the identity of each area; reduce the potential for conflicts between land uses; increase residential development along parts of Eastlake Avenue East; increase the development of neighborhood-serving businesses at street-level; and direct vehicle access and parking to alleys and side streets.
- EL-P2** Identify, preserve, enhance, and create a variety of attractive and interesting views from and of public spaces.

- EL-P3** Anticipate and minimize, through zoning regulations and/or design review guidelines, to be prepared for the Eastlake area, the potential for impacts on residential uses from the close proximity, orientation, or incongruent scale of commercial development, including the loss of privacy, sunlight, or air, or increased noise, artificial light, or glare.
- EL-P4** Seek opportunities to conserve Eastlake's older structures as defining elements of Eastlake's architectural and historic character and as a resource for affordable housing and commercial spaces.
- EL-P5** Through design review, promote interaction between the community, developer, designers, and decision-makers to help ensure buildings contribute to and enhance Eastlake's character.
- EL-P6** Explore the development of live-work units in areas that allow commercial development.
- EL-P7** Buildings are an important part of Eastlake's views and residential and commercial streetscapes, and their designs should reflect the neighborhood's lowrise, finely textured scale, comparatively small development sites, and the individuality of its architectural expressions.
- EL-P8** Pedestrian connections between buildings should occur at the street-level. Avoid skybridges on public property and rights-of-way in Eastlake; when connections across such public land and rights-of-way are necessary, pursue below-grade connections to buildings that do not detract from activity at the street-level, the streetscape, and public views.
- EL-P9** Promote interesting, safe, and diverse pedestrian connections that are compatible with and sensitively designed for abutting land uses.
- EL-P10** Strive to preserve, restore, and maintain Eastlake's historic cobblestone streets.
- EL-P11** Enhance Lynn Street between Eastlake and Boylston Avenues East as a gateway to the Eastlake neighborhood, a view corridor, and an important pedestrian connection without expanding its existing street or right-of-way width.
- EL-P12** Use and development of Eastlake's shoreline properties should strengthen and enhance the neighborhood's existing maritime uses, recreational uses, habitat, and floating home community through the future use and development of Eastlake's shoreline properties.
- EL-P13** Maintain, enhance, and nurture the Seward School as a public school, historic landmark, and focus of community identity and social, civic, and recreational activities.
- EL-P14** In the Eastlake Residential Urban Village, special L3 and L4 locational criteria for the evaluation of rezones to the L3 and L4 designations inside of urban villages shall not apply.



OPEN SPACE GOALS

- EL-G6** A neighborhood that cherishes and preserves its urban ecological health.
- EL-G7** An open space network providing a variety of experiences that promotes community, ecology, learning, and stewardship, and that serves Eastlake and the larger region for current and future generations.

OPEN SPACE POLICIES

- EL-P15** Encourage Eastlake residents, businesses, and public facilities to plant native vegetation on public and private properties.
- EL-P16** Encourage the use of landscaping, berms, and other natural sound-absorption techniques to reduce noise and create an aesthetically pleasing environment or wildlife habitat.
- EL-P17** Provide open space for wildlife and plant habitat, pedestrian connections, and passive and active recreation. For individual open space sites, identify the primary purpose from among these four purposes, plan for compatible uses, and discourage incompatible uses.
- EL-P18** Strive to create an attractive, identifiable gateway (“North Gateway”) to Eastlake and the adjoining neighborhoods that provides open space, art, and community identity.

TRANSPORTATION GOALS

- EL-G8** A neighborhood where seniors, children, and people with disabilities can stroll and cross streets safely, where bicyclists are safe, buses are frequent, and bus stops convenient, where truck access is good, and where through-traffic, freeway noise, and pollution are controlled.

TRANSPORTATION POLICIES

- EL-P19** Strive to improve pedestrian facilities including street crossings, sidewalks and other walkways, especially along Eastlake Avenue.
- EL-P20** Strive to establish additional pedestrian connections where they do not now exist, such as under or over Interstate 5 or along the shoreline.
- EL-P21** Strive to enhance Fairview Avenue East north of East Newton Street through traffic-calming and other pedestrian safety improvements.
- EL-P22** Strive to reduce freeway-related noise, air, and water pollution.
- EL-P23** Support the neighborhood’s visibility and identity from Interstate 5 through such means as landscaping and signage.

EASTLAKE
Residential Urban Village

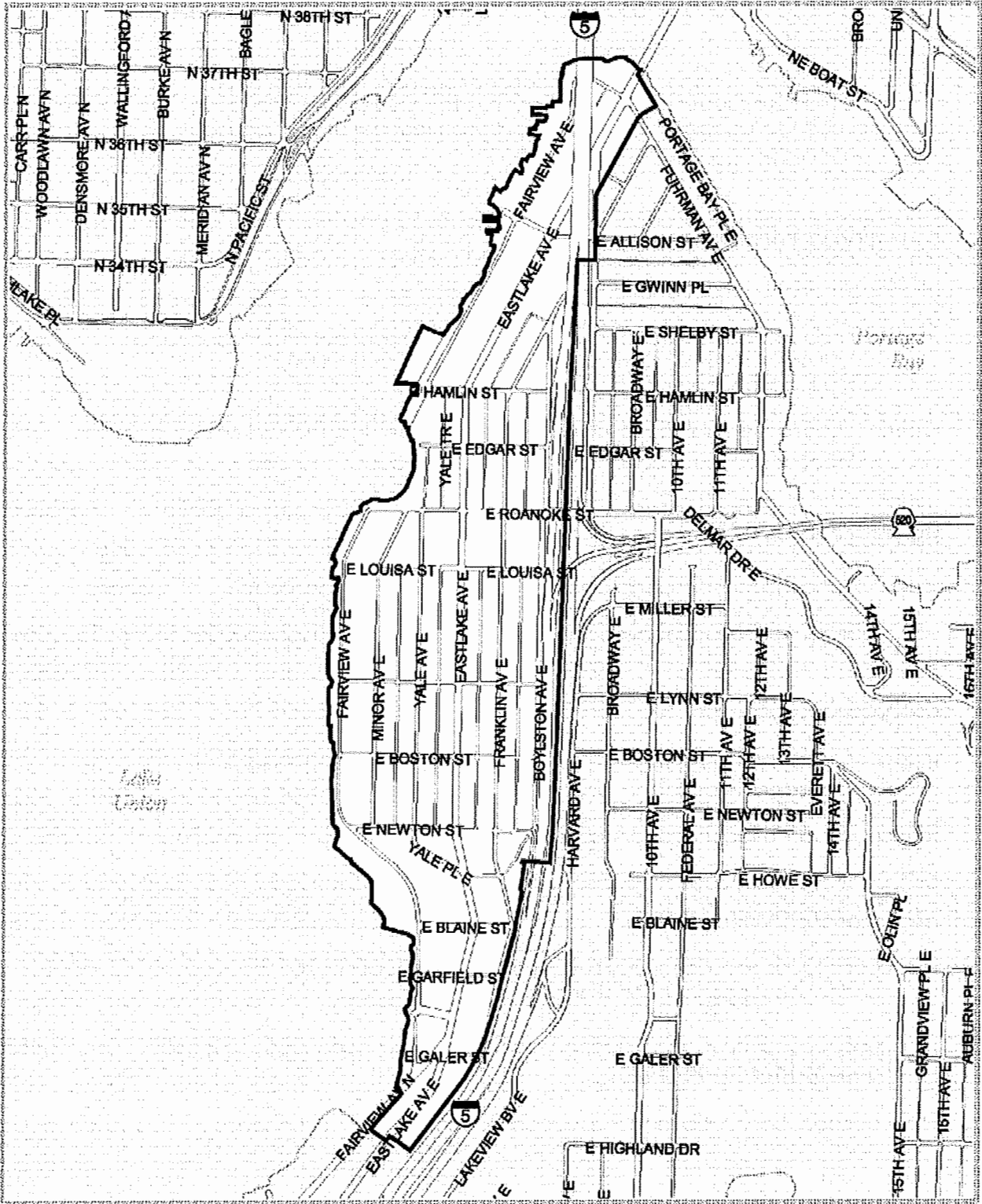

0 500 1000 Feet

— VILLAGE BOUNDARY
— EDGE OF PAVEMENT

EL-P24 Seek to implement the City's Urban Trail system within this neighborhood by completing pedestrian connections.

MAIN STREET GOAL

EL-G9 A neighborhood where residents and employees also shop and dine, that attracts and retains quality retail and services businesses, that is lively and busy during the day and evening, and that has a clean and vital main street that adds to the sense of community.

MAIN STREET POLICIES

EL-P25 Seek to attract new businesses and customers.

EL-P26 Pursue traffic, parking and local and express transit service improvements. King County/Metro buses that use Eastlake Ave E. should include at least two stops within the Eastlake neighborhood.

EL-P27 Seek to provide more planted medians for those parts of Eastlake Avenue in which businesses and abutting property owners support them.

DIVERSITY GOAL

EL-G9 A neighborhood in which neighbors know and help one another, value diversity, welcome people of any race, age, family makeup and economic status, maintain a close relationship with businesses and schools and in which community is a reality.

DIVERSITY POLICIES

EL-P28 Promote diversity among Eastlake's residents and strengthen their relationship with Eastlake's public school.

EL-P29 Build ties between Eastlake's business and residential communities.

AFFORDABLE HOUSING GOAL

EL-G10 A neighborhood including all socioeconomic groups with some housing units affordable to people with low-incomes.

AFFORDABLE HOUSING POLICY

EL-P30 Seek to expand housing opportunities in Eastlake for those with incomes under 80 percent, and especially for those under 50 percent, of the citywide median income.

First Hill

COMMUNITY CHARACTER GOALS

- FH-G1** A community with a culturally and economically diverse residential population, that is also a major employment center, home to many of the region's state-of-the-art medical centers and related facilities.
- FH-G2** An active, pedestrian-friendly urban center village that integrates residential, commercial, and institutional uses, and maintains strong connections to surrounding neighborhoods and the urban center.

COMMUNITY CHARACTER POLICIES

- FH-P1** Encourage mixed-use development in the Madison Street district to create more of a visual and functional center to the neighborhood and strengthen the relationship between the residential and commercial areas in First Hill.
- FH-P2** [Policy deleted by ordinance 122313.]
- FH-P3** Seek opportunities to provide additional community facilities to serve the existing diverse population and the new residents and employees projected to move into the neighborhood within the next fifteen years.
- FH-P4** Encourage the implementation of public safety measures to provide a safe environment for residents, employees, and patrons.
- FH-P5** Encourage major institutions and public projects to work to preserve, maintain, and enhance the important qualities of the neighborhood plan, i.e., open space, housing, and pedestrian environment.

ECONOMIC DEVELOPMENT GOAL

- FH-G3** A thriving business district that serves the needs of residents, employees, and visitors to First Hill.

ECONOMIC DEVELOPMENT POLICY

- FH-P6** Encourage longer hours of operation and an increased variety of businesses in First Hill.



HOUSING GOALS

- FH-G4** A neighborhood which provides a variety of housing opportunities that are compatible with other neighborhood goals, and maintains the economic mix of First Hill residents.

HOUSING POLICIES

- FH-P7** Encourage new housing development on underutilized sites.
- FH-P8** Explore joint housing development opportunities with the private sector, major institutions, and other public agencies.
- FH-P9** Encourage the retention and preservation of existing housing.
- FH-P10** Support a neighborhood infrastructure of attractive amenities and public facilities that attracts the development of new housing and preserves existing housing.
- FH-P11** Support the development of a strong commercial district that also serves the needs of the residential areas.

PUBLIC SAFETY GOAL

- FH-G5** A safe community for residents, employees, visitors, and shoppers.

PUBLIC SAFETY POLICIES

- FH-P12** Encourage a twenty-four-hour activity climate and increased street activity throughout the neighborhood as a crime deterrent by promoting eyes-on-the-street surveillance.
- FH-P13** Support community-based organizations and encourage partnerships with law enforcement agencies to make the neighborhood more safe and secure.
- FH-P14** Encourage the use of crime prevention through environmental design techniques for buildings, streets, and parks to minimize the ability for crime to take place.

HUMAN NEEDS & DEVELOPMENT GOALS

- FH-G6** A neighborhood that recognizes and meets the diverse and distinctly different human service needs of a culturally and economically diverse population.

HUMAN NEEDS & DEVELOPMENT POLICIES

- FH-P15** Promote community connections and cohesion by encouraging opportunities for people to come together, interact, support, and get to know each other and participate in a range of activities.

FIRST HILL
Part of the First Hill/Capitol Hill Urban Center

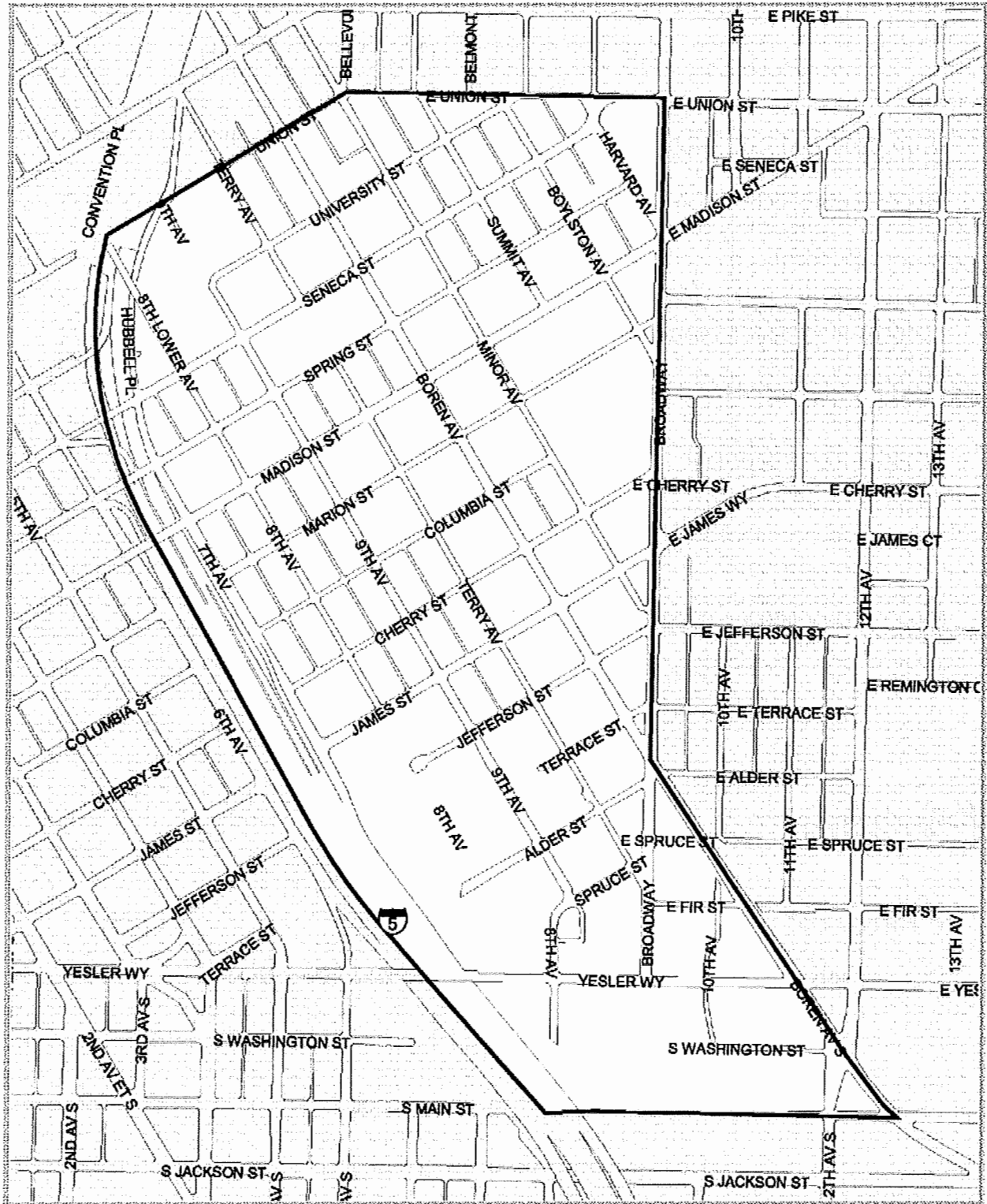

0 500 1000 Feet

— VILLAGE BOUNDARY
 - - - EDGE OF PAVEMENT

- FH-P16** Seek to improve communication between people, organizations, and communities dealing with human needs and development issues.
- FH-P17** Seek to address human support needs in the neighborhood.
- FH-P18** Seek a comprehensive approach in addressing the human needs and problems of people within the neighborhood.

PARKS, OPEN SPACE, & COMMUNITY FACILITIES GOALS

- FH-G7** A neighborhood with safe, accessible, and well-maintained parks, open space, and community facilities that meet the current and future needs of a growing community.

PARKS, OPEN SPACE, & COMMUNITY FACILITIES POLICIES

- FH-P19** Seek new opportunities for the creation of usable and safe parks and open space.

TRANSPORTATION GOALS

- FH-G8** A neighborhood that provides for the safe and efficient local- and through-traffic circulation of automobiles, transit, bicycles, and pedestrians.

TRANSPORTATION POLICIES

- FH-P20** Seek to resolve transportation and parking problems associated with being both a major medical employment center and a residential urban center village, and improve the environment for pedestrians.

Fremont

COMMUNITY CHARACTER GOALS

- F-G1** A neighborhood with unique character and opportunities that make Fremont the “Center of the Universe.”
- F-G2** A neighborhood with rich and varied urban streetscapes.
- F-G3** A neighborhood with a cohesive sense of community woven together by neighborhoods on both sides of Aurora Avenue North, south of Woodland Park.
- F-G4** A neighborhood that encourages the retention of important scenic view opportunities throughout the neighborhood.



COMMUNITY CHARACTER POLICIES

- F-P1** Encourage unique recreational and aesthetic amenities within the urban village.
- F-P2** Recognize Fremont's core retail area (Downtown Fremont) and shoreline (Lake Union and the Ship Canal) as important local urban amenities.
- F-P3** Encourage the development of public art, cultural amenities, and unique design treatments consistent with Fremont's character for the enjoyment and enrichment of users.
- F-P4** Strive to provide street amenities that will create an attractive urban environment and that recognize the importance of both vehicular and pedestrian uses.
- F-P5** Coordinate street improvements with other neighborhoods, where appropriate, to ensure a consistent approach.
- F-P6** Recognize the importance of commercial activities and adjacent residential neighborhoods and seek to balance and accommodate the needs of both on Fremont's streets.
- F-P7** Develop methods to link the communities on both sides of Aurora Avenue North to create a more cohesive and high-quality urban environment.
- F-P8** Strive to provide linkages that will enhance the livability of the Fremont neighborhood and encourage exchange between east and west, including the development of common open space.
- F-P9** Seek opportunities for improved vehicle access across/under Aurora Avenue North.
- F-P10** Strive to protect public view corridors and scenic opportunities throughout Fremont.
- F-P11** Explore ways to support incubator businesses in the city.
- F-P12** Consider capital improvements and infrastructure to be important for the Leary Way, upper Fremont Avenue North, and Stone Way business areas, as well as for the Fremont Hub Urban Village, because these areas provide goods and services to the Fremont Urban Village and their adjoining residential areas, and are accessible by walking, bicycling, carpooling, or public transit.
- F-P13** In the area where the Wallingford Urban Village and the Fremont Planning Area overlap (the area bounded by Stone Way on the east, N. 45th Street on the north, Aurora Avenue North on the west, and N. 40th Street on the south) maintain the character and integrity of the existing single-family zoned areas by maintaining current single-family zoning on properties meeting the locational criteria for single-family zones.

HOUSING GOALS

- F-G5** A neighborhood that is a desirable and an affordable community in which to live.

- F-G6 A neighborhood with a mix of housing affordability and types that enhance Fremont’s unique character.
- F-G7 A neighborhood with a stable residential population.

HOUSING POLICIES

- F-P14 Make use of existing tools in striving to assure that the impacts of new growth are mitigated.
- F-P15 Encourage programs and land use code regulations that support a mix of housing types and a range of affordability.
- F-P16 Encourage the development of housing in commercial areas.
- F-P17 Increase opportunities for homeownership.
- F-P18 Develop incentives for families to locate in the Fremont community.
- F-P19 Encourage the development of housing for senior citizens.
- F-P20 Seek to maintain existing, and encourage new, affordable rental housing.
- F-P21 Encourage neighborhood design quality, creativity, and character consistent with Fremont neighborhood design guidelines.
- F-P22 Encourage attractive, pedestrian-oriented streetscapes through design guidelines, zoning refinements, and streetscape improvements.
- F-P23 Support the creation of public art at key sites in the community.
- F-P24 Encourage high-density housing to locate in mixed-use areas and in close proximity to transit corridors.

TRANSPORTATION: PLANNING FOR THE FUTURE GOAL

- F-G8 A neighborhood with an efficient, safe, and community-compatible transportation system.

**TRANSPORTATION: SPECIFIC IDENTIFIED
TRANSPORTATION SYSTEMS ISSUES GOALS**

- F-G9 A neighborhood with efficient connections to Aurora Avenue North.
- F-G10 A Stone Way corridor that balances the needs of industrial access and general traffic capacity with bicycle and pedestrian safety.

TRANSPORTATION: SPECIFIC IDENTIFIED



FREMONT Hub Urban Village

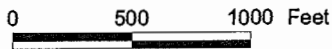

 VILLAGE BOUNDARY
 EDGE OF PAVEMENT

TRANSPORTATION SYSTEMS ISSUES POLICIES

- F-P25** Seek to develop efficient and safe connections between all sections of Fremont and Aurora Avenue North.
- F-P26** Seek to reduce or eliminate the use of local residential streets for access to Aurora Avenue North.
- F-P27** Seek to improve safety and convenience for pedestrians and bicyclists crossing Aurora Avenue North.
- F-P28** Strive to improve safety, access and circulation for local vehicular traffic, pedestrians, and bicycles.
- F-P29** Strive to improve access to waterfront industrial areas.

TRANSPORTATION: TRANSIT SERVICE & TRANSPORTATION MODES GOALS

- F-G11** A neighborhood served by a high level of public transportation that is responsive to community needs.
- F-G12** A neighborhood that encourages the use of modes of transportation other than the single-occupant automobile.
- F-G13** A neighborhood with active programs, such as car sharing, that reduce residents' reliance on ownership and operation of personal autos.

TRANSPORTATION: TRANSIT SERVICE & TRANSPORTATION MODES POLICIES

- F-P30** Seek to improve the convenience of transit access and transit connections in and around Fremont.
- F-P31** Strive to maximize Fremont access to planned citywide and regional transit services (e.g., Monorail, Sound Transit, water taxi, etc.).
- F-P32** Seek to establish safe and convenient pedestrian circulation to, from, and within the Downtown Fremont commercial area.
- F-P33** Improve safety and convenience of bicycle travel within and through the Fremont neighborhood.

TRANSPORTATION: DOWNTOWN FREMONT ACCESS & CIRCULATION GOAL

- F-G14** A "Downtown" Fremont with excellent circulation and accessibility.

**TRANSPORTATION: DOWNTOWN FREMONT
ACCESS & CIRCULATION POLICY**

F-P34 Seek to improve Downtown Fremont streets and traffic control systems to ensure efficient circulation and accessibility.

**TRANSPORTATION: ARTERIAL CORRIDOR
PEDESTRIAN IMPROVEMENT GOAL**

F-G15 A neighborhood with convenient and safe pedestrian access along and across arterials.

**TRANSPORTATION: ARTERIAL CORRIDOR
PEDESTRIAN IMPROVEMENT POLICY**

F-P35 Provide appropriate pedestrian crossings on arterials.

TRANSPORTATION: BICYCLE IMPROVEMENTS GOAL

F-G16 A neighborhood with convenient and safe options for bicycle travel within and through the Fremont neighborhood.

TRANSPORTATION: BICYCLE IMPROVEMENTS POLICIES

F-P36 Strive to improve connections among the main bicycle routes and trails passing through and serving Fremont.

F-P37 Encourage street improvements for bicycle safety and convenience where needed.

**TRANSPORTATION: TRAFFIC MANAGEMENT/CALMING &
SPOT IMPROVEMENT GOAL**

F-G17 A neighborhood that is safe for local travel and with minimal cut-through traffic on residential streets.

**TRANSPORTATION: TRAFFIC MANAGEMENT/CALMING &
SPOT IMPROVEMENT POLICY**

F-P38 Seek to provide local safety improvements and traffic-calming measures.

FREMONT ARTS GOALS

F-G18 A neighborhood that promotes its cultural and historic identity through the arts.

- F-G19 A neighborhood with community arts and cultural facilities and opportunities.
- F-G20 A neighborhood that supports the existing infrastructure of arts organizations to promote and fund public art.
- F-G21 A neighborhood with public access to art.
- F-G22 A neighborhood that encourages employment and small business development in conjunction with the arts.
- F-P42 Strive to ensure the inclusion of art in all public and private development.
- F-P43 Seek to utilize available publicly owned properties for cultural resource uses such as art and performing arts.

FREMONT ARTS POLICIES

- F-P39 Encourage support of the arts, artists, and arts organizations.
- F-P40 Encourage the dissemination of information for artists, businesses, and residents regarding City of Seattle regulatory matters.
- F-P41 Seek to promote awareness and recognition of Fremont public art.
- F-P44 Seek to make public and nonprofit use a priority for publicly owned properties.
- F-P45 Strive to promote and fund public art and community arts groups.

FREMONT ARTS: ARTIST LIVE-WORK HOUSING GOAL

- F-G23 A neighborhood with a supply of artist studios and artist live-work spaces.

FREMONT ARTS: ARTIST LIVE-WORK HOUSING POLICIES

- F-P46 Seek to preserve existing artist studio spaces in Fremont.
- F-P47 Encourage the development of artist live-work housing.

Georgetown

SEATTLE DESIGN DISTRICT GOAL

- G-G1 A healthy Georgetown area economy that capitalizes on the presence of the regionally significant design and gift centers and the related wholesale, retail,

design, and manufacturing trades to foster economic development and physical visibility of these industries.

SEATTLE DESIGN DISTRICT POLICIES

- G-P1** Encourage the development of a “design district” to capitalize on the economic vibrancy of the design and gift centers and the associated businesses.
- G-P2** Encourage economic development efforts designed to market design- and gift-related trades.

GEORGETOWN RESIDENTIAL NEIGHBORHOOD ANCHOR GOAL

- G-G2** A residential community that recognizes, preserves, and enhances Georgetown’s residential area as a viable place where people live, raise families, enjoy open spaces, and celebrate its unique historic character and buildings.

GEORGETOWN RESIDENTIAL NEIGHBORHOOD ANCHOR POLICIES

- G-P3** Seek to retain Georgetown’s residentially zoned lands as a means of providing affordable homeownership opportunities.
- G-P4** Seek to provide community facilities that meet a range of needs in the residential area of Georgetown.
- G-P5** Promote opportunities for the reuse of historic structures and other significant buildings and seek to create linkages between historic preservation and economic revitalization.
- G-P6** Seek opportunities for creating recreational facilities that can serve both the local residential population and employees.
- G-P7** Recognize Georgetown’s historic character and buildings and the presence of the design center when developing amenities and programs to reinforce Georgetown’s image as a quality place to live, work, raise a family, and/or own a business.

SAFER GEORGETOWN GOAL

- G-G3** A community that is safe and is perceived as safe for living, working, and doing business.

SAFER GEORGETOWN POLICIES

- G-P8** Emphasize crime prevention and community policing as public safety measures to help make Georgetown safe for residents, business owners, and employees.

- G-P9 Strive to raise public safety awareness in the business community and increase interaction between business people and the Seattle Police Department.
- G-P10 Seek ways to abate serious nuisance problems and develop strategies to address criminal activity.

PROMOTING INDUSTRY & FAMILY WAGE JOBS GOAL

- G-G4 An economically strong and vital manufacturing and industrial center that places priority on job creation, business growth, and ways for linking Georgetown residents to local jobs.

PROMOTING INDUSTRY & FAMILY WAGE JOBS POLICIES

- G-P11 Retain industrial-zoned land in Georgetown, while seeking out the potential to promote commercial and retail uses in commercial zones.
- G-P12 Promote the growth, development, and retention of industries and commerce that have the opportunity to flourish in Georgetown.
- G-P13 Balance the needs of water-dependent uses and natural/environmental habitat goals for the Duwamish Waterway.
- G-P14 Seek ways to develop, train, and connect the local workforce with Georgetown employers.

CODE ENFORCEMENT & PERMIT PROCESSING GOAL

- G-G5 A community that receives responsible and efficient City action in the abatement of illegal and criminal uses.

CODE ENFORCEMENT & PERMIT PROCESSING POLICY

- G-P14 Strive to deliver efficient, timely, and responsive code enforcement and permit processing as a means of promoting economic vibrancy and residential quality of life in Georgetown.

ECONOMIC DEVELOPMENT GOAL

- G-G6 A community that continues to support its businesses, promotes job growth, and receives the necessary public investment in infrastructure to continue economic vibrancy.



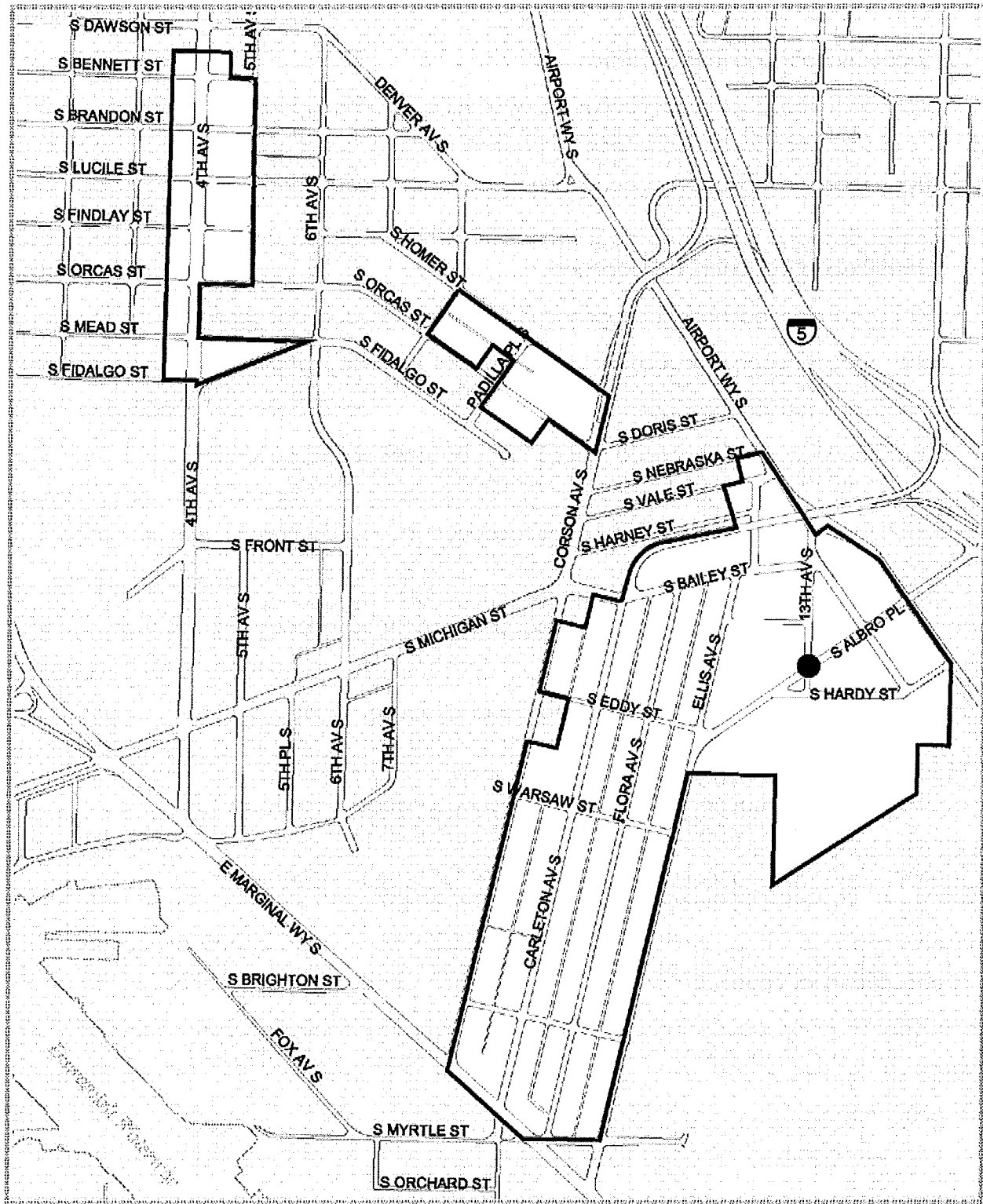

GEORGETOWN Neighborhood Anchor



0 500 1000 Feet

Note: the Georgetown neighborhood does not include an area designated as an urban village. The commercial and residential zoned areas boundary is shown for illustrative purposes only.

-  ANCHOR LOCATION
-  COMMERCIAL & RESIDENTIAL ZONED AREAS
-  EDGE OF PAVEMENT



- G-P16** Work with the community to explore ways of marketing Georgetown's commercial zones for commercial use, to help preserve industrial zones for industrial use, and to help encourage shopping opportunities for local residents in the commercial zones.

TRANSPORTATION FACILITIES GOAL

- G-G7** An integrated transportation network that addresses the freight mobility, highway access, and efficiency demands of all users; the nonmotorized and pedestrian needs of area residents; and that is supported by the basic services of good roads, transit service, and efficient area-wide circulation.

TRANSPORTATION FACILITIES POLICIES

- G-P17** Strive to minimize traffic congestion within the Georgetown neighborhood.
- G-P18** Work with other jurisdictions, such as King County and the City of Tukwila, to promote regional freight mobility for the Georgetown neighborhood and the Greater Duwamish Manufacturing/Industrial Center.
- G-P19** Address traffic safety concerns for both pedestrians and vehicles in Georgetown through means that could include improvements to roads and sidewalks.
- G-P20** Promote opportunities for nonmotorized transportation in the Georgetown neighborhood.
- G-P21** Work with Sound Transit, King County Metro Transit, and the residential and business communities to provide convenient and efficient transit mobility throughout Georgetown.

ENVIRONMENT GOALS

- G-G8** A community sensitive to environmental quality with a recognition and respect for the vital natural environment and ecosystems, such as the Duwamish River, that survive in Georgetown in the presence of commerce and industry
- G-G9** A community that reduces environmental hazards that threaten the health, safety, and general welfare of Georgetown's residents and employees.

ENVIRONMENT POLICIES

- G-P22** Promote awareness among Georgetown residents, employees, business owners, and property owners of environmental quality issues such as air, soil, and groundwater pollution.
- G-P23** Work with other jurisdictions to protect the environmental quality of the Duwamish watershed.

- G-P24** Seek ways to monitor the environmental impacts of the King County International Airport in the Georgetown community, while recognizing its economic significance.

Greater Duwamish Manufacturing/ Industrial Center

JOBS & ECONOMICS GOALS

- GD-G1** The Duwamish Manufacturing/Industrial Center remains economically vital.
- GD-G2** Public infrastructure adequate to serve business operations in the Duwamish Manufacturing/Industrial Center is provided.
- GD-G3** Land in the Duwamish Manufacturing/ Industrial Center is maintained for industrial uses including the manufacture, assembly, storage, repair, distribution, research about or development of tangible materials and advanced technologies; as well as transportation, utilities, and commercial fishing activities.
- GD-G4** The City regulatory environment facilitates location and expansion of industrial businesses in the Duwamish Manufacturing/Industrial Center.

JOBS & ECONOMICS POLICIES

- GD-P1** Recognize the significant contribution of the industries and businesses in the Duwamish Manufacturing/Industrial Center in terms of the jobs they create, and the export and tax revenues they generate.
- GD-P2** Strive to retain existing businesses and promote their viability and growth, with particular emphasis on small businesses.
- GD-P3** Encourage new industrial businesses that offer family-wage jobs to locate in the area.
- GD-P4** Encourage site assembly that will permit expansion or new development of industrial uses.
- GD-P5** Limit the location or expansion of nonindustrial uses, including publicly sponsored nonindustrial uses, in the Duwamish Manufacturing/Industrial Center.
- GD-P6** Strive to separate areas that emphasize industrial activities from those that attract the general public.
- GD-P7** Continue to promote timeliness, consistency, coordination, and predictability in the permitting process.

LAND USE GOALS

- GD-G5** Land in the Duwamish Manufacturing/Industrial Center is sufficient to allow an increase in the number of family-wage industrial jobs that can be filled by workers with diverse levels of education and experience.
- GD-G6** The Duwamish waterway continues as a working industrial waterfront that retains and expands in value as a vital resource providing family-wage jobs and trade revenue for the city, region, and state.
- GD-G7** The City and other government bodies recognize the limited industrial land resource and the high demand for that resource by private industrial businesses within the Duwamish Manufacturing/Industrial Center when considering the siting of public uses there.
- GD-G8** The Duwamish Manufacturing/Industrial Center remains a manufacturing/industrial center promoting the growth of industrial jobs and businesses and strictly limiting incompatible commercial and residential activities.

LAND USE POLICIES

- GD-P8** Strive to protect the limited and nonrenewable regional resource of industrial, particularly waterfront industrial, land from encroachment by nonindustrial uses.
- GD-P9** Distinguish between the industrial zones in the Duwamish Manufacturing/Industrial Center by the amount and types of uses permitted in them.
- GD-P10** If industrial land south of South Park is annexed to the city, include much of it in the Duwamish Manufacturing/Industrial Center, with appropriate land use controls to encourage industrial uses and discourage nonindustrial uses.
- GD-P11** Strive to maintain sufficient capacity in the shoreline areas for anticipated water-dependent industrial uses.
- GD-P12** Seek to preserve the Duwamish Waterway's ability to function as the city's gateway to the Pacific and to provide adequate nearby land for warehousing and distribution that serve the shipping industry.
- GD-P13** Especially along the waterway, discourage conversion of industrial land to nonindustrial uses.
- GD-P14** Maintain shoreside freight access to and from the waterway.
- GD-P15** Strive to increase the trade revenues generated by Seattle's water-dependent industries.
- GD-P16** Consider a variety of strategies, including possible financial incentives, to retain and attract marine businesses.
- GD-P17** Encourage other jurisdictions to:
1. avoid locating nonindustrial uses in the Duwamish Manufacturing/Industrial Center;

DUWAMISH Manufacturing/Industrial Center

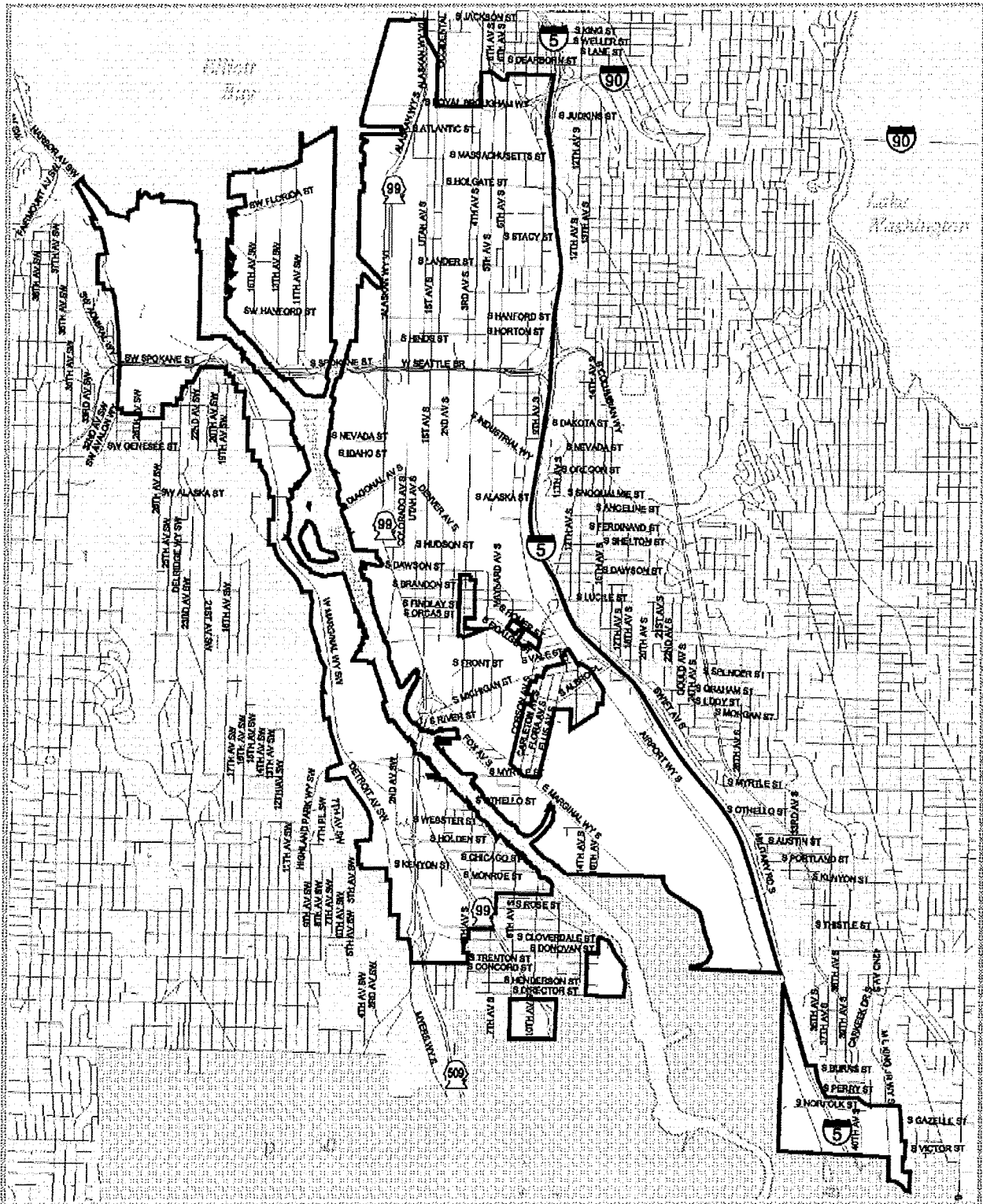

2. consolidate public facilities to minimize the amount of land consumed by the public sector; and
3. pursue joint operations and colocation so that facilities can serve more than one jurisdiction.

- GD-P18** Encourage public agencies, including City agencies, to explore ways of making property available for private industrial uses when disposing of property in the Duwamish Manufacturing/Industrial Center.
- GD-P19** Prohibit certain commercial uses and regulate the location and size of other commercial uses in the manufacturing/industrial center.
- GD-P20** Seek to integrate stadium and stadium-related uses into the Duwamish Manufacturing/Industrial Center by creating an overlay district limited to the area near the stadiums that discourages encroachment on nearby industrial uses, creates a pedestrian connection from the stadiums north to Downtown, and creates a streetscape compatible with Pioneer Square.

TRANSPORTATION GOALS

- GD-G9** A high level of general mobility and access is attained within the Duwamish Manufacturing/Industrial Center.
- GD-G10** The transportation network in the Duwamish Manufacturing/Industrial Center makes appropriate connections and minimizes conflicts between different travel modes.
- GD-G12** The transportation network in the Duwamish Manufacturing/Industrial Center emphasizes the mobility of freight and goods.
- GD-G13** Rail service in the Duwamish Manufacturing/Industrial Center remains safe and efficient.
- GD-G14** Well-maintained streets and facilities serve all the properties in the Duwamish Manufacturing/Industrial Center.
- GD-G15** Sufficient transportation infrastructure, particularly in the northern portion of the Duwamish Manufacturing/Industrial Center, minimizes the transportation impacts of special events on industrial users.
- GD-G16** The public transit system provides employee access to the Duwamish Manufacturing/Industrial Center while minimizing impacts on freight mobility.

TRANSPORTATION POLICIES

- GD-P21** Strive to enhance access throughout the Duwamish Manufacturing/Industrial Center by means such as signal coordination, roadway channelization, grade separation, and pavement rehabilitation.



- GD-P22** Encourage use of Airport Way as an alternate route for commute trips that might otherwise use First and Fourth Avenues.
- GD-P23** Strive to maintain the existing capacity on roadways and bridges and encourage use of underused facilities.
- GD-P24** Encourage maintenance of a connection across the Duwamish River that provides access to the South Park area while allowing the river to continue serving marine traffic.
- GD-P25** Strive to maintain arterial/rail crossings until those crossings can be replaced with grade separations.
- GD-P26** Recognize and strive to address the cumulative traffic effects that transportation and development projects in and near the Duwamish Manufacturing/Industrial Center can have on freight mobility.
- GD-P27** Pursue opportunities and develop partnerships to provide grade separations between rail and auto/truck traffic along key east-west routes for enhanced speed and reliability while maintaining safety for both travel modes.
- GD-P28** Encourage the design of bicycle and pedestrian facilities in the Duwamish Manufacturing/Industrial Center that minimize conflicts between motorized and nonmotorized traffic and promote both traffic flow and safety.
- GD-P29** Strive to maintain waterborne and roadway access to seaport facilities.
- GD-P30** Strive to maintain access for air cargo to the King County International Airport.
- GD-P31** Strive to facilitate east-west freight movement in the Duwamish Manufacturing/Industrial Center, particularly through the Royal Brougham, Spokane Street, and Michigan Street corridors.
- GD-P32** Strive to maintain efficient freight movement along designated truck routes in the Duwamish Manufacturing/Industrial Center.
- GD-P33** Strive to maintain reasonable access to regional transportation facilities for goods distribution from all areas of the Duwamish Manufacturing/Industrial Center.
- GD-P34** Recognize the importance of intermodal connections for the movement of freight between the state highway system, rail yards, barge terminals, Port terminals, airports, and warehouse/distribution centers.
- GD-P35** Strive to minimize disruptions to freight mobility caused by construction (including construction of transportation facilities) in the Duwamish Manufacturing/Industrial Center.
- GD-P36** In setting priorities for roadway repairs in the Manufacturing/Industrial Center, consider the importance of those facilities to freight mobility.
- GD-P37** Consider setting speed limits for trains high enough to limit the length of time trains block streets at grade crossings.

- GD-P38** Encourage railroad operations in which switching and signals enhance the speed and reliability for passenger and freight trains.
- GD-P39** Encourage a working relationship between the City and property and business owners in the area to identify possible funding sources for non-arterial road and drainage improvements.
- GD-P40** Encourage the efficient use of transit opportunities, including the E-3 busway, to expedite the movement of event patrons in and out of the Duwamish Manufacturing/Industrial Center.
- GD-P41** Encourage the management of event parking in ways that minimize the impacts on congestion in the Duwamish Manufacturing/Industrial Center.
- GD-P42** Strive to maintain parking that serves local businesses during special events.
- GD-P43** Strive to maintain sufficient rail spurs to accommodate existing and potential future business needs in the Duwamish Manufacturing/Industrial Center.
- GD-P44** Encourage employees in the Duwamish Manufacturing/Industrial Center to use public transit for commuting to work through means such as employer-subsidized bus passes and enhanced transit service.
- GD-P45** Seek to minimize impacts on freight mobility in the design of new or expanded transit facilities in the Duwamish Manufacturing/Industrial Center.

UTILITIES GOAL

- GD-G17** The network of utilities is sufficient to meet the needs of businesses in the area.

UTILITIES POLICIES

- GD-P46** Strive to maintain affordable rates for City-operated utilities serving the Duwamish Manufacturing/Industrial Center.
- GD-P47** Strive to provide stormwater facilities that help increase pavement durability.

ENVIRONMENTAL REMEDIATION GOAL

- GD-G18** Sufficient incentives exist in the industrial area so that the private sector can remedy environmental contamination and contribute to the expansion of the industrial job base.

PUBLIC SAFETY GOALS

- GD-G19** The community makes use of crime prevention resources in the Duwamish Manufacturing/Industrial Center and adjacent residential communities to control crime and increase the sense of security in the area.

GD-G20 Public investments contribute to a sense of community identity and enhance public safety.

PUBLIC SAFETY POLICIES

GD-P48 Recognize crime prevention as a significant contributor to economic vitality in the Duwamish Manufacturing/Industrial Center and to the quality of life in the surrounding residential communities.

GD-P49 Encourage the use of community policing techniques to increase personal safety.

GD-P50 Consider techniques such as neighborhood identification and wayfinding signs to increase pride in the community and to facilitate navigation through the Duwamish Manufacturing/Industrial Center.

Green Lake

COMMUNITY CHARACTER GOALS

GL-G1 A vibrant residential urban village with pedestrian-friendly streetscapes that preserve and enhance the unique scale and character of the village.

GL-G2 A neighborhood with a safe and attractive pedestrian and bicycle network of streets, districts, and corridors.

COMMUNITY CHARACTER POLICIES

GL-P1 Support zoning designations that will encourage new development to harmonize with the existing historical building, streetscapes, and pedestrian-friendly character.

GL-P2 Strive to create a vital and identifiable main street along Woodlawn Avenue.

GL-P3 Encourage linkages between the lake and the commercial district through public open space, such as a public plaza.

GL-P4 Strengthen and enhance the existing architectural character and scale of the urban village.

GL-P5 Encourage a lively and thriving business core.

GL-P6 Strive to create safe and attractive pedestrian network linkages to Green Lake, Sound Transit, and other community resources.

GL-P7 Encourage commercial facades that are distinctive and that enhance neighborhood character and the overall visual quality of the streetscape.

GL-P8 Seek to enhance the visual and pedestrian appeal of key streets radiating from the lake.

GL-P9 Encourage improvements that will provide a sense of entry/gateway into the Green Lake neighborhood.

TRANSPORTATION GOAL

GL-G3 A street system that safely and efficiently accommodates traffic volumes with sufficient capacity and speed.

TRANSPORTATION POLICIES

GL-P10 New development should be designed to encourage the use of public transportation and discourage single-occupant vehicular use.

GL-P11 Encourage an integrated transportation and transit system with positive impacts on existing uses and long-term redevelopment opportunities.

PARKING GOAL

GL-G4 An urban village with an adequate parking supply for residents and businesses that does not detract from village character and does not create significant traffic impacts.

PARKING GOAL

GL-P12 Encourage the better use of existing parking and examine new and innovative parking options.

TRANSIT GOAL

GL-G5 A neighborhood with convenient, predictable, and reliable transit service that provides access to surrounding activity areas, adjacent neighborhoods, local transit hubs, and regional transit stations.

TRANSIT POLICIES

GL-P13 Encourage frequent and reliable transit service.

GL-P14 Strive to improve local neighborhood transit and citywide transit connections to Green Lake.

GL-P15 Consider alternative transit technology, including the use of smaller buses and vans, on low-ridership routes.



TRAFFIC-CALMING GOAL

GL-G6 A neighborhood with good auto access and safe streets that do not significantly encourage additional traffic, particularly in residential areas.

TRAFFIC-CALMING POLICY

GL-P16 Strive to minimize the impact of automobile and transit traffic on the neighborhood.

BICYCLE ACCESS GOAL

GL-G7 A neighborhood with safe, efficient bicycle facilities.

BICYCLE ACCESS POLICIES

GL-P17 Improve bicycle safety and access to the neighborhood and regional system for both transportation and recreation purposes.

GL-P18 Support the development of the bicycle/pedestrian corridor linkages that connect Green Lake to regional trail systems such as the Burke-Gilman Trail.

GL-P19 Strive to provide facilities and other improvements for bicycles in the neighborhood.

GL-P20 Promote cycling for short to medium-length trips and commutes to work.

PEDESTRIAN FACILITIES GOAL

GL-G8 A neighborhood with safe, accessible, and enjoyable pedestrian facilities.

PEDESTRIAN FACILITIES POLICIES

GL-P21 Provide improvements for good pedestrian access to Green Lake, with particular focus on people with disabilities, including curb cuts for wheelchair users.

GL-P22 Strive to ensure wheelchair accessibility to Green Lake Park.

GL-P23 Strive to improve pedestrian access across both Aurora Avenue North and Interstate 5.

HOUSING GOALS

GL-G9 An urban village with affordable housing opportunities.

GL-G10 A neighborhood with housing for a range of income levels that is compatible with the existing single-family character of the neighborhood.



GREEN LAKE Residential Urban Village

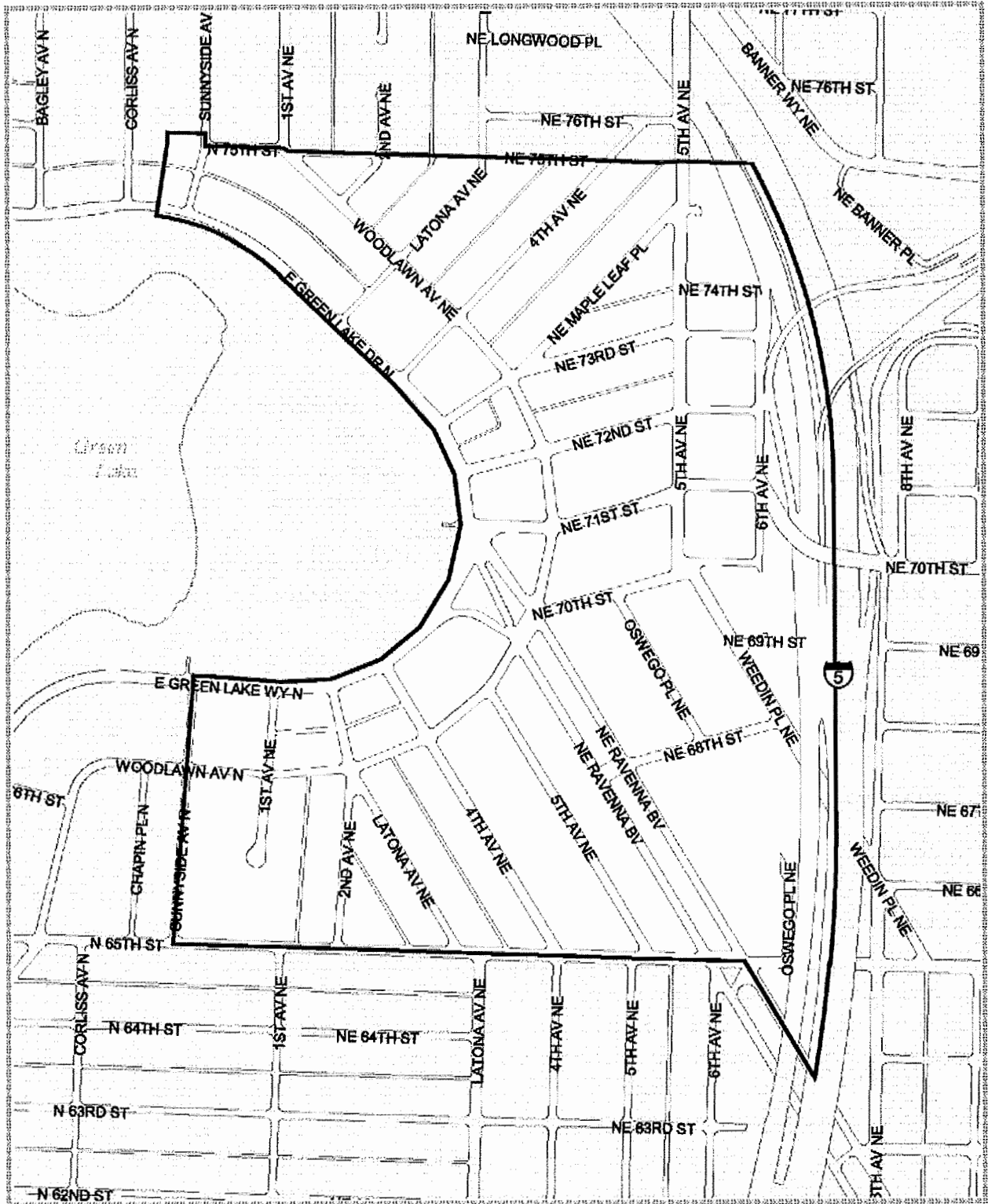

0 500 1000 Feet

VILLAGE BOUNDARY
EDGE OF PAVEMENT

HOUSING POLICIES

- GL-P24** Encourage development that is supportive of housing goals and mixed-use development.
- GL-P25** To support the vision of the Green Lake residential urban village and its housing goals and to accommodate growth targets, Midrise 60 zoning is appropriate in the area bounded by Interstate 5, Fifth and Sixth Avenues NE, NE Maple Leaf Place, and NE 70th Street.

LAND USE GOAL

- GL-G11** A community with neighborhood design guidelines that continue and enhance the desired community character.

LAND USE POLICIES

- GL-P26** Seek to preserve scale and rhythm between structures, especially in areas bordering single-family homes.
- GL-P27** Seek to conserve noteworthy structures and their structural components.

HUMAN SERVICES GOALS

- GL-G12** An urban village with enhanced availability of human services.
- GL-G13** A neighborhood with a community center that provides meeting and arts facilities and social services for neighborhood residents.

HUMAN SERVICES POLICIES

- GL-P28** Provide community facilities with social and recreation opportunities that match the diversity and demographics of the neighborhood, including the needs of teens and seniors.
- GL-P29** Encourage cooperative efforts with the school district to enhance community use of school properties.

PARKS & OPEN SPACE GOAL

- GL-G14** A neighborhood with green space and other recreation opportunities throughout the planning area that are equally accessible to all residents regardless of disability.

PARKS & OPEN SPACE POLICIES

- GL-P30** Strive to increase the amount of open space in the neighborhood.
- GL-P31** Enhance the health and quality of vehicle and pedestrian corridors by adding trees and other vegetation.
- GL-P32** Support the creation of additional recreational activities and increased awareness of and accessibility to recreational resources.

HABITAT ISSUES GOALS

- GL-G15** A neighborhood with an abundance of native habitat that supports native wildlife.
- GL-G16** A community with restored and protected natural drainage systems.

HABITAT ISSUES POLICIES

- GL-P33** Pursue open space and habitat improvements opportunities on public lands that provide multiple environmental benefits.
- GL-P34** Encourage public involvement, appreciation, and stewardship of native habitats.
- GL-P35** Support increased environmental education and interpretation opportunities and public awareness of environmental issues.
- GL-P36** Support programs for water quality and watershed awareness.
- GL-P37** Recognize the natural drainage system as a centerpiece of environmental education, habitat restoration, and revegetation activities.

ECONOMIC DEVELOPMENT GOAL

- GL-G17** A neighborhood with a vital business community.

ECONOMIC DEVELOPMENT POLICIES

- GL-P38** Recognize the neighbor-friendly character and vitality in the neighborhood's four principal commercial areas.
- GL-P39** Strive to attract and nurture a positive mix of independent, pedestrian-oriented businesses serving local needs.
- GL-P40** Encourage businesses and new development to establish and maintain pedestrian gathering areas, such as green space, sculptures, and fountains.

Greenwood/Phinney Ridge

LAND USE & COMMUNITY CHARACTER GOALS

- G/PR-G1** A vital Greenwood commercial area with a pedestrian-friendly streetscape.
- G/PR-G2** A neighborhood with vital, pedestrian-friendly main streets that connect all the commercial areas.
- G/PR-G3** A neighborhood with streets that are green, tree-lined, pedestrian and bicycle-friendly, and contribute to an integrated open space system.
- G/PR-G4** A neighborhood with public viewsapes and view corridors available for public enjoyment.
- G/PR-G5** A high-quality living environment with areas of higher densities concentrated where services are located.
- G/PR-G6** A neighborhood that grows in a manner that is compatible with existing scale and character.
- G/PR-G7** A neighborhood where the scale and character of historical or existing single-family areas have been maintained.
- G/PR-G8** A neighborhood where public amenities and necessary infrastructure are focused to areas planned for growth.
- G/PR-G9** A neighborhood with a strong sense of identity and history.

LAND USE & COMMUNITY CHARACTER POLICIES

- G/PR-P1** Encourage the conservation of original structures and facades that define Greenwood/Phinney Ridge's architectural and historic character.
- G/PR-P2** Encourage integrated design guidelines that promote mixed-use development similar to historic neighborhood development patterns as well as a high level of neighborhood design quality, creativity, and character.
- G/PR-P3** Seek to strategically place public facilities near the Main Street along Greenwood Avenue North and Phinney Avenue North and North 85th Street.
- G/PR-P4** Encourage development in commercial and multifamily zones that is consistent and compatible with neighborhood scale and character.
- G/PR-P5** Encourage easy access by foot, bicycle and transit to the urban village and along the Main Street along Greenwood Ave North and Phinney Ave North and N 85th Street.
- G/PR-P6** Encourage the use of decorative paving, lighting, plantings and benches to encourage a vital and pedestrian-friendly main street.

- G/PR-P7** Seek to provide infrastructure to support growth as and where growth occurs.
- G/PR-P8** Seek to provide a landscaped civic plaza around the Phinney Neighborhood Association building near the intersection of North 67th Street and Phinney Avenue North.
- G/PR-P9** Strive to preserve the existing public view corridors that characterize the openness of the neighborhood and seek to provide new view corridors where possible.
- G/PR-P10** Consider capital improvements and infrastructure to be important for the commercial area along Greenwood/ Phinney Avenue North from the Woodland Park Zoo to North 105th Street, as well as for the Greenwood/Phinney Ridge Residential Urban Village, because this area provides goods and services to the Greenwood/ Phinney Ridge Residential Urban Village and their adjoining residential areas, and is accessible by walking, bicycling, carpooling, or public transit.

HOUSING GOAL

- G/PR-G10** A neighborhood with a varied housing stock and a wide range of affordability that serves a diverse population.

HOUSING POLICIES

- G/PR-P11** Support the development of accessory dwelling units (ADUs) as a means to accommodate planned housing growth.
- G/PR-P12** Encourage the maintenance of existing viable housing stock for affordable housing.
- G/PR-P13** Support programs that allow existing owners and renters to stay in their homes.
- G/PR-P14** Support the development of smaller affordable housing units.

PUBLIC SAFETY GOAL

- G/PR-G11** A neighborhood with a low crime rate, safe streets, no graffiti, and lighting for safety.

PUBLIC SAFETY POLICIES

- G/PR-P15** Strive to provide excellent police presence in the neighborhood.
- G/PR-P16** Encourage community involvement in programs and activities that promote public safety.

HUMAN NEEDS & DEVELOPMENT GOALS

- G/PR-G12** Vibrant arts organizations that are supported and strengthened by the community.

GREENWOOD/PHINNEY RIDGE Residential Urban Village

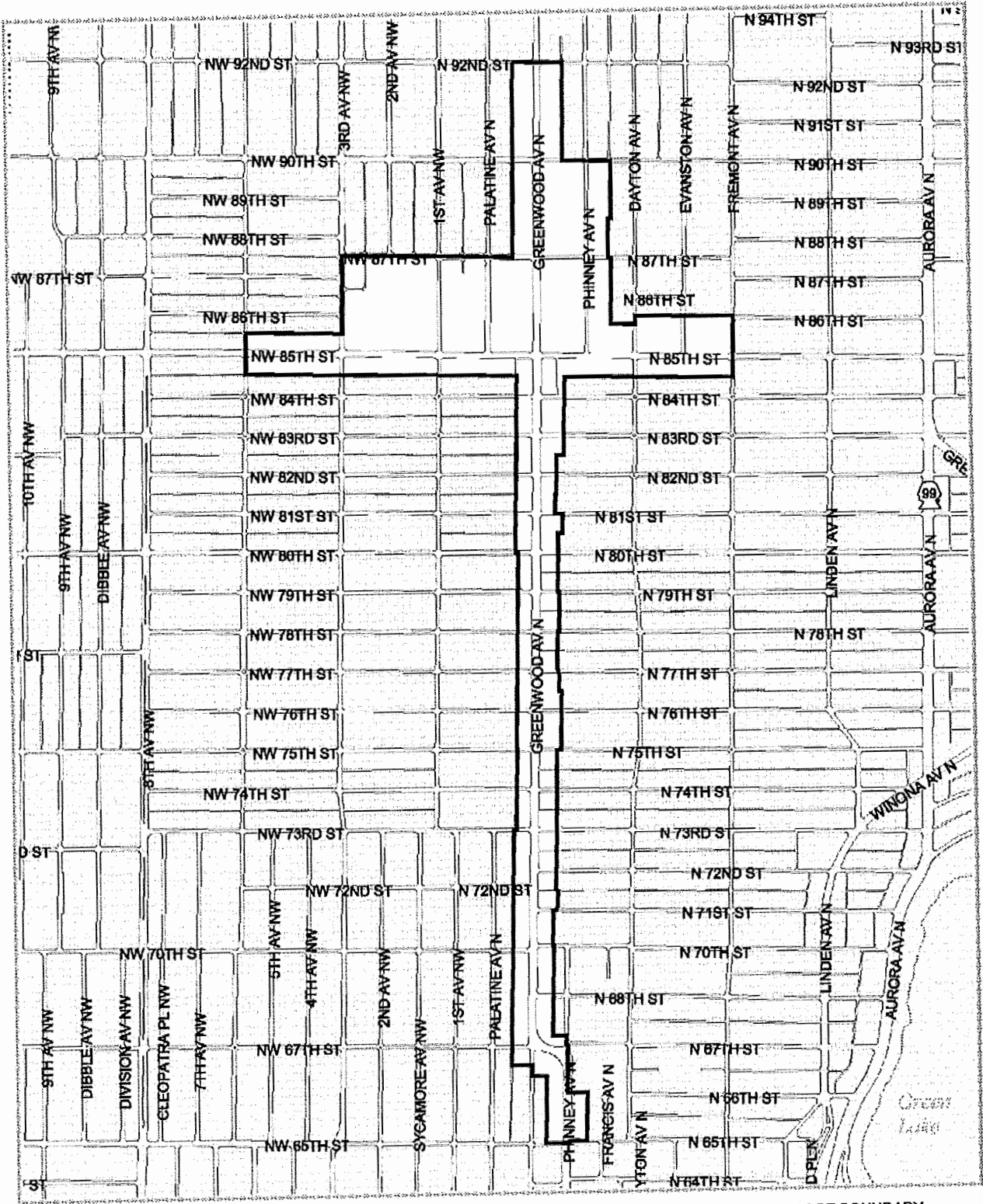

0 500 1000 Feet

VILLAGE BOUNDARY
EDGE OF PAVEMENT

G/PR-G13 A neighborhood with well-maintained and strong human service facilities and programs.

HUMAN NEEDS & DEVELOPMENT POLICY

G/PR-P17 Encourage community involvement in programs and activities that promote the arts.

PARKS, OPEN SPACE, & COMMUNITY FACILITIES GOALS

G/PR-G14 A neighborhood with active and vibrant neighborhood meeting places.

G/PR-G15 A neighborhood with an abundance of opportunities for active and passive recreation.

G/PR-G16 A full-service recreational facility that serves the Greenwood/Phinney Ridge Urban Village.

G/PR-G17 A neighborhood with a full-service library.

PARKS, OPEN SPACE, & COMMUNITY FACILITIES POLICIES

G/PR-P18 Strive to create and maintain active and vibrant community facilities, such as the Phinney Neighborhood Center and a new community center in Greenwood.

G/PR-P19 Provide a variety of opportunities for active and passive recreation in the neighborhood.

G/PR-P20 Seek accessibility and attractiveness at all community facilities

G/PR-P21 Encourage new development, both public and private, to provide trees and greenery, pedestrian amenities, and improved streetscapes as part of facility design.

G/PR-P22 Strive to create a variety of green spaces through landscaping with benches or other amenities that encourage people to linger, gather, and converse.

G/PR-P23 Encourage the colocation of compatible community programs and activities.

G/PR-P24 Consider vacant/undeveloped land and surplus City-owned properties, such as Seattle City Light right-of-way, within the neighborhood for recreational use and as green space.

G/PR-P25 Encourage a network of bikeways and walkways that are safe, clearly identifiable, and attractive, that connect neighborhoods to parks, neighborhoods to neighborhoods, and commercial areas to open space.

G/PR-P26 Explore mechanisms, including LIDs, as an option to fund comprehensive infrastructure improvements.



ENVIRONMENT GOALS

- G/PR-G18** A neighborhood that protects and improves ecological and environmental health and that supports environmental awareness.
- G/PR-G19** Neighborhood streets with good storm drainage.

ENVIRONMENT POLICIES

- G/PR-P27** Strive to increase infiltration of runoff by minimizing the use of impermeable surfaces.
- G/PR-P28** Encourage the development of systems that both control runoff and improve water quality.
- G/PR-P29** Seek to mitigate storm overflow surges into Pipers Creek and other waterways.
- G/PR-P30** Strive to improve the ecological function of Pipers Creek.
- G/PR-P31** Promote environmental education and outreach in the neighborhood.

TRANSPORTATION GOALS

- G/PR-G20** A neighborhood with adequate off-street parking facilities throughout the commercial area.
- G/PR-G21** A neighborhood where heavily traveled streets are pedestrian-friendly and attractively landscaped.
- G/PR-G22** A neighborhood with efficient and safe traffic flow and numerous safe pedestrian crossings.
- G/PR-G23** A neighborhood circulation system that minimizes vehicular traffic impacts on residential areas.
- G/PR-G24** A neighborhood with convenient and frequent transit service that provides access to neighborhood commercial and activity areas, adjacent neighborhoods, local transit hubs, and regional transit stations.
- G/PR-G25** A neighborhood with a variety of available transportation modes.
- G/PR-G26** Neighborhood streets with adequate and safe public walkways.

TRANSPORTATION POLICIES

- G/PR-P32** Strive to minimize the negative impacts of parking and vehicular access on residential streets.
- G/PR-P33** Strive to implement a street tree program with priority on the most visible locations such as along arterials and in commercial areas.

- G/PR-P34** Seek to extend the regional trail systems that link to the Burke-Gilman Trail.
- G/PR-P35** Strive to “green” North and Northwest 85th Street within the commercial area.
- G/PR-P36** Strive to ensure safe and convenient pedestrian access across and under Aurora Avenue North to Green Lake Park.
- G/PR-P37** Seek transit operations that move traffic more efficiently, and have convenient pedestrian access to transit stops.
- G/PR-P38** Seek to coordinate traffic signals throughout the neighborhood and to improve traffic flow at 85th Street and Greenwood Avenue North.
- G/PR-P39** Encourage new development to be designed in ways that encourage the use of public transportation and discourage single-occupant vehicular use.
- G/PR-P40** Encourage additional transit opportunities, such as a shuttle service to link with other transit and shuttle routes, and tie in with the proposed Sound Transit light rail system.
- G/PR-P41** Look for opportunities to link existing and future public parking facilities with shuttle and bus systems as well as pedestrian walkways as an incentive to minimize local neighborhood car trips.
- G/PR-P42** Strive to provide improvements for pedestrians to cross busy streets at selected locations, with particular focus for people with disabilities.
- G/PR-P43** Encourage the participation of the community in the planning and prioritizing of transportation improvement projects such as walkways, traffic-calming, bike and pedestrian trails, transit facilities and traffic signal timing, traffic capacity distributions and modifications and others.
- G/PR-P44** Strive to provide public walkways on streets where they are needed and in areas prioritized by the neighborhood with an emphasis on the main streets along Greenwood Avenue North and Phinney Avenue North and North 85th Street.

Morgan Junction

COMMUNITY CHARACTER GOAL

- MJ-G1** An attractive community where the buildings, streets, and sidewalks form a comfortable human-scale setting for daily activities and where views and community character are protected.

TRAFFIC & TRANSPORTATION GOAL

- MJ-G2** A community that is conveniently accessible by transit and automobile, and where walking and biking are an integral part of the transportation system.

TRAFFIC & TRANSPORTATION POLICIES

- MJ-P1** Seek to develop design modifications for Fauntleroy Way so that it is more integrated aesthetically.
- MJ-P2** Enhance pedestrian access and vehicle and bicycle mobility throughout the neighborhood, with particular attention to the Fauntleroy Way, the California Avenue SW, and the 35th Avenue SW corridors.
- MJ-P3** Encourage pedestrian and bicycle linkages to other Seattle neighborhoods.

PARKS & OPEN SPACE GOAL

- MJ-G3** A community with an appealing nature, with attractive landscaping and pleasant parks and gathering places where walking and biking are easy and enjoyable.

PARKS AND OPEN SPACE POLICIES

- MJ-P4** Seek future open space opportunities and acquisitions to provide additional “breathing room” to the Morgan Junction neighborhood.
- MJ-P5** Seek to keep unused and unimproved street rights-of-way and alleys in City ownership, eliminate encroachment on these areas, and identify them with clear public signage to encourage public use.
- MJ-P6** Seek opportunities, particularly within the business district, to provide additional open space and to create open space/plazas that serve as community gathering places.
- MJ-P7** Encourage the creation of open spaces in conjunction with pedestrian and bicycle linkages throughout the neighborhood.
- MJ-P8** Seek opportunities to reclaim unneeded portions of public rights-of-way to develop open space and trails where appropriate and support the “Green Crescent” concept described in the Morgan Junction Neighborhood Plan.
- MJ-P9** Seek opportunities to revegetate parks and open spaces with native plants and reintroduce native plant species to appropriate habitats.
- MJ-P10** Support the development of distinctive neighborhood gateways at north and south entries into the Morgan Junction neighborhood and business district with associated open space and/or landscaped areas and signage.
- MJ-P11** Seek to provide safe, green, and aesthetically pleasing arterial streets through the neighborhood with improvements focused on Fauntleroy Way SW and California Avenue SW.

BUSINESS DISTRICT GOAL

- MJ-G4** A community with a vital commercial district that provides restaurants, stores, and services to meet the needs of local residents.

BUSINESS DISTRICT POLICY

- MJ-P12** Strive to balance the goal of a compact urban village with the need for adequate parking, traffic circulation, and pedestrian safety on neighborhood streets.

HOUSING & LAND USE GOAL

- MJ-G5** A community with strong single-family neighborhoods and compatible multifamily buildings offering a wide range of housing types for all people.

HOUSING AND LAND USE POLICIES

- MJ-P13** Maintain the character and integrity of the existing single-family designated areas by maintaining current single-family zoning both inside and outside the urban village on properties meeting the locational criteria for single-family zones, except where, as part of a development proposal, a long-standing neighborhood institution is maintained and existing adjacent community gathering places are activated, helping to meet MJ-P6.
- MJ-P14** Ensure that use and development regulations are the same for single-family zones within the Morgan Junction Urban Village as those in corresponding single-family zones in the remainder of the Morgan Junction Planning Area.
- MJ-P15** The special Lowrise 3 (L3) and Lowrise 4 (L4) locational criteria for the evaluation of rezones to the L3 and L4 designations inside of urban villages shall not apply in the Morgan Junction Residential Urban Village.
- MJ-P16** Strive to achieve adequate levels of parking for new commercial, mixed-use and multifamily buildings, and use other parking management techniques that minimize spillover parking into residential areas.
- MJ-P17** Encourage parking standards for new multifamily development that reflect the ratio of vehicle ownership per multifamily dwelling unit in Morgan Junction.
- MJ-P18** Encourage parking standards for new development that reflect the proportion of compact cars registered in the City of Seattle, based on Washington Department of Licensing data.
- MJ-P19** Explore methods to discourage increasing height limits in the commercial and multifamily zones above the currently existing levels and encourage developers of new multifamily and commercial buildings to locate mechanical, heating, ventilation, and air conditioning equipment within the envelope of the building structure.

MORGAN JUNCTION Residential Urban Village

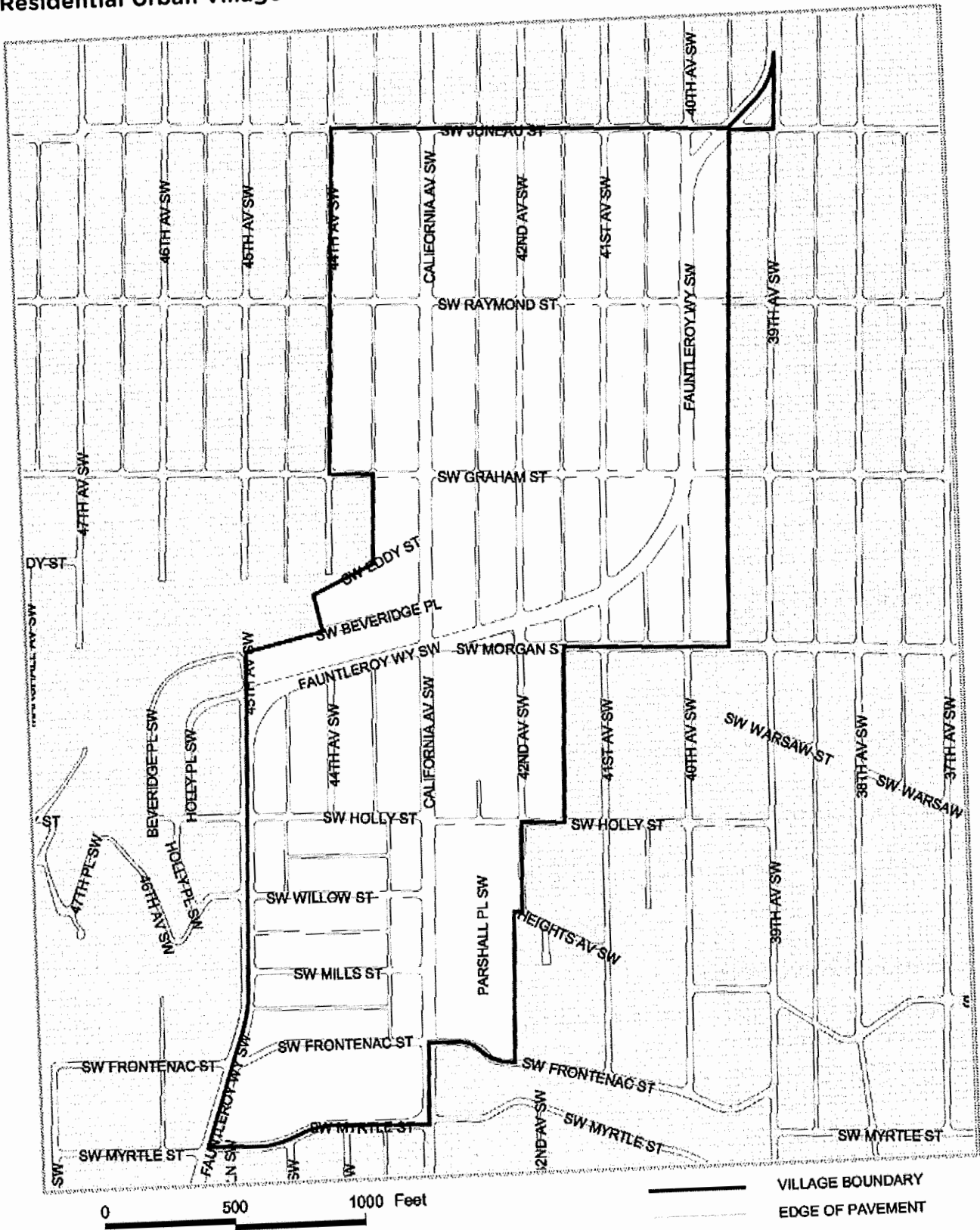

- MJ-P20** Support and promote existing programs and policies that help low- and fixed-income people, especially seniors, retain ownership of their homes.
- MJ-P21** Encourage the preservation of well-managed low-income housing both inside and outside the urban village.
- MJ-P22** Promote homeownership for people of diverse backgrounds and income levels, and encourage a wide range of building styles.
- MJ-P23** As provided in citywide Comprehensive Plan housing policy, and as implemented through the City's Consolidated Plan, consider the proximity of existing publicly supported housing to the Morgan Junction Urban Village when considering the location of additional publicly supported housing.

COMMUNITY & CULTURE GOAL

- MJ-G6** A community that has a distinctive flavor in arts and culture, yet integrates with the overall arts and culture community in West Seattle.

COMMUNITY & CULTURE POLICIES

- MJ-P24** Support the provision of public art throughout the business district and in new public spaces.
- MJ-P25** Seek opportunities to develop public gathering spaces.
- MJ-P26** Encourage human services providers to work closely with neighborhood organizations in coordinating programs that benefit consumers and the larger community.
- MJ-P27** Strive to improve library services to better serve the Morgan Junction community.
- MJ-P28** Support community activities for children, teens, and families.

PUBLIC SAFETY GOAL

- MJ-G7** A safe community with active crime-prevention programs and a strong police presence.

PUBLIC SAFETY POLICIES

- MJ-P29** Use the new SW Police Precinct to improve public safety services in Morgan Junction.
- MJ-P30** Promote the use of Crime Prevention Through Environmental Design (CPTED) techniques in the development of new open space sites, pedestrian trails, and traffic improvements.

MJ-P31 Seek to improve communication between individuals, organizations, and communities dealing with safety issues.

MJ-P32 Strive to provide responsive solutions to address public safety service issues as identified by neighborhood groups.

CAPITAL FACILITIES GOAL

MJ-G8 A neighborhood with public facilities that are assets to both the neighborhood and community activities.

CAPITAL FACILITIES POLICIES

MJ-P33 Seek to involve the Morgan Junction community in planning efforts for the use of public facilities in the planning area.

MJ-P34 Encourage the maintenance and continued use of public facilities as necessary to ensure they remain assets to the neighborhood and preserve their historic value.

MJ-P35 Encourage the retention and re-use of public facilities within the Morgan Junction neighborhood that would serve long-term goals and needs of the community.

North Beacon Hill

LAND USE & HOUSING GOAL

NBH-G1 A well-defined mixed-use residential neighborhood where the lives of Beacon Hill residents are enhanced, in part, through affordable and diverse housing options available throughout the neighborhood.

NBH-G2 A vibrant mix of housing close to the light rail station.

LAND USE & HOUSING POLICIES

NBH-P1 Encourage sensitive transitions between development densities throughout the urban village, in particular between the town center and surrounding residential areas.

NBH-P2 To enable any implementation of rezoning to be considered under Policy P1, that portion of Beacon Avenue South located within the boundaries of the North Beacon Hill Residential Urban Village is designated a principal commercial street.

NBH-P3 Encourage a mix of unit prices and sizes through active use of incentives, direct City funding, and surplus property programs.



- NBH-P4** Encourage affordable, family-sized homes through incentives, direct City funding, and surplus property programs. In particular, strive to preserve, or when needed, replace affordable family-sized apartments.
- NBH-P5** Encourage a balance of affordable rental and homeownership housing through incentives, direct City funding, and surplus property programs.
- NBH-P6** Encourage the development of housing close to the light rail station.
- NBH-P7** Capture the opportunity created by light rail to support affordable housing development close to the light rail station by including homes appropriate for different family sizes, so that residents are able to stay in the neighborhood, even as the housing market changes over time.
- NBH-P8** Seek to maintain the character of low-density multifamily areas in the northern portion of the urban village while providing opportunities for additional mixed-use residential development in the retail core in the southern portion of the urban village.
- NBH-P9** Allow alternative housing types, such as cottage housing, in single-family zones to support affordable choices while preserving the single-family character.
- NBH-P10** Support a continuing mix of small businesses and encourage new small businesses by providing technical assistance and access to financing.

TOWN CENTER GOALS

- NBH-G3** A civic gathering space appropriate and flexible for the diversity of cultures living in the neighborhood.
- NBH-G4** An urban village with a strong overall business district image and identity that is home to a variety of commercial services, including a grocery store and a mix of small, local, and ethnic businesses.
- NBH-G5** Higher-density development surrounds the light rail station and is responsive to the neighborhood context at a variety of scales, from single-family houses to multistory buildings.
- NBH-G6** A redevelopment of El Centro de la Raza that builds on the site's history and serves as a defining civic element of the town center.
- NBH-G7** A Town Center urban form that transitions from denser development at the Town Center core to less dense and single-family residential neighborhoods in a manner that is responsive to the context and character of the North Beacon Hill neighborhood.

TOWN CENTER POLICIES

- NBH-P11** Retain local access to food, including a grocery store in the commercial core.

- NBH-P12** Promote services, such as childcare, that can serve neighborhood residents who commute by light rail, close to the station.
- NBH-P13** Preserve and support the expansion of the role of El Centro as a cultural and service center, including current social services such as childcare and a food bank.
- NBH-P14** Support a multicultural gathering venue.
- NBH-P15** Support mixed-use development on the El Centro site through appropriate zoning or regulatory changes.
- NBH-P16** Recognize the importance of the library as a focal point for a community with an ethnically diverse population, a significant number of whom are young, and its role as a symbol of pride and identity.
- NBH-P17** Guide future development and potential rezones so they contribute to an urban form and character at the town center that is responsive to the North Beacon Hill vision.

PUBLIC SAFETY GOAL

- NBH-G8** North Beacon Hill is an active and safe neighborhood for a diversity of people, throughout the day and evening.

PUBLIC SAFETY POLICY

- NBH-P18** Encourage additional eyes on the street over the course of the day and evening through community programs and festivals, the design of new developments, and other means.

TRANSPORTATION: PEDESTRIAN IMPROVEMENTS GOAL

- NBH-G9** An urban village that is a pleasant place to walk with good access to alternative transportation, where lively, friendly, and safe streetscapes encourage pedestrians and bicyclists, and where roadways are seen as public access for walkers, bicycles, and buses as well as cars.

TRANSPORTATION: PEDESTRIAN IMPROVEMENTS POLICIES

- NBH-P19** Enhance pedestrian safety along key streets within the urban village and discourage projects that would hinder pedestrian access.
- NBH-P20** Seek improvements, such as crosswalks, pedestrian-activated crossing signals, signage, curb bulbs or other devices that will improve pedestrian safety along Beacon Avenue South, and that support increased access to shopping and transit.
- NBH-P21** Provide for improved and safe pedestrian access to the North Beacon Hill Library through the design of surrounding streets and walkways.



TRANSPORTATION: TRANSIT SERVICE GOALS

- NBH-G10 An urban village with transit service that serves the needs of the existing population and also provides for improvements to serve the neighborhood's projected population growth.
- NBH-G11 An urban village with an established neighborhood station and transit linkages to all other alternative transit modes available.

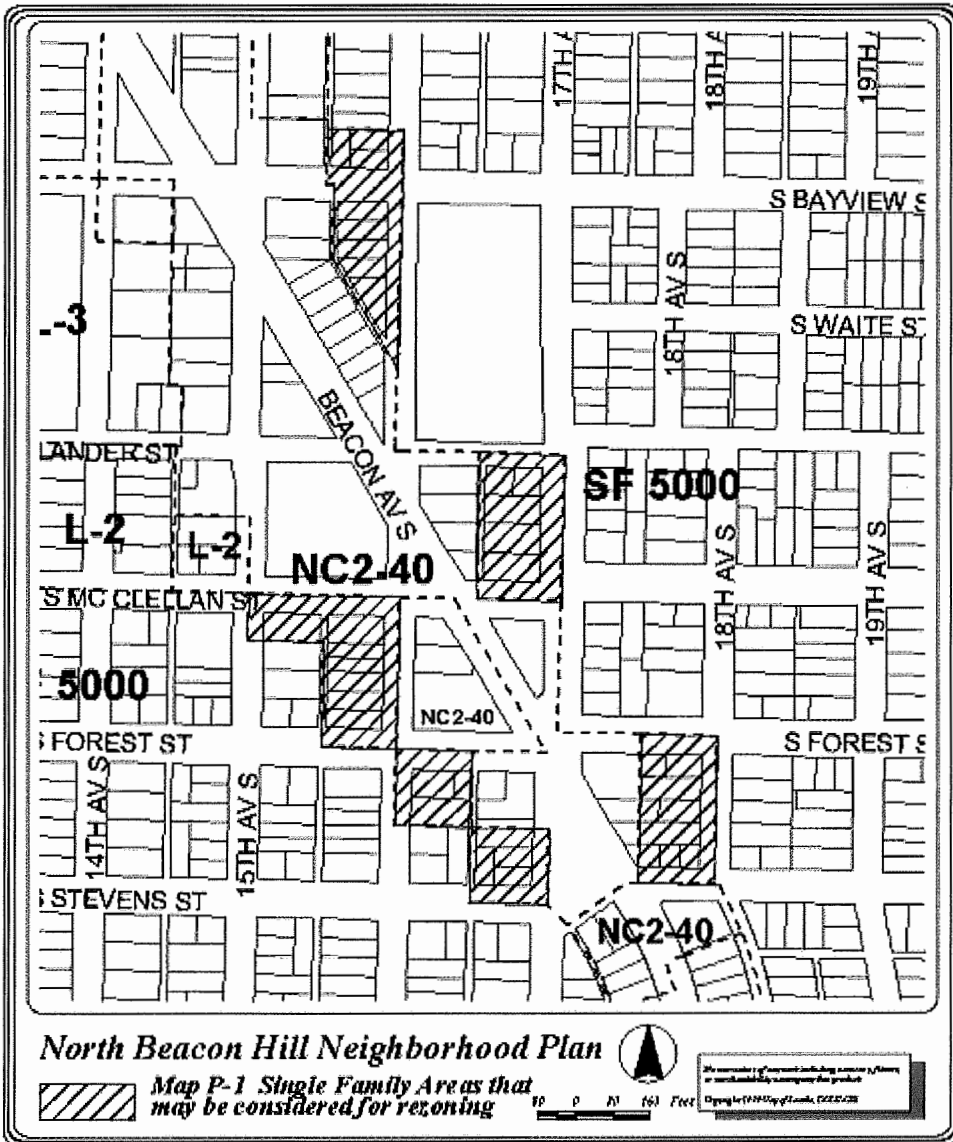

NORTH BEACON HILL Residential Urban Village

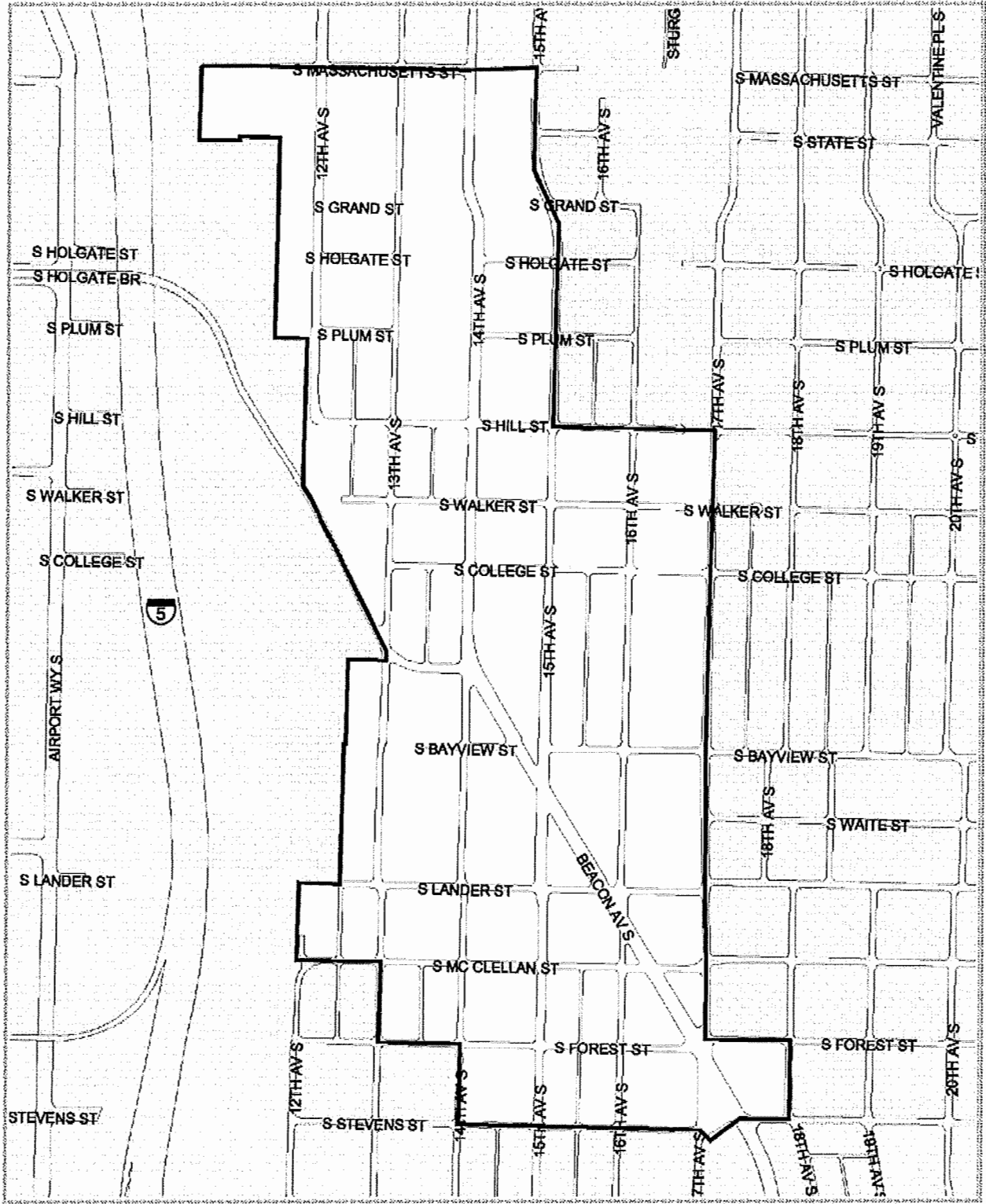

0 500 1000 Feet

— VILLAGE BOUNDARY
— EDGE OF PAVEMENT



TRANSPORTATION: TRANSIT SERVICE POLICIES

- NBH-P22** Recognize the current high levels of transit ridership within North Beacon Hill and support improvements to transit systems to encourage continued transit ridership and less reliance on the automobile.
- NBH-P23** Strive to improve transit connections within Beacon Hill and to and from other neighborhoods to create a seamless transportation network for the neighborhood.
- NBH-P24** Support the effort by King County Metro Transit to improve the transit system in and around Beacon Hill.

TRANSPORTATION: TRAFFIC-CALMING GOALS

- NBH-G12** A residential urban village in which neighborhood traffic functions efficiently and safely and in which traffic-calming devices that improve pedestrian safety are placed at strategic locations.
- NBH-G13** Recognition of the link Beacon Avenue Boulevard provides through the entire neighborhood planning area.

TRANSPORTATION: TRAFFIC-CALMING POLICIES

- NBH-P25** Recognize the existing residential character of many streets within the urban village and support mechanisms to protect these streets from increased traffic.
- NBH-P26** Strive to implement neighborhood traffic-calming control devices and strategies that protect local residential streets from through-traffic, short-cutting, high volumes, and high-speed traffic as growth occurs within the urban village.
- NBH-P27** Recognize the unique topography and location of North Beacon Hill and its connections to major arterials, freeway access points, and sports-stadium destinations and seek ways to mitigate the resulting traffic impacts on residential street systems.
- NBH-P28** Recognize the unique conditions along Beacon Avenue as it cuts diagonally across the regular north-south and east-west street grid and creates irregular intersections and difficulties for pedestrian crossings.
- NBH-P29** Use the Pedestrian Master Plan, which recognizes the importance of Beacon Avenue South, to identify and prioritize pedestrian improvements.
- NBH-P30** Use the Bicycle Master Plan, which recognizes the importance of Beacon Avenue South, to identify, prioritize, and improve bicycle connections to Downtown, Jefferson Park, and Rainier Valley.
- NBH-P31** Encourage improvements on Beacon Avenue that enhance its functional use and physical appearance.



OPEN SPACE & URBAN DESIGN GOALS

- NBH-G14** An urban village that provides open space amenities and utilizes design guidelines for future development that benefits the neighborhood and contributes to a livable environment.
- NBH-G15** A range of well-maintained parks and community open spaces in the urban village core with programs that accommodate a diversity of uses and users.

OPEN SPACE & URBAN DESIGN POLICIES

- NBH-P32** Seek to create additional public open space amenities within the urban village through future public acquisition and encourage the inclusion of public open space in private development.
- NBH-P33** Recognize that public streets are part of the open space network within the urban village and strive to improve the physical character and quality of the key pedestrian streets.
- NBH-P34** Consider the development of pedestrian and bicycle trails through publicly owned greenbelts throughout North Beacon Hill.
- NBH-P35** Develop, through public programs and public/private partnerships, at key locations within the commercial core along Beacon Avenue, small civic open spaces, gateways, landscaped features, and pedestrian streetscape amenities.

PARKS & RECREATION GOAL

- NBH-G16A** neighborhood with parks that serve the needs of both regional and local users.

PARKS & RECREATION POLICIES

- NBH-P36** Explore and support opportunities to increase usable open space in parks that serve the neighborhood, including Jefferson Park.
- NBH-P37** Seek to create small pocket parks throughout the urban village, either through City acquisition or private development.
- NBH-P38** Continue to develop neighborhood-specific cultural programming and design elements in Seattle's parks.
- NBH-P39** Seek to preserve scenic views from parks located within the neighborhood.
- NBH-P40** Encourage opportunities for public art within the neighborhood's parks.

North Neighborhoods (Lake City)

GETTING AROUND GOAL

NN-GA1 A comprehensive multi-use, neighborhood-oriented transportation network integrates with regional and intra-city transportation systems and services.

GETTING AROUND POLICIES

- NN-P1** Reduce the impact of cut-through traffic in neighborhoods and use neighborhood input in selecting and designing mitigation measures.
- NN-P2** Strive to create safe pedestrian ways, especially for children walking between schools and transit stops on Lake City Way, NE 125th Street, and 15th Avenue NE.
- NN-P3** Improve access from residential neighborhoods to the Civic Core and the business district.
- NN-P4** Enhance opportunities for nonmotorized travel in the planning area, tailoring pedestrian improvements to neighborhood desires, community needs, and topographic and environmental considerations.
- NN-P5** Require installation of curbs, gutters, and sidewalks as part of any new multifamily or commercial development in the planning area along both residential and arterial streets that meets threshold standards established in the City's Street Improvement Manual. Encourage the installation of sidewalks, curbs, gutters, and sidewalk lighting for any new or substantially renovated multifamily or commercial development in the planning area along both residential and arterial streets.

LAKE CITY WAY GOAL

NN-LCW1 Lake City Way has a pleasant, safe "boulevard" look and feel that accommodates both local and through-traffic and transit as well as pedestrian use.

LAKE CITY WAY POLICIES

- NN-P6** Along Lake City Way, seek to redesign driveway access where safety problems exist.
- NN-P7** Minimize the dividing effect of Lake City Way on the business district and the community.
- NN-P8** Establish a pedestrian-friendly atmosphere and boulevard look and feel for Lake City Way.
- NN-P9** In conjunction with maintenance or improvements to Lake City Way, seek to preserve, repair, or re-establish adjacent riparian and wetland systems.

NN-P10 Using neighborhood input, develop bike routes through the planning area to eliminate the need for bicyclists to travel on Lake City Way.

CIVIC CORE GOAL

NN-CC1 A cluster of public community facilities is conveniently located and serves the area's projected population.

CIVIC CORE POLICIES

NN-P11 Consider colocation, consolidation, and expansion of community facilities and property.

NN-P12 Provide walking and biking paths inside and to the Civic Core.

BUSINESS, ECONOMIC DEVELOPMENT GOAL

NN-BED1 New businesses and employers are attracted to the Lake City business district and new private commercial investment is stimulated.

BUSINESS, ECONOMIC DEVELOPMENT POLICIES

NN-P13 Provide infrastructure that will support current business and residential population as well as future growth.

NN-P14 Strive to underground utilities when sidewalk and street improvements are made within the planning area.

NN-P15 Support and encourage home-based businesses in residential areas while protecting the neighborhood character.

COMMUNITY NETWORKS GOAL

NN-CN1 Opportunities exist for effective civic involvement by individuals and organizations throughout the planning area.

COMMUNITY NETWORKS POLICIES

NN-P16 Maintain the open and inviting character of community councils and the North District Council so people and organizations of the planning area will feel encouraged toward civic participation.

NN-P17 Build on existing programs and resources, creating new programs or efforts only to fill gaps that existing programs and resources cannot provide.

PUBLIC SAFETY & CRIME PREVENTION GOAL

NN-PSCP1 A perception and reality of security and safety exists throughout the planning area.

PUBLIC SAFETY & CRIME PREVENTION POLICIES

NN-P18 Support programs and facilities that effectively address the causes of crime and prevent crime and public safety problems.

NN-P19 Use design standards to provide safe pedestrian and bicycle travel.

NN-P20 Use environmental design techniques and guidelines to reinforce crime prevention.

NN-P21 Provide appropriate levels of police and fire protection to all places within the planning area.

NN-P22 Seek to identify and remedy known crime problems as they develop.

NATURAL SYSTEMS GOAL

NN-NS1 The area's watershed, green areas, and habitat corridors are preserved and improved.

NATURAL SYSTEMS POLICIES

NN-P23 Strive to avoid the degradation of natural systems.

NN-P24 Strive to avoid land use actions that negatively affect sensitive ecosystems and natural systems. When avoidance is not possible, employ effective natural mitigation methods and try to find ways to take protective measures.

NN-P25 Encourage and support businesses and industries that employ sound environmental practices.

OPEN SPACES GOAL

NN-OS1 Parks, public recreation facilities, and community areas are safe, clean, multi-use wherever possible, and responsive to local needs.

OPEN SPACES POLICIES

NN-P26 Support the provision of usable open space at one-half mile intervals.

NN-P27 Act cooperatively with community councils, neighborhoods, appropriate City departments, and the Seattle school district in the development of joint-use or other types of cooperative agreements.

**LAKE CITY
Hub Urban Village**

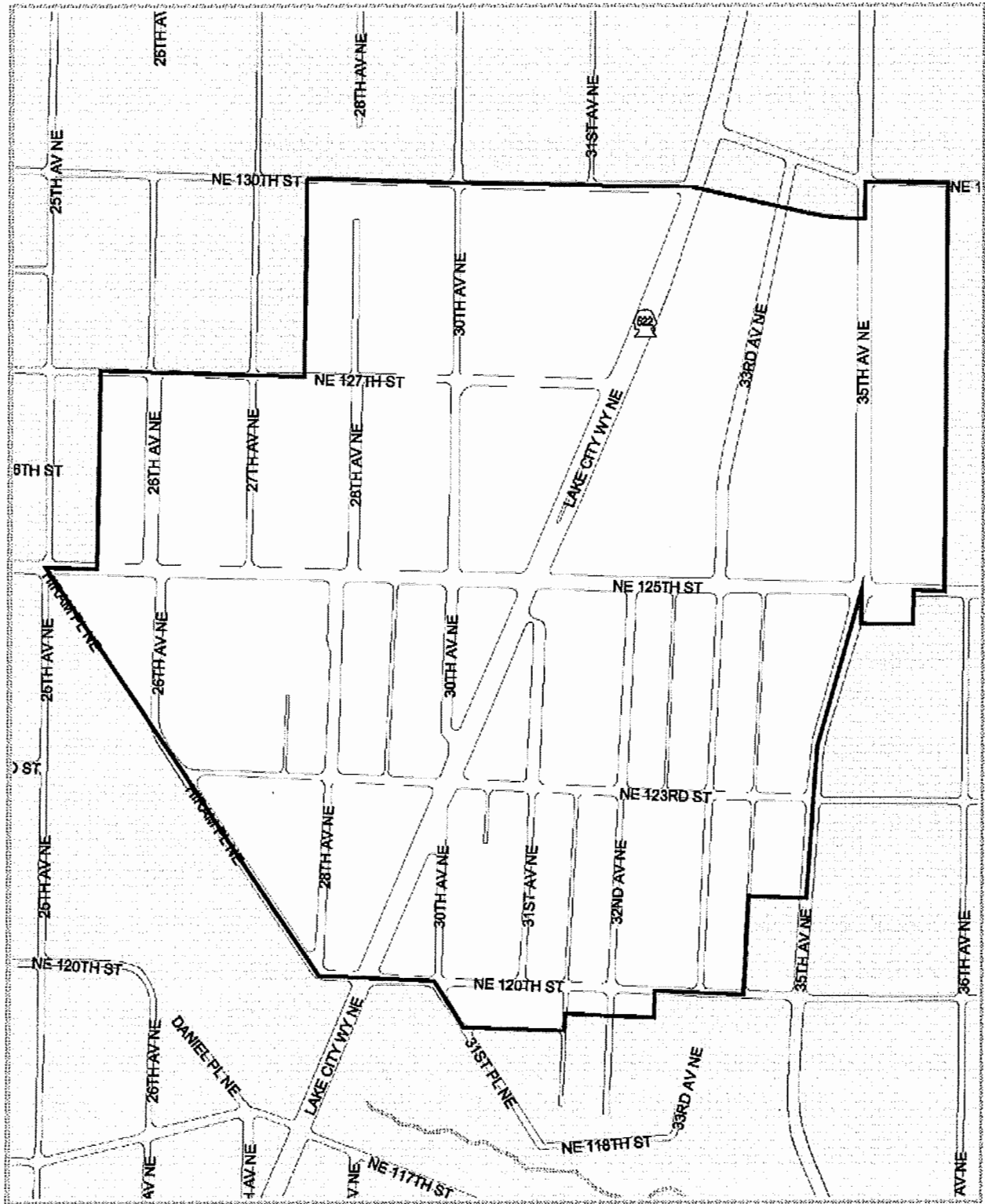

0 500 1000 Feet

VILLAGE BOUNDARY
EDGE OF PAVEMENT

- NN-P28** Foster mutual support and reciprocity by urging schools in the planning area to proactively seek partnership with neighborhood residents and community councils.
- NN-P29** Encourage the development of transit-connection waiting areas and access routes that are safe, pleasant, and augment open space resources.
- NN-P30** Encourage the inclusion of publicly accessible gathering areas or provide for such areas in a nearby location in developments of one block or larger size.
- NN-P31** Encourage the inclusion of rooftop and/or common area courts devoted to green open space and/or children’s play areas in multifamily developments of six or more family units.
- NN-P32** Strive to make all parks and public gathering spaces ADA accessible.

HUB URBAN VILLAGE GOAL

- NN-HUV1** A unique urban area fosters business vitality, sense of community, and strong connections to surrounding neighborhoods and businesses.

HUB URBAN VILLAGE POLICIES

- NN-P33** Support the use of regulatory tools, including zoning, that promote vibrant, pedestrian-oriented development.
- NN-P34** New multifamily housing in commercial zones within pedestrian-designated zones in the HUV will be mixed-use, with a nonresidential use on the street-level.
- NN-P35** Encourage new development in the HUV to include adequate provision for the needs of pedestrians.

HOUSING DEMAND GOAL

- NN-HD1** Mixture of high-quality housing exists and the established residential areas are protected from encroachment by, and impacts of, other uses.

HOUSING DEMAND POLICIES

- NN-P36** Encourage development of non-single-family parcels adjacent to single-family zoning to provide transitions or buffers adequate to protect the single-family area from adverse impacts.
- NN-P37** Encourage innovative and affordable housing types responsive to market demand and neighborhood desires, including live-work, studio, and in-home business.
- NN-P38** This policy is to be considered in the review of future rezones in the area defined by 15th Avenue NE on the west, NE 95th Street on the south, NE 145th Street on



the north, and Lake Washington on the east. Rezones are not favored by this neighborhood plan if they would:

- increase the permitted density, bulk, or height of structures in residential or commercial use, except for rezones from a commercial (C) zone to a neighborhood commercial (NC) zone or any rezone in the vicinity of the Civic Core, defined as the area roughly bounded by 128th Avenue NE on the north, Lake City Way on the east, 30th Avenue NE and 125th Street to the south, and 27th Avenue NE to the west;
- change a neighborhood commercial (NC) to a commercial (C) zone; or
- change a commercial to an industrial zone.

This policy shall not apply to rezones proposed in close proximity to a high-capacity transit station outside of the urban village. Any rezone should be done in cooperation with the community.

HUMAN SERVICES GOAL

NN-HS1 Human services serve current and future populations.

HUMAN SERVICES POLICIES

NN-P39 Seek to acquire land for capital facilities and other resources in anticipation of population growth, based on demographic projections.

NN-P40 Periodically assess the effectiveness of current services through means such as community reviews or performance audits.

DESIGN REVIEW GOAL

NN-DR1 Significant community influence over the quality, function, and appearance of future development is accomplished through effective use of design review guidelines.

DESIGN REVIEW POLICIES

NN-P41 Require design review for all multifamily and commercial development meeting Design Review Program thresholds, in the zones to which the Design Review Program applies, anywhere in the North Neighborhoods' planning area.

NN-P42 Seek to protect existing riparian and wetland areas and re-establish interrupted systems.

NN-P43 Seek to provide clear, safe separation of pedestrian and vehicular areas on all arterials and within the HUV.

NN-P44 Provide amenities along sidewalks that are attractive and safe.



North Rainier

TOWN CENTER GOAL

- NR-G1** A town center that concentrates housing, commercial uses, services and living-wage employment opportunities; that is well served by transit and nonmotorized travel options; and that is well-designed and attractive to pedestrians.

TOWN CENTER POLICIES

- NR-P1** Recognize the town center as the area where land use designations facilitate transit-oriented development to promote appropriate development around the light rail station.
- NR-P2** Foster development of a shopping district composed of businesses that provide products and services meeting the needs of community members from different cultural backgrounds.
- NR-P3** Promote uses around transit facilities such as businesses open into the evening hours, and housing that provides “eyes on the street.”
- NR-P4** Encourage the construction of physical improvements and activity programming that are culturally relevant to people with disabilities throughout the town center.
- NR-P5** Provide sufficient utility capacity within the town center to support the desired future density.
- NR-P6** Within mixed-use zones in the Station Area Overlay District, define and consider minimum residential densities in new buildings in order to create the critical mass of people and activity for a town center.

HOUSING GOALS

- NR-G2** Housing in the neighborhood meets community needs for a range of household incomes and unit sizes, and makes a compatible transition from higher-intensity mixed-use and multifamily residential to single-family areas.
- NR-G3** Development within the town center prioritizes housing that serves households across a range of incomes.

HOUSING POLICIES

- NR-P7** Seek to promote the highest intensity residential development in the proposed town center, the focal point of mixed-use commercial and residential development.
- NR-P8** Encourage additional multifamily or mixed-use development in the following areas: south of the Rainier/Martin Luther King intersection within the urban village, and

continue south toward Rainier Valley Square Shopping Center; and in vacant parcels located east to 23rd Avenue South and west to 17th Avenue South around the intersection of Massachusetts Street and Rainier Avenue South.

- NR-P9** Seek to maintain single-family zoned areas within the urban village, but allow rezones to Residential Small Lot to encourage cluster housing developments and bungalow courts. Any single-family-zoned area within the urban village is appropriate for any of the small-lot single-family designations, provided that the area meets other requirements of the land use code rezone evaluation criteria for rezones of single-family land.
- NR-P10** Include a portion of single-family area located between 24th Avenue South and 25th Avenue South, north of S. McClellan Street, within the urban village and within the Station Area Overlay District, and support a multifamily zoning designation for the area that would allow more compact residential development.
- NR-P11** Seek partnerships with local social service providers, and continue to develop programs such as down payment assistance to develop affordable and attractive homeownership opportunities in the North Rainier Valley.
- NR-P12** Use design guidelines within the North Rainier Hub Urban Village so that higher-density development includes well-designed structures that respond to the desired future physical character and existing positive attributes of the surrounding natural environment and the neighborhood.
- NR-P13** Encourage a mix of home prices and sizes through active use of incentives and funding.

ECONOMIC DEVELOPMENT GOALS

- NR-G4** A vibrant business district that serves North Rainier residents and is a destination shopping area with stores that serve the greater Rainier Valley.
- NR-G5** The neighborhood retains sufficient zoning capacity to facilitate employment growth.
- NR-G6** A local economic climate in which North Rainier's unique small businesses can remain economically viable, and have the opportunity to grow as the town center grows.
- NR-G7** North Rainier Hub Urban Village is known as a "green hub" providing green jobs and training, and green development.

ECONOMIC DEVELOPMENT POLICIES

- NR-P14** Seek to maintain the general commercial zoning that is outside the proposed town center in order to provide a land supply that promotes higher-wage manufacturing, distribution, and office and professional employment.

- NR-P15** In fulfilling its role as the hub urban village for the Rainier Valley, North Rainier should include training programs and jobs for youth that prepare them for family-wage jobs in the area and region.
- NR-P16** Strive to facilitate the vitality of existing retail and businesses that help meet the neighborhood's employment goals and serve as destination businesses for customers from the Rainier Valley and beyond in addition to meeting the daily needs of residents.
- NR-P17** Provide technical and financial support to small business that meet the needs of the ethnic and cultural businesses in the neighborhood.
- NR-P18** Strengthen local business associations that include and support the presence and growth of businesses owned by immigrant and minority community members.
- NR-P19** Support and expand the existing diverse mix of generally small-scale businesses.
- NR-P20** Encourage the inclusion of affordable commercial space in new development.
- NR-P21** Support training programs and jobs in North Rainier that capitalize on the green technology market in order to support the role of North Rainier as the hub urban village within the Rainier Valley.
- NR-P22** Identify and promote opportunities for green infrastructure and development.

COMMUNITY LIFE GOALS

- NR-G8** North Rainier Valley's network of parks, recreational facilities, open spaces, and arts and culture programs are functioning and are well utilized.
- NR-G9** Ethnic and cultural diversity is a continued presence in the businesses and community.
- NR-G10** A community that supports and provides opportunities for neighborhood youth.
- NR-G11** The transportation and housing needs of residents of North Rainier's community service facilities are met.
- NR-G12** North Rainier is known as a safe and hospitable neighborhood through its residents' increased awareness of community-based crime prevention programs.

COMMUNITY LIFE POLICIES

- NR-P23** Enhance community pride through establishment of a multicultural community center, multicultural community festivals, mentoring, and programs that support positive and safe activities for youth.
- NR-P24** Promote the location of cultural community centers and services in the transit-accessible areas of the neighborhood.



NORTH RAINIER Hub Urban Village

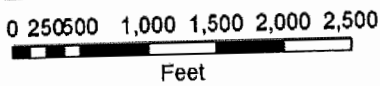
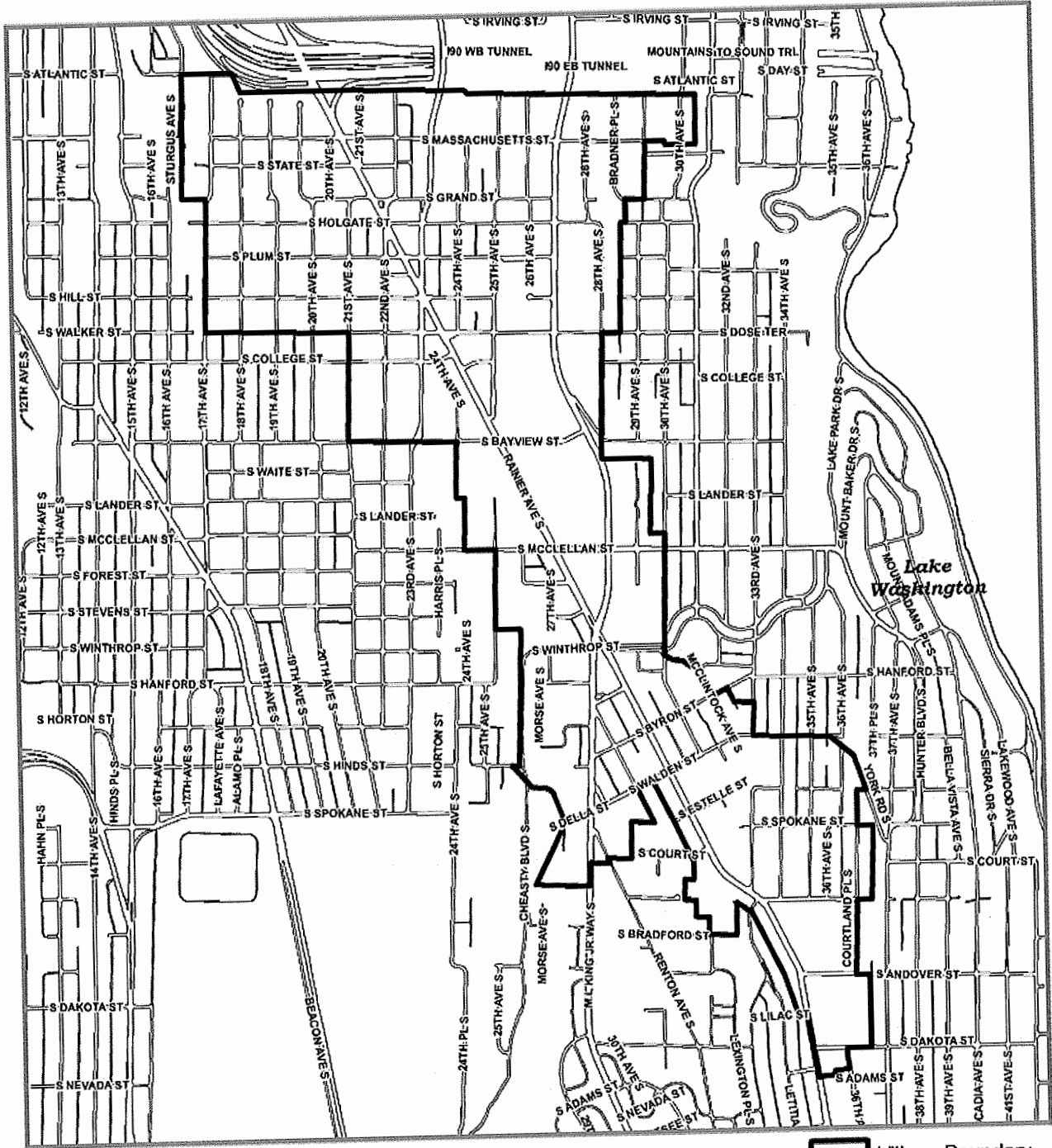

- Village Boundary
- Edge of Pavement

- NR-P25** Support local agriculture and access to locally grown food through public mechanisms such as P-Patches and the Cultivating Communities program, as well as nonprofit and private mechanisms including farmers' markets and on-site landscaping.
- NR-P26** Seek to meet the transit, access, and housing needs of users of North Rainier's community service facilities.
- NR-P27** Encourage housing and employment opportunities for people with special needs.
- NR-P28** Encourage community-based efforts for cross-cultural integration among the business owners as well as among the broader community.
- NR-P29** Seek ways to enhance North Rainier's built environment through actions such as neighborhood-wide clean-ups and "adopt-a-street" programs, rehabilitation and reuse of old or historic buildings, and through reclaiming public land for public use (i.e., street ends, planting strips, and City-owned vacant lots and buildings).
- NR-P30** Seek opportunities for the community and the Seattle Police Department to strengthen partnerships.
- NR-P31** Seek to promote community improvement projects that can be acted upon through community-based efforts, as well as through public investment.

OPEN SPACE GOAL

- NR-G13** Cheasty Boulevard and Greenbelt has been reclaimed and developed in a manner consistent with the 1909 Olmsted Parks and Boulevards Plan.
- NR-G14** A "ring of green" surrounding the urban village with strong connections to the greenbelts, boulevards, and parks, augmented with a hierarchy of open spaces.

OPEN SPACE POLICIES

- NR-P32** Support partnerships with Parks, SDOT, DON, utilities, nonprofits, and the community to enhance street-end stairs, and create safe trails where appropriate through the surrounding greenbelts.
- NR-P33** Design parks and open spaces and programming to accommodate users of diverse ages, interests, and cultures.
- NR-P34** Consider using levy funds, general funds, and partnerships with developers, to create a hierarchy of public and private open spaces that are publicly accessible and address the gaps identified in the Parks Gap Analysis.
- NR-P35** Seek to preserve environmentally sensitive hillsides, particularly those in the Cheasty Greenbelt, and seek to protect them from further residential development.



TRANSPORTATION & TRANSIT SERVICE GOALS

- NR-G15** Good connections between North Rainier Valley, Mount Baker, and Beacon Hill that encourage use of the Link Light Rail station.
- NR-G16** Neighborhoods adjacent to Rainier Avenue South and Martin Luther King Jr. Way have effective traffic circulation and have implemented traffic-calming strategies/facilities.
- NR-G17** A neighborhood served by a network of safe streets with amenities for pedestrians and bicyclists.
- NR-G18** Rainier Avenue South is a highly functioning multimodal “complete street” that serves as the spine of the Rainier Valley and retains its existing vistas of Mount Rainier.
- NR-G19** Continue to develop Martin Luther King Jr. Way South as a “complete street,” and part of the neighborhood’s network of streets with amenities for pedestrians, bicyclists, and transit riders.
- NR-G20** A transformed Rainier Avenue South between South Bayview Street and Martin Luther King Jr. Way South that functions as a pedestrian-oriented main street.

TRANSPORTATION & TRANSIT SERVICE GOALS

- NR-P36** Promote alternative transportation programs, such as bicycle commuting, local hiring, van pools, and transit ridership.
- NR-P37** Create seamless pedestrian and bicycle links within the town center, and to the surrounding community facilities.
- NR-P38** Prioritize development of universally accessible routes between the town center and locations such as Lighthouse for the Blind and Center Park.
- NR-P39** Ensure that standards for new development projects will accommodate a vibrant pedestrian environment throughout the town center.
- NR-P40** Enhance access throughout the town center for people of all ages and abilities.
- NR-P41** Support actions that improve the pedestrian and transit functions along Rainier Avenue South between South Bayview Street and Martin Luther King Jr. Way South so that the section becomes more of a local main street for the North Rainier neighborhood.



Northgate

GOALS

- NG-G1** A place where people live, work, shop, play, and go to school—all within walking distance.
- NG-G2** A thriving, vital, mixed-use center of concentrated development surrounded by healthy single-family neighborhoods transformed from an underutilized, auto-oriented office/retail area.

LAND USE & HOUSING GOALS

- NG-G3** The surrounding single-family neighborhoods are buffered from intense development in the core, but have ready access to the goods, services, and employment located in the core via a range of transportation alternatives including walking, bicycling, transit, and automobile (the core area is shown on the Northgate map).
- NG-G4** The most intense and dense development activity is concentrated within the core.
- NG-G5** Commercial activity outside the core is smaller in scale and allows for a mix of uses that serve the adjacent residential neighborhoods.

LAND USE & HOUSING POLICIES

- NG-P1** Encourage development of the core as a major regional activity center for retail, commercial, office, multifamily residential, and educational uses with densities sufficient to support transit.
- NG-P2** Use land use regulation to cause new development to locate close to transit stops and provide good pedestrian and bicycle connections throughout the area so that intra-area vehicular trips and locally generated traffic are reduced.
- NG-P3** Use a Northgate Overlay District to address the special characteristics of development in the area.
- NG-P4** Concentrate employment activity where the infrastructure and transportation system can best accommodate it.
- NG-P5** Promote a mixture of activities including commercial and residential uses in areas that have Neighborhood Commercial and Residential Commercial zoning designations.
- NG-P6** Promote additional multifamily housing opportunities for households of all income levels to the extent that a compatible scale and intensity of development can be maintained with adjacent single-family areas.

- NG-P7** Reduce conflicts between activities and promote a compatible relationship between different scales of development by maintaining a transition between zones where significantly different intensities of development are allowed.
- NG-P8** Maintain the character and integrity of the existing single-family zoned areas by maintaining current single-family-zoning on properties meeting the locational criteria for single-family zones.
- NG-P8.5** Support future potential rezones to higher-intensity designations in the North Core Subarea. In considering such rezones, pay particular attention to the development of an environment that creates a network of pedestrian connections and that encourages pedestrian activity, among other considerations associated with a rezone review.

TRANSPORTATION GOALS

- NG-G6** An economically viable commercial core with improved alternative means of access, good vehicular and pedestrian circulation, and an enhanced, interesting environment that attracts customers, visitors, and employers.
- NG-G7** Medium- to high-density residential and employment uses are concentrated within a ten-minute walk of the transit center, reducing the number and length of vehicle trips and making travel by foot and bicycle more attractive.

TRANSPORTATION POLICIES

- NG-P9** Promote the efficiency of the transportation system by accommodating more person trips rather than vehicle trips.
- NG-P10** Enhance transit service and facilities to make it a more attractive travel mode for people living and working in the Northgate Area.
- NG-P11** Promote pedestrian circulation with an improved street-level environment by striving to create pedestrian connections that are safe, interesting, and pleasant.
- NG-P12** Manage parking supply, location, and demand to discourage the use of single-occupant vehicles, and to improve short-term parking accessibility for retail customers, patients, and visitors, without undermining transit or high-occupancy vehicle (HOV) usage, or detracting from the creation of an attractive pedestrian environment.
- NG-P13** Seek to reduce the impact of increases in traffic volume by limiting conflicts with local access streets, and improving traffic flow, circulation and safety, without increasing vehicular capacity.
- NG-P14** Seek to control impacts of a high-capacity transit station on surrounding neighborhoods by emphasizing nonmotorized access, transit-supportive land uses, and an attractive pedestrian environment at and near the station.



NORTHGATE

Map of the North Core Area within the Northgate Urban Center and Overlay District

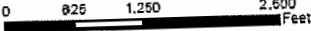
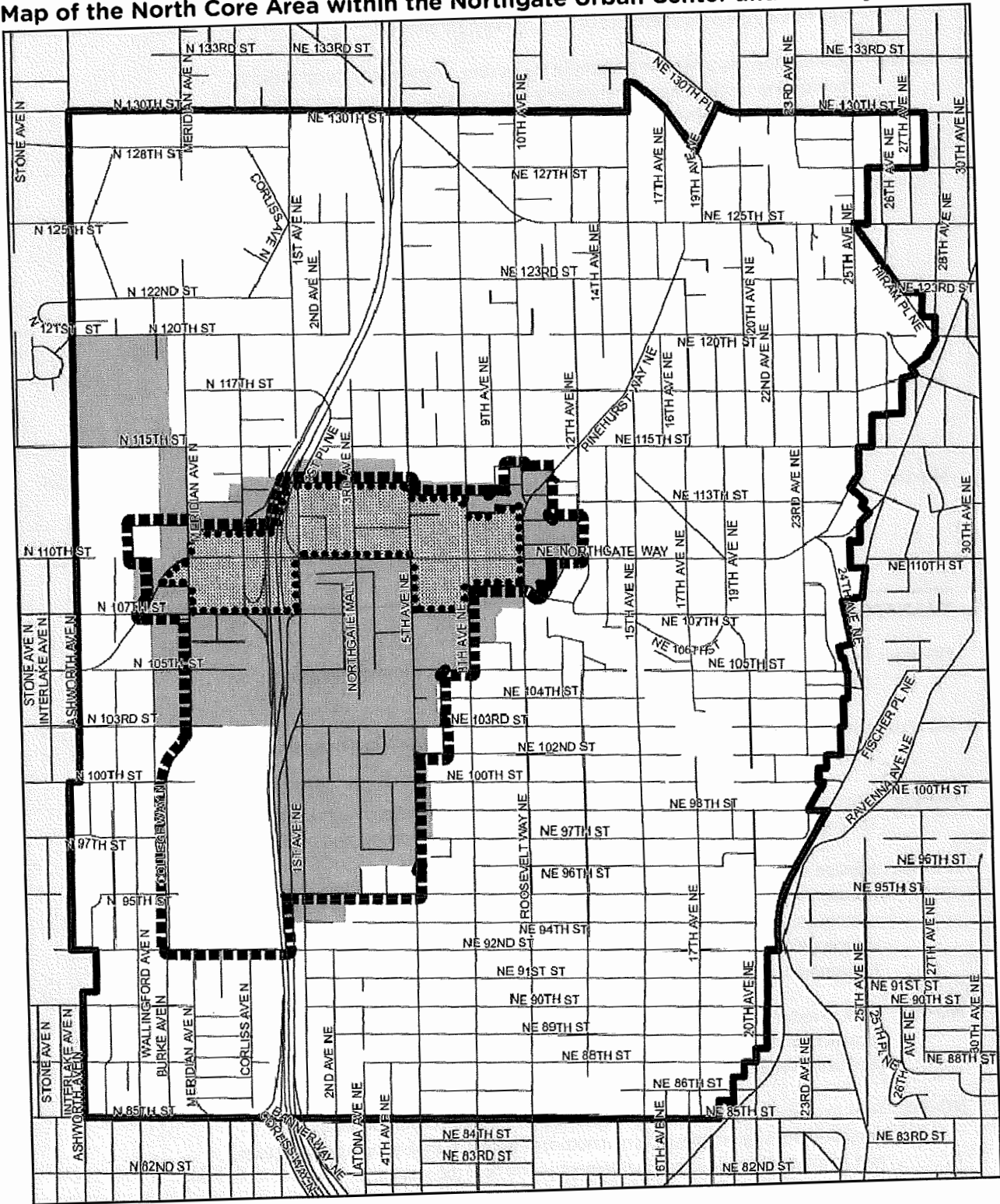

Legend

- North core subarea
- Northgate urban center
- Northgate core
- Northgate overlay district

NG-G8 Quality open space exists in sufficient quantity and variety to meet the needs of workers, shoppers, students, and visitors, as well as recreational and natural spaces for the growing residential population.

OPEN SPACE POLICY

NG-P15 Promote a system of open spaces and pedestrian connections, to guide acquisition, location, and development of future open space and to establish priorities for related public improvements.

DRAINAGE POLICY

NG-P16 Promote reduction of potential runoff into Thornton Creek, and encourage restoration of the creek to enhance aquatic habitat and absorb more runoff.

HUMAN SERVICES & COMMUNITY FACILITIES POLICY

NG-P17 Encourage quality human services for all segments of the population.

FINANCING GOAL

NG-P18 Explore and seek to develop a variety of strategies for financing implementation of these goals and policies.

Othello

LAND USE & HOUSING GOALS

- O-G1** A neighborhood that offers a broad range of activities to serve the diverse needs of the community and to encourage neighborhood sustainability, including residential, commercial, retail, service, cultural, and open space uses.
- O-G2** A neighborhood that supports the broad economic, cultural, and family-size diversity of this neighborhood by keeping housing affordable with a balance of both single-family and multifamily housing for both renters and owners.
- O-G3** The core town center, around the light rail station, is economically strong and serves the multicultural community who live, work, and shop here.
- O-G4** The Othello Residential Urban Village has parks, recreational facilities, and open spaces that are designed and programmed to accommodate users of diverse ages, interests, and cultures, and that allow for informal interactions of people from different cultures.



LAND USE & HOUSING POLICIES

- O-P1** Encourage dense urban development in the town center in a manner that creates a vibrant and active commercial district supportive of the community, along with residential infill development to increase the housing supply.
- O-P2** Maintain and augment affordable housing to keep a range of housing prices and unit sizes and a balance of rental and owner-occupied housing.
- O-P3** Encourage well-designed multifamily development to contribute to the development of a mixed-use town center development.
- O-P4** Encourage development of housing available in a range of prices and sizes, including affordable family-sized homes with amenities for families.
- O-P5** Increase opportunities for affordable homeownership by working with lenders, and nonprofit and for-profit developers.
- O-P6** Encourage the preservation of affordable housing resources through rehabilitation of existing single-family residences.
- O-P7** Encourage lenders to design mortgage programs, products, and educational materials that meet the needs of a diverse neighborhood.
- O-P8** Support low-income, senior, and disabled renters and homeowners with supportive services that will allow them to continue to live in the neighborhood.
- O-P9** In partnership with local, state, and federal agencies, ensure the preservation of a supply of subsidized housing units in the neighborhood.
- O-P10** Encourage service providers and managers to provide security and decent physical condition for transitional housing to better integrate this housing into the surrounding neighborhood.
- O-P11** Encourage a range of affordable and market-rate residential uses in mixed-use development that is within short walking distance of a light rail station.
- O-P12** Use the light rail station as a gateway with appropriate transitions to the Othello Residential Urban Village.
- O-P13** Promote development standards that accommodate a vibrant pedestrian environment throughout the town center.
- O-P14** Support a uniquely identifiable town center that is a destination for international food and cultural experiences.
- O-P15** Coordinate with other public and private agencies to plan, develop, operate, and maintain park and recreational facilities.
- O-P16** Promote public safety in parks through partnerships with local organizations and law enforcement, defensible design, lighting, and landscaping.
- O-P17** Encourage the development of pocket parks throughout the neighborhood in unopened rights-of-way and other surplus public property.



- O-P18** Use the P-Patch program as a means of increasing open space and neighborhood amenities.

ECONOMIC DEVELOPMENT GOALS



- O-G5** Ethnic diversity of Othello merchants, a key asset of this neighborhood, is supported and maintained over the years.
- O-G6** The retail and commercial core of the Othello Residential Urban Village is an attractive and vibrant area for neighborhood residents and visitors.
- O-G7** Othello has vibrant commercial areas with diverse economic opportunities for area residents, including family-wage jobs and a variety of employment.
- O-G8** A continuum of opportunities for education, training, skills enhancement, and job placement that responds to the changing needs of the work place locally and regionally, and is readily available to neighborhood residents and workers.

ECONOMIC DEVELOPMENT POLICIES

- O-P19** Support a vibrant and attractive multicultural town center in providing a range of goods for those who live, work, and shop in the neighborhood.
- O-P20** Encourage retail and services that are destination businesses for customers from the Rainier Valley and beyond, as well as those that support the culturally specific daily needs of the community.
- O-P21** Promote retail, restaurant, and entertainment uses that are pedestrian-oriented, that provide a high level of street activity, and that create a secure environment for people and businesses.
- O-P22** Strive to develop pedestrian amenities to link commercial areas, transportation facilities, residential areas, and parks.
- O-P23** Support implementation of coordinated long-term strategies for commercial district improvement including support for existing or expanding small businesses and ethnically based businesses to maintain the multicultural character.
- O-P24** Develop strategies that keep commercial space affordable for small businesses, especially culturally based businesses.
- O-P25** Support family-wage jobs in the neighborhood.
- O-P26** Support innovative employment opportunities, including green businesses and training programs.
- O-P27** Support programs that help residents be successful in their jobs, including training and apprenticeships.

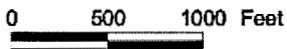
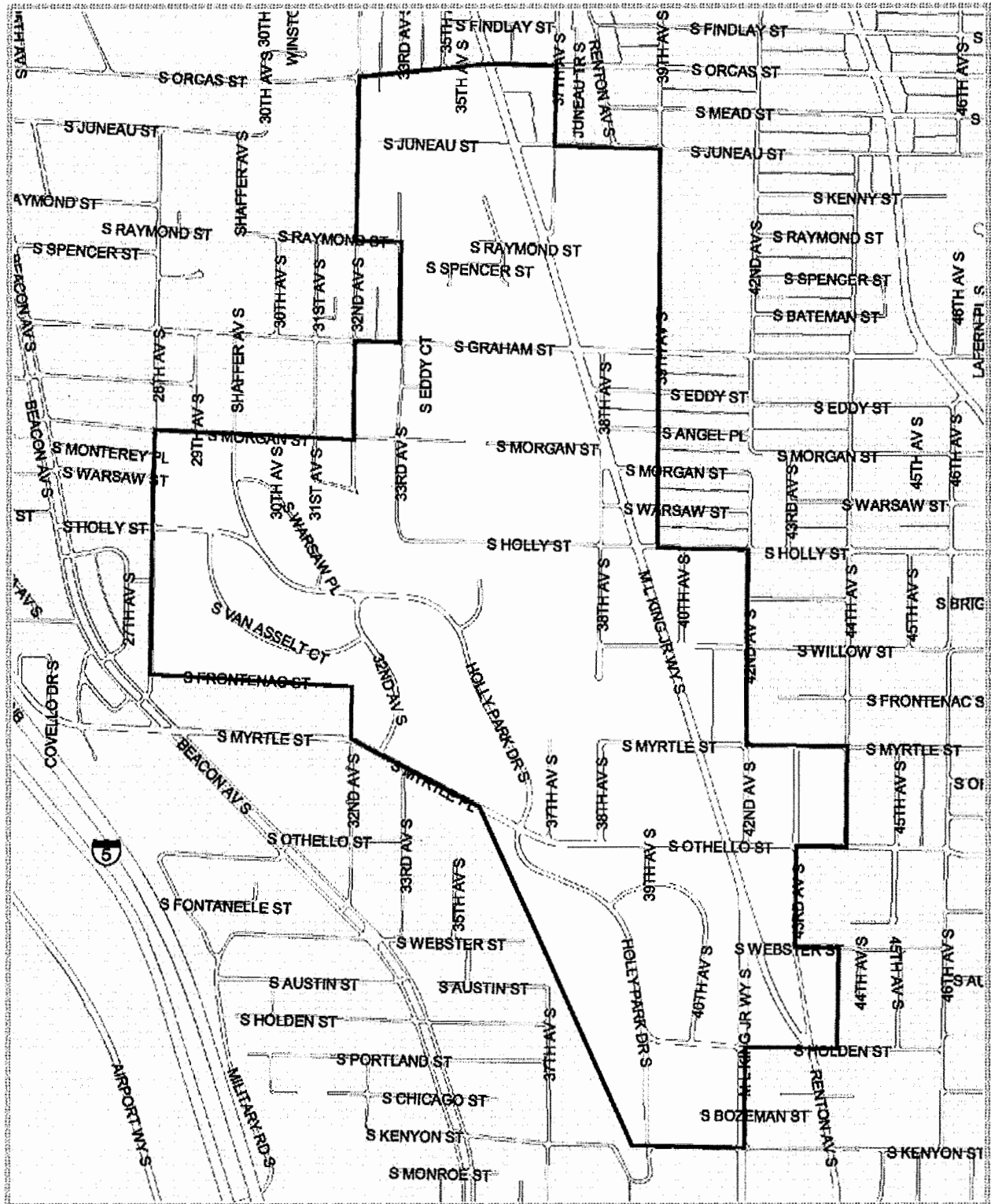
OTHELLO Residential Urban Village



 VILLAGE BOUNDARY
 EDGE OF PAVEMENT

TRANSPORTATION GOALS

- O-G9** The neighborhood has a safe and effective network of buses and trains that supports land use goals and adequately serves the community.
- O-G10** Improve circulation within the existing capacity of the arterial street system to provide cost-effective mobility and minimal neighborhood disruption.
- O-G11** There are safe and convenient pedestrian and bicycle transportation alternatives to and from residential areas, parks, schools, civic buildings, and commercial and employment areas.

TRANSPORTATION POLICIES

- O-P28** Mitigate the impact of arterial traffic on pedestrian activity and promote the safety of pedestrians by providing pedestrian amenities along arterials.
- O-P29** Create safe pedestrian and bicycle access to light rail and bus service, and to the business district, especially from the east and west.
- O-P30** Encourage King County Metro to provide effective bus service through the neighborhood to the light rail station and surrounding community facilities.
- O-P31** Work with the community to identify measures for residential streets, such as traffic circles, on-street parking, and street trees to mitigate impacts from nearby arterials.
- O-P32** Design streets for pedestrian safety, especially at light rail crossings.
- O-P33** Provide nonmotorized connections to open spaces.

PUBLIC SAFETY GOAL

- O-G12** This neighborhood is, and feels, safe for people and businesses—from crime as well as from accidents while walking, biking, and driving.

PUBLIC SAFETY POLICIES

- O-P34** Work in partnership with the community, Seattle Police Department, and other agencies to identify public safety “hot spots” and appropriate courses of remedial action such as Block Watch programs, security lighting, and the Holly Park Merchants Association Business Watch.
- O-P35** Encourage partnerships among businesses to create a safe and active commercial district.
- O-P36** Create a secure environment for people to walk and gather.
- O-P37** Create a secure environment for people and businesses.

- O-P38** Seek opportunities for the community and the Seattle Police Department to strengthen partnerships.

COMMUNITY BUILDING GOALS

- O-G13** A tightly knit community where people know how, and want, to get involved in community activities.
- O-G14** Othello offers positive and safe activities for youth, including apprentice programs, recreation opportunities, and jobs specifically for teens.
- O-G15** To support cultural diversity, there is improved access to education and employment training opportunities for all, including support specifically for immigrant and refugee families.

COMMUNITY BUILDING POLICIES

- O-P39** Encourage property and business owners to enhance and maintain the cleanliness and appearance of residential and commercial areas.
- O-P40** Support culturally inclusive local business associations that support the vitality of a business district that serves the entire community.
- O-P41** Support the growth of jobs for teenagers in the neighborhood.
- O-P42** Encourage local institutions to meet the needs of the residents through opportunities for lifelong learning in the neighborhood.
- O-P43** Improve the availability of community facilities for local organizations in the Othello Residential Urban Village.
- O-P44** Provide recreational and cultural programs and activities in parks and community centers that are relevant to the diverse population.
- O-P45** Support the creation of a variety of open spaces for informal public gathering and recreation, including an open space in the town center that can be used for community functions such as a farmers' market and cultural celebrations.
- O-P46** Enhance community pride through multicultural community festivals, youth mentoring, and other youth programs.
- O-P47** Support key cultural assets such as the Filipino Community Center, Lao Highland Community Center, and cultural media.
- O-P48** Seek opportunities and partnerships to create a shared cultural center that could accommodate offices and gathering/performance space for various multicultural and interest groups.

Pike/Pine

COMMUNITY CHARACTER GOAL

P/P-G1 A community with its own distinct identity composed of a mix of uses including multifamily residential, small-scale retail businesses, light manufacturing, auto row, and local institutions.

COMMUNITY CHARACTER POLICIES

P/P-P1 Strengthen the neighborhood's existing mixed-use character and identity by encouraging additional affordable and market-rate housing, exploring ways of supporting and promoting the independent, locally owned businesses, seeking increased opportunities for art-related facilities and activities, and encouraging a pedestrian-oriented environment.

P/P-P2 Seek to preserve the architectural and historic character of the neighborhood by exploring conservation incentives or special district designations.

ECONOMIC DEVELOPMENT GOAL

P/P-G2 A neighborhood of thriving and diverse businesses that support both lively daytime and nighttime activities. A destination for retail, arts, and entertainment.

ECONOMIC DEVELOPMENT POLICIES

P/P-P3 Encourage the development of new tools that support and promote the independent, locally owned businesses in order to improve their economic vitality and plan their development while maintaining and enhancing the unique character of the neighborhood.

P/P-P4 Strive to maintain the unique character of the neighborhood by creating programs for business retention and recruitment with a focus on supporting small, independent businesses.

P/P-P5 Collaborate with other organizations in the creation of an attractive, safe, clean, pedestrian-friendly environment in which businesses thrive.

P/P-P6 Seek to preserve and encourage the mix of light manufacturing, wholesaling, high-tech, and auto-related businesses that co-exist with smaller retailers.

P/P-P7 Support the creation of a synergistic relationship between the business community and the broader neighborhood in order to promote the shared goals of maintaining the unique character of the neighborhood while improving its livability.

HOUSING GOAL

P/P-G3 A neighborhood that welcomes increased residential densities, with additional affordable and market-rate housing, and proper infrastructure to support the densities.

HOUSING POLICIES

P/P-P8 Encourage diversity of housing while seeking to maintain existing low-income housing.

P/P-P9 Seek additional resources for the preservation of existing, affordable rental housing.

P/P-P10 Promote opportunities for owners of existing affordable rental housing to obtain financing to make property improvements without impacting rent levels.

P/P-P11 Promote the additional development of new or rehabilitated housing units, through tools such as code modifications, incentives, and providing flexibility during development review.

P/P-P12 Promote the development of mixed-use structures in general commercial areas of the Pike/Pine neighborhood, especially compatible mixed-uses such as artist live-work space.

P/P-P13 Work with nonprofit housing organizations in identifying and implementing affordable housing projects.

HUMAN NEEDS & DEVELOPMENT GOAL

P/P-G4 A neighborhood that recognizes and meets the diverse and distinctly different human service needs of a culturally and economically diverse population.

HUMAN NEEDS & DEVELOPMENT POLICIES

P/P-P14 Promote community connections and cohesion by encouraging opportunities for people to come together, interact, support, and get to know each other and participate in a range of activities.

P/P-P15 Seek to improve communication between people, organizations, and communities dealing with human needs and human development issues.

P/P-P16 Seek new tools to address human support needs in the neighborhood.

P/P-P17 Seek a comprehensive approach in addressing the human needs and problems of people within the urban center and citywide.

URBAN DESIGN GOAL

P/P-G5 A neighborhood with a distinct identity that provides a distinct and active pedestrian environment and a balance of basic amenities that serves a dense urban center village.

URBAN DESIGN POLICIES

- P/P-P18** Encourage the attraction and passage of pedestrians to and from Downtown and adjacent neighborhoods by seeking to provide improved environments along key pedestrian streets.
- P/P-P19** Seek to develop the core area east of Broadway into an active pedestrian center with connections to adjoining neighborhoods.
- P/P-P20** Strive to enhance awkward intersections where streets come together at odd angles for use as unique urban plazas and strive to improve pedestrian safety along Madison and elsewhere.
- P/P-P21** Seek to enhance sidewalks and alleys to make a better overall environment for pedestrians as well as retail activities.
- P/P-P22** Seek to enhance available open space and seek additional opportunities for pocket parks, community garden, children's play spaces, and other recreational activities.
- P/P-P23** Strengthen the recognition of the West End as the major entry point into the neighborhood.
- P/P-P24** Seek opportunities to enhance parking and traffic-calming opportunities on primarily residential cross streets, along Pike and Pine.

TRANSPORTATION GOAL

P/P-G6 A neighborhood transportation network that facilitates movement of residents, workers, students, visitors, and goods with a particular emphasis on increasing safety, supporting economic centers, and encouraging a full range of transportation choices.

TRANSPORTATION POLICIES

- P/P-P25** Encourage the use of traffic-calming measures to enhance pedestrian and bicycle travel, slow vehicular traffic, and direct through-traffic away from non-arterial streets.
- P/P-P26** Support the designation of key pedestrian linkages as green streets.
- P/P-P27** Seek to provide safer and easier crossings for pedestrians throughout the neighborhood.
- P/P-P28** Promote the improvement of primary sidewalk systems and pedestrian connections.

PIKE/PINE

Part of the Downtown Urban Center

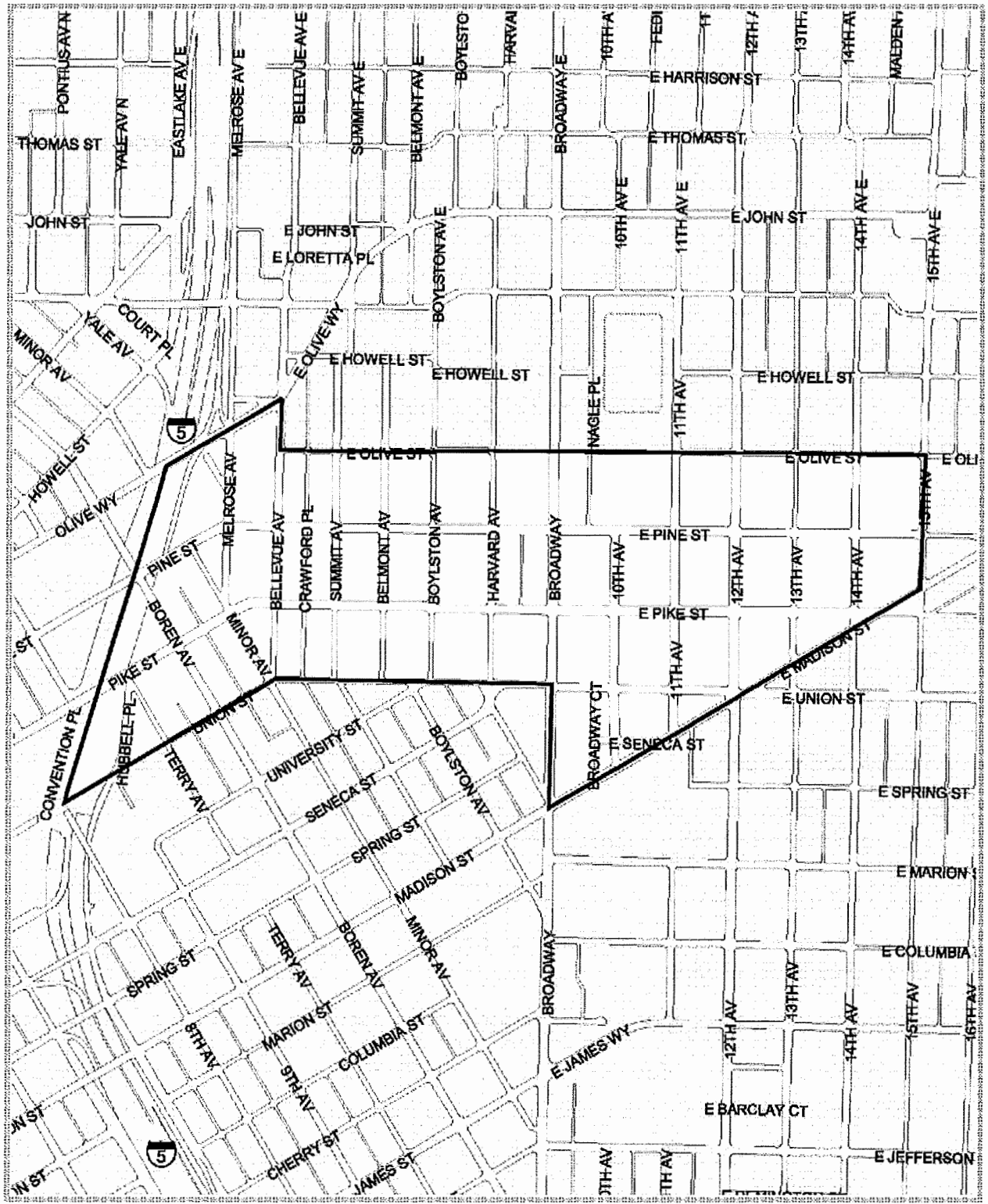

0 500 1000 Feet

VILLAGE BOUNDARY
EDGE OF PAVEMENT

P/P-P29 Encourage the completion and expansion of the urban trails system in order to provide increased bicycle access to the Pike/Pine neighborhood.

TRANSIT GOAL

P/P-P30 Seek to improve the speed, frequency, and reliability of transit serving the Pike/Pine neighborhood.

TRANSIT POLICIES

P/P-P31 Strive to make transit convenient, understandable, and easy to use.

P/P-P32 Encourage the development of additional transit options that serve the neighborhood.

P/P-P33 Encourage good access to light rail systems from the Pike/Pine neighborhood.

PARKING POLICIES

P/P-P34 Encourage parking management and transportation demand management practices as a means to reduce parking in the neighborhood.

P/P-P35 Encourage the use of residential parking zones in the neighborhood, including areas within the Neighborhood Commercial or Commercial zones and establish curb space priorities.

P/P-P36 Discourage long-term commuter parking and park-and-ride lots in the neighborhood.

P/P-P37 Promote the reduction of car ownership by residents to minimize parking demand.

FREIGHT MOBILITY POLICY

P/P-P38 Strive to provide adequate access to merchants and to major institutions for deliveries and freight movement.

ARTS & CULTURE GOALS

P/P-G7 A neighborhood that fosters the creation of arts and cultural activities and facilities in a community that brings together many diverse talents and interests.

ARTS & CULTURE POLICIES

- P/P-P39** Promote the establishment of a community-based arts organization that would function in an integrated role with other Pike/Pine organizations and those in surrounding neighborhoods.
- P/P-P40** Support and promote arts events and projects in the Pike/Pine neighborhood.

Queen Anne (Uptown)

GOALS

- QA-G1** Queen Anne is recognized for the uniqueness of its different neighborhoods, including the urban center, each with distinctive physical characteristics and a strong sense of community.
- QA-G2** Queen Anne has many single-family, multifamily, and mixed-use neighborhoods that preserve cultural and historic resources and which include affordable, subsidized, and special-needs housing.
- QA-G3** The Urban Center is a vital residential community as well as a viable and attractive commercial/employment center and mixed-use neighborhood that enjoys a strong relationship with Seattle Center.
- QA-G4** Human service needs are addressed in the Queen Anne community.
- QA-G5** Queen Anne is a neighborhood that meets the parks and open space needs of its population by maintaining existing parks, identifying future needs, providing connections between parks and the community, and enhancing historic Queen Anne Boulevard.
- QA-G6** Queen Anne retains its unique natural environment while providing a safe urban Environment.
- QA-G7** Queen Anne recognizes the impacts that traffic congestion may have on the community's quality of life and strives to address traffic and transportation issues while improving the efficiency of the local and regional transportation system.
- QA-G8** Queen Anne is a community that encourages access to a wide range of transportation modes.
- QA-G9** Queen Anne is a neighborhood with a vibrant and sustainable business community and safe commercial districts.
- QA-G10** Queen Anne's businesses are accessible and meet the needs of the community.



POLICIES

- QA-P1** Seek to create and maintain attractive pedestrian-oriented streetscapes and enhance Queen Anne's community character with open space, street trees, and other vegetation.
- QA-P2** Preserve the character of Queen Anne's single-family and mixed-use neighborhoods.
- QA-P3** Seek to maintain and establish quality design in the Queen Anne area. Through neighborhood design guidelines and design review, consider unique or particular local design characteristics, and include consideration of signage, adjacent public right-of-ways, and historic boulevards.
- QA-P4** Recognize and promote Queen Anne's historic resources through such means as developing a Roy Street Conservation District, preserving and enhancing the historic Queen Anne Boulevard, and providing information about and incentives to preserve residential structures.
- QA-P5** Encourage an attractive range of housing types and housing strategies to retain Queen Anne's eclectic residential character and to assure that housing is available to a diverse population.
- QA-P6** Create a unique urban identity in Queen Anne's Urban Center that includes an attractive multifamily residential neighborhood identified by its distinctive park-like character and surrounding mixed-use areas.
- QA-P7** Seek to establish high-capacity transit/multimodal node(s) in the urban center that will be centrally located and convenient to residents, businesses, and Seattle Center.
- QA-P8** Promote affordable locations for business in the urban center.
- QA-P9** Enhance the unique character of each business district.
- QA-P10** The special L3 and L4 locational criteria for the evaluation of rezones to the L3 and L4 designations inside of urban villages shall not apply in the Upper Queen Anne Residential Urban Village.
- QA-P11** Provide for an attractive and harmonious transition between different land uses, including commercial areas and single-family areas.
- QA-P12** Legal non-conforming uses exist in Queen Anne's single-family neighborhoods, and these shall be allowed to remain at their current intensity, as provided in the Land Use Code, to provide a compatible mix and balance of use types and housing densities.
- QA-P13** Accessory dwelling units (ADUs) in single-family zones, in the Queen Anne planning area, should continue to be limited to the principal residential structure, and consider requiring that they be subordinate in size and character in order to discourage the development of duplexes and other multifamily structures in these zones.
- QA-P14** Encourage Seattle Center to plan and implement development that will enhance the quality of life in the Queen Anne neighborhood.

- QA-P15** Seek ways to ensure that Seattle Center remains a vibrant and valuable community resource and a premier regional amenity.
- QA-P16** Encourage the development of a unique urban residential neighborhood in the urban center through such means as allowing Single-Purpose Residential buildings in designated portions of Neighborhood Commercial 3 (NC3) zones.
- QA-P17** Strive to develop a Queen Anne neighborhood facility in the urban center that will serve the needs of the community as a community and resource center.
- QA-P18** Promote methods of assuring that existing housing stock will enable changing households to remain in the same home or neighborhood for many years.
- QA-P19** Seek to maintain Queen Anne parks and open spaces and replace aging parks facilities used by the public, and seek to ensure no net loss of parks, park facilities, or open spaces while recognizing the need for a citywide balance in ongoing maintenance and investment.
- QA-P20** Accommodate a range of uses in parks to meet the needs and interests of the Queen Anne population.
- QA-P21** Strive to meet the open space and parks and recreation needs of the Queen Anne population, including the Urban Center.
- QA-P22** Strive to provide trails and nonmotorized linkages throughout and around Queen Anne.
- QA-P23** Seek to provide abundant green spaces and streetscapes throughout Queen Anne.
- QA-P24** Preserve and encourage the enhancement and development of historic Queen Anne Boulevard as a major park/recreation/pedestrian trail element.
- QA-P25** Seek to retain and enhance the habitat value of Queen Anne's open spaces and undeveloped public lands.
- QA-P26** Protect the ecological integrity of critical areas.
- QA-P27** Ensure appropriate drainage in Queen Anne's open spaces and critical areas.
- QA-P28** Ensure that public park lands are retained and maintained for public use.
- QA-P29** Strive to diversify transportation modes and emphasize non-SOV travel within the Queen Anne neighborhood.
- QA-P30** Seek to find solutions to Queen Anne's traffic congestion.
- QA-P31** Promote a human scale and character within the heart of the urban center and strive to reduce industrial through-traffic.
- QA-P32** Promote enhanced mobility and mobility options between Queen Anne and other neighborhoods, employment centers, and recreation centers.
- QA-P33** Transportation facilities and services should be consistent with and enhance Queen Anne's unique urban character.



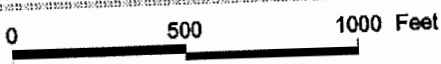
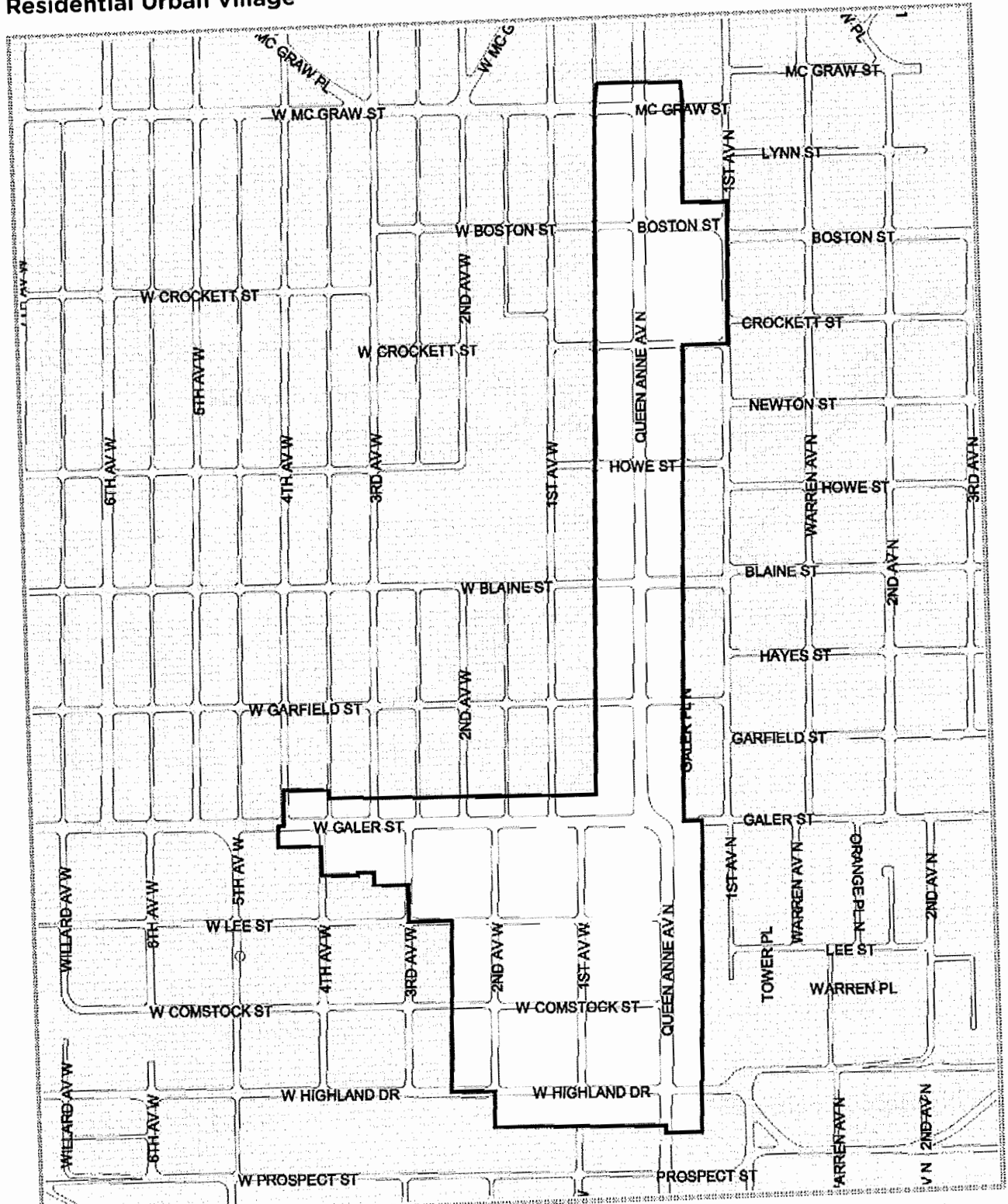

UPPER QUEEN ANNE Residential Urban Village

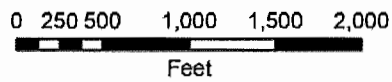
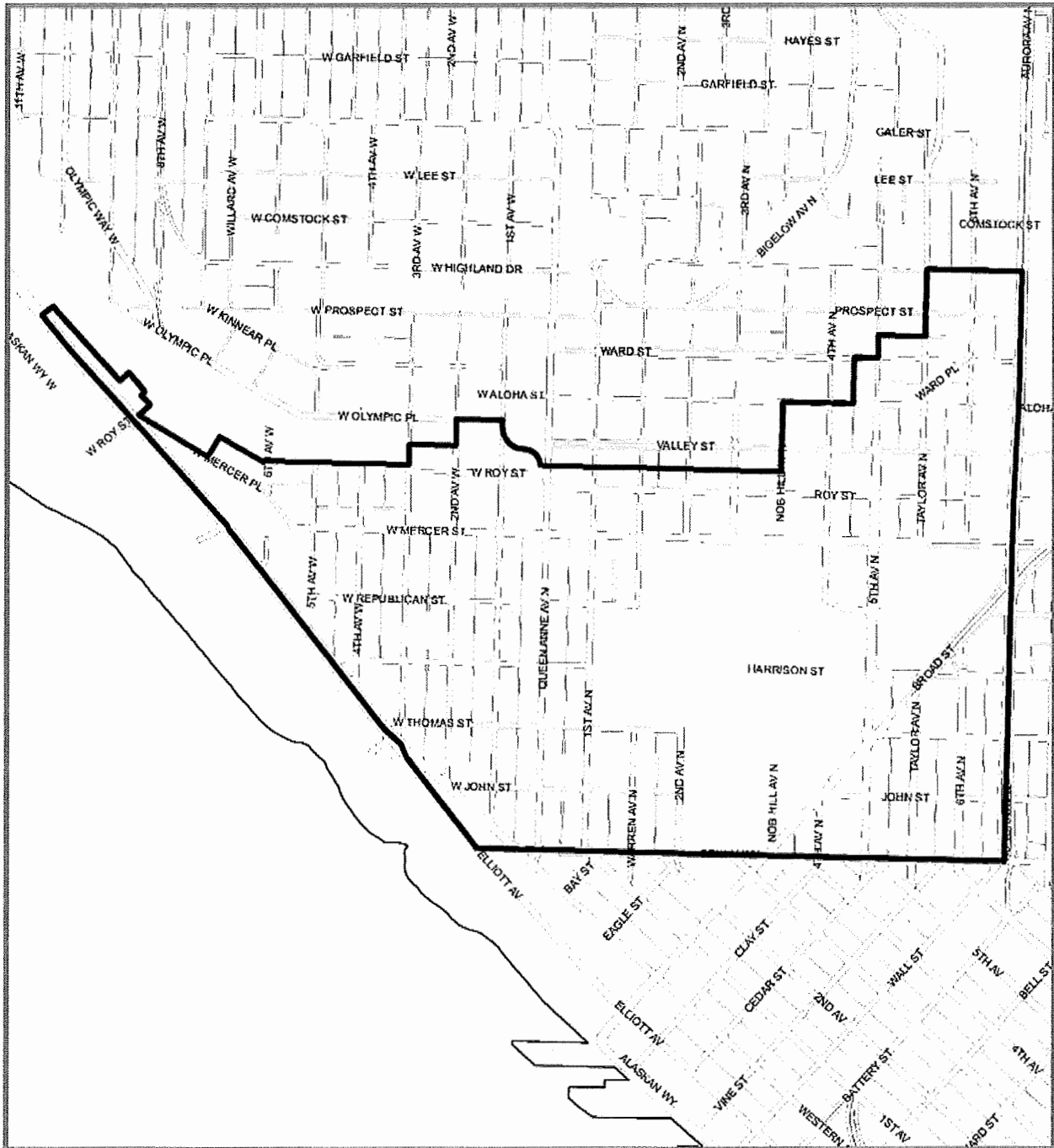

VILLAGE BOUNDARY
EDGE OF PAVEMENT

**UPTOWN
Urban Center**



 Village Boundary
 Edge of Pavement

- QA-P34** Strive to provide multimodal linkages and access to and within Queen Anne and adjacent employment centers.
- QA-P35** Strive to provide high-capacity transit services, including light rail, to the urban center.
- QA-P36** Strive to provide convenient and efficient transit linkages throughout Queen Anne with an emphasis on linking Upper Queen Anne and the urban center.
- QA-P37** Strive to provide improved facilities for transit.
- QA-P38** Strive to provide a system of bicycle facilities and routes within and around Queen Anne to encourage increasingly safe and convenient commuter and recreational bicycle use as an alternative to motorized travel.
- QA-P39** Strive to provide convenient and safe bicycle and pedestrian access between Queen Anne and the Elliott Bay waterfront.
- QA-P40** Strive to provide urban character-enhancing improvements to Queen Anne's streets such as sidewalk improvements, transit facilities, landscaping, and appropriate lighting.
- QA-P41** Seek to alleviate parking problems in the Queen Anne planning area.
- QA-P42** Strive to ensure adequate facilities, such as lighting, for safety in pedestrian and parking areas in Queen Anne's business districts.
- QA-P43** Strive to ensure that Queen Anne's commercial areas and business districts are safe from crime.
- QA-P44** Strive to find solutions to the parking needs of Queen Anne's business districts.
- QA-P45** Seek to fill identified market gaps in Queen Anne and support locally owned businesses and other businesses that meet the needs of the local population.

Rainier Beach

LAND USE GOALS

- RB-G1** A diverse and vibrant neighborhood composed of pedestrian-friendly, transit-connected business districts, and affordable and attractive residential areas.
- RB-G2** For Rainier Beach, the town center is an interconnected and vibrant set of places where the community comes together. These places reflect the diverse cultures, histories, and traditions that collectively give Rainier Beach its identity.

LAND USE POLICIES

- RB-P1** Encourage the revitalization of the South Henderson Street corridor as a safe and attractive conduit between the light rail station at Martin Luther King Jr. Way South and the commercial center along Rainier Avenue South.
- RB-P2** Seek to promote transit-oriented development around Rainier Beach's light rail station at Martin Luther King Jr. Way South and South Henderson Street.
- RB-P3** Encourage mixed-use housing and commercial development in the Beach Square area bounded by South Henderson Street to the north, Rainier Avenue South to the south and west, and Seward Park Avenue South to the east.
- RB-P4** Seek to preserve the character of Rainier Beach's single-family zoned areas. Encourage residential small-lot opportunities within single-family areas within the designated residential urban village. In the area within the residential urban village west of Martin Luther King Way South, permit consideration of rezones of single-family zoned land to mixed-use designations.
- RB-P5** Encourage the City to support rezones within the Rainier Beach Residential Urban Village for projects that:
- A. meet the overall community vision,
 - B. promote redevelopment of underutilized and derelict sites, and
 - C. result in pedestrian-friendly, well-designed new buildings.

TRANSPORTATION & TRANSIT FACILITIES GOALS

- RB-G3** A community with safe streets, pedestrian- and bicycle-friendly facilities, and an efficient, multimodal transit system that supports access to shops, schools, services, places of worship, etc. that are necessary to lead a healthy lifestyle, and connects Rainier Beach residents and employees to other parts of the Rainier Valley and the region. A safe walking environment should be free from crime, and protected from motorists. It should also include amenities such as landscaping, street trees, and public art that contribute to an enjoyable environment.
- RB-G4** Integrated transportation improvements that serve the community.

TRANSPORTATION & TRANSIT FACILITIES POLICIES

- RB-P6** Improve residential streets to best serve residential neighborhoods.
- RB-P7** Seek to promote nonmotorized travel throughout Rainier Beach by providing facilities for pedestrians and bicyclists (as outlined in the Southeast Transportation Study, and Pedestrian and Bicycle Master Plans), particularly at the business nodes along the S. Henderson Street corridor, near the light rail station, and around the Beach Square commercial core.



- RB-P8** Explore a range of alternative transportation modes and solutions that would support the concepts of sustainability and environmental responsibility.
- RB-P9** Seek to strengthen provisions for code enforcement of transportation-related violations such as speeding, and parking violations.
- RB-P10** Coordinate transportation improvements with other infrastructure and programmatic actions (such as public art, parks, or economic development) so that those improvements contribute positively to the neighborhood's identity.

HOUSING GOAL

- RB-G5** A community that meets the housing needs of its economically diverse and multicultural population and provides opportunities at all economic levels.
- RB-G6** Retain and develop affordable (low and moderate income) housing, especially where such housing is accessible to transit.

HOUSING POLICIES

- RB-P11** Encourage attractive multifamily development, affordable to the neighborhood's economically diverse population, particularly along Rainier Avenue South from South Holly Street to South Cloverdale Street, and as part of South Henderson Street revitalization efforts.
- RB-P12** Seek to preserve the economic, racial/ethnic, and cultural diversity of Rainier Beach's population by providing affordable housing, including homeownership opportunities, through capital funding and incentive programs (e.g., Multifamily Tax Exemption) and land use/zoning tools, including, where appropriate, rezones.
- RB-P13** Seek to promote townhomes and mixed-use buildings as the preferred development pattern for meeting the housing growth target for the Rainier Beach Residential Urban Village.
- RB-P14** Address the causes of the perception of crime, the lack of personal safety, and the detraction from Rainier Beach's community character such as by cleaning up derelict residential properties.
- RB-P15** Increase opportunities for home-occupation, and live-work development that allows ground floor business including small-scale retail and services in the station area and along South Henderson Street.
- RB-P16** Encourage affordable family-sized units through incentives, direct City funding, and reuse of publicly owned property.

CAPITAL FACILITIES GOALS

- RB-G7** A community with a variety of parks and open spaces, civic facilities, waterfront access, and a trail system that promotes the existing open space sites, and the enjoyment of new public spaces.
- RB-G8** Connected parks and open space that serve the community.
- RB-G9** Use the arts and public art, in particular, to engage and express Rainier Beach's cultural diversity.

CAPITAL FACILITIES POLICIES

- RB-P17** Support the Rainier Beach Urban Farm and Wetlands Project to convert the Parks Department's Atlantic Street Nursery into an urban farm and wetlands restoration project.
- RB-P18** Seek to retain existing parks and recreation facilities, and strive to improve maintenance of these facilities.
- RB-P19** Recognize the importance of actively programming, strengthening connections to the community, and maintaining the Rainier Beach Community Center and South Shore Middle School to help foster a civic core.
- RB-P20** Seek to promote the development of pedestrian trails that connect residential areas to the commercial core, and bring pedestrians from the Rainier View neighborhood down to the lower Rainier Beach valley.
- RB-P21** Improve connections to, and circulation within, public spaces (South Shore K-8, Rainier Beach Playfield, Rainier Beach High School, and between Beer Sheva and Pritchard Beach).
- RB-P22** Seek to include art created by local artists, and which includes the input of ethnic and minority communities in exploring themes and locations, in public works construction projects in Rainier Beach.
- RB-P23** Seek to ensure coordination between City departments, private service providers, and volunteers for the maintenance, cleaning, and general landscape upkeep of Rainier Beach's public streets and civic areas.

ECONOMIC DEVELOPMENT GOAL

- RB-G10** A revitalized commercial business core that attracts the patronage of local and citywide residents and employees through an attractive, safe, and clean built environment.
- RB-G11** A strong local economy for Rainier Beach.
- RB-G12** Strong entrepreneurship that creates jobs and grows the local economy.



RAINIER BEACH Residential Urban Village

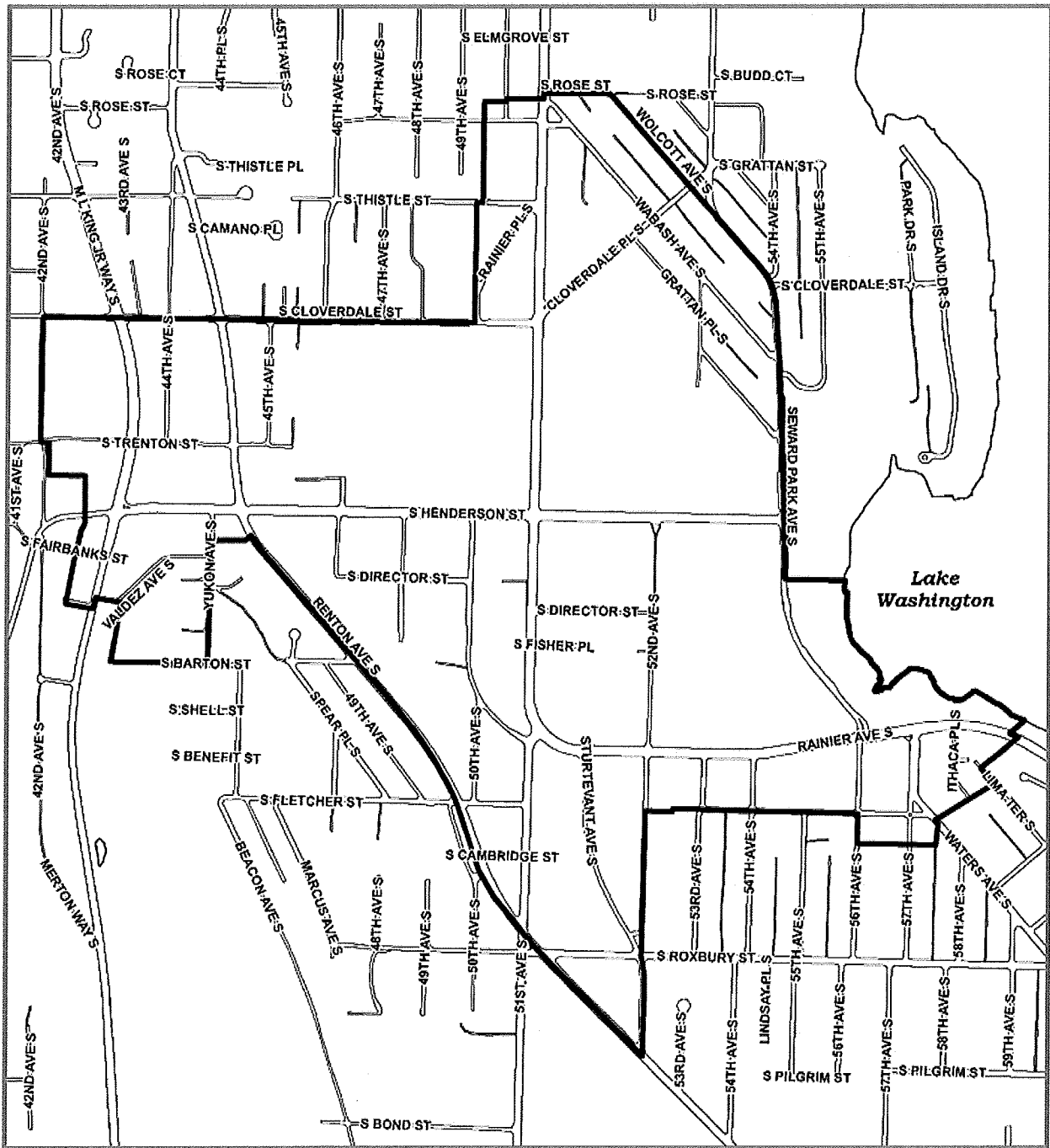

Village Boundary
 Edge of Pavement

ECONOMIC DEVELOPMENT POLICIES

- RB-P24** Seek to promote Beach Square as Rainier Beach’s hub of commercial retail activity.
- RB-P25** Support and expand the existing character and diverse mix of small-scale, minority, and immigrant-owned businesses nodes around Rainier Ave South and South Rose Street; Rainier Avenue South and 56th/57th Avenue South; and the rail station.
- RB-26** Encourage partnerships among local housing providers, community development corporations, neighborhood and business organizations, and the City to assist with economic revitalization in Rainier Beach.
- RB-P27** As part of community development, seek to provide programs that equip individuals and families with the tools for achieving sustainable wealth creation; managing their money; making sound financial decisions; and building wealth.
- RB-P28** Consider strategies for employing youth when funding and implementing economic development programs.
- RB-P29** Encourage Sound Transit to develop its properties south of the rail station in ways that create permanent, well-paying jobs.
- RB-P30** Build on the asset of community diversity and consider the specific needs of minority and immigrant-owned businesses when undertaking economic development.
- RB-P31** Use streetscape improvements to enhance the character of the town center and support small, locally owned businesses located there.

HUMAN DEVELOPMENT GOAL

- RB-G13** Strong schools with excellent programs and strong enrollment, which encourage and support the educational development of exceptional students.
- RB-G14** Education is integrated as an innovative and connected learning system into all levels of community life for all residents, resulting in the empowerment of the community and the promotion of lifelong learning.
- RB-G15** Strong institutions and activities that engage and support Rainier Beach youth.
- RB-G16** Ready access to healthy food.
- RB-G17** Community-based implementation of neighborhood plan recommendations and other community projects.
- RB-G18** Neighborhood spaces that support Rainier Beach’s many cultures.
- RB-G19** Arts and public art, in particular, are used to engage and express Rainier Beach’s cultural diversity.
- RB-G20** A positive identity for Rainier Beach based on its unique strengths.
- RB-G21** A safe Rainier Beach neighborhood.



HUMAN DEVELOPMENT POLICIES

- RB-P32** Create strong partnerships between Seattle school district and the City of Seattle to support capital and programmatic improvements for schools in the Rainier Beach area.
- RB-P33** Integrate the concept of lifelong learning including education and job-related activities into the programs provided by the schools and by the neighborhood's entire educational system.
- RB-P34** Seek to attract a community college facility that serves the Rainier Beach community in order to offer local college-level studies and to establish connections to four-year colleges.
- RB-P35** Encourage parents and adults in the community to work with school administrators to improve schools in the Rainier Beach area.
- RB-P36** Seek to facilitate and improve the participation of parents and adults in the neighborhood schools by encouraging formation of active PTAs and by outreach to the non- and limited English-speaking population of Rainier Beach.
- RB-P37** Encourage a community grass-roots approach to involve religious organizations and other influential organizations in community education issues.
- RB-P38** Work with existing community organizations and/or create new community organizations to implement plan update recommendations.
- RB-P39** Use public relations strategies to highlight Rainier Beach's community identity as a thriving and interconnected community with diverse households and supported by strong social and cultural institutions and services.
- RB-P40** Improve public safety when implementing any project or program within the community.
- RB-P41** Build and sustain a positive relationship between Seattle Police and the diverse cultures in Rainier Beach.

Roosevelt

LAND USE GOALS

- R-LUG1** Foster development in a way that preserves single-family residentially zoned enclaves and provides appropriate transitions to more dense, or incompatible, uses.
- R-LUG2** Promote the growth of the Roosevelt Urban Village in a manner that concentrates residential and business uses in the commercial core and near the light rail station, with less dense residential, mixed-use, and commercial development along the commercial arterials that extend from the core.



R-LUG3 Promote the design of private development and public facilities that protects and enhances public views and vistas.

LAND USE POLICIES

R-LUP1 Support a zoning strategy that consolidates similar zoning into whole blocks in and near the urban core and light rail station, to result in more compatible development.

R-LUP2 Support the infill development of commercial-zoned properties that are vacant or underutilized.

R-LUP3 Promote the development of new multifamily dwellings, in properly zoned areas, that will buffer single-family areas from the commercial core, freeway, and commercial corridors.

TRANSPORTATION GOALS

R-TG1 Accommodate anticipated increases in transit, truck, and automobile traffic on arterials.

R-TG2 Balance the use of arterials for the movement of people and goods with parking needs.

R-TG3 Minimize cut-through traffic on non-arterial streets.

R-TG4 Respect the Olmsted legacy of Ravenna Boulevard as an element of the city's transportation and open space systems.

R-TG5 Ensure that Roosevelt continues to be well integrated into the regional transportation infrastructure.

TRANSPORTATION POLICIES

R-TP1 Acknowledge that the existing built street environment must accommodate foreseeable traffic increases and provide interface with the light rail station.

R-TP2 Promote sidewalk design on principal and minor arterials to encourage pedestrian use and improve pedestrian safety.

PARKING GOALS

R-TG6 Promote the preservation of on-street parking for residents and their guests on minor arterials without bus routes and local access streets.

R-TG7 Promote the efficient use of on-street parking on principal and minor arterials.

- R-HG3** Accommodate most of the expected residential growth by encouraging larger development in and around the Roosevelt Urban Village's light rail station and commercial core.

HOUSING POLICIES

- R-HP1** Promote the preservation and maintenance of existing single-family homes in single-family zones and control impacts to homes on the edge of the single-family zones.
- R-HP2** Encourage an appropriate fit of scale and architectural character in all new developments.
- R-HP3** Encourage extended families and families with children to reside in Roosevelt.
- R-HP4** Encourage housing options for people with disabilities, senior citizens, and those with low or moderate-income levels.
- R-HP5** Create housing opportunities that allow Roosevelt residents to stay in the neighborhood through various life stages.
- R-HP6** Encourage mixed-use and larger multifamily structures in and immediately surrounding the transit and commercial core to accommodate increased density in our neighborhood.

CAPITOL FACILITIES GOALS

- R-CFG1** As growth in the neighborhood occurs and density increases, provide public open spaces and indoor and outdoor community gathering places for neighborhood enjoyment.
- R-CFP2** Provide safe, well-maintained parks and open spaces with a variety of facilities that will promote positive activity.

CAPITAL FACILITIES POLICIES

- R-CFP1** Protect the value of Roosevelt's public spaces by controlling shadow impacts from surrounding development, enhancing and maintaining the landscape and facilities, and preserving public views from these spaces of the Olympic Mountains and Mount Rainier, the Downtown Seattle skyline, and other City landmarks.
- R-CFP2** Promote increased use of existing public open spaces.
- R-CFG3** Provide open space to support higher-density residential development in appropriately zoned areas, including public plazas and other urban amenities in the commercial core and at the light rail station.



- R-CFP4** Consider redevelopment of underused or decommissioned properties or facilities as a way to increase the amount of parks and recreation facilities and open space in the neighborhood.
- R-CFP5** Promote the design and programming of existing open spaces and facilities for alternative activities and shared uses.
- R-CFP6** Provide trails and corridors that connect existing and new parks and open spaces, to create an open space network.

UTILITIES GOALS

- R-UG1** Maintain and enhance access for Roosevelt residents and businesses to the broadest range of utility systems available within Seattle.
- R-UG2** Help achieve overall City goals to reduce the use of energy and the production of nonrecyclable waste and to increase the reuse of stormwater and the recycling of solid waste.
- R-UG3** Reduce the visual impact of utilities in the Roosevelt neighborhood.

UTILITIES POLICIES

- R-UP1** Promote Roosevelt as a neighborhood of high technology connectivity.
- R-UP2** Strive to ensure that all residents and businesses have equal access to public and private utilities and programs that reduce cost and waste.
- R-UP3** Encourage the participation by all Roosevelt residents and businesses in voluntary programs for yard waste reduction and recycling, rainwater collection and reuse, solar connection to the City's electrical grid, and other such programs as may be sponsored by the City, private utilities, or other public organizations.
- R-UP4** Promote the use of sustainable building products and energy/water-conserving fixtures in all new construction.
- R-UP5** Encourage the screening of above-ground utility facilities, such as electrical substations, with either landscaping or artistic treatments.

ECONOMIC DEVELOPMENT GOALS

- R-EDG1** Promote the health of the Roosevelt neighborhood commercial core and foster a strong, vibrant, pedestrian-oriented neighborhood business district.
- R-EDG2** Take advantage of the location of the light rail station by promoting mixed-use development that includes both businesses and multifamily housing near the station to serve the diverse population of the Roosevelt neighborhood.



R-EDG4 Recognize that Roosevelt's cultural resources, including schools, institutions, traditions, historic resources, and creative people, are important contributors to our neighborhood economy, as well as to the city.

ECONOMIC DEVELOPMENT POLICIES

R-EDP1 Support retention and growth of existing businesses, industries, and small firms within the Roosevelt Urban Village, and actively seek to attract new businesses appropriate to the neighborhood context and infrastructure.

R-EDP2 Promote opportunities for business development related to users of the Roosevelt light rail station.

R-EDP3 Encourage development of live-work arrangements within traditional commercial and office spaces, as a way to encourage small business owners to live in the neighborhood.

R-EDP4 Strengthen ties with schools, institutions, arts and cultural entities, nonprofits, and other organizations and recognize their contributions of economic diversity, living wage jobs, and economic activity to the neighborhood.

HUMAN DEVELOPMENT GOALS

R-HDG1 Make Roosevelt a neighborhood that supports a variety of lifestyles and families of all sizes, where all can be involved in community and neighborhood life.

R-HDG2 Create an environment for sustainable living, accessible health care, education, and housing within the Roosevelt community.

HUMAN DEVELOPMENT POLICIES

R-HDP1 Create opportunities that build connections through community service and volunteering.

R-HDP2 Promote respect and appreciation for diversity in the Roosevelt neighborhood and compassion for those in the neighborhood who are disadvantaged.

R-HDP3 Promote public safety through active community involvement and good urban design.

R-HDP4 Foster a family-friendly environment and activities that promote cross-generational participation and that increase youths' attachment to the community.

R-HDP5 Support programs that provide assistance to disadvantaged individuals and families.



ENVIRONMENT GOALS

- R-EG1** Maintain a healthy natural environment as the Roosevelt neighborhood accommodates growth.
- R-EG2** Maintain and enhance the legacy of environmental stewardship in the Roosevelt neighborhood.

ENVIRONMENT POLICIES

- R-EP1** Protect and enhance the urban forest on public and private property to reduce storm runoff, absorb air pollutants, reduce noise, stabilize soil, and provide habitat.
- R-EP2** Discourage the use of chemical products on lawns and gardens and for household use and discourage impervious ground surfaces to help protect the quality of Seattle's water bodies.
- R-EP2** Maintain and enhance environmental quality through the use of natural systems to reduce pollution and greenhouse gases in the air and to clean and control stormwater runoff.
- R-EP3** Promote conservation of resources and energy, and use of sustainable building products, through education, design review, and community action.
- R-EP4** Strive to protect and retain exceptional trees and groups of trees that enhance Roosevelt's historical, cultural, environmental, and aesthetic character.
- R-EP5** Promote the use of environmentally friendly modes of transportation and other ways of reducing greenhouse gases, such as alternative heating systems and reduced use of gasoline-powered devices.
- R-EP6** Promote site planning and building design that reduce energy use through natural lighting, natural ventilation, and solar orientation.
- R-EP7** Promote street and other outdoor lighting fixtures that reduce light pollution, such as through the use of hoods and downward orientation.

South Lake Union

NEIGHBORHOOD CHARACTER GOALS

- SLU-G1** A vital and eclectic neighborhood where people both live and work, where use of transit, walking, and bicycling is encouraged, and where there are a range of housing choices, diverse businesses, arts, a lively and inviting street life, and amenities to support and attract residents, employees, and visitors.



- SLU-G2** A neighborhood that recognizes its history as a maritime and industrial community and embraces its future as a growing urban center that provides for a wide range of uses.
- SLU-G3** A neighborhood that serves as a regional center for innovative organizations and that supports a diverse and vibrant job base.
- SLU-G4** A neighborhood where arts and culture thrive, with attractions for citywide audiences and a broad range of arts and cultural organizations.
- SLU-G5** A neighborhood that supports this and future generations by providing community-based historical, cultural, artistic, and scientific learning and enrichment activities for children, residents, employees, and visitors.

NEIGHBORHOOD CHARACTER POLICIES

- SLU-P1** Encourage the colocation of retail, community, arts, and other pedestrian-oriented activities in key pedestrian nodes and corridors.
- SLU-P2** Promote diversity of building styles and support the diverse characters of neighborhood subareas.
- SLU-P3** Encourage public and private developers to consider existing neighborhood character when designing projects adjacent to parks and historical sites.
- SLU-P4** Work with the community to develop strategies to make the neighborhood safe for all community members.
- SLU-P5** Encourage designs of public spaces and private buildings that can accommodate the needs of people across a range of ages and abilities, allowing residents to age in place.
- SLU-P6** Establish incentives to encourage preservation, reuse, and rehabilitation of historically significant structures in the neighborhood; explore incentives to encourage the adaptive reuse of other older buildings in the neighborhood that provide a visual reminder of the past; and promote diversity of character and building types.
- SLU-P7** Support existing organizations that provide for an eclectic and livable community, including arts and culture, human services, maritime, and educational organizations.
- SLU-P8** Seek to maintain a diversity of uses in the neighborhood, including maritime, industrial, and Downtown-core service businesses traditionally occupying the neighborhood.
- SLU-P9** Support the growth of innovative industries in South Lake Union including biotechnology, information technology, environmental sciences, and technology, and sustainable building.
- SLU-P10** Foster a collaborative and creative community through interaction among community members and different types of organizations in the community,



including those engaged in arts and culture, human services, and education, as well as neighborhood businesses and organizations.

- SLU-P11** Encourage characteristics that favor a sustainable arts and cultural presence, including affordable and adaptable venues for making, performing, and displaying art that meet the diverse needs of artists and arts organizations.
- SLU-P12** Provide for a livable community by encouraging artistic activities that create a positive street presence.
- SLU-P13** Seek to incorporate the arts into the design of public projects and the use of public spaces.
- SLU-P14** In order to support neighborhood families, encourage existing and new schools and childcare facilities in South Lake Union and adjacent neighborhoods.
- SLU-P15** Recognize the heritage of the neighborhood and the rich diversity of neighborhood businesses and organizations as opportunities for learning.
- SLU-P16** Encourage the development of higher education, apprenticeship and internship opportunities, and adult learning offerings that build on the innovative climate of the community.

TRANSPORTATION GOALS

- SLU-G6** A livable, walkable community that is well served by transit and easy to get around by foot, bike, or transit.
- SLU-G7** A transportation system that provides safe, convenient access to businesses, residences, and other activities in the neighborhood.
- SLU-G8** A well-connected neighborhood with bicycle, pedestrian, waterborne, and vehicular access to adjacent neighborhoods.
- SLU-G9** A neighborhood with principal arterials that move people and freight efficiently through the neighborhood, support local access, and provide circulation for all modes.

TRANSPORTATION POLICIES

- SLU-P17** Work with transit agencies to provide transit service to and through South Lake Union to meet growing demand and changing markets.
- SLU-P18** Promote a system of safe pedestrian and bicycle connections linking key activity areas and destinations, such as open spaces, schools, and arts facilities.
- SLU-P19** Collaborate with businesses, developers, housing providers, and transit providers to reduce demand for automobile trips by making transit and other alternative modes attractive choices for residents and commuters.



SOUTH LAKE UNION Hub Urban Village

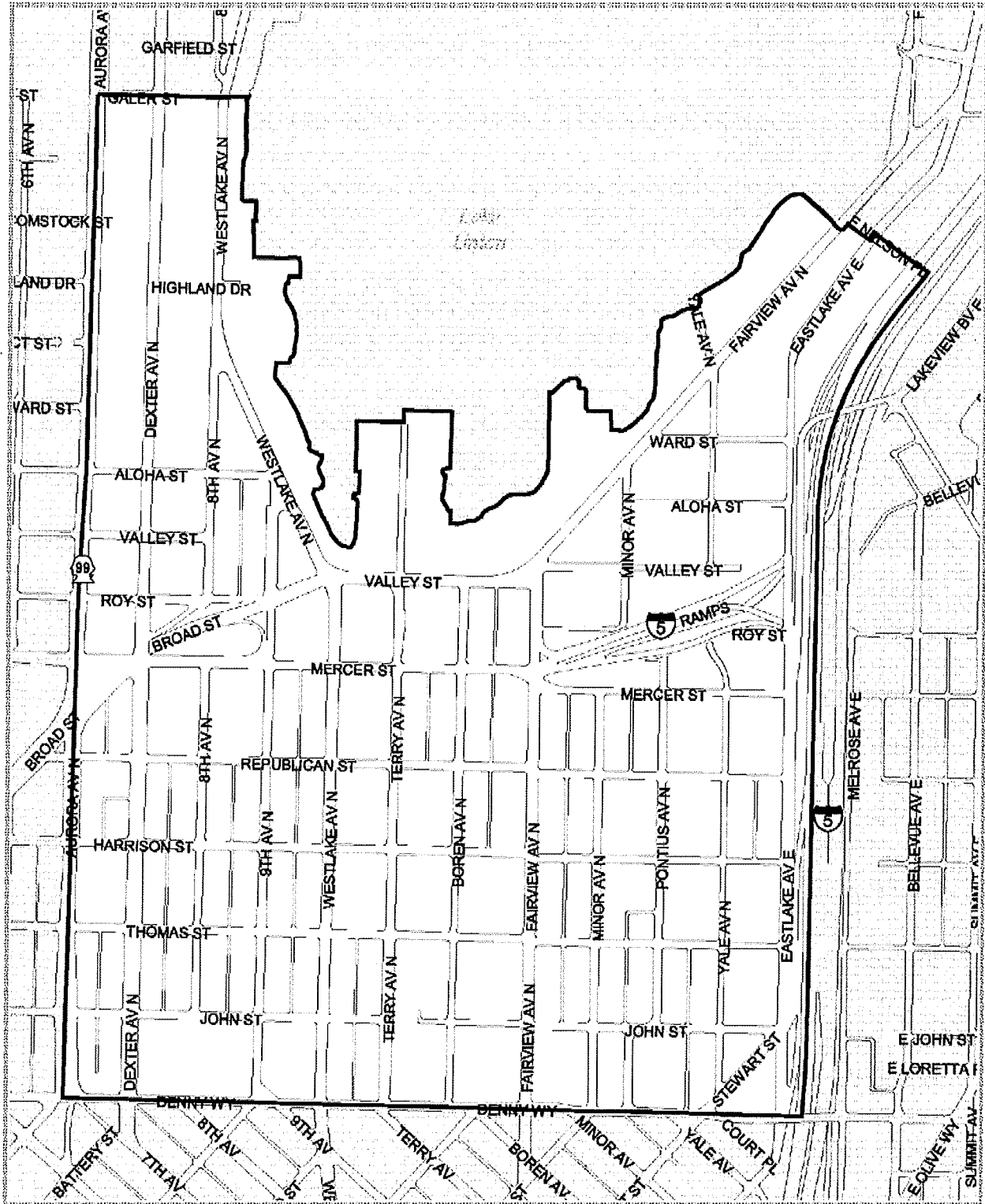

VILLAGE BOUNDARY
 EDGE OF PAVEMENT

- SLU-P20** Develop flexible off-street parking requirements that provide parking adequate to a building's occupants and encourage the use of transit, walking, bicycling, and other non-automotive modes.
- SLU-P21** Encourage the efficient use of on-street parking for neighborhood businesses, residents, and attractions through innovative parking management and pricing strategies.
- SLU-P22** Explore transportation improvements to link South Lake Union with its surrounding neighborhoods.
- SLU-P23** Seek to provide improved access to and connections across Aurora Avenue North that result in a more integrated and efficient transportation system for multiple transportation modes.
- SLU-P24** Create a street network that enhances local circulation and access for all modes of travel by balancing the need to move people and freight efficiently through the neighborhood with the need for increased accessibility and safety for pedestrians and bicyclists.
- SLU-P25** Encourage improvements to Mercer and Valley Streets that support development of South Lake Union Park, improve neighborhood circulation for all modes, and move people and freight efficiently through this corridor.

PARKS & OPEN SPACE GOAL

- SLU-G10** Parks and open spaces provide an obvious and inviting purpose, accessible to and meeting the needs of an increasingly diverse neighborhood as it grows and changes.

PARKS & OPEN SPACE POLICIES

- SLU-P26** Support South Lake Union Park as a local and regional waterfront attraction that celebrates the area's natural history and maritime heritage.
- SLU-P27** Support Cascade Playground and related facilities as a community resource and model for sustainable parks development.
- SLU-P28** Support Denny Park's historic character while identifying opportunities to encourage more use of the park.
- SLU-P29** Consider a variety of tools, including regulatory measures and joint projects with public agencies and private organizations, to support existing park and open space projects and to provide for new open spaces to support the growth of the neighborhood.
- SLU-P30** Encourage the acquisition and development of public or private spaces that provide for active play and recreation.
- SLU-P31** Use visual and physical connections between open spaces, adjacent streets, and surrounding activities to stimulate positive social interactions.

SLU-P32 Identify opportunities for alternatives to traditional open spaces, including green streets and recognition and use of Lake Union as recreation and open space.

HOUSING GOALS

SLU-G11 A wide range of housing types is integrated into the community, accommodating households that are diverse in their composition and income.

SLU-G12 Housing in South Lake Union is affordable for and attractive to workers in South Lake Union, to enable people to live near their jobs.

HOUSING POLICIES

SLU-P33 Provide incentives to encourage housing for people across a range of incomes in a variety of housing types, particularly in mixed-income buildings.

SLU-P34 Encourage affordable housing units throughout the community through new construction and preservation of existing buildings.

SLU-P35 Encourage both rental and ownership housing.

SLU-P36 Promote housing, amenities, and services, including schools and childcare, community center, library programs, and other public services that promote a healthy community and that will attract more families to move into the South Lake Union neighborhood.

SLU-P37 Encourage employers to develop and participate in strategies that allow employees to live near their work.

SLU-P38 Allow housing and businesses throughout South Lake Union to provide opportunities for people to work and live in the neighborhood.

SLU-P39 Identify locations within South Lake Union where housing could be particularly concentrated to create viable urban residential communities.

SLU-P40 Promote the development of live-work housing, especially when designed to meet the special needs of groups like artists and their families.

SUSTAINABILITY GOAL

SLU-G13 A neighborhood that acts as a model for sustainable redevelopment.

SUSTAINABILITY POLICIES

SLU-P41 Encourage low-impact development and activities that can control consumption of resources, improve public health and safety, and provide for multiple environmental benefits.

- SLU-P42** Encourage careful stewardship of water quality in Lake Union, including strategies to improve the quality of water flowing into the lake.
- SLU-P43** Provide for a stable and reliable supply of electrical power to South Lake Union, which has facilities with unique load and service requirements, such as high-technology and biotechnology research laboratories.
- SLU-P44** Explore new sources of energy for heating and cooling, renewable energy, distributed cogeneration, and energy conservation, at the building, block, and neighborhood level.
- SLU-P45** Encourage building designs that allow for public view corridors through the neighborhood to Lake Union and the Space Needle and natural light at street-level.
- SLU-P46** Seek to increase tree coverage, reintroduce native plant species into the neighborhood, and provide for additional wildlife habitat appropriate to the urban environment.

South Park

GOALS

- SP-G1** A great place to live and work.
- SP-G2** A community where neighbors are encouraged to know one another and join in making decisions about the future of the South Park community.
- SP-G3** A community inviting to households with children, where people value children's safety and education.
- SP-G4** A neighborhood where residents of all cultures, incomes, and ages are welcome.
- SP-G5** A "people place" at all times of the day.

POLICIES

- SP-P1** Collaborate with South Park residents, businesses and organizations in future planning efforts that impact South Park.
- SP-P2** Encourage community-building opportunities for South Park's residents.
- SP-P3** Encourage interjurisdictional partnerships that address issues in South Park that transcend jurisdictional boundaries.

LAND USE GOAL

- SP-G6** Maintain and enhance South Park's residential character.

LAND USE POLICIES

- SP-P4** Seek to maintain industrial land for industrial and commercial uses.
- SP-P5** Seek to maintain residential land for residential uses. Multifamily and split zoned lots, adjacent to commercial zoning along 14th Avenue South, may be rezoned to commercial zoning to provide increased space for parking that supports commercial uses.

TRANSPORTATION GOAL

- SP-G7** A community where people feel safe and comfortable walking, riding a bicycle, using public transportation, or driving a vehicle, and where streets are pleasant and public spaces are safe.

TRANSPORTATION POLICIES

- SP-P6** Seek to promote an active, attractive, accessible pedestrian environment.
- SP-P7** Consider opportunities to increase accessibility within the neighborhood, including across Highway 99.

HOUSING GOAL

- SP-G8** The development of new, and the preservation of existing, single-family detached housing affordable to low-income households.

HOUSING POLICIES

- SP-P8** Encourage the maintenance of existing housing.
- SP-P9** Work in partnership among various levels of government to address low-income housing needs that transcend jurisdictional boundaries.

CAPITAL FACILITIES GOAL

- SP-G9** Public facilities that reflect South Park's residential character and role as the service center for surrounding areas.

CAPITAL FACILITIES POLICIES

- SP-P10** Continue seeking grass-roots involvement in identifying and siting desired capital projects and public facilities.
- SP-P11** Continue to provide for the maintenance of public facilities within South Park.

UTILITIES POLICIES

- SP-P12** Continue seeking grass-roots involvement in siting utility facilities for South Park.
- SP-P13** Seek to provide timely and effective notification to other interested utilities of planned road and right-of-way trenching, maintenance, and upgrading activities, to minimize the cost and public inconvenience of road and right-of-way trenching activities.
- SP-P14** Seek to coordinate utility capital expenditure planning with capital investment planning by County departments, where appropriate.

ENVIRONMENT GOAL

- SP-G10** A community where residents and businesses practice responsible stewardship of the environment.

ENVIRONMENT POLICIES

- SP-P15** Seek to include quality environmental practices in the execution of public works in South Park.
- SP-P16** Support the efforts of local organizations that are working to create a healthier environment.

ECONOMIC DEVELOPMENT POLICY

- SP-P17** Seek training opportunities for South Park residents that will help them to compete for meaningful and productive employment, earn a living wage, and meet the needs of business.

CULTURAL RESOURCES POLICY

- SP-P18** Encourage public art within South Park.

University Community Urban Center

GOALS

- UC-G1** Stable residential neighborhoods that can accommodate projected growth and foster desirable living conditions.
- UC-G2** Vibrant commercial districts serving local needs and offering regional attractions.



- UC-G3** An efficient transportation system that balances different modes, including public transit, pedestrian, bicycle, and automobile, and minimizes negative impacts to the community.
- UC-G4** A community in which the housing needs and affordability levels of major demographic groups, including students, young adults, families with children, empty nesters, and seniors, are met and which balances homeownership opportunities with rental unit supply.
- UC-G5** A community with a wide range of neighborhood recreation facilities and open space and which meets the Comprehensive Plan's open space goals.
- UC-G6** A community that builds a unique physical identity on its historical and architectural resources, attractive streets, university campus, and special features.
- UC-G7** An urban center that is home to the University of Washington, the region's foremost educational institution, which is expanding to meet new challenges while enhancing the surrounding community.
- UC-G8** A community in which public education resources are readily available.
- UC-G9** A community that is regionally recognized for its arts and cultural activities and that uses cultural activities as a community building asset.
- UC-G10** An integrated social service delivery network that serves the entire community.
- UC-G11** A community where people are and feel safe.
- UC-G12** A community where the historic resources, natural elements, and other elements that add to the community's sense of history and unique character are conserved.
- UC-G13** A community that supports innovation, discovery, and job creation through collaboration between businesses and the university.

POLICIES

- UC-P1** In pursuit of Comprehensive Plan Housing element policies, encourage lower-density housing types in the Roosevelt, University Heights, and Ravenna areas of the community, with options at a variety of affordability levels.
- UC-P2** South of 50th and west of 15th, encourage high-quality development with a variety of building types, enhancing a vibrant mixed-use area with excellent proximity to the University and to the Sound Transit Light Rail station.
- UC-P3** Continue to strengthen pedestrian-oriented retail on University Way through physical improvements to the street and sidewalk and encouraging property and business owners to improve frontages. Encourage new improvements to University Way north of NE 50th Street.
- UC-P4** Strengthen a diverse mix of retail and commercial activities on NE 45th Street and Roosevelt Avenue NE.

- UC-P5** Support the University Village Shopping Center’s activities in a way that furthers economic and housing goals while requiring mitigation of significant and cumulative impacts according to SEPA.
- UC-P6** Encourage the development of retail businesses that serve local needs on 25th Avenue NE, and encourage the redevelopment of a diverse mix of housing and compatible retail, where appropriate, in adjacent areas.
- UC-P7** Involve the community and contiguous neighborhoods in the monitoring of traffic, and the identification of actions needed to preserve the multimodal capacity of the principal arterial streets, to accommodate projected growth and protect residential streets from the effects of through-traffic.
- UC-P8** In pursuit of Comprehensive Plan Policies Transportation Policies, emphasize comfortable, safe, attractive pedestrian and bicycle access throughout the center, especially those routes identified in citywide modal plans
- UC-P9** Take advantage of Sound Transit improvements and coordinate local transportation needs and impacts and facilitate intermodal connections, such as bus, streetcar, bicycle, pedestrian travel, and surface vehicle traffic.
- UC-P10** Work with King County Metro and Community Transit to create efficient bus circulation. Address bus layover impacts, bus routing, and transfer issues as well as street improvements to facilitate transit.
- UC-P11** Carefully manage parking to provide needed accessibility while minimizing traffic and on-street parking impacts when considering on-street parking actions, off-street parking requirements for new development, and public parking development. Strongly discourage “park-and-ride” parking for commuters.
- UC-P12** Employ a variety of strategies to effectively provide for identified housing needs, including preservation of some existing housing while accommodating growth with a diversity of unit types, sizes, and affordability.
- UC-P13** To maintain safe housing for all, and to reduce conflicts between student and non-student neighbors, encourage collaboration between residents, the City, and the university to enforce code requirements.
- UC-P14** Employ a variety of strategies to bring housing development to the affordability levels identified in the Housing element of the Comprehensive Plan, including development partnerships, zoning modifications, and subsidies.
- UC-P15** In order to serve existing residents to the north and emerging residential neighborhoods, support the community services cluster roughly along NE 50th Street, which includes a variety of public, recreational, educational, community, and human services, plus churches, playfields, and other facilities.
- UC-P16** Employ a variety of strategies to increase open space, such as park acquisition through a major open space funding program, improvement of and better access to existing assets, adding open space functions in rights-of-way, and creation of small spaces with new development.

- UC-P17** Encourage the establishment of a local open space fund that can be used to purchase and improve small parcels when the opportunity arises, and to support programming and maintenance costs.
- UC-P18** Provide better physical connections from the University District to the UW campus, with particular emphasis on the campus entrance at NE 43rd Street and, more broadly, opening the west edge of central campus along 15th Avenue NE.
- UC-P19** South of NE 50th Street and west of 15th Avenue NE, create a network of open spaces integrated with development, including improved sidewalks and pedestrian pathways that increase accessibility through and along long blocks. Provide open space and recreation facilities for seniors.
- UC-P20** Pursue the creation of a centrally located, flexible open space, ideally within two blocks of the Sound Transit light rail station at Brooklyn and 43rd. Surround this open space with active uses, and manage it to ensure that it is a positive addition to the neighborhood.
- UC-P21** In the University Way-15th Avenue NE corridor between NE 55th Street and NE 41st Street, encourage the provision of more sidewalk cafes, alley activation, and street-oriented public space through both public and private investment.
- UC-P22** In the Ravenna Urban Village, seek to protect and enhance natural areas and features.
- UC-P23** Seek to preserve and enhance the following design characteristics within the community: pedestrian orientation and visual interest to the pedestrian, high-quality, human-scaled design details in larger buildings, streetscape continuity on commercial corridors, integration between the UW campus and the surrounding community, buildings with attractive open space and low-rise multifamily development that fits with the design character of adjacent single-family houses.
- UC-P24** Enhance gateways into the University Community, especially at NE 45th St and Seventh Avenue NE, NE 50th Street at Roosevelt Avenue NE, NE 45th Street at 15th Avenue NE, the Sound Transit light rail station, the “landing” of the University Bridge at NE 40th Street, 25th Avenue NE at NE 55th Street, and NE 45th Street at 25th Avenue NE. “Gateways” means visual enhancements that signify entries into the community, such as improved landscaping, signage, artwork, or architectural features.
- UC-P25** Accommodate new university growth in a way that benefits the surrounding community.
- UC-P26** Work to connect and integrate the campus and the community visually, physically, socially, and functionally.
- UC-P27** Ensure that the University Community plays an active role in the UW’s Campus Master Plan on subjects of mutual interest.
- UC-P28** Pursue opportunities to work with Seattle Public School District #1 in locating a public school in the community, capitalizing on the area’s excellent accessibility and proximity to the University of Washington.

- UC-P29** Work with Seattle Public School District #1 to ensure appropriate, equitable school resources are available in the community, including after-school activities and facilities.
- UC-P30** Encourage the local coordination of arts and cultural activities, including museums, theaters, commercial activities, galleries, classes, performance halls, arts groups, and informal performance groups, for the mutual enhancement of those efforts.
- UC-P31** Provide the opportunity for local public involvement in City-sponsored art projects and the design of major public facilities.
- UC-P32** Ensure that the full range of cultural activities and backgrounds is represented in publicly funded arts.
- UC-P33** Foster the coordinated efforts of local social service providers to identify and meet the specific service delivery needs in the urban center.
- UC-P34** Encourage effective partnerships between service providers and integrate these efforts into other community improvement activities.
- UC-P35** Place a high priority on controlling illegal activities on streets and in public spaces.
- UC-P36** Encourage legitimate uses and a sense of ownership in parks and public spaces.
- UC-P37** Support public safety through urban design.
- UC-P38** Seek to conserve the special historic and cultural resources in the University Community including significant structures on commercial corridors, registered landmarks, and significant public structures.
- UC-P39** Identify and conserve areas of special design character, such as Greek Row and the 17th Avenue NE boulevard.

CAPITAL FACILITIES & UTILITIES

The goals and policies of the Capital Facilities and Utilities elements of the Comprehensive Plan express the vision of the University Community Urban Center.

Wallingford

URBAN VILLAGES GOAL

- W-G1** A neighborhood with a vital commercial district serving the residential core.

URBAN VILLAGES POLICIES

- W-P1** Protect the character and integrity of Wallingford's single-family areas.

- W-P2** Discourage single purpose residential development in the key business district along 45th Avenue North and NE.
- W-P3** Allow for consideration of future downzones to encourage small-lot or cottage development and affordable housing types or to respond to unanticipated development pressure.
- W-P4** Use Wallingford Neighborhood Design Guidelines for reviewing commercial and multifamily development to encourage design that is consistent with the neighborhood's character, while maintaining and promoting a vital business community.
- W-P5** Strive to create open space opportunities in underserved areas.
- W-P6** Give significant attention to infrastructure within the urban village and for heavily used facilities serving the urban village.
- W-P7** Inasmuch as the Wallingford Residential Urban Village has substantially exceeded its household growth target, special L3 and L4 locational criteria for the evaluation of rezones to the L3 and L4 designations inside of urban villages shall not apply in the Wallingford Residential Urban Village.

HOUSING GOAL

- W-G2** A community with housing and amenities that support a population of diverse incomes, ages, and other social characteristics.

HOUSING POLICIES

- W-P8** Promote a high rate of homeownership within the Wallingford area.
- W-P9** Seek to make a wide variety of housing types available to meet the needs of diverse populations and families and explore options to provide affordable homes.
- W-P10** Encourage a wide range of public facilities and other amenities such as parks, open space, library, and meeting rooms that encourage and promote neighborhood stability.
- W-P11** Encourage development of housing for a wide range of incomes.
- W-P12** Encourage retention of a wide range of age groups residing in Wallingford.
- W-P13** Allow development of home businesses that do not adversely affect the character of the residential community.
- W-P14** Encourage the development of accessory dwelling units in the community as a housing affordability strategy.

TRANSPORTATION GOAL

W-G3 A neighborhood of pleasant and exciting streets that promote walking, transit use, and interactions between neighbors.

TRANSPORTATION POLICIES

W-P15 Strive to create an efficient street network for cars, trucks, pedestrians, buses, and bicycles and to promote safety for all modes.

W-P16 Strive to eliminate local safety hazards to pedestrians and traffic and to discourage cut-through traffic on residential streets.

W-P17 Work to provide convenient access to, and network connectivity of, the transit system.

W-P18 Seek to provide for commercial parking availability, and use of existing parking, and to eliminate spillover parking in residential areas.

W-P19 Strive to create streets with sidewalks that are pleasant public places with safe and convenient street crossings and a balanced interaction between pedestrian, bicycle, car, bus, and truck traffic.

BUSINESS HEALTH GOAL

W-G4 A neighborhood that maintains and promotes a vital business community.

BUSINESS HEALTH POLICIES

W-P20 Encourage efficient utilization of existing parking opportunities along the business corridor.

W-P21 Strive to maintain, promote, and beautify a vital business community that is clean, safe and accessible.

COMMUNITY BUILDING GOAL

W-G5 A neighborhood that feels like “a small town in the big city.”

COMMUNITY BUILDING POLICIES

W-P22 Encourage neighborhood-based efforts to enhance a sense of community and individual empowerment and strengthen community organization.

W-P23 Work to provide excellent city-neighborhood collaboration and communication.

WALLINGFORD Residential Urban Village

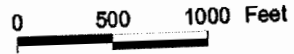
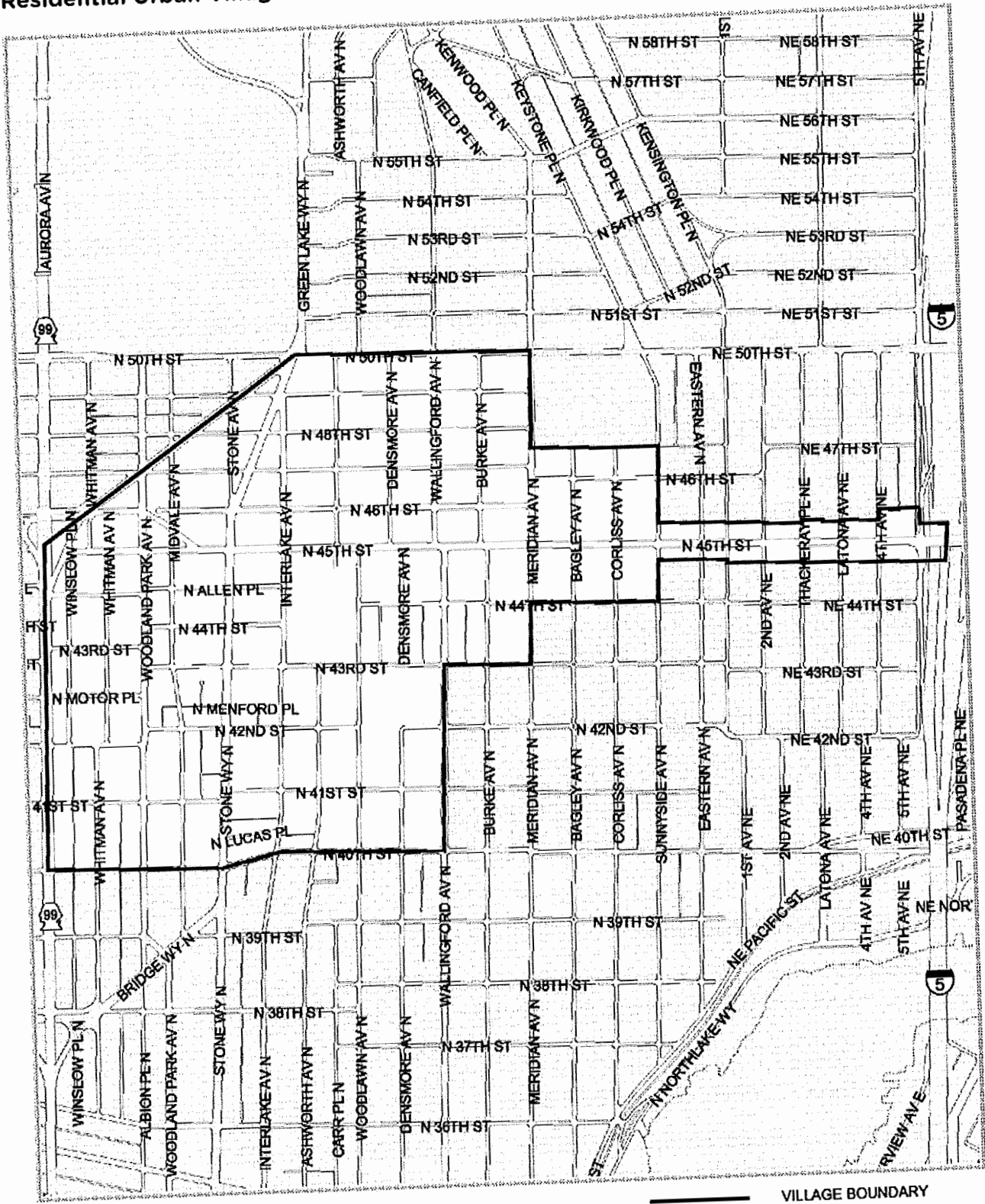

VILLAGE BOUNDARY
EDGE OF PAVEMENT

- W-P24** Promote volunteerism to help make best use of our most valuable resource—our knowledgeable and caring community members.

HUMAN SERVICES POLICIES

- W-P25** Encourage human services in Wallingford that are closely attuned to the neighborhood’s internal needs yet recognize the needs of the larger community.
- W-P26** Encourage early communication and notification and meaningful participation by Wallingford residents in the siting of human service facilities.

SPECIAL OPPORTUNITIES GOAL

- W-G6** A neighborhood with public facilities that are assets to both the neighborhood and the service providers.

SPECIAL OPPORTUNITIES POLICIES

- W-P27** Strive to involve and consider the Wallingford community in planning for the use of all public facilities in Wallingford.
- W-P28** Encourage agencies responsible for public facilities to maintain and rehabilitate existing public facilities as necessary to make them assets to the neighborhood and to preserve their historic value.
- W-P29** Consider acquisition of facilities owned by other public agencies, such as the Seattle school district, as they become available based on viability for long-term use.

SOUTH WALLINGFORD GOAL

- W-G7** A neighborhood south of N/NE 40th Street that reflects the residents’ desire for a pedestrian-friendly neighborhood, with strong connections to the Wallingford Urban Village and to public spaces along the shoreline, while maintaining the viability of the existing marine-industrial and commercial activities.

SOUTH WALLINGFORD POLICIES

- W-P30** Maintain the shoreline’s marine industrial zoning in order to preserve the water-dependent use and the working waterfront character of the Wallingford shoreline.
- W-P31** Provide opportunities for small, pedestrian-oriented businesses in South Wallingford while preserving the economic vitality of existing businesses and opportunities for their reasonable redevelopment.
- W-P32** Pursue opportunities to provide public access between the residential community and the shoreline area.

- W-P33** Strive to preserve existing views of Lake Union and Downtown Seattle from viewpoints and parks.
- W-P34** Control impacts of regional traffic on South Wallingford's residential, commercial, and recreational areas.
- W-P35** Work to enhance bicycle and pedestrian access between the upland portion of the neighborhood and the Burke-Gilman Trail and shoreline.

West Seattle Junction

COMMUNITY CHARACTER GOAL

- WSJ-G1** A small-town community with its own distinct identity comprised of a strong single-family residential community and a vibrant mixed-use business district serving the surrounding residential core.

COMMUNITY CHARACTER POLICIES

- WSJ-P1** Seek to maintain and enhance a compact mixed-use commercial core, with small-town character, located between 41st and 44th Avenues SW and SW Genesee Street and SW Edmunds Street, by encouraging improved traffic flow, pedestrian safety and amenities, and architectural image.
- WSJ-P2** Target city investments into areas where growth is expected to occur, especially within the village "core" located between 41st and 44th Avenues SW and SW Genesee Street and SW Edmunds Street.

ECONOMIC DEVELOPMENT WITHIN THE COMMERCIAL CORE GOAL

- WSJ-G2** A vibrant center of shopping, dining, and cultural opportunities that supports both daytime and nighttime activity.

ECONOMIC DEVELOPMENT WITHIN THE COMMERCIAL CORE POLICIES

- WSJ-P3** Encourage attractive, higher-density mixed-use development within the commercial core at a height compatible with the neighborhood's small-town scale.
- WSJ-P4** Strive to balance the goal of a compact urban village with the need for adequate parking, traffic circulation, and pedestrian safety on neighborhood streets.
- WSJ-P5** Seek to reinforce pedestrian orientation, enhance the architectural character of the area, and promote interaction between the community, property owners, and developers to encourage new buildings that contribute to and enhance the Junction's character.



WSJ-P6 Encourage a human-scale design of buildings and public spaces to be accessible to pedestrians, safe, well lit, and clean.

WSJ-P7 Encourage efforts to maintain and preserve local landmark buildings within the business district.

FAUNTLEROY GATEWAY INTO THE JUNCTION GOAL

WSJ-G3 A community gateway near Fauntleroy Way and Oregon Street that reflects the character of the rest of the neighborhood, presents a positive image, and provides a safe and pleasant pedestrian environment, efficient traffic flow, and a pleasant and positive aesthetic appearance.

FAUNTLEROY GATEWAY INTO THE JUNCTION POLICIES

WSJ-P8 Seek to integrate Fauntleroy Way into the neighborhood physically, aesthetically, and operationally while, at the same time, maintaining its arterial functions.

WSJ-P9 Seek to enhance pedestrian safety and improve pedestrian circulation along Avalon Way, Fauntleroy Way, and SW Alaska Street from 35th Avenue SW to California Avenue SW.

TRANSPORTATION GOAL

WSJ-G4 A neighborhood that facilitates movement of people and goods with a particular emphasis on increasing safety, supporting the economic centers, and encouraging a full range of transportation choices.

TRANSPORTATION POLICIES

WSJ-P10 Enhance pedestrian access and vehicular and bicycle mobility throughout the neighborhood, with particular attention to the Junction commercial core, the Fauntleroy Way Corridor, the California Avenue SW Corridor, and the 35th Avenue SW Corridor.

WSJ-P11 Encourage pedestrian and bicycle linkages among the three West Seattle Junctions (Admiral, West Seattle, and Morgan) and to and from other Seattle neighborhoods via the Spokane Street corridor.

WSJ-P12 Strive to protect the residential neighborhoods surrounding the West Seattle Junction from traffic impacts.

HOUSING & LAND USE GOAL

WSJ-G5 A community with housing and amenities that support a population of diverse incomes, ages, and other social characteristics.

HOUSING & LAND USE POLICIES

WSJ-P13 Maintain the character and integrity of the existing single-family areas.

WSJ-P14 Encourage programs that help low- and fixed-income people, especially seniors, retain ownership of their homes.

WSJ-P15 Encourage opportunities to provide affordable market-rate housing in the neighborhood for Junction workers.

PARKS & OPEN SPACE GOALS

WSJ-G6 A desirable place for families with a safe and attractive residential neighborhood served by a variety of park and recreation facilities.

WSJ-G7 A neighborhood with a cohesive identity and aesthetics, which respects the urban forest and native habitat.

PARKS & OPEN SPACE POLICIES

WSJ-P16 Encourage the provision of open spaces in conjunction with pedestrian and bicycle linkages throughout the neighborhood.

WSJ-P17 Seek opportunities to reclaim unneeded portions of street right-of-way to develop open space and trails where appropriate and explore opportunities to support the “open space lattice” concept.

WSJ-P18 Explore opportunities within the business district to create community gathering places.

WSJ-P19 Promote greening and beautification of the neighborhood through local citizen participation.

WSJ-P20 Enhance the urban forest within existing parks and open space areas.

WSJ-P21 Support the maintenance and restoration of native habitat and species in existing parks, open spaces, and street right-of-ways.

CULTURAL ARTS GOAL

WSJ-G8 A neighborhood community with a distinctive flavor in arts and culture, yet integrated into the overall arts and cultural community in West Seattle.

CULTURAL ARTS POLICIES

WSJ-P22 Support the provision of public art throughout the Junction.

WSJ-P23 Strive to integrate art into the business district and at new open space sites.

WEST SEATTLE JUNCTION Hub Urban Village

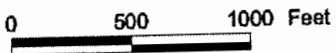
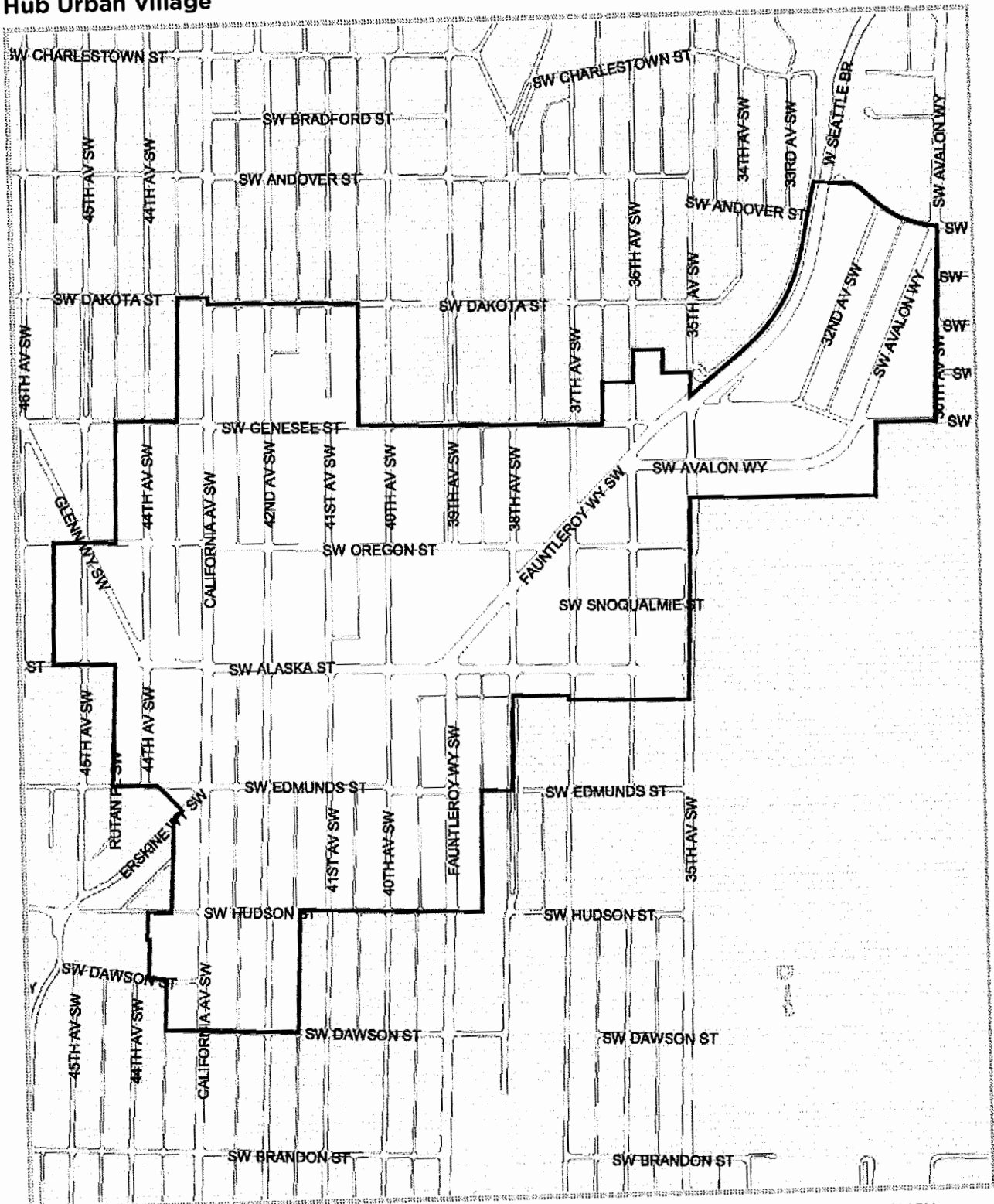

VILLAGE BOUNDARY
 EDGE OF PAVEMENT



WSJ-P24 Encourage multicultural outreach for and participation in the arts throughout West Seattle.

HUMAN DEVELOPMENT & PUBLIC SAFETY GOAL

WSJ-G9 A neighborhood that recognizes and supports the diverse human development needs and safety concerns of its changing population.

HUMAN DEVELOPMENT & PUBLIC SAFETY POLICIES

WSJ-P25 Encourage human services providers to work closely with neighborhood organizations in developing programs that benefit clients and the larger community.

WSJ-P26 Seek to improve communication between people, organizations, and communities dealing with human development and safety issues.

WSJ-P27 Promote the use of good environmental design to improve the safety of new open space sites, pedestrian trails, and new development.

CAPITAL FACILITIES GOAL

WSJ-G10 A neighborhood with public facilities that are assets to both the neighborhood and the service providers.

CAPITAL FACILITIES POLICIES

WSJ-P28 Seek to involve the Junction community in planning efforts for the use of the public facilities in the planning area.

WSJ-P29 Encourage the maintenance and continued use of public facilities as necessary to ensure they remain assets to the neighborhood and preserve their historic value.

WSJ-P30 Encourage the retention and re-use of public facilities within the Junction neighborhood that would serve long-term goals and needs of the community.

Westwood/Highland Park

COMMUNITY CHARACTER GOAL

W/HP-G1 A diverse community with two distinct areas, Westwood and Highland Park, composed of a mix of single- and multifamily residential areas, significant public facilities, regional and local commercial businesses, and natural resource opportunities that together offer a variety of choices for its residents.

COMMUNITY CHARACTER POLICIES

- W/HP-P1** Encourage and strengthen a community-wide network of safe and convenient connections that unite Westwood and Highland Park and link major open spaces, transit facilities, commercial areas, schools, and other community facilities.
- W/HP-P2** Seek to reclaim and enhance a major natural resource, Longfellow Creek, as a central linkage promoting recreational, environmental, and historical themes.
- W/HP-P3** Strive to preserve existing single-family areas and increase the attractiveness of multifamily residential areas that offer a range of attractive and safe housing choices affordable to a broad spectrum of the entire community.
- W/HP-P4** Promote a system-wide and comprehensive transportation approach for West Seattle that strongly encourages safe, convenient, and efficient local improvements that serve the community.
- W/HP-P5** Seek to strengthen the neighborhood's economic core, Westwood Town Center (a regional and local retail/service center) and the 16th Avenue Business District.
- W/HP-P6** Encourage a civic center and recreational complex anchor that serves the entire community for the Denny/Sealth Recreation Area.

ECONOMIC DEVELOPMENT GOAL

- W/HP-G2** A vibrant center of shopping that serves and attracts local residents within both communities.

ECONOMIC DEVELOPMENT POLICIES

- W/HP-P7** Seek to revitalize the Triangle Commercial Core (16th Avenue SW Business District and Westwood Town Center) through pedestrian amenities, parking management, and transit enhancements to create an anchor business district that attracts and serves local residents.
- W/HP-P8** Encourage programs that promote the local business community through collaborative marketing activities and neighborhood celebration events.

URBAN DESIGN & COMMUNITY ANCHORS GOAL

- W/HP-G3** A community that reflects the unique local character of the Westwood and Highland Park neighborhoods, with community anchors, a safe and pleasant pedestrian environment, and a positive aesthetic appearance.

URBAN DESIGN & COMMUNITY ANCHORS POLICIES

- W/HP-P9** Encourage physical gateway improvements at key entry points and within the business districts that identify Seattle's Westwood and Highland Park neighborhoods.
- W/HP-P10** Seek to create a sense of place along major streets that visually and functionally promotes the rights of pedestrians through decorative crosswalks, pavings, and landscaping at key intersections.
- W/HP-P11** Promote a sense of community identity and pride through the use of public artwork, sculptures, and streetscape improvements along major arterials.

TRANSPORTATION & PEDESTRIAN SYSTEMS GOAL

- W/HP-G4** A neighborhood that facilitates movement of people and goods with a particular emphasis on increasing pedestrian safety and access, supporting the economic centers, and encouraging a full range of convenient transportation choices to residents.

TRANSPORTATION & PEDESTRIAN SYSTEMS POLICIES

- W/HP-P12** Seek to enhance pedestrian access and vehicular and bicycle mobility throughout the neighborhood.
- W/HP-P13** Encourage the coordination of transportation capital improvements across all of West Seattle.
- W/HP-P14** Seek to improve arterial streets that promote pedestrian safety and mobility throughout the neighborhood.
- W/HP-P15** Promote the safe and convenient operation of the Delridge Way SW corridor by seeking to improve traffic flow, intersection operation, transit accessibility, and pedestrian and bicycle facilities.
- W/HP-P16** Seek to establish excellent east-west pedestrian linkages with pedestrian improvements along SW Trenton Street and SW Thistle Street.
- W/HP-P17** Seek excellent internal east-west transit linkages within the neighborhood.

HOUSING GOAL

- W/HP-G5** A community with both single-family and multifamily residential areas and the amenities to support the diverse population.

HOUSING POLICIES

- W/HP-P18** Seek to maintain the character and integrity of the existing single-family areas.

WESTWOOD/HIGHLAND PARK Residential Urban Village

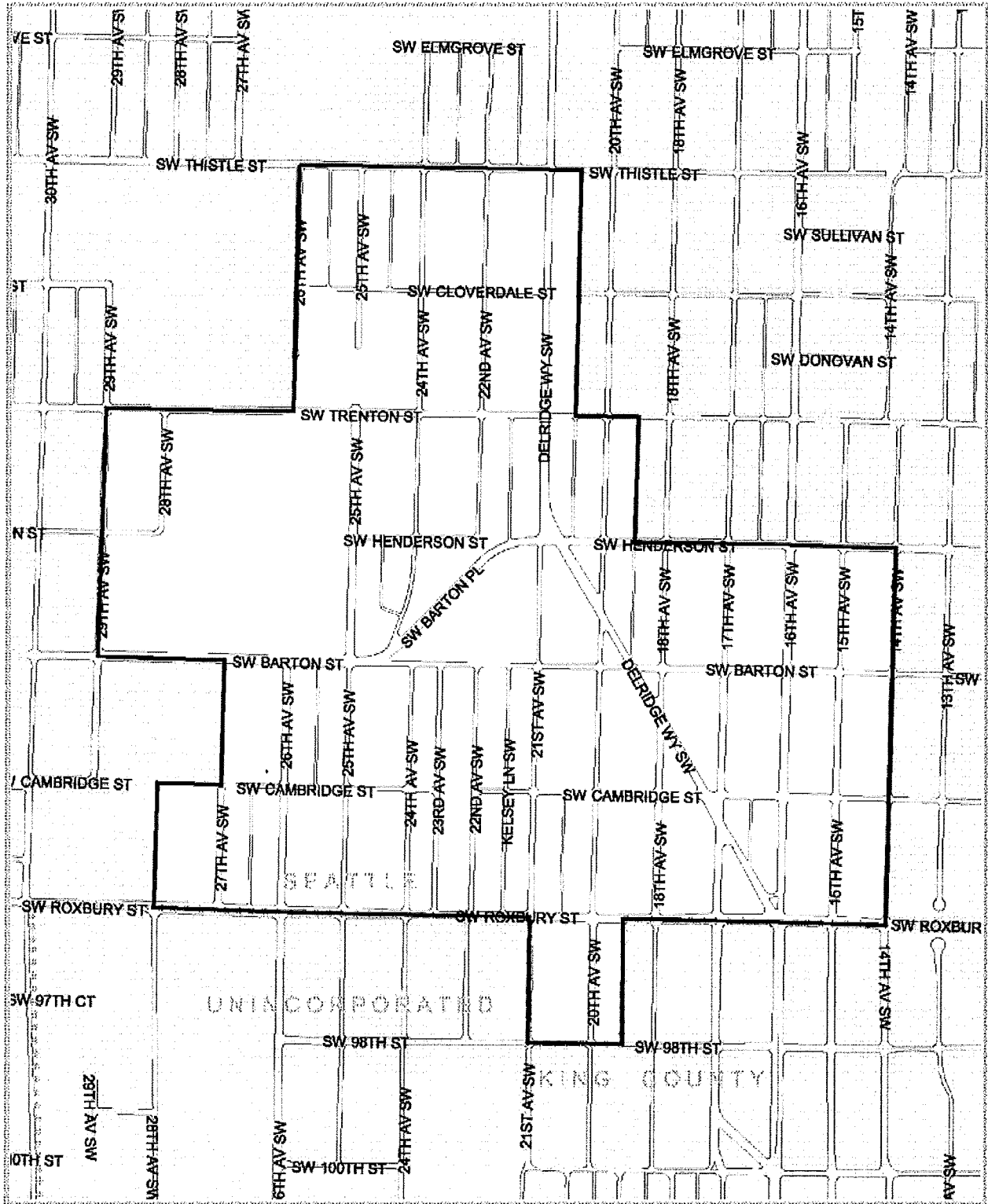

 VILLAGE BOUNDARY
 EDGE OF PAVEMENT

PARKING POLICIES

- R-TP3** Promote the equitable distribution of parking on commercial and residential access streets to provide a safe flow of traffic relative to traffic volume and optimize the amount of on-street parking.
- R-TP4** Prioritize parking in commercial areas for business customers.

SAFETY GOAL

- R-TG8** Street design and traffic control on principal and minor arterials should provide for pedestrian safety and promote a healthy walking environment.

SAFETY POLICIES

- R-TP5** Design traffic signals, crosswalks, and sidewalks to improve pedestrian safety and encourage walking.
- R-TP6** Promote site planning that reduces conflicts between pedestrians and vehicles.

LIGHT RAIL GOAL

- R-TG9** Promote and support the integration of the Sound Transit Light Rail Station into the transportation network of the Roosevelt Urban Village.

LIGHT RAIL POLICIES

- R-TP7** Promote a surface transit routing scheme that provides convenient, effective, and frequent access to the light rail station.
- R-TP8** Promote elements in the design of the light rail station that provide functional loading and unloading for vehicles, including surface transit.
- R-TP9** Promote improvements of pedestrian and bicycle facilities to ensure safe and convenient access to the light rail station.
- R-TP10** Protect on-street parking for residents and neighborhood commercial patrons from light rail users who commute to the station by automobile.

HOUSING GOALS

- R-HG1** Protect and maintain the architectural heritage of Roosevelt's Craftsman, bungalow, and Tudor-style housing while embracing growth of well-designed buildings of an appropriate scale.
- R-HG2** Create housing types that can provide housing opportunities for a wide range of residents and households with varying incomes and housing needs.

ROOSEVELT Residential Urban Village

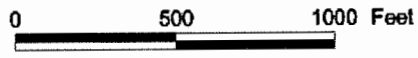
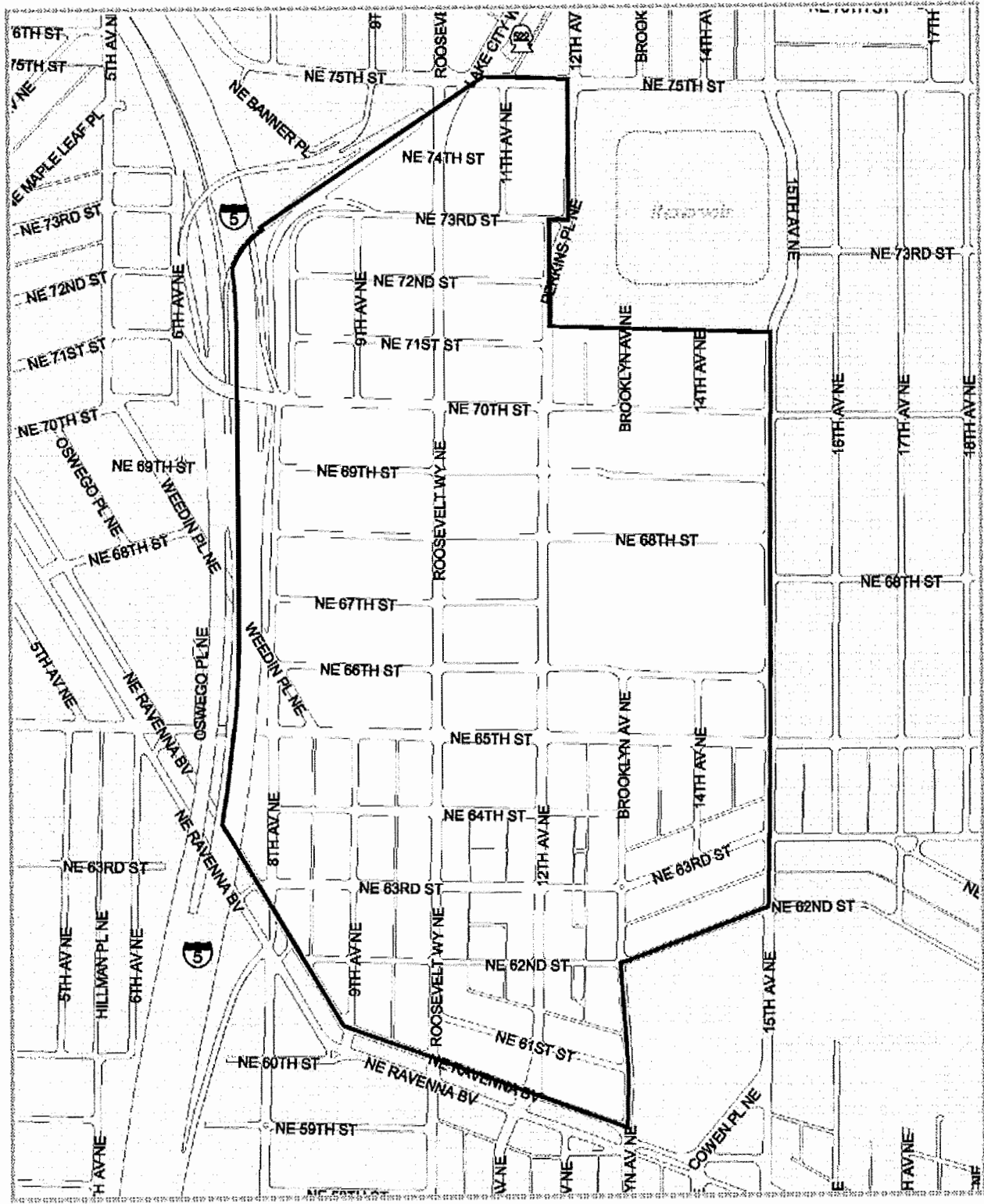

VILLAGE BOUNDARY
 EDGE OF PAVEMENT

- W/HP-P19** Encourage new housing development that serves a range of income levels.
- W/HP-P20** Promote the attractiveness of higher-density residential areas through the enhancement of basic infrastructure and amenities.
- W/HP-P21** Encourage quality design in town houses, cottage houses, and accessory dwelling units.
- W/HP-P22** Promote mixed-use projects featuring quality housing opportunities within the Triangle Commercial Core.
- W/HP-P23** Seek to ensure safe and well-maintained housing.
- W/HP-P24** Support the Seattle Housing Authority and other nonprofits in the development of high-quality housing that serves the low-income community.
- W/HP-P25** Encourage new residential development through zoning tools such as Residential Small Lot Development, and incentives in multifamily zones and commercial zones.

PARKS & OPEN SPACE GOAL

- W/HP-G6** A community with accessible and functional parks, open space, recreational facilities, and natural systems that are connected to serve Westwood and Highland Park's diverse population.

PARKS & OPEN SPACE POLICIES

- W/HP-P26** Strive to reclaim and enhance the Longfellow Creek corridor by creating a comprehensive trail system that enhances public access and links the neighborhoods to the existing parks and other trail systems and other community attractions.
- W/HP-P27** Encourage direct public access through observation points to Longfellow Creek and its environs that features the importance of natural systems and the neighborhood's geological history.
- W/HP-P28** Seek to coordinate the Longfellow Creek Legacy Trail Project with the Delridge neighborhood's creek trail system to help achieve a coordinated community trail system.
- W/HP-P29** Seek to acquire property for small parks and open space to serve the community.
- W/HP-P30** Support community-wide recreational opportunities for the Denny/Sealth Recreation Area.

HUMAN DEVELOPMENT & PUBLIC SAFETY GOAL

- W/HP-G7** A neighborhood that recognizes and supports the diverse human development needs and safety concerns of its changing and diverse population.



HUMAN DEVELOPMENT & PUBLIC SAFETY POLICIES

W/HP-P31 Seek to improve communication between people, organizations, and communities dealing with human development and safety issues.

W/HP-P32 Promote the use of Crime Prevention Through Environmental Design (CPTED) techniques in the development of parks, open spaces, pedestrian/bike trails, and traffic improvements.



Appendices

Growth Strategy Appendix

Growth Strategy Appendix Figure A-1

Housing Units in Seattle, 1995–2015

	1995 Year-End Total Housing Units	1996–2015 Housing Units Built (Net)	20-Year Housing Unit Growth Rate 1996–2015	2015 Year-End Total Housing Units*
Urban Centers	47,040	33,167	71%	80,322
Downtown Urban Center	10,618	13,478	127%	24,347
First Hill/Capitol Hill Urban Center	21,562	7,907	37%	29,619
University District Urban Center	6,583	3,168	48%	9,802
Northgate	3,559	1,167	33%	4,535
South Lake Union	809	3,954	489%	4,536
Uptown	3,909	3,493	89%	7,483
Hub Villages	14,253	10,654	75%	24,505
Ballard	4,772	3,963	83%	9,168
Bitter Lake Village	2,364	1,380	58%	3,257
Fremont	2,194	1,111	51%	3,200
Lake City	1,391	1,138	82%	2,546
Mt. Baker (North Rainier)	1,568	875	56%	2,454
West Seattle Junction	1,964	2,187	111%	3,880
Residential Villages	29,348	12,731	43%	42,174
23rd & Union-Jackson	3,342	1,979	59%	5,451

	1995 Year-End Total Housing Units	1996–2015 Housing Units Built (Net)	20-Year Housing Unit Growth Rate 1996–2015	2015 Year-End Total Housing Units*
Admiral	847	311	37%	1,131
Aurora-Licton Springs	2,534	977	39%	3,454
Columbia City	1,794	1,367	76%	2,683
Crown Hill	1,125	174	15%	1,307
Eastlake	2,632	821	31%	3,829
Green Lake	1,512	860	57%	2,605
Greenwood/Phinney Ridge	1,244	595	48%	1,757
Madison-Miller	1,639	1,159	71%	2,781
Morgan Junction	1,196	220	18%	1,342
North Beacon Hill	1,171	215	18%	1,474
Othello	1,715	1,563	91%	2,836
Rainier Beach	1,280	113	9%	1,520
Roosevelt	1,031	573	56%	1,616
South Park	975	195	20%	1,292
Upper Queen Anne	1,363	377	28%	1,724
Wallingford	2,158	951	44%	3,222
Westwood/Highland Park	1,790	281	16%	2,150
Manufacturing/Industrial Centers	1,298	-39	-3%	1,065
Ballard/Interbay/Northend	551	-15	-3%	660
Greater Duwamish	747	-24	-3%	405
Inside Centers/Villages	90,641	56,552	62%	147,001
Outside Villages	170,972	16,503	10%	189,187
City Total	261,613	73,055	28%	336,188

*To estimate the 2015 total number of housing units, City staff started with the most recent decennial Census (2010) housing unit count and added the net number new units built since that count was taken. (Net new units built is the number of newly built minus the number of units demolished, based on numbers in the SDCI permit system.) Adding the 1996–2015 permit data in the table to the 1995 total does not match the 2015 total, due to recalibrating the housing unit count from the 2010 decennial Census.

Growth Strategy Appendix Figure A-2

Total Covered Employment by Location in Seattle 1995–2014*

Location	1995	2000	2010	2014	Change 1995–2014	% Change 1995–2014
Belltown	17,382	23,526	17,988	18,647	1,265	7%
Denny Triangle	15,407	20,910	16,120	19,708	4,301	28%
Commercial Core	90,375	100,706	84,080	92,205	1,830	2%
Pioneer Square	10,887	16,424	10,454	11,807	920	8%
Chinatown/International District	4,099	4,858	7,739	8,327	4,228	103%
Capitol Hill	6,986	7,848	5,444	5,770	-1,216	-17%
Pike/Pine	3,581	6,325	5,033	6,404	2,823	79%
First Hill	18,194	19,197	26,106	21,540	3,346	18%
12th Avenue	3,577	4,486	5,054	5,333	1,756	49%
Northgate	9,432	11,006	11,430	12,288	2,856	30%
South Lake Union	15,166	22,735	19,644	35,859	20,693	136%
Uptown	16,377	16,161	13,911	14,592	-1,785	-11%
Ravenna	1,327	2,206	2,708	3,503	2,176	164%
University Campus	19,982	23,070	25,568	27,395	7,413	37%
University District Northwest	7,020	7,887	4,696	5,358	-1,662	-24%
Ballard	4,699	5,126	5,447	7,199	2,500	53%
Bitter Lake Village	3,145	4,315	3,100	3,549	404	13%
Fremont	4,862	5,745	7,468	8,489	3,627	75%
Lake City	1,688	1,831	1,600	1,323	-365	-22%
Mt. Baker (North Rainier)	4,995	5,357	3,614	4,254	-741	-15%
West Seattle Junction	2,504	2,825	2,695	3,334	830	33%
23rd & Union-Jackson	5,030	6,248	4,269	4,913	-117	-2%
Admiral	882	1,089	1,400	1,390	508	58%
Aurora-Licton Springs	2,734	2,857	2,334	2,218	-516	-19%

Location	1995	2000	2010	2014	Change 1995-2014	% Change 1995-2014
Columbia City	1,567	1,443	1,902	2,532	965	62%
Crown Hill	759	805	847	1,006	247	33%
Eastlake	4,444	6,036	5,065	5,159	715	16%
Green Lake	1,235	1,483	1,456	1,729	494	40%
Greenwood/Phinney Ridge	1,345	1,639	1,705	1,941	596	44%
Madison-Miller	831	841	1,065	1,353	522	79%
Morgan Junction	590	538	430	589	-1	63%
North Beacon Hill	359	527	559	588	229	0%
Othello	853	1,148	1,378	1,529	676	64%
Rainier Beach	924	1,118	1,088	1,066	142	107%
Roosevelt	1,378	1,951	1,496	1,661	283	15%
South Park	1,078	990	1,035	1,232	154	21%
Upper Queen Anne	918	1,389	1,556	1,899	981	14%
Wallingford	2,581	3,643	2,784	2,948	367	14%
Westwood/Highland Park	991	951	1,367	1,463	472	48%
Ballard/Interbay/Northend	14,726	15,162	14,205	16,308	1,582	11%
Greater Duwamish	57,666	67,803	58,744	62,571	4,905	9%
Outside Villages	64,148	72,629	77,591	83,732	19,584	31%
Totals	426,724	502,834	462,175	516,725	87,987	21%

*Covered employment includes employees who are covered by the Washington Unemployment Insurance Act. It excludes self-employed workers, proprietors, CEOs, and other non-insured workers. Typically, covered employment has represented 85-90 percent of total employment.

Land Use Appendix

Land Use Appendix Figure A-1

Existing Land Area Occupied by Specific Uses by Urban Centers and Urban Villages

Location	Green Acres	Rights-of-Way	Net Acres*	Single-Family	Multi-Family	Commercial/ Mixed-Use	Industrial	Major Institutions & Public Facilities/ Districts	Open Space**	Vacant	Other***
Downtown Urban Center	950	408	542	1	46	385	20	40	20	26	70
First Hill/Capitol Hill Urban Center	916	345	571	29	227	157	14	85	23	23	53
University Community Urban Center	752	190	562	22	115	120	8	278	8	6	20
Northgate	411	111	300	6	72	177	1	23	16	4	17
South Lake Union	339	145	194	0	8	127	25	7	14	13	19
Uptown	333	112	221	4	41	150	6	8	7	5	18
Urban Centers Total	3,701	1,312	2,389	62	509	1,116	73	442	88	76	197
Ballard	425	150	274	47	113	74	11	15	6	7	7
Bitter Lake Village	352	62	290	14	55	135	38	31	10	7	4
Fremont	213	81	133	14	41	47	18	5	4	4	2
Lake City	142	40	103	5	38	42	4	5	5	4	4
North Rainier	455	147	308	82	37	68	43	14	34	30	7
West Seattle Junction	226	88	138	38	34	47	2	10	1	7	4
Hub Urban Villages Total	1,814	568	1,246	199	318	413	115	80	59	59	27

Location	Gross Acres	Rights-of-Way	Net Acres*	Single-Family	Multifamily	Commercial/ Mixed-Use	Industrial	Major Institutions & Public Facilities/ Orphan	Open Space**	Vacant	Other***
23rd & Union-Jackson	516	167	350	129	81	39	8	40	32	21	7
Admiral	98	30	68	12	11	17		13	14		1
Aurora-Licton Springs	327	95	232	54	76	40	23	25	9	5	7
Columbia City	313	95	217	68	49	32	4	14	17	32	6
Crown Hill	173	50	123	75	18	22	1	4	2	1	1
Eastlake	200	91	109	13	48	36	2	2	5	3	1
Green Lake	109	49	60	11	25	12	0	9	2	0	1
Greenwood/Phinney Ridge	94	31	63	4	12	40	1	2	0	2	2
Othello	375	94	281	87	58	27	5	27	9	64	4
Madison-Miller	145	50	95	27	36	15	0	5	8	4	3
Morgan Junction	114	39	75	40	18	11	0	4	0	0	0
North Beacon Hill	131	51	80	35	25	9	0	4	3	3	0
Upper Queen Anne	53	21	32	1	13	13	0	4		0	0
Rainier Beach	290	70	219	48	43	34	4	44	16	30	2
Roosevelt	158	61	97	51	9	18	1	13	0	6	2
South Park	263	80	184	116	20	6	5	5	15	15	1
Wallingford	257	99	158	79	29	31	2	12	4	1	2
Westwood/Highland Park	275	81	194	99	40	37	2	11		6	1
Residential Urban Villages Total	3,891	1,254	2,638	949	611	440	58	240	139	193	40
Ballard/Interbay/ Northend	932	218	713	4	2	154	166	283	5	97	9
Greater Duwamish	4,928	1,126	3,802	13	4	283	1,457	1,493	30	502	82

Location	Gross Acres	Rights-of-Way	Net Acres*	Single-Family	Multifamily	Commercial/ Mixed-Use	Industrial	Major Institutions & Public Facilities/ Utilities	Open Space**	Vacant	Other***
Manufacturing Industrial Centers Total	5,859	1,344	4,515	17	6	436	1,624	1,776	35	599	91
Outside Villages	37,886	9,676	28,210	17,592	1,715	667	121	1,561	5,377	1,108	110
City Total	53,151	14,153	38,998	18,818	3,159	3,072	1,991	4,099	5,698	2,035	465

*Net acres = Gross acres minus rights-of-way

**Some acreage may be also counted in rights-of-way as City-owned open space including boulevards.

***Other includes parking, easements, unspecified uses.

Source: King County Department of Assessments, 2014

Land Use Appendix Figure A-2

Population and Housing Units per Acre by Urban Center and Urban Village

	Gross Acres	Total Population 2010	Population /Acre	Housing Units 2015	Housing Unit/Acre
Downtown Urban Center	950	26,844	28.3	24,347	25.6
First Hill/Capitol Hill Urban Center	916	35,892	39.2	29,619	32.3
University District Urban Center	752	22,704	30.2	9,802	13.0
Northgate	411	6,369	15.5	4,535	11.0
South Lake Union	339	3,774	11.1	4,536	13.4
Uptown	333	7,300	21.9	7,483	22.5
Urban Centers Total	3,701	102,883	27.8	80,322	21.7
Ballard	425	10,078	23.7	9,168	21.6
Bitter Lake Village	352	4,273	12.1	3,257	9.3
Fremont	213	3,960	18.6	3,200	15.0
Lake City	142	3,899	27.5	2,546	17.9
Mt. Baker	455	4,908	10.8	2,454	5.4
West Seattle Junction	226	3,788	16.8	3,880	17.2
Hub Urban Villages Total	1,813	30,906	17.0	24,505	13.5

	Gross Acres	Total Population 2010	Population /Acre	Housing Units 2015	Housing Unit/Acre
23rd & Union-Jackson	516	9,468	18.3	5,451	10.6
Admiral	98	1,528	15.6	1,131	11.5
Aurora-Licton Springs	327	6,179	18.9	3,454	10.6
Columbia City	313	3,937	12.6	2,683	8.6
Crown Hill	173	2,459	14.2	1,307	7.6
Eastlake	200	5,084	25.4	3,829	19.1
Green Lake	109	2,904	26.6	2,605	23.9
Greenwood/Phinney Ridge	94	2,927	31.1	1,757	18.7
Othello	375	7,267	19.4	2,836	7.6
Madison-Miller	145	4,066	28.0	2,781	19.2
Morgan Junction	114	2,046	17.9	1,342	11.8
North Beacon Hill	131	2,900	22.1	1,474	11.3
Upper Queen Anne	53	2,143	40.4	1,724	32.5
Rainier Beach	290	3,583	12.4	1,520	5.2
Roosevelt	158	2,384	15.1	1,616	10.2
South Park	263	3,448	13.1	1,292	4.9
Wallingford	257	5,350	20.8	3,222	12.5
Westwood/Highland Park	275	4,606	16.7	2,150	7.8
Residential Urban Villages Total	3,891	72,279	18.6	42,174	10.8
Ballard/Interbay/Northend	932	1,658	1.8	660	0.7
Greater Duwamish	4,928	1,064	0.2	405	0.1
Manufacturing Industrial Centers	5,860	2,722	0.5	1,065	0.2
Outside Villages	37,886	399,870	10.6	188,122	5.0
City Total	53,151	608,660	11.5	336,188	6.3

Total housing units is determined by adding net new built units (new-demo) from the SDCI permit system from 4/1/2010 to 12/31/2015 to the total housing units determined by Census 2010.

Land Use Appendix Figure A-3

Jobs per Acre by Urban Center and Urban Village

	Gross Acres	Total Population 2010	Population /Acre	Jobs 2014	Jobs/Acre
Downtown Urban Center	950	26,844	28.3	150,694	158.6
First Hill/Capitol Hill Urban Center	916	35,892	39.2	39,047	42.6
University District Urban Center	752	22,704	30.2	36,256	48.2
Northgate	411	6,369	15.5	12,288	29.9
South Lake Union	339	3,774	11.1	35,859	105.8
Uptown	333	7,300	21.9	14,592	43.8
Urban Centers Total	3,701	102,883	27.8	288,736	78.0
Ballard	425	10,078	23.7	7,199	16.9
Bitter Lake Village	352	4,273	12.1	3,549	10.1
Fremont	213	3,960	18.6	8,489	39.9
Lake City	142	3,899	27.5	1,323	9.3
Mt. Baker	455	4,908	10.8	4,254	9.3
West Seattle Junction	226	3,788	16.8	3,334	14.8
Hub Urban Villages Total	1,813	30,906	17.0	28,148	15.5
23rd & Union-Jackson	516	9,468	18.3	4,913	9.5
Admiral	98	1,528	15.6	1,390	14.2
Aurora-Licton Springs	327	6,179	18.9	2,218	6.8
Columbia City	313	3,937	12.6	2,532	8.1
Crown Hill	173	2,459	14.2	1,006	5.8
Eastlake	200	5,084	25.4	5,159	25.8
Green Lake	109	2,904	26.6	1,729	15.9
Greenwood/Phinney Ridge	94	2,927	31.1	1,941	20.6
Othello	375	7,267	19.4	1,529	4.1
Madison-Miller	145	4,066	28.0	1,353	9.3
Morgan Junction	114	2,046	17.9	589	5.2

	Gross Acres	Total Population 2010	Population /Acre	Jobs 2014	Jobs/Acre
North Beacon Hill	131	2,900	22.1	588	4.5
Upper Queen Anne	53	2,143	40.4	1,899	35.8
Rainier Beach	290	3,583	12.4	1,066	3.7
Roosevelt	158	2,384	15.1	1,661	10.5
South Park	263	3,448	13.1	1,232	4.7
Wallingford	257	5,350	20.8	2,948	11.5
Westwood/Highland Park	275	4,606	16.7	1,463	5.3
Residential Urban Villages Total	3,891	72,279	18.6	35,216	9.1
Ballard/Interbay/Northend	932	1,658	1.8	16,308	17.5
Greater Duwamish	4,928	1,064	0.2	62,571	12.7
Manufacturing Industrial Centers	5,860	2,722	0.5	78,879	13.5
Outside Villages	37,886	399,870	10.6	83,732	2.2
City Total	53,151	608,660	11.5	514,711	9.7

Covered employment estimates are based on the Washington State Employment Security Department's (ESD) Quarterly Census of Employment and Wages (QCEW) series. This series consists of employment for those firms, organizations, and individuals whose employees are covered by the Washington Unemployment Insurance Act. Covered employment excludes self-employed workers, proprietors, CEOs, etc., and other noninsured workers. Typically, covered employment has represented 90–93 percent of total employment. Note that this includes part-time and temporary employment, and if a worker holds more than one job, each job would appear in the database.

Land Use Appendix Figure A-4

Employment by Industry Sector 1995–2014

Industry Sector*	1995 Jobs	% Share	2010 Jobs	% Share	2014 Jobs	% Share	2014 Jobs	% Share	Sector % Change 1995–2014
Construction, Resources	15,282	3.6%	22,645	4.5%	16,748	3.6%	18,200	3.5%	-24.4%
Finance, Insurance, Real Estate	35,253	8.3%	42,471	8.4%	31,970	6.9%	31,781	6.2%	-33.6%
Manufacturing	38,050	8.9%	37,104	7.4%	26,417	5.7%	26,400	5.1%	-40.5%

Industry Sector*	1995 Jobs**	% Share	2010 Jobs	% Share	2014 Jobs	% Share	2014 Jobs	% Share	Sector % Change 2010-2014
Retail	31,504	7.4%	41,984	8.3%	36,921	8.0%	51,345	10.0%	18.2%
Services	185,899	43.6%	235,336	46.8%	237,882	51.5%	273,336	53.1%	13.9%
Warehousing, Transportation, Utilities	40,545	9.5%	43,636	8.7%	29,206	6.3%	30,213	5.9%	-44.4%
Government	51,571	12.1%	47,565	9.5%	48,468	10.5%	46,470	9.0%	-2.4%
Education	28,625	6.7%	32,094	6.4%	34,570	7.5%	36,965	7.2%	13.2%
Total	426,729	100%	502,835	100%	462,180	100%	514,710	100%	2.3%

The total number of covered employment jobs increased by 17 percent from 1995 to 2014, from 426,729 to 514,710. From year 2000 to year 2014, the total number of covered jobs increased by 2.3 percent, from 502,835 to 514,710.

*The method of identifying jobs by sector has changed since 1995, and it is not practical to compare employment by sector between 1995 and later years.

**Jobs are a report of “covered employment,” which refers to positions covered by the Washington Unemployment Insurance Act. The act exempts the self-employed, proprietors and corporate officers, military personnel, and railroad workers, so those categories are not included in the dataset. Covered employment accounts for approximately 90 percent of all employment.

Source: Washington State Employment Security Department Quarterly Census of Employment and Wages and Puget Sound Regional Council. March, 1995, 2010, and 2014

Land Use Appendix Figure A-5

Proportions of Employment by Sector, 2000–2035

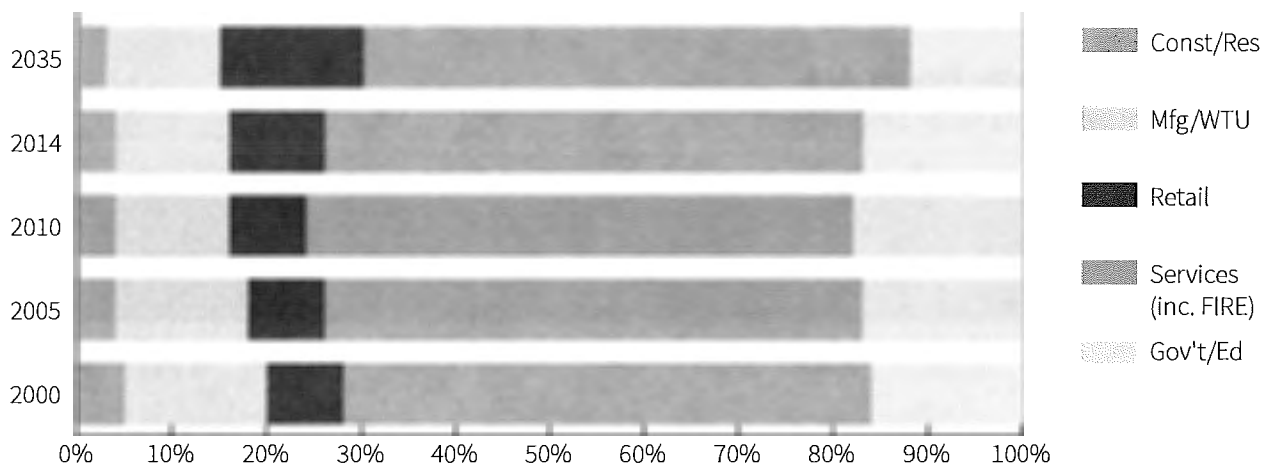

Source: Puget Sound Regional Council Vision 2040 Regional Growth Strategy/Land Use Vision dataset and covered employment estimates

Land Use Appendix Figure A-6

Population Density 2010

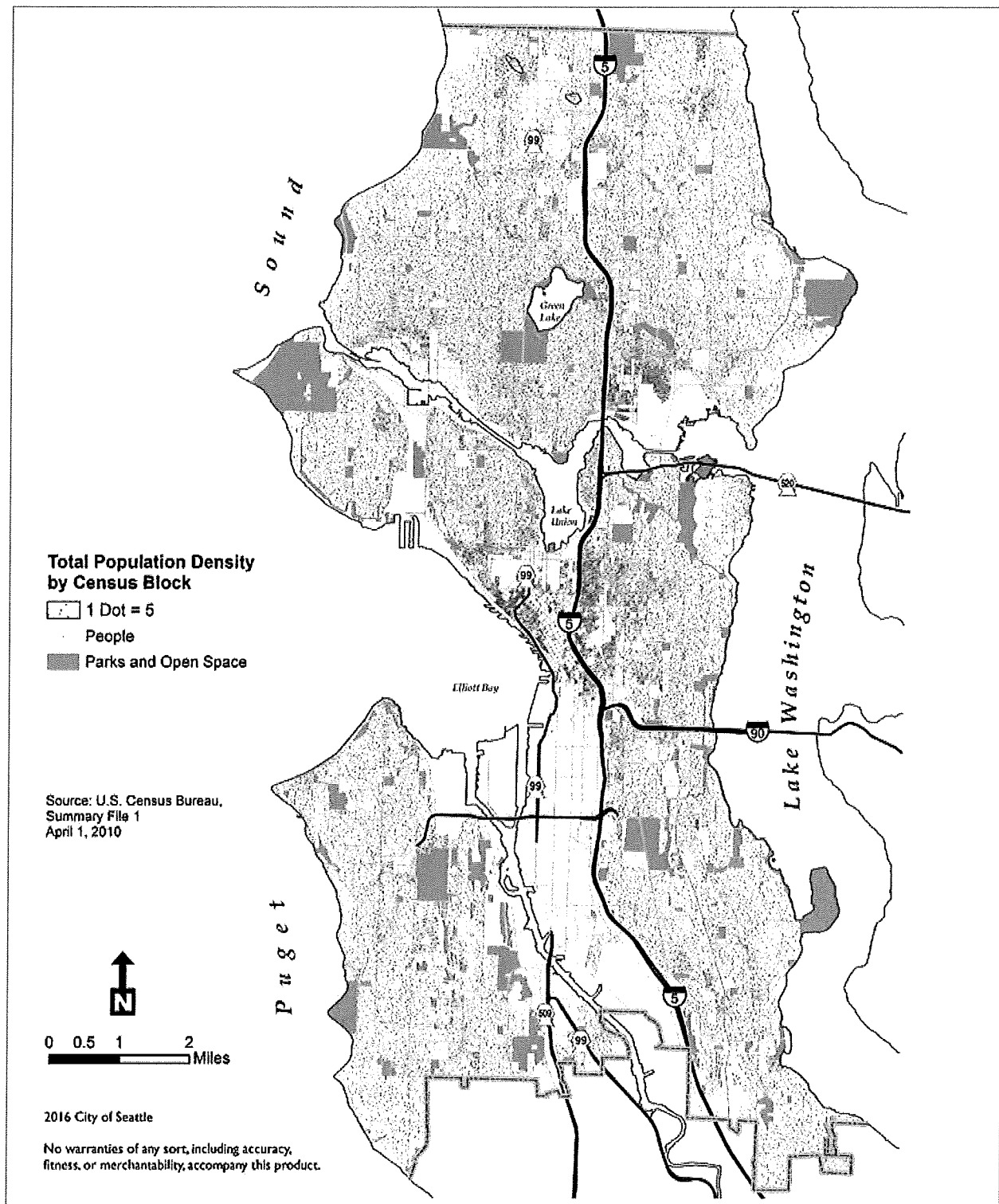

Land Use Appendix Figure A-7

Household Density 2010

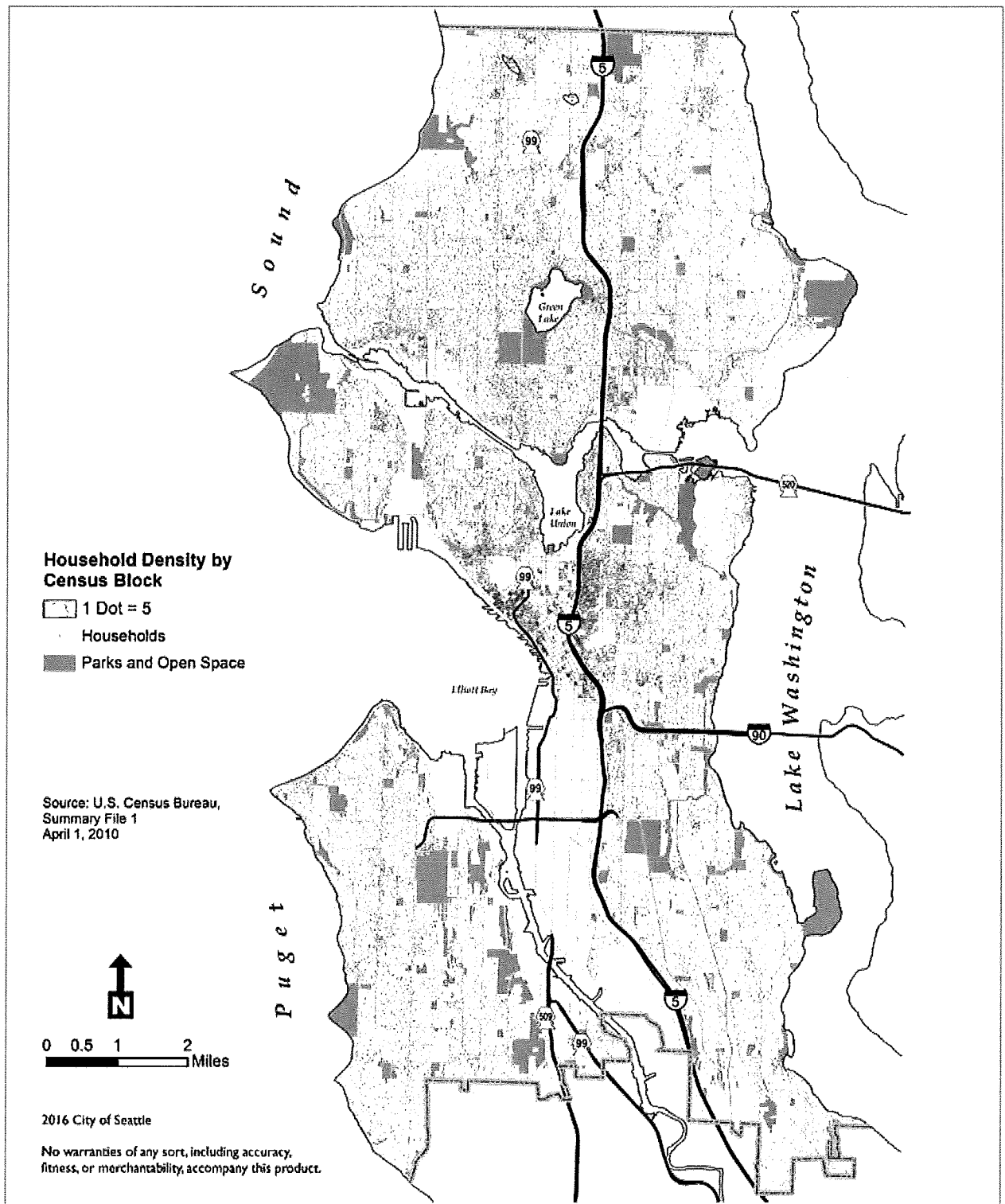

Land Use Appendix Figure A-8

Employment Density 2010

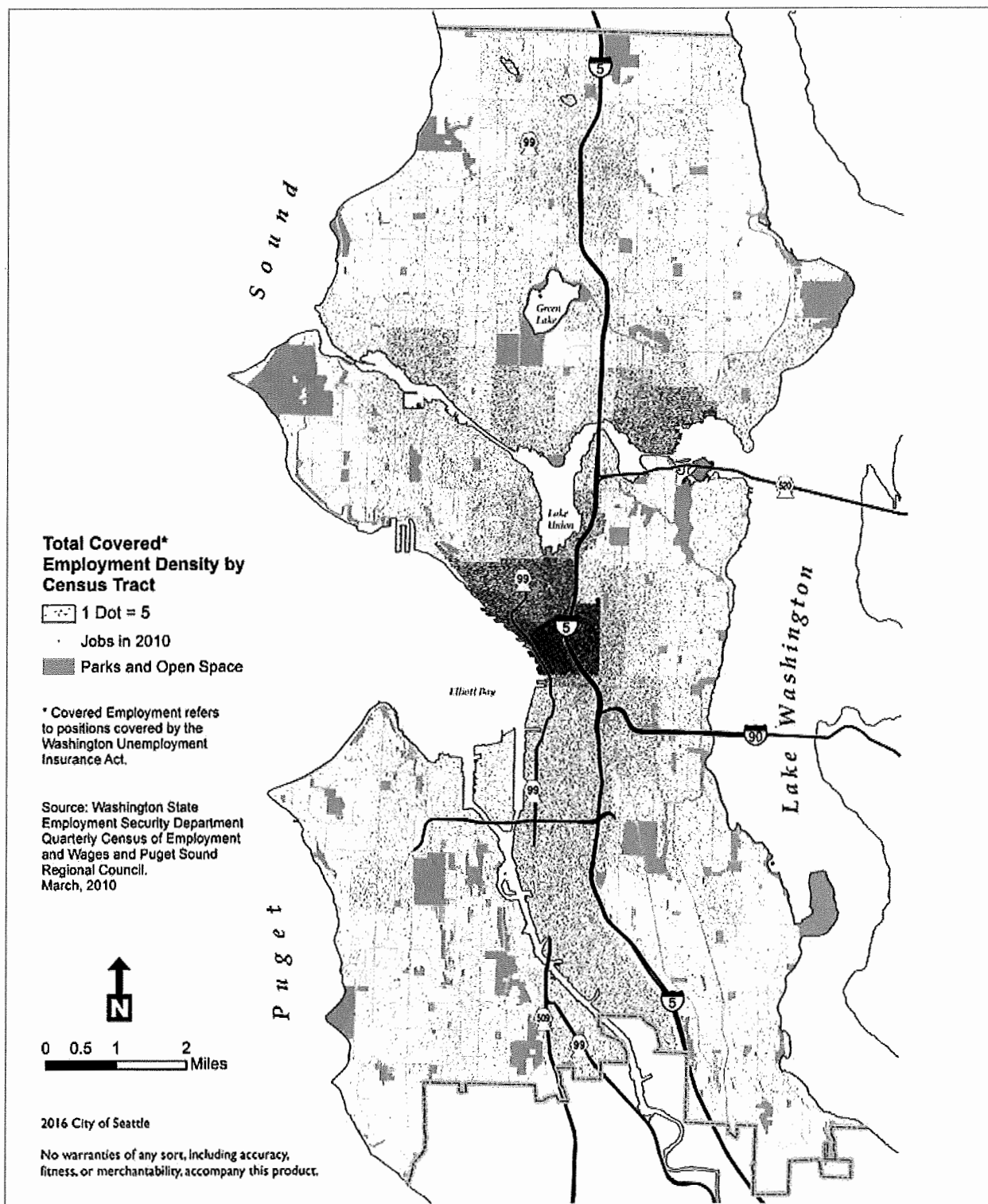

Land Use Appendix Figure A-9

Generalized* Existing Land Use

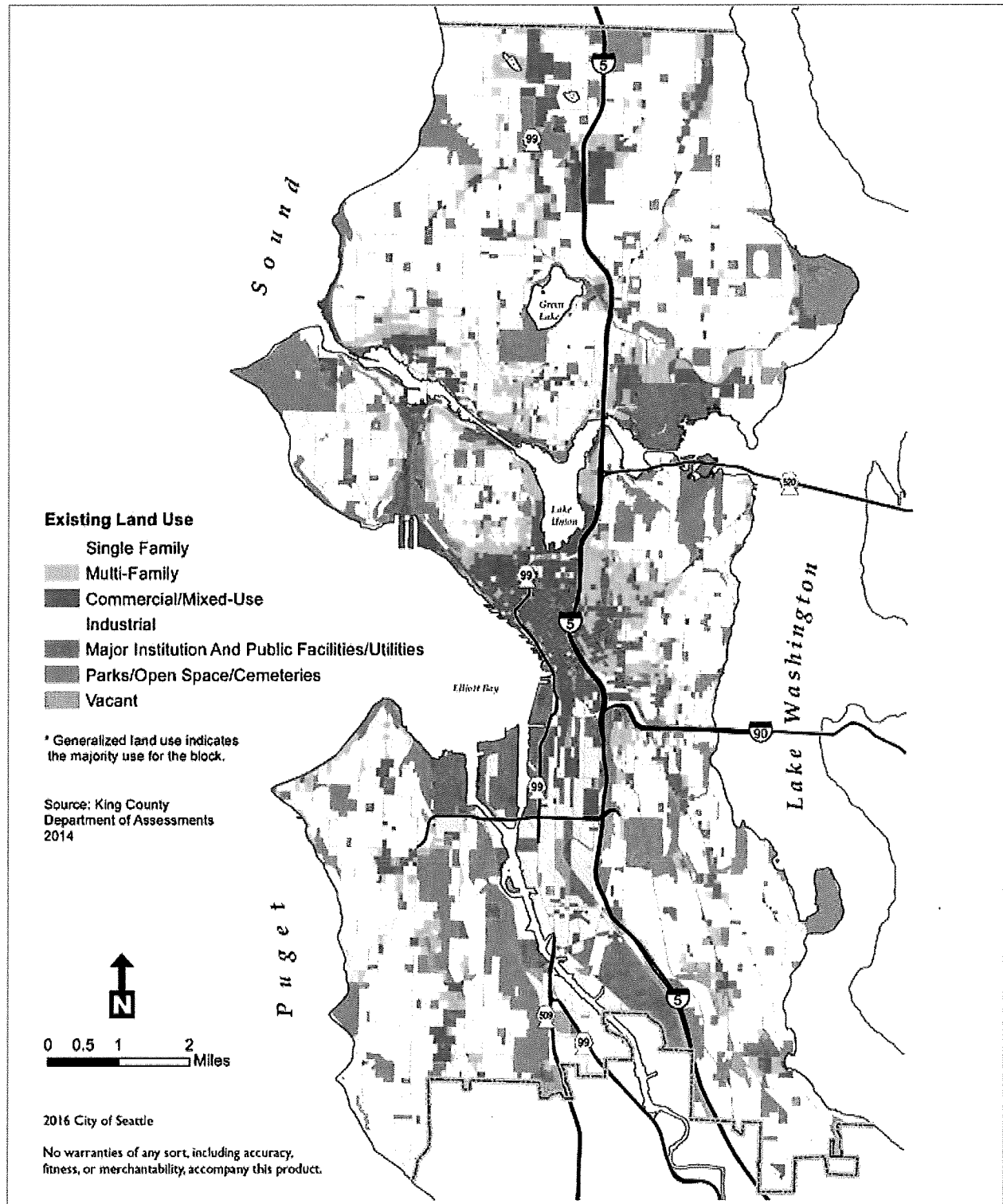



Transportation Appendix

Introduction

Many of the terms used in the Transportation element and appendix may be unfamiliar to the casual reader. The purpose of providing the information in this appendix, and related information in the Transportation element, is to comply with the requirements of the state Growth Management Act (GMA), RCW Chapter 36.70A, by showing land use assumptions used in estimating travel; estimated traffic impacts to state-owned transportation facilities based on those assumptions; facilities and service needs, including level of service standards for local arterials and state highways; forecasts of traffic; and a financing plan to show how these needs will be met.

There are useful glossaries in the State of Washington Department of Commerce's Transportation Guidebook (<http://www.commerce.wa.gov/Services/localgovernment/GrowthManagement/Growth-Management-Planning-Topics/Pages/Transportation.aspx>), Washington State Department of Transportation's (WSDOT) website titled Growth Management Act (GMA); <http://www.wsdot.wa.gov/Publications/Manuals/index.htm> and at Comprehensive Plan Resources (<http://www.wsdot.wa.gov/planning/community/GMA>).

Land Use Assumptions Used in Estimating Travel

To estimate future travel levels, assumptions were made for a variety of factors related to future population, employment, and transportation facilities. These include the number and geographic distribution of both households and employment in Seattle and the region, characteristics of households and jobs (e.g., number of residents per household, household income), and the transportation network (e.g., streets, transit routes). Then, a computer model was used to predict the total number of person-trips between various travel zones, the number of trips that would use various modes (e.g., car, bus, bike, walk), and the resulting vehicle traffic volumes on various streets throughout the city.

Existing Conditions

In 2010, the Census counted 608,660 people living in Seattle and 308,500 housing units. The State Office of Financial Management (OFM) provided an estimate in April 2015 of approximately 662,400 residents, 314,326 households, and 332,694 housing units. Many people visit Seattle for various purposes, such as working, shopping, education, tourism, medical appointments, pass-through travel, and other reasons.

Regional Land Use Assumptions

The Puget Sound Regional Council (PSRC) conducts regional planning for the four-county (Snohomish, King, Pierce, and Kitsap) central Puget Sound region. The PSRC's Vision 2040 and Transportation 2040 present a vision of growth management and an array of transportation policies to guide transportation investment decisions. The PSRC provides population and employment forecasts for the region, and encourages growth in ways that focus future population and employment growth into urban centers, including those urban centers defined in this Comprehensive Plan.

Seattle Land Use Assumptions

Seattle's growth assumptions for the period from 2015 through 2035 are 70,000 net new housing units and 115,000 net new jobs. This is Seattle's share of the region's projected housing and employment growth between 2015 and 2035, allocated through the county-wide planning process conducted by the Growth Management Planning Council.

The growth assumptions for the urban centers are as follows:

Urban Center	Housing Units	Jobs
Downtown	12,000	35,000
First Hill/Capitol Hill	6,000	3,000
South Lake Union	7,500	15,000
Uptown	2,000	2,000
University District	3,500	5,000
Northgate	3,000	8,000
Greater Duwamish Mfg./Industrial Center	NA	6,000
BINMIC	NA	3,000

Expected growth in urban villages is shown in the following table.

	Expected Housing Growth Rate*	Expected Job Growth Rate*
Hub Urban Villages	40%	50%
With very good transit service	60%	50%
With high displacement risk and low access to opportunity, regardless of the level of transit service	40%	50%
Residential Urban Villages	30%	
With very good transit service	50%	
With high displacement risk and low access to opportunity, regardless of the level of transit service	30%	

*Percentage growth above the actual number of housing units or jobs in 2015, except where limited by zoning capacity.

Facilities and Service Needs

Seattle’s street network consists of approximately 1,534 miles of arterials, including some that are designated state routes, and more than 2,400 miles of non-arterials (**see *Transportation Appendix Figure A-1***). In the arterial system there are 620 miles of principal arterials, 566 miles of minor arterials, and 348 miles of collector arterials. High-occupancy vehicle (HOV) lanes exist on some arterials and limited access facilities as shown in Transportation Appendix Figure A-2.

Transit

Public transit in Seattle is provided by three agencies. King County Metro provides bus, trolley, and streetcar services that cover most of King County. Community Transit and Sound Transit operate express bus services to Seattle from King, Snohomish, and Pierce Counties. As of 2014, King County Metro serves a population of more than two million people in a service area greater than 2,000 square miles. It operates more than 1,800 vehicles on about 214 bus, trolley, and dial-a-ride routes. Included are 159 electric trolley buses serving fourteen routes along almost seventy miles of two-direction overhead wires. Its 2012 ridership was more than 114 million passengers. Transportation Appendix Figure A-3 shows bus routes in Seattle.

King County Metro operates a 1.3-mile-long tunnel under Third Avenue and Pine Street from the International District to Ninth Avenue and Pine Street. The tunnel has four operational stations, and connects to I-90 at the south end and to the I-5 express lanes at the north end.

The tunnel supports joint bus and light rail service until such time as light rail train service is too frequent to safely operate joint services in the tunnel.

Sound Transit is the regional transit authority for the Puget Sound area (which includes portions of King, Snohomish, and Pierce Counties.) Sound Transit operates light rail service connecting Downtown Seattle with SeaTac Airport and has construction under way to extend service northward to Lynnwood. Stations serving Capitol Hill and Husky Stadium opened in March 2016. Light rail will serve additional stations in the University District, Roosevelt, and Northgate by 2021. Routing is shown on Transportation Appendix Figure A-4.

There are thirteen Link light rail stations currently in Seattle: in Rainier Beach, Othello, Columbia City, North Rainier/Mt. Baker, Beacon Hill, SODO/Lander Street, and SODO/Royal Brougham Way, Capitol Hill, Husky Stadium, and four in the Downtown transit tunnel. Weekday ridership averaged more than 37,000 passengers in 2014.

Sound Transit also provides Sounder commuter rail services during peak hours along existing rail lines from Downtown Seattle northward to Everett and southward to Tacoma and Lakewood. Metro, Sound Transit, and WSDOT operate approximately eighteen park-and-ride facilities with approximately 2,262 parking spaces in Seattle. **(See Transportation Appendix Figure A-5.)**

Transportation Appendix Figure A-1

Arterial Classification

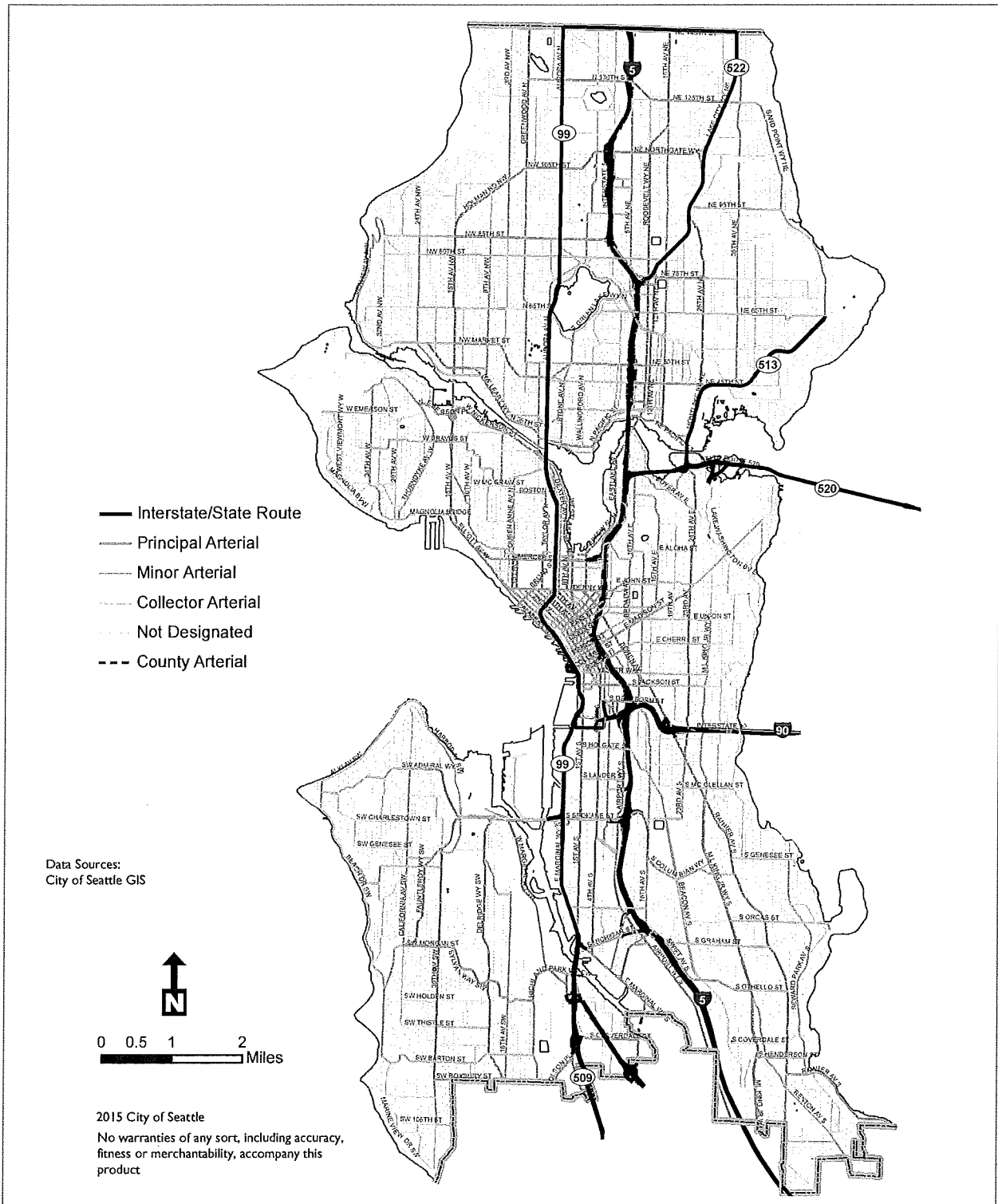

Transportation Appendix Figure A-2

Transit/High-Occupancy Vehicle Lanes

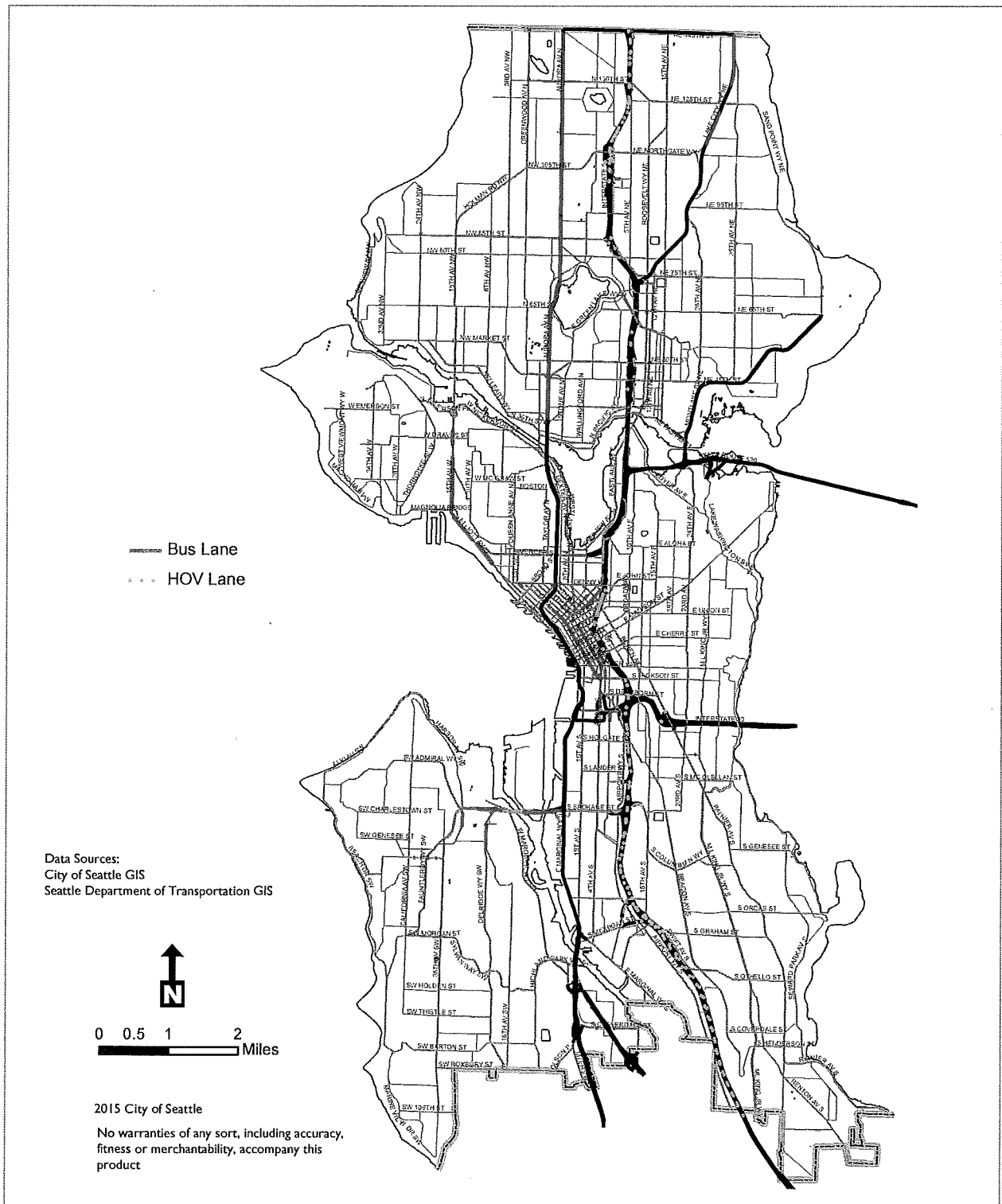

Transportation Appendix Figure A-3

Bus Routes

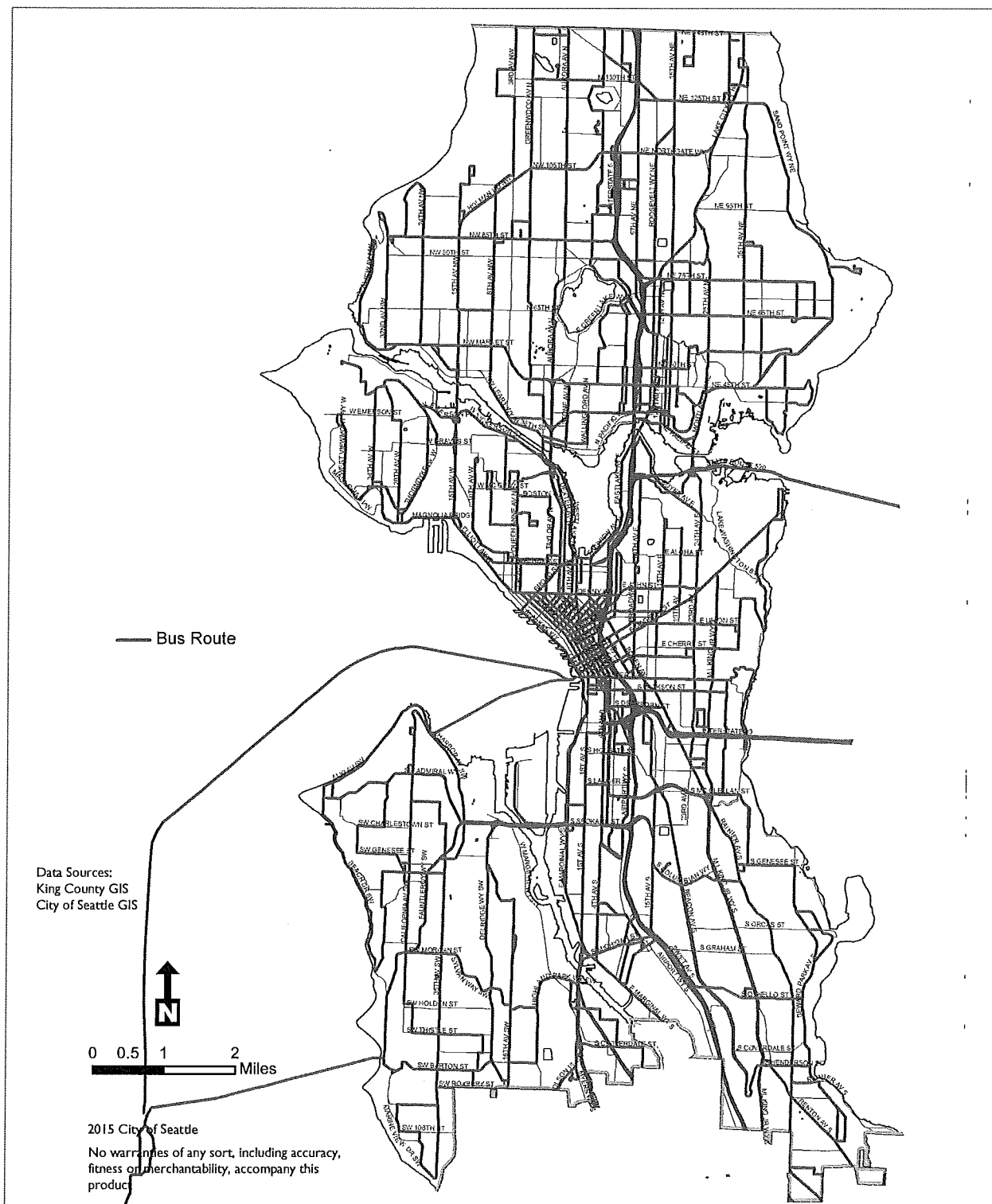

Transportation Appendix Figure A-4

Rail & Ferry Routes

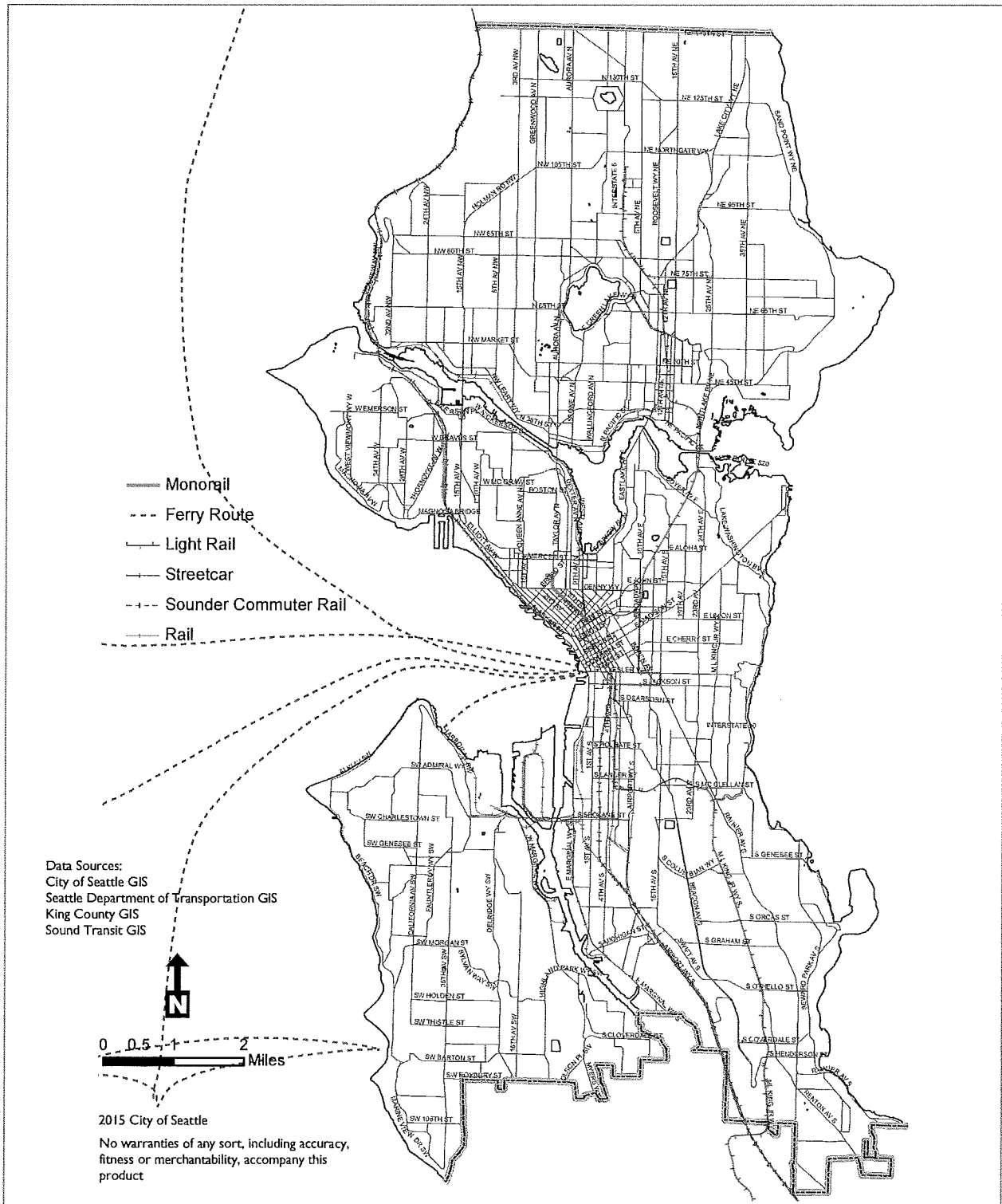

Transportation Appendix Figure A-5

Park & Ride Facilities

Lot	Name	Address	Spaces	Amenities/Routes/Notes
N/A	Montlake Station	Montlake Blvd E & SR 520	0	54 Bike Lockers Metro: 25, 43, 48 22 Bike Lockers Metro: 48, 64, 66, 67, 76, 242, 316
703	Green Lake Park & Ride	6601 8th Ave NE	411	Sound Transit: 542 *Lot is usually filled 90 percent or above by 9:00 a.m. on weekdays
505	Lamb of God Lutheran Church	12509 27th Ave NE	21	Metro: 41
706	North Seattle Interim Park & Ride	402 NE 103rd Street	156	Metro: 16, 40, 41, 66, 67, 68, 75, 242, 303, 345, 346, 347, 348, 995 Sound Transit: 555, 556 Spaces located on floors 1 and 2
758	Northgate Mall Park & Ride Garage	NE 103rd St & 1st Ave NE	280	Metro: 16, 40, 41, 66, 67, 68, 75, 242, 303, 345, 346, 347, 348, 995 Sound Transit: 555, 556 *Lot is usually filled 90 percent or above by 9:00 a.m. on weekdays. 12 Bike Lockers 12 On-Demand Bike eLockers Ticket Vending Machines
753	Northgate Transit Center	10200 1st Ave NE	296	Metro: 16, 40, 41, 66, 67, 68, 75, 242, 303, 345, 346, 347, 348, 995 Sound Transit: 555, 556 Boarding Locations Map *Lot is usually filled 90 percent or above by 9:00 a.m. on weekdays.

Lot	Name	Address	Spaces	Amenities/Routes/Notes
				Spaces include 50 for carpool
753.1 and 753.2	Northgate Transit Center East Park & Ride	3rd Ave NE & NE 103rd St	448	Metro: 16, 40, 41, 66, 67, 68, 75, 242, 303, 345, 346, 347, 348, 995 Sound Transit: 555, 556 *Lot is usually filled 90 percent or above by 9:00 a.m. on weekdays.
710	South Jackson Park Park & Ride	5th Ave NE & NE 133rd St	46	Metro: 242 Garage Floors P1 & P2 Hours: Monday-Friday 6 a.m. - 8 p.m.
760	Thornton Place Garage	3rd Ave NE & NE 100th St	350	Metro: 16, 40, 41, 66, 67, 68, 75, 242, 303, 345, 346, 347, 348, 995 Sound Transit: 555, 556 *Lot is usually filled 90 percent or above by 9:00 a.m. on weekdays.
749	Airport & Spokane Park & Ride	Airport Way S & S Spokane St	25	Metro: 101, 102, 106, 131, 150, 177, 178, 190 Sound Transit: 590, 592, 593, 594, 595
550	Beverly Park First Baptist Church	11659 1st Ave S	12	Metro: 128, 131 37 Bike Lockers No Metro or Sound Transit Parking Available
N/A	Columbia City Station	4818 Martin Luther King Jr. Way S	0	Paid Parking Nearby Ticket Vending Machines Sound Transit: Central Link Light Rail Closest Bus Route: Metro: 8
591	Community Bible Fellowship	11227 Renton Ave S	29	Metro: 106
562	Holy Family Church	9641 20th Ave SW	23	Metro: 22, 113, 125 Sound Transit: 560
738	Olson Place & Myers Way Park & Ride	9000 Olson Pl SW	100	Metro: 60, 113

Lot	Name	Address	Spaces	Amenities/Routes/Notes
N/A	SODO Station	500 S Lander St	0	16 Bike Lockers Sound Transit: Central Link Light Rail
553	Sonrise Evangelical Free Church	610 SW Roxbury St	10	Metro: 60, 113
744	Southwest Spokane St Park & Ride	3599 26th Avenue SW	55	Metro: 21, 37 Express

Source: King County Metro. "Park and Ride Information." Last modified 2014. <http://metro.kingcounty.gov/tops/parknride/>

Bicycles

Bicycles are classified as "vehicles" in the Seattle Traffic Code and have the right to use all streets in the city except where explicitly prohibited. Bicycling is growing in popularity as an everyday commuting method and as recreational activity. Transportation Appendix Figure A-6 illustrates the location of seven categories of bike facilities.

As of 2014, Seattle has 135 miles of bicycle facilities, including neighborhood greenways, protected bike lanes, in-street separations, sharrows, climbing lanes, and multi-use trails. The 2015 updates to the Bicycle Master Plan commit to further expanding the network to increase connectivity, completeness, and safety.

Bicycle racks are provided in neighborhood commercial areas and Downtown and other appropriate locations, and some workplaces provide secure, weather-protected bike parking, showers, and lockers. As of 2010, the City had installed over 2,550 bike racks across the city. Seattle's Land Use Code also requires that many new developments include bike parking to complement parking built for cars.

Pedestrians

As of 2010, Seattle had more than 2,200 miles of sidewalks, nearly 6,000 crosswalks, almost 27,000 curb ramps, 500 stairways, and thirty-nine lane miles of twelve-foot wide trails (**see pedestrian facilities mapped in Transportation Appendix Figure A-7**). Over the past decade, the City has made progress in addressing gaps in sidewalk coverage by pursuing construction of sidewalks or asphalt walkways in numerous locations where they were lacking, within the constraints of budgeted funding. Between 2009 and 2014, approximately 180 blocks of new sidewalk have been built citywide.

There remain several areas around the city, such as residential neighborhoods north of North 85th Street, that lack sidewalks because they were originally developed when

sidewalks were not required. The City has levy funding to build approximately 250 blocks of sidewalk over the next nine years.

Parking

On-street parking occurs in the public right-of-way and is therefore regulated by the City through the creation of no-parking and special-use parking zones, time-of-day restrictions, parking duration limits, pay stations/meters, and restricted parking zones (RPZs). Over the past decade, the City has modernized its pay stations/meters and continues to do so with innovations such as pay-by-phone. It also has pursued more active management of on-street parking rates in order to accomplish goals for availability of on-street parking for motorists wishing to park. This makes it easier for people to find parking when and where they need it.

RPZs are designed to protect Seattle's residential neighborhoods from parking impacts and congestion from major employment and/or retail centers. In an RPZ, on-street parking is generally restricted to one or two hours, except for residents and guests who display special RPZ decals. Existing RPZs include the following communities: Montlake, Squire Park, West Seattle-Fauntleroy, Capitol Hill, Wallingford, University District, First Hill, Eastlake, Magnolia, North Queen Anne, North Capitol Hill, Uptown (Seattle Center), Central District (Garfield High School), Belmont/ Harvard, Mount Baker (Franklin High School), North Beacon Hill, Licton Springs (North Seattle Community College), Cowen Park/Roosevelt, and Ravenna Bryant. The RPZ program is under review in 2016, with the objective to identify refinements that will respond to current needs and priorities with respect to neighborhoods' on-street parking.

Off-street parking facilities are usually privately owned and operated. The City regulates the location and size of garages and lots through the Land Use Code. Facilities with paid parking pay a licensing fee.

Carpools receive preferential parking treatment through City programs, allocation of on-street parking spaces, and Land Use Code requirements for carpool parking in new developments.

Rail

Passenger Rail: Amtrak operates trains over 900 miles of Burlington Northern tracks in the state and provides service to sixteen cities. The Empire Builder provides daily service from Seattle to Spokane and on to Chicago; the Amtrak Cascades runs four times a day to/from Portland, and twice daily to/from Vancouver, B.C. The Coast Starlight runs daily connecting Seattle to Portland, Oakland, and on to Los Angeles. Sound Transit operates two Sounder train routes on the same tracks between Seattle/Tacoma-Lakewood and Seattle/Everett.

Freight: Transportation Appendix Figure A-17 shows a map of Freight Assets located in Seattle. Among these, Burlington Northern Santa Fe (BNSF) owns and operates a mainline

dual-track from Portland to Seattle. Union Pacific owns and operates a single mainline track with two-way train operations between Tacoma and Seattle. BNSF owns and operates tracks that extend north from Downtown Seattle to Snohomish County and then east to Spokane.

There are four intermodal terminals servicing the Duwamish Industrial area: BNSF Railway operates the Seattle International Gateway yard north of South Hanford Street. Union Pacific Railroad operates the Seattle Argo Yard just south of Spokane Street off Diagonal/Denver Avenues in the Duwamish Manufacturing/Industrial Center. Port of Seattle terminals include intermodal facilities at Terminals 5 and 18. BNSF's Interbay rail yard is north of Downtown Seattle. The Ballard Terminal is a shortline operator that connects from the BNSF railway bridge crossing of the ship canal with a three-mile spur that runs along Shilshole Way. This is an important rail operation for local freight.

Rail-line capacity depends on train length, operating speeds, the number of switch cross-over points, and whether the line has one- or two-way traffic. Current train speed limits in the City are ten, twenty, or forty mph depending on the segment.

Port of Seattle and other intermodal facilities

The Port of Seattle owns, operates, or supports marine, rail, and air intermodal facilities. Port of Seattle facilities include nine commercial marine terminals, four ocean container terminals with thirty-one container cranes, and a deep-draft grain terminal. Steamship operators have direct service to Asia, Europe, Latin America, and domestic markets (Alaska and Hawaii).

Services are offered by seventeen ocean carriers, about thirty tug and barge operators, and BNSF Railway and Union Pacific railroads, operating intermodal yards. Transportation Appendix Figure A-8 shows Port of Seattle facilities located in Seattle.

Air Transportation

There are five commercial aircraft landing facilities in the greater Seattle metropolitan area: Seattle-Tacoma International Airport (Sea-Tac), operated by the Port of Seattle and located in the City of SeaTac; King County International Airport, located partly in Seattle; the Kenmore Air Harbor and Seattle Seaplanes facilities based in Seattle's Lake Union; and the Lake Washington sea-plane base near Kenmore. Transportation Appendix Figure A-9 shows air facilities in Seattle.

Water Transportation

The Washington State Ferry (WSF) system operates two terminals in Seattle: Colman Dock in Downtown Seattle, and the Fauntleroy terminal in West Seattle. Passenger-and-vehicle service is provided on two ferry routes from Colman Dock to Bainbridge Island and to Bremerton. Passenger-and-vehicle ferries link Fauntleroy with Vashon Island and Southworth. King County operates the Water Taxi service in Elliott Bay that connects to West Seattle.

Transportation Appendix Figure A-6

Bicycle Facilities

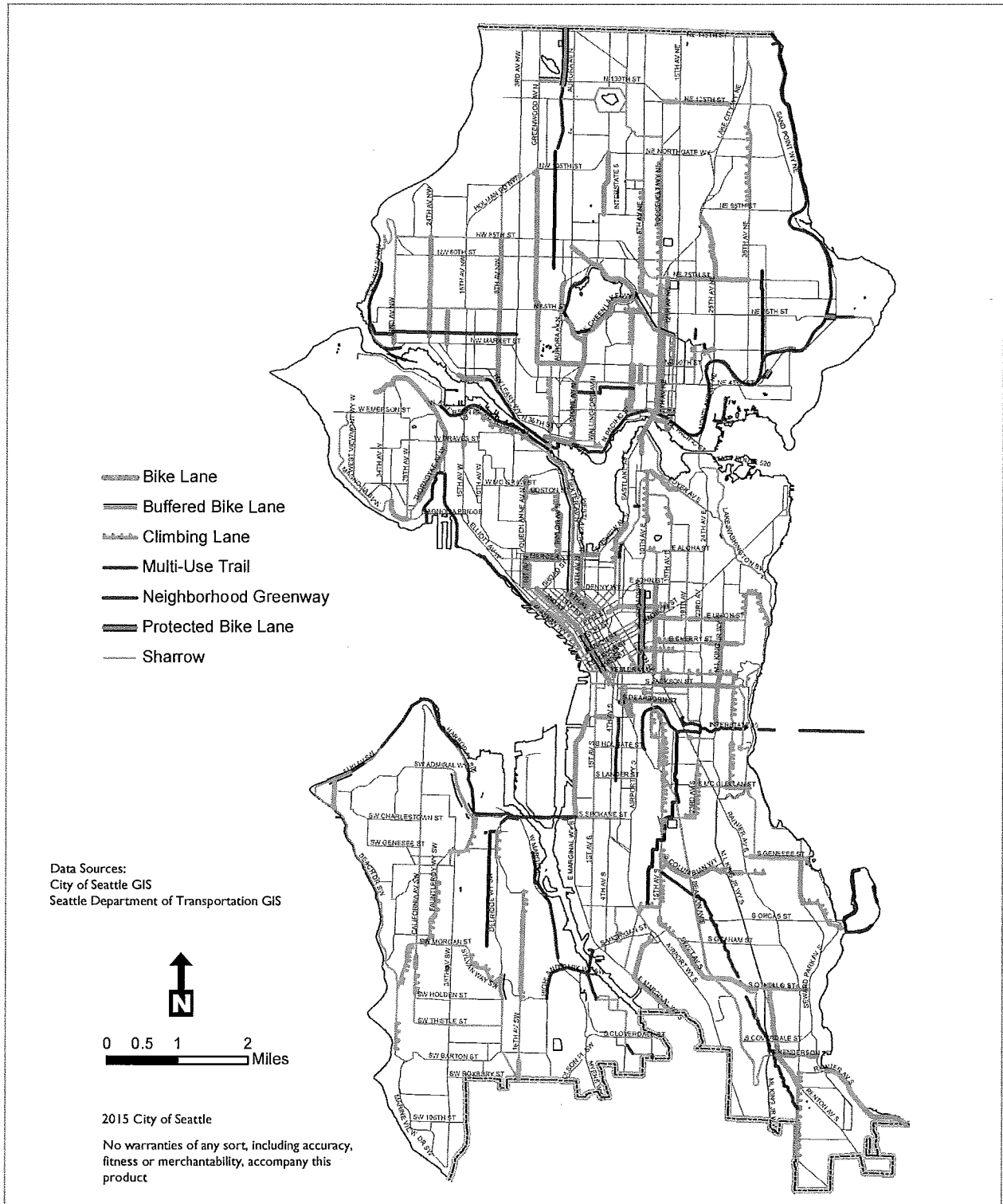

Transportation Appendix Figure A-7

Pedestrian Facilities

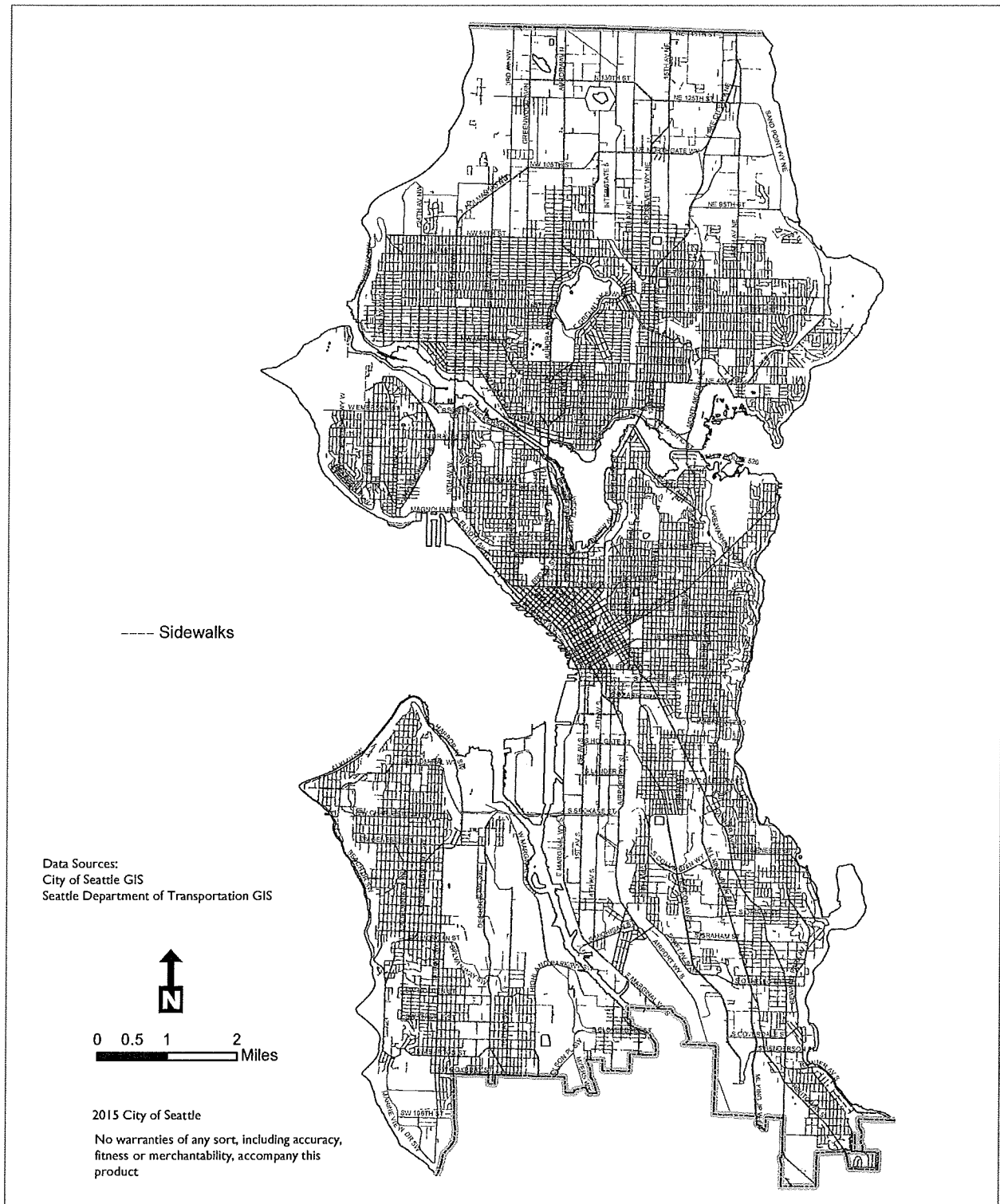

Transportation Appendix Figure A-8

Port of Seattle Facilities

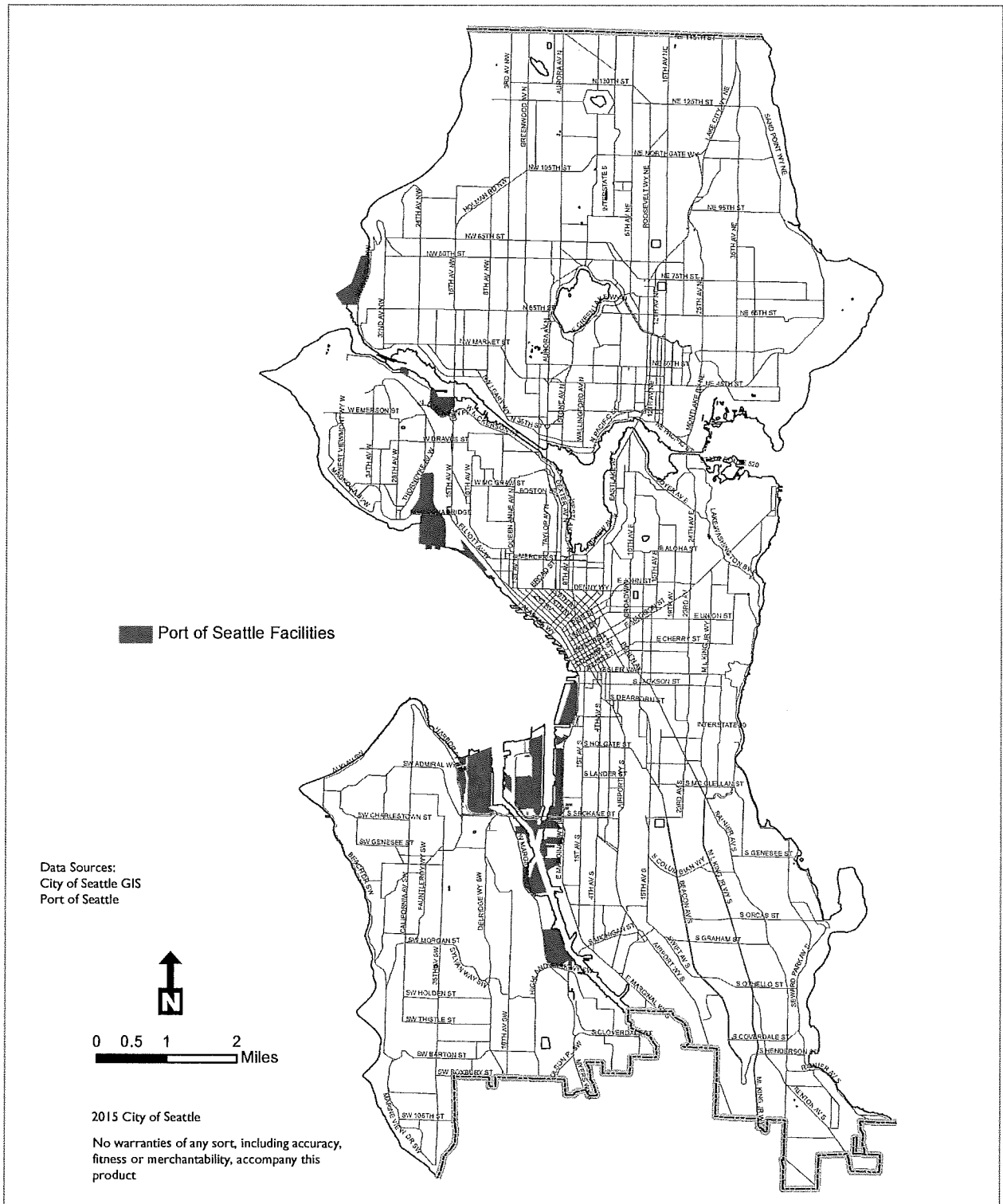

Transportation Appendix Figure A-9

Airports

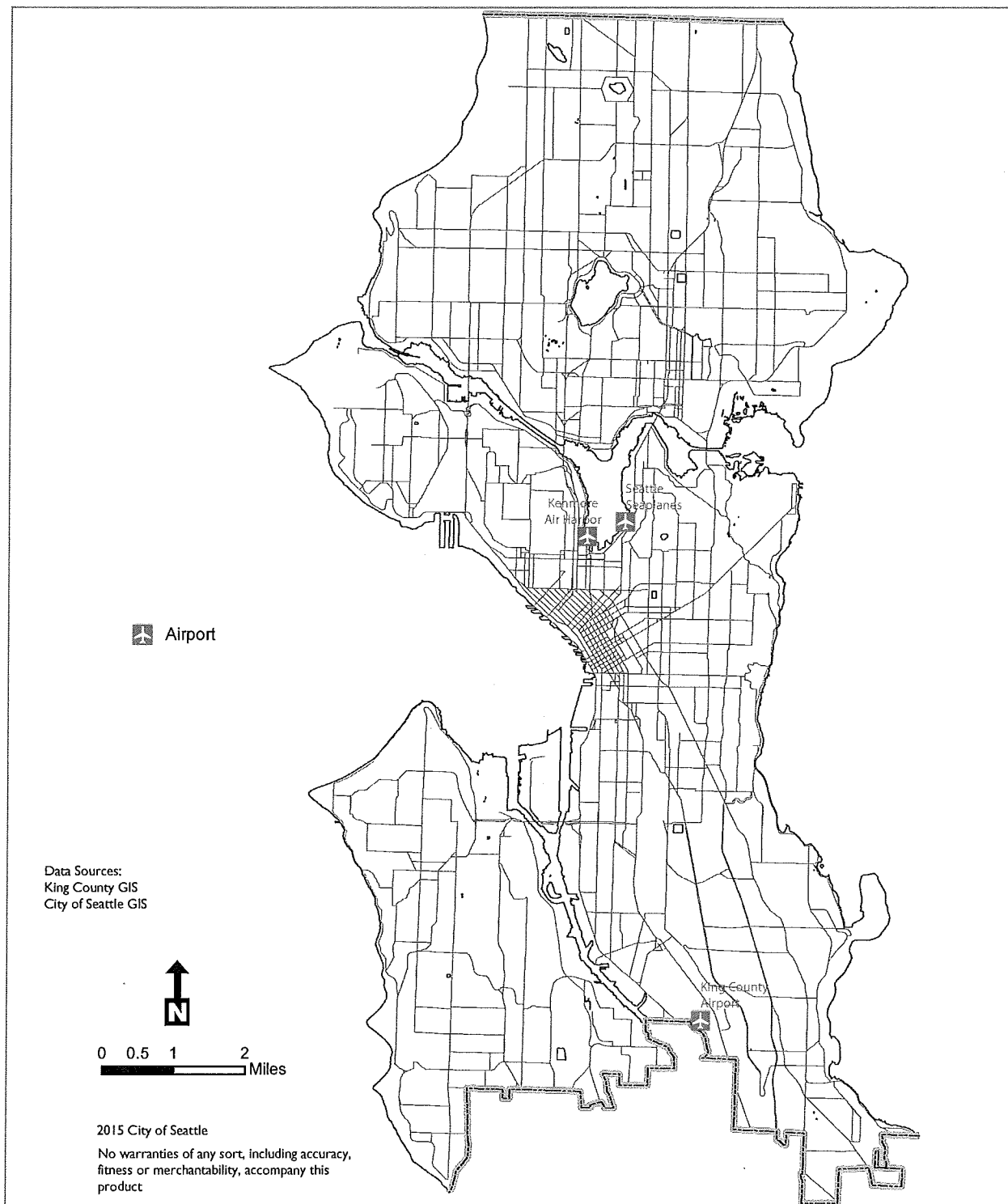

Local Level of Service Standards for Arterials and Transit Routes

Overview

The City measures level of service (LOS) based on the percentage of all trips that are made by single-occupant vehicle (SOV). This measure focuses on increasing the people-moving capacity of the city's roadways by reducing the SOV share of travel. The SOV share of travel is the least space-efficient mode and occurs during the most congested period of the day.

The performance of the overall system will be measured in relation to the reduced share of SOV travel. There are different performance levels defined for eight geographic sectors in the city, recognizing the diverse land use patterns and transportation contexts.

These performance levels differ from the prior screenline-based system. A target SOV mode share has been established for each of the eight sectors of the city and will be applied to every development project. The City's regulatory review will be reduced for each new unit of development.

This mode share measure is consistent with Seattle's comprehensive planning approach because it uses strategies other than adding new capacity for general-purpose travel. Adding vehicle capacity can be costly, and can lead to community disruption and environmental impacts. In many cases, widening arterials may not even be practical or feasible in a mature, developed urban environment. This mode share method of measuring LOS allows the City to use existing current street rights-of-way as efficiently as possible and encourages travel modes other than single-occupant vehicle, especially in peak hours.

Transportation Appendix Figure A-10 summarizes the assumptions about capacity savings and illustrates how lowering the SOV mode share provides "an established minimum capacity of public facilities or services that must be provided per unit of demand or other appropriate measure of need." Transportation Appendix Figure A-11 shows for each city sector the existing condition of SOV mode share and a future SOV target.

Transportation Appendix Figure A-10

Street Capacity Gains with SOV Conversions

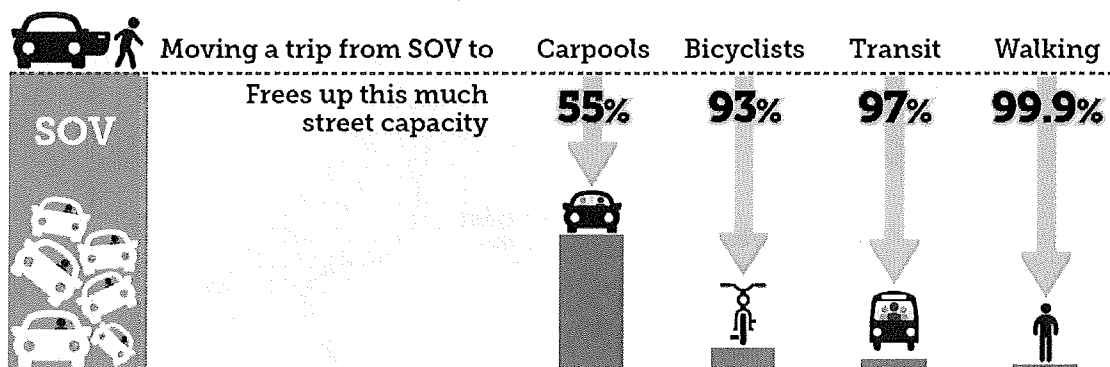

Source: Fehr & Peers, 2016

Transportation Appendix Figure A-11

SOV Mode Share 2015 Performance and 2035 Targets by City Sector

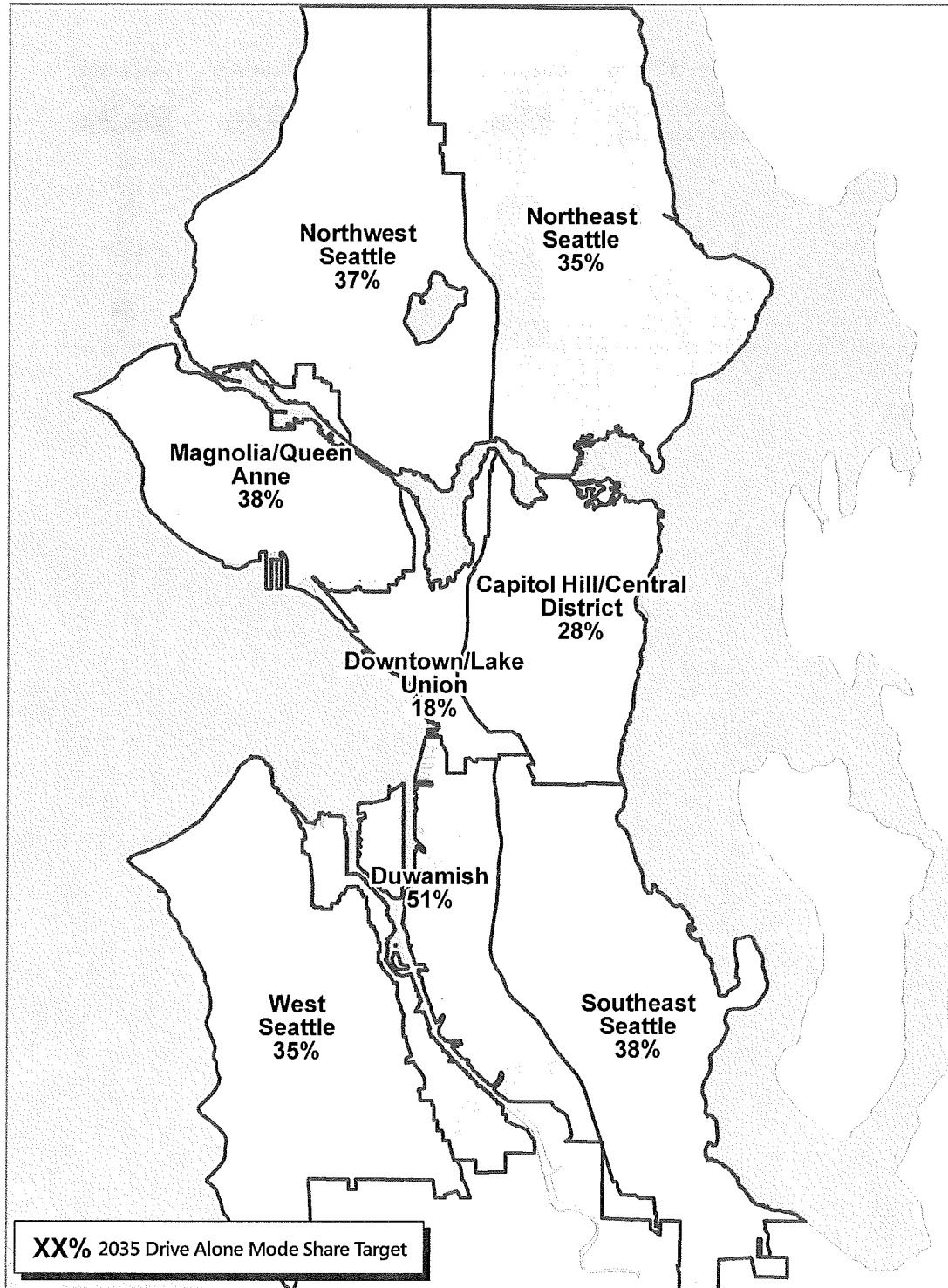

Source: Fehr & Peers, 2016

Traffic Forecasts

The v/c ratios shown in Transportation Appendix Figure A-13 are based on a model consistent with the PSRC Regional Transportation model. However, the City modified PSRC's model to better represent street conditions such as arterial speeds, future transit routing and service levels, the distribution of trips, and choice of transportation modes.

The model's current and 2035 regionwide and city-limit traffic volume estimates are shown in the following tables. The methodology used is to model traffic volumes on arterial streets for the year 2035 and compare them to current conditions.

The modeled volumes are then totaled for all arterials crossing a particular screenline. These totals are then compared to the sum of the arterials' rated capacities. The arterial capacity ratings were systematically reviewed and updated in 2015 to provide a consistent and accurate basis for comparison. This yields a v/c ratio for each direction of traffic at each screenline.

Total vehicle-miles-of-travel (VMT) for the region (per day)

Existing	81.1 million
2035 forecasts	105.4 million (+30%)

Traffic volume at north city limit (vehicles per day)

Existing	360,800
2035 forecasts	467,500 (+30%)

Traffic volume at south city limit (vehicles per day)

Existing	503,600
2035 forecasts	637,300 (+27%)

Traffic volume at east city limit (SR 520 and I-90) (vehicles per day)

Existing	213,000
2035 forecasts	270,500 (+27%)

Transportation Appendix Figure A-12

Screenlines for Traffic Forecast Analysis

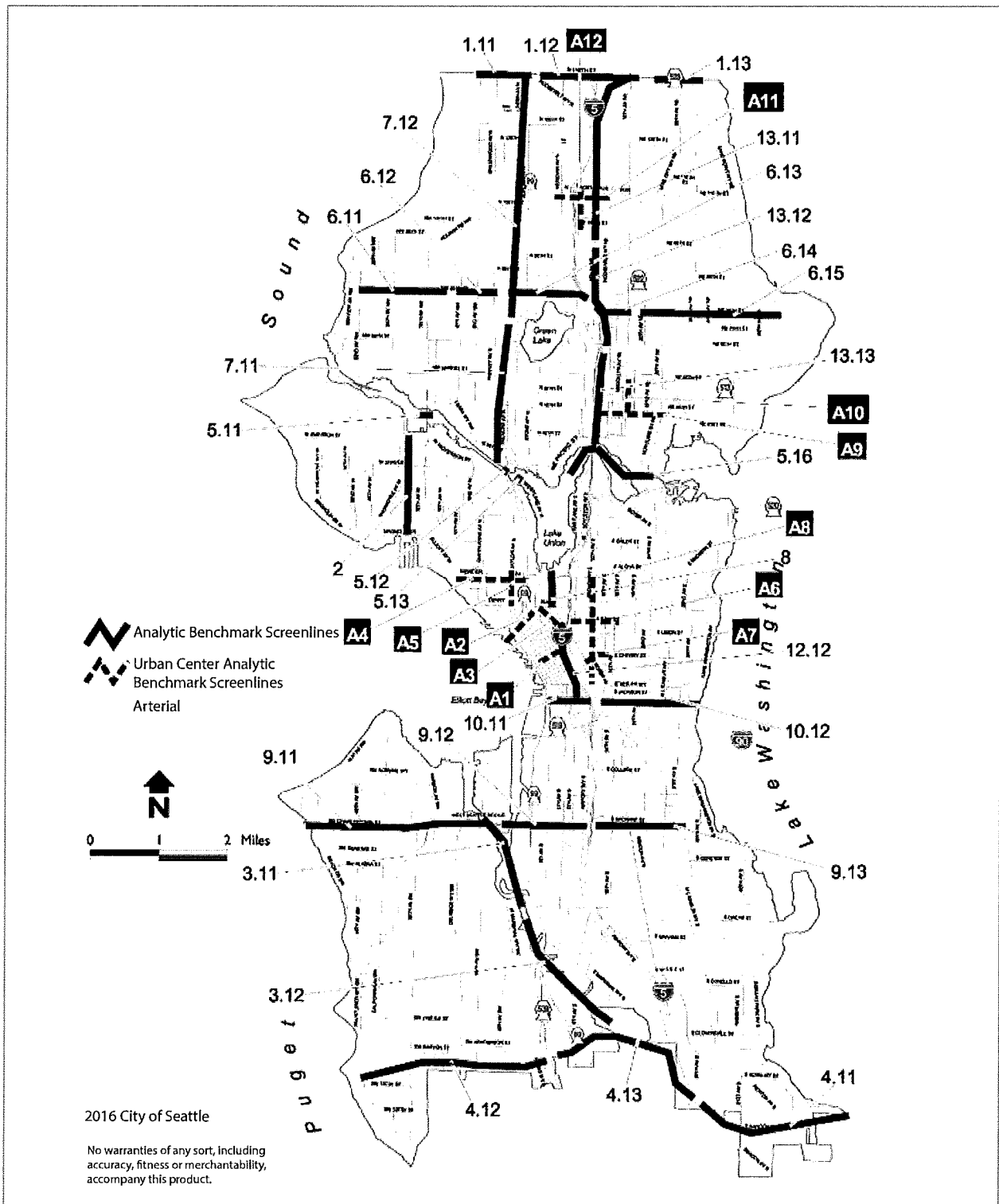

Transportation Appendix Figure A-12 is a map illustrating the location of forty-two screenlines. Thirty of these screenlines were used until 2016 to evaluate level of service performance, and twelve other screenlines (labeled as A1–A12) provide supplemental information about performance in and near Seattle’s urban centers.

A screenline methodology continues to be shown here because it highlights the trend in citywide and regional travel patterns. This methodology recognizes that no single intersection or arterial operates in isolation. Motorists have choices, and they select particular routes based on a wide variety of factors such as avoiding blocking conditions, and minimizing travel times. Accordingly, this analytic methodology focuses on a “traffic-shed” where the screenlines measure groups of arterials among which drivers logically can choose to travel.

Transportation Appendix Figure A-11 lists for each screenline the current conditions and modeled traffic results for the evening peak hour in year 2035, in comparison to analytic benchmarks. These benchmarks are expressed as v/c ratios of 1.0 or 1.20, which indicates a level of use equivalent to 100 percent or 120 percent of rated roadway capacity, measured during peak commute times.

With the anticipated implementation of the Comprehensive Plan, and with the future transportation and circulation conditions in the 2035 evening peak hour, traffic volumes will not exceed any of the screenline benchmarks. These results are evaluated in more detail below.

The forecasted screenline v/c ratios for the year 2035 evening peak hour range from 0.38 to 1.18.

- *Future peak hour traffic conditions will continue to reflect patterns similar to today, with the heaviest congestion at bridge locations including the Ballard Bridge (v/c = 1.18 northbound), the West Seattle Freeway and Spokane Street Bridges (collectively a v/c = 1.15 westbound), the University and Montlake Bridges (collectively a v/c = 0.95 northbound and 1.05 southbound), and the Aurora Bridge (v/c = 0.92 northbound and 0.82 southbound).*
- *Congestion is also projected to increase in other locations as well. This is due to growth or, in some cases, related to future planned road improvements addressing automobiles and bicycles. With respect to the latter factor, this analysis makes conservative assumptions about potential loss of automobile travel lanes. As part of future projects such as bicycle-serving “cycle tracks,” a determination would be made contemporaneous with that project whether and how automobile travel lanes would be diminished. This caveat applies to all references below to future bicycle projects.*
- *Volumes on Aurora Avenue North, Lake City Way North, Greenwood Avenue North, and Third Avenue NW near the north city limits will continue to be heavy during evening*

commutes, and will contribute to conditions that approach or slightly exceed the rated capacity level by 2035 (screenlines 1.11, 1.13).

- *Volumes on MLK Jr. Way South, Rainier Avenue South, and Renton Avenue South near the south city limits will continue to grow, and will contribute to greater use of capacity in the southbound peak direction, approaching but remaining below the rated capacity level for the entire screenline by 2035 (screenline 4.11).*
- *Southbound volumes toward southeast Seattle measured at South Jackson Street and at South Spokane Street will contribute to conditions that reach a v/c ratio of approximately 0.90, or using about 90 percent of rated capacity by 2035. This partly reflects the potential for changes in capacity related to future possible bicycle improvements (screenlines 9.13 and 10.12). See above caveat about future bicycle improvements.*

Transportation Appendix Figure A-13

Freight Assets

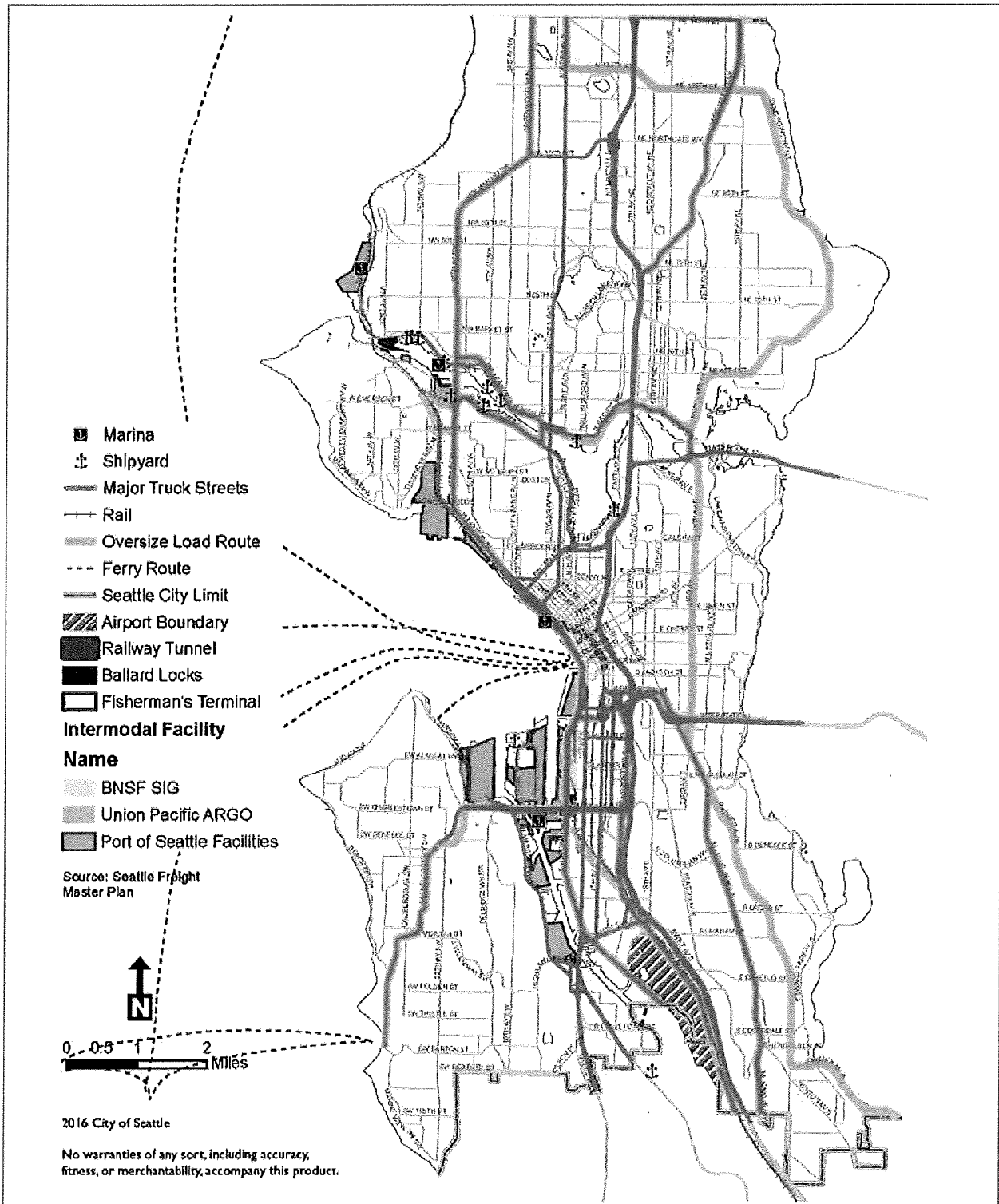

Transportation Appendix Figure A-14

Screenline V/C Ratios

Screenline No.	Screenline Location	Segment	Analytic Benchmark (V/C Ratio)	2013 PM Peak		2025 PM Peak	
				Dir.	V/C Ratio	Dir.	V/C Ratio
1.11	North City Limit	3rd Ave NW to Aurora Ave N	1.20	NB	0.70	NB	1.04
				SB	0.57	SB	0.80
1.12	North City Limit	Meridian Ave N to 15th Ave NE	1.20	NB	0.41	NB	0.77
				SB	0.32	SB	0.64
1.13	North City Limit	30th Ave NE to Lake City Way NE	1.20	NB	0.73	NB	0.97
				SB	0.63	SB	0.84
2	Magnolia	Magnolia Bridge to W. Emerson Place	1.00	EB	0.53	EB	0.56
				WB	0.55	WB	0.56
3.11	Duwamish River	West Seattle Freeway and S. Spokane St	1.20	EB	0.61	EB	0.69
				WB	0.87	WB	1.15
3.12	Duwamish River	1st Ave S and 16th Ave S	1.20	EB	0.35	EB	0.38
				WB	0.52	WB	0.55
4.11	South City Limit	M L King Jr Way to Rainier Ave S	1.00	NB	0.47	NB	0.56
				SB	0.63	SB	0.93
4.12	South City Limit	Marine View Drive SW to Myers Way S	1.00	NB	0.37	NB	0.56
				SB	0.42	SB	0.72
4.13	South City Limit	SR 99 to Airport Way S	1.00	NB	0.41	NB	0.58
				SB	0.45	SB	0.74
5.11	Ship Canal	Ballard Bridge	1.20	NB	0.99	NB	1.18
				SB	0.52	SB	0.72
5.12	Ship Canal	Fremont Bridge	1.20	NB	0.71	NB	0.79
				SB	0.54	SB	0.71
5.13	Ship Canal	Aurora Ave N Bridge	1.20	NB	0.81	NB	0.92
				SB	0.62	SB	0.82

ScreenLine No.	ScreenLine Location	Segment	Analytic Benchmark (V/C Ratio)	2013 PM Peak		2035 PM Peak	
				Dir.	V/C Ratio	Dir.	V/C Ratio
5.16	Ship Canal	University and Montlake Bridges	1.20	NB	0.80	NB	0.95
				SB	0.87	SB	1.05
6.11	South of NW 80th St	Seaview Ave NW to 15th Ave NW	1.00	NB	0.45	NB	0.53
				SB	0.43	SB	0.50
6.12	South of NW 80th St	8th Ave NW to Greenwood Ave N	1.00	NB	0.66	NB	0.87
				SB	0.49	SB	0.78
6.13	South of NE 80th St	Linden Ave N to 1st Ave NE	1.00	NB	0.44	NB	0.54
				SB	0.27	SB	0.41
6.14	South of NE 80th St	5th Ave NE to 15th Ave NE	1.00	NB	0.65	NB	0.74
				SB	0.53	SB	0.67
6.15	South of NE 80th St	20th Ave NE to Sand Point Way NE	1.00	NB	0.49	NB	0.63
				SB	0.47	SB	0.58
7.11	West of Aurora Ave N	Fremont Pl N to N 65th St	1.00	EB	0.48	EB	0.56
				WB	0.58	WB	0.65
7.12	West of Aurora Ave N	N 80th St to N 145th St	1.00	EB	0.50	EB	0.57
				WB	0.57	WB	0.65
8	South of Lake Union	Valley Street to Denny Way	1.20	EB	0.78	EB	0.91
				WB	0.78	WB	0.82
9.11	South of Spokane St	Beach Dr. SW to W Marginal Way SW	1.00	NB	0.51	NB	0.59
				SB	0.58	SB	0.72
9.12	South of Spokane St	E Marginal Way S to Airport Way S	1.00	NB	0.47	NB	0.60
				SB	0.52	SB	0.70
9.13	South of Spokane St	15th Ave S to Rainier Ave S	1.00	NB	0.45	NB	0.66
				SB	0.58	SB	0.89
10.11	South of S Jackson St	Alaskan Way S to 4th Ave S	1.00	NB	0.56	NB	0.64
				SB	0.65	SB	0.84

Screenline No.	Screenline Location	Segment	Analytic Benchmark (V/C Ratio)	2013 PM Peak		2015 PM Peak	
				Dir.	V/C Ratio	Dir.	V/C Ratio
10.12	South of S Jackson St	12th Ave S to Lakeside Ave S	1.00	NB	0.48	NB	0.75
				SB	0.58	SB	0.91
12.12	East of CBD	S Jackson St to Howell St	1.20	EB	0.35	EB	0.39
				WB	0.45	WB	0.52
13.11	East of I-5	NE Northgate Way to NE 145th St	1.00	EB	0.71	EB	0.86
				WB	0.59	WB	0.79
13.12	East of I-5	NE 65th St to NE 80th St	1.00	EB	0.44	EB	0.51
				WB	0.41	WB	0.53
13.13	East of I-5	NE Pacific St to NE Ravenna Blvd	1.00	EB	0.55	EB	0.63
				WB	0.54	WB	0.65
A1	North of Seneca St	1st Ave to 6th Ave	NA	NB	0.55	NB	0.67
				SB	0.40	SB	0.59
A2	North of Blanchard	Elliott Ave to Westlake Ave	NA	NB	0.43	NB	0.55
				SB	0.36	SB	0.51
A3	East of 9th Ave	Lenora St to Pike St	NA	EB	0.36	EB	0.44
				WB	0.32	WB	0.43
A4	South of Mercer St	Elliott Ave W to Aurora Ave N	NA	NB	0.78	NB	0.92
				SB	0.51	SB	0.78
A5	East of 5th Ave N	Denny Way to Valley St	NA	EB	0.39	EB	0.54
				WB	0.40	WB	0.46
A6	North of Pine St	Melrose Ave E to 15th Ave E	NA	NB	0.45	NB	0.53
				SB	0.50	SB	0.62
A7	North of James St– E Cherry St	Boren Ave to 14th Ave	NA	NB	0.62	NB	0.72
				SB	0.57	SB	0.77
A8	West of Broadway	Yesler Way to E Roy St	NA	EB	0.50	EB	0.56
				WB	0.60	WB	0.71

Screenline No.	Screenline Location	Segment	Analytic Benchmark (V/C Ratio)	2033 PM Peak		2035 PM Peak	
				Dir.	V/C Ratio	Dir.	V/C Ratio
A9	South of NE 45th St	7th Ave NE to Montlake Blvd NE	NA	NB	0.70	NB	0.78
				SB	0.70	SB	0.74
A10	East of 15th Ave NE	NE 45th St to NE 52nd St	NA	EB	0.52	EB	0.53
				WB	0.46	WB	0.49
A11	South of Northgate Way (N/NE 110th St)	N Northgate Way to Roosevelt Way NE	NA	NB	0.50	NB	0.65
				SB	0.49	SB	0.65
A12	East of 1st Ave NE	NE 100th St to NE Northgate Way	NA	EB	0.48	EB	0.65
				WB	0.62	WB	0.95

Results for areas around Seattle’s six urban centers are summarized as follows.

Downtown: Screenlines 10.11, 12.12, A1, A2, and A3 pass through or along the edge of the Downtown Urban Center, some encompassing north–south avenues, and some encompassing east–west streets. Higher v/c ratios reflect higher future volumes on most avenues and streets, and increased congestion. However, for all five of these screenlines, the future v/c ratios will remain below 1.0 in 2035 with Comprehensive Plan implementation.

Uptown: For the Uptown Urban Center, screenline A4 is an east–west screenline south of Mercer Street extending as far west as Elliott Avenue West and east to include Aurora Avenue North, while screenline A5 is drawn north–south between Fifth Avenue North and Taylor Avenue North. The predicted increase in congestion, above a v/c ratio of 0.90 for northbound traffic, relates to major traffic volumes on Elliott Avenue West and Aurora Avenue North.

It also relates to a possible reduction in capacity on Fifth Avenue North if bicycle improvements reduce lanes for motorized vehicle travel. Measures of east–west travel congestion will worsen but remain well below a 1.0 v/c ratio; improvements enabling a two-way Mercer Street add capacity in the westbound direction.

South Lake Union: For the South Lake Union Urban Center, screenline 8 is drawn north–south at Fairview Avenue North. Volumes will continue to increase, and road improvements will continue to occur for a number of years into this planning period. The v/c ratios for both directions along this screenline will decline by 2035, with higher evening congestion levels in the eastbound direction reflected by a v/c ratio of 0.91. However, the ratio will remain below the 1.20 v/c ratio.

First Hill/Capitol Hill: Screenlines A6, A7, and A8 are drawn through the First Hill/Capitol Hill Urban Center. Screenline 12.12 is on the west edge of the First Hill/Capitol Hill Urban Center adjacent to Downtown. For all four of these screenlines, the year 2035 v/c ratios under the Comprehensive Plan will remain well below the 1.20 v/c ratio that applies to screenline 12.12. Although the findings for screenline A7 and A8 illustrate a somewhat elevated congestion level in all directions in the area between Boren Avenue and 14th Avenue by 2035, near James Street, and for travel east–west across Broadway, these areas are currently often congested at peak hours.

University District: For the University District Urban Center, screenlines 5.16 and 13.13 cover the south and west boundaries of the urban center, while screenline A9 passes east–west through the center and screenline A10 is drawn north–south through the center. Higher v/c ratios suggest higher volumes and a degree of increased congestion by 2035. However, the year 2035 v/c ratios will be below 1.0 for all four of these screenlines in the peak commuting directions, and at screenline A-10, the v/c ratio is projected to be .49 in the year 2035. At the University and Montlake Bridges, evening peak hour volumes will continue to be high, and the southbound volumes on the University Bridge are projected to exceed the northbound volumes. This may reflect the diverse range of destinations of university employees and students. Given the pass-through nature of many evening commuters, the projected volumes for Roosevelt Way NE and Montlake Boulevard NE would continue to be high and grow slightly by 2035.

Northgate: For the Northgate Urban Center, screenline A11 is drawn east–west just south of Northgate Way, while screenline A12 passes north–south just east of First Avenue NE. Screenline 13.11 also measures east–west traffic crossing Fifth Avenue NE. The year 2035 v/c ratios for these three screenlines will worsen but remain below 1.0, with the most significant increase in volume over capacity being at screenline A-12, westbound, with an increase in v/c from .88 to .95. The measures of east–west traffic both indicate increasing congestion that will reach v/c ratio levels of approximately 0.8 to 0.9, meaning much of the available capacity will be used by 2035. The analysis also shows relatively high volumes west of I-5, for westbound Northgate Way, and for both directions of Meridian Avenue North.

State Highway Level of Service Standards

There are two different types of State highways with segments in Seattle with two different LOS standards. The larger facilities are “Highways of Statewide Significance” (HSS). These are I-5, I-90, SR 99, SR 509, SR 519, SR 520, and SR 522. Highways of Statewide Significance include, at a minimum, interstate highways and other principal arterials needed to connect major communities in the state.

For all the HSS, the State defines a LOS standard of “D.” RCW 36.70A.070(6)(a)(iii)(C) provides that local jurisdictions’ Comprehensive Plans should indicate a LOS for State-owned facilities, but specifies that local concurrency requirements do not apply to the HSS routes.

Including LOS standards for HSS is a communication and coordination tool in local plans, so that the State of Washington has a current understanding of performance on their facilities.

Non-HSS facilities (also called “Highways of Regional Significance”) in Seattle are SR 513, SR 523, and SR 99 (only those portions south of South Holden Street). These highways are monitored by the Puget Sound Regional Council for regional planning purposes. For these highways the LOS standard is “E/mitigated.”

State-Funded Highway Improvements & Local Improvements to State Highways

The City of Seattle will continue to coordinate with WSDOT for consistency in plans and projects. Transportation Appendix Figure A-15 shows the known anticipated major projects for the metropolitan area that will address State highways and facilities including ferries, and an indication of project status as applicable today and/or into the future until 2035. These are the primary projects within Seattle and the broader metropolitan area that will affect the functioning of segments of State highways within city limits. Planned local system improvements are diverse; these are addressed as presented in the City’s functional plans, including but not limited to the Transit Master Plan, Pedestrian Master Plan, and the Bicycle Master Plan.

Transportation Appendix Figure A-15

State Highway Project List

Project	2015	2035
SR 99 Tunnel (with Tolls)		x
SR 520 HOV Lanes to Montlake	x	x
Second Montlake Bascule Bridge		
SR 520 Tolling	x	x
I-90 HOV Lanes	x	x
I-405 Widening (SR 167 to SR 527)		x
Passenger-Only Ferries (Kingston, Southworth, Juanita)		
Montlake Blvd NE HOV Lane and ITS Improvements		x

Estimated Traffic Improvements to State-Owned Transportation Facilities

Transportation Appendix Figure A-16 includes, for State highways, information about existing conditions and future modeled conditions for 2035. This data is organized by “average annual daily traffic” (AADT), “average weekday daily traffic” (AWDT), and a calculation of the modeled increase in AWDT for each highway segment expressed as a percentage.

AWDT is emphasized here as an analytical tool because it is the most representative of the peak commuting periods when volumes and congestion are highest. Existing conditions are based on available information from WSDOT, with factoring to estimate AADT in certain locations. By contrast, the modeled future conditions forecasts AWDT. These raw model volume results for 2035 were further analyzed by using the “difference method” and are methodologically consistent with findings in the Environmental Impact Statement for this Comprehensive Plan.

Forecasts are for particular components of State facilities including HOV lanes, express lanes, and collector-distributor lane volumes. Note the explanation above of the different LOS for state highways designated as “HSS” and those designated as Highways of Regional Significance.

Transportation Appendix Figure A-16

State Highway Traffic Volumes 2013–2035

State Highway	Location (roads here are cross-streets that show approx. endpoints of State highway segments)	Dir.	2013 AADT	2013 AWDT Volume	2035 AADT Volume	2035 AWDT Volume	% Change in AWDT from 2013 to 2035
I-5	Boeing Access Rd.–Swift Avenue S	NB	95,900	100,300	115,100	120,300	20%
		SB	104,500	109,200	121,000	126,500	16%
I-5	Corson–Columbia Way S/West Seattle Bridge	NB	103,800	108,600	119,400	124,900	15%
		SB	121,500	127,100	135,400	141,600	11%
I-5	I-90–James Street	NB	133,200	139,300	162,400	169,900	22%
		SB	146,900	153,600	164,000	171,600	12%
I-5	Lakeview Blvd. E–SR 520	NB	123,700	139,800	141,800	160,200	15%
		SB	114,200	129,000	131,600	148,700	15%

State Highway	Location (roads here are cross streets that show approx. endpoints of State highway segments)	Dir.	2011 AADT	2011 AWDT Volume	2015 AADT Volume	2015 AWDT Volume	% Change in AWDT from 2011 to 2015
I-5	SR 520–NE 50th Street	NB	133,400	135,900	155,200	158,000	16%
		SB	121,900	124,100	137,600	140,100	13%
I-5	NE 65th Street–SR 522	NB	117,700	119,900	137,300	139,800	17%
		SB	119,000	121,200	135,400	137,800	14%
I-5	NE 130th Street–NE 145th Street	NB	98,000	99,800	114,500	116,600	17%
		SB	98,700	100,400	116,100	118,200	18%
I-90	Rainier Avenue S–Lk. Washington (mainline)	EB	65,000	70,300	82,600	89,300	27%
		WB	68,100	72,500	89,900	95,800	32%
SR 991	14th Avenue S–S Cloverdale Street	NB	16,300	19,200	21,200	25,000	30%
		SB	13,700	16,200	15,900	18,700	15%
SR 99	W Marginal Wy S–S Michigan Street (1st Avenue S Bridge)	NB	44,000	48,500	56,900	62,800	29%
		SB	42,000	46,300	54,200	59,800	29%
SR 99	E Marginal Wy–W. Seattle Bridge	NB	21,300	23,500	30,100	33,200	41%
		SB	17,700	19,500	25,400	28,100	44%
SR 99	1st Avenue S Ramps–Seneca/Spring	NB	33,900	37,400	30,900	34,000	-9%
		SB	36,100	39,800	29,200	32,200	-19%
SR 99	Raye Street–Bridge Way N	NB	32,900	36,000	42,100	46,000	27%
		SB	36,100	39,500	46,400	50,800	28%
SR 99	Winona Avenue N–N 80th Street	NB	14,700	16,100	18,600	20,300	26%
		SB	17,300	18,900	22,900	25,000	32%
SR 99	Roosevelt Way N–N 145th Street	NB	14,400	15,700	20,900	22,800	45%
		SB	14,600	16,000	21,800	23,800	48%
SR 509	S 112th Street–S Cloverdale Street	NB	18,200	21,400	25,200	29,800	39%
		SB	14,900	17,500	18,600	22,000	26%
SR 513	SR 520 Ramps–NE Pacific Street (Montlake Br.)	NB	16,600	18,100	20,300	22,200	23%
		SB	19,400	21,300	22,600	24,700	16%

State Highway	Location (rows here are cross-streets that show approx. endpoints of State highway segment)	Dir.	2023 AADT	2033 AWDT Volume	2035 AADT Volume	2038 AWDT Volume	% Change in AWDT from 2023 to 2035
SR 513	Montlake Blvd. NE–Union Bay Pl. NE	EB	18,600	20,300	18,800	20,500	0%
		WB	19,400	21,300	19,400	21,300	0%
SR 522	Roosevelt Way NE–12th Avenue NE	EB	12,300	13,500	14,100	15,400	16%
		WB	15,700	17,200	18,000	19,700	15%
SR 522	NE 137th Street–NE 145th Street	NB	15,100	16,500	18,200	19,900	20%
		SB	16,900	18,500	22,800	24,900	35%
SR 523	5th Avenue NE–15th Avenue NE	EB	13,900	15,200	14,100	15,500	2%
		WB	13,100	14,300	14,800	16,100	13%
SR 520	Between I-5 and Montlake Blvd.	EB	30,000	33,900	34,500	39,000	15%
		WB	42,600	48,100	48,700	55,000	14%
SR 520	Between Montlake Blvd. and Lake Washington	EB	30,100	33,900	35,700	40,200	19%
		WB	32,100	36,300	39,200	44,400	22%
SR 519	1st Avenue S.–4th Avenue S.	EB	14,800	16,100	18,400	20,100	25%
		WB	12,200	13,400	12,200	13,400	0%

Findings in Transportation Appendix Figure A-16 also show impacts on various segments of state highways and are described more specifically as follows:

I-5 Downtown and North of Downtown

Future average weekday daily volumes (AWDT) will increase by between 13 and 18 percent by 2035 in both directions in the four studied segments of I-5 north of Downtown. Daily volumes in the central segment of I-5 through Downtown will increase by between 12 and 22 percent and will be the most-used portions of I-5 in Seattle. Future volumes in segments farther from Downtown will also grow but volumes will be comparatively lesser than in the segments nearest Downtown.

This is an expected pattern, given the number of motorists who use I-5 and enter or exit from places including the University District, Wallingford, Green Lake, Roosevelt, and other neighborhoods in northwest and northeast Seattle. The added volumes through the day could exacerbate congestion, most notably during peak commuting periods, which could diminish overall freeway efficiency and performance.

I-5 South of Downtown

Future AWDT volumes will increase by between 15 and 20 percent northbound and by between 11 and 16 percent southbound by 2035 in two studied segments south of Downtown. Approaching Downtown from the south, the segment between I-90 and James Street would experience an approximately 22 percent increase in AWDT, likely due to volume contributions from I-90 and other local sources. AWDT volumes on I-5 south of Downtown, ranging from approximately 120,000 to 140,000 vehicle trips, would be about 25 percent lower than for the segment of I-5 just north of Downtown.

I-90

I-90 will experience AWDT increases of between 27 and 32 percent by 2035, with westbound volumes increasing to about 96,000 per day, slightly exceeding eastbound volumes.

SR 520

For this highway that has experienced volume decreases due to the initiation of tolling and construction east of Lake Washington, the projected future conditions are for increases in AWDT volumes of between 15 to 23 percent by 2035. This will be equivalent to an increase of about 5,000 to 6,000 vehicles in the eastbound direction, reaching about 40,000 vehicles per day east of Montlake, and about 44,500 vehicles per day in the westbound direction east of Montlake. Closer to I-5, the projected AWDT will reach approximately 55,000 vehicles in the westbound direction by 2035. Tolling is likely to continue to limit the rate of growth in usage over time on SR 520.

SR 99 Downtown and North of Downtown

This highway is anticipated to operate in a tunnel through Downtown by 2035, which may mean a change in volume trends compared to current operations. For three studied segments of SR 99 north of Downtown, future AWDT would increase by between 28 to 34 percent between the lower Queen Anne and Green Lake vicinities, and would increase by between 45 to 50 percent in the segment near the north city limits at North 145th Street.

The projected volumes in this vicinity would be highest in the portion nearest Lake Union and the Ship Canal, reaching between 46,000 to 50,000 vehicles per day AWDT in each direction, while in more northern segments, volumes would range between 20,000 to 25,000 vehicles per day in each direction.

SR 99 South of Downtown

South of Downtown, SR 99 provides access to the SODO and Greater Duwamish industrial areas, as well as southwest Seattle and points south including Burien and Tukwila. South

of South Park, SR 99 reconnects to I-5 in Tukwila. The First Avenue South Bridge crosses the Duwamish Waterway and accommodates traffic to/from Georgetown and the King County International Airport vicinity as well. The variety of its connections and configurations leads to different trends for projected AWDT.

These include (1) anticipated AWDT increases of about 29 percent in each direction at the First Avenue South Bridge (approximately 60,000 to 63,000 vehicles in each direction); (2) increased volumes in the SODO area north of Georgetown of 40 to 44 percent (28,000 to 33,000 vehicles in each direction) and similar gains in the southern direction. These trends likely reflect anticipated increases in commuting traffic and projected traffic growth over time, contributed by nearby neighborhoods like Lake City and Northgate.

SR 513 (Montlake Boulevard to Sand Point Way)

Future AWDT volumes would increase by about 17 to 25 percent in this segment that includes the Montlake Bridge just north of SR 520. This would represent AWDT volumes of approximately 25,000 vehicles per day southbound and 22,600 vehicles per day northbound. This would exacerbate congestion during peak hours in this route that is used heavily for daily commuting. However, other analysis indicates that the future 2035 conditions would still meet the v/c ratio analytic benchmark for the applicable screenline that covers both the University Bridge and the Montlake Bridge.

SR 519 (Edgar Martinez Way)

Future volumes (AWDT) would increase by about 23 percent in the eastbound direction for this segment that provides access to/from the Port of Seattle and SODO industrial area near the major sports stadiums. No increase in the westbound direction was projected in the modeling.

SR 523 (NE 145th Street East of I-5)

This route provides east–west access from Lake City and Lake Forest Park to I-5 and is at the north city limits. Future volumes (AWDT) would increase modestly by 3 to 13 percent, reaching volumes of about 16,000 vehicles in each direction by 2035.

Impacts on Adjacent Jurisdictions

Four jurisdictions are adjacent to the City of Seattle: the cities of Shoreline and Lake Forest Park along Seattle’s north boundary and Tukwila and King County along Seattle’s south boundary. Several major arterials that connect to streets in these jurisdictions near the Seattle borders were selected for analysis. For each arterial, the existing PM peak hour traffic volume and forecasted year 2035 traffic volumes were compared to the rated capacity of the arterial, yielding a v/c ratio. The results of this analysis are shown in Transportation Appendix Figure A-17.

Transportation Appendix Figure A-17

Arterials Reaching Adjacent Jurisdiction PM Peak Hour Capacities, Volumes, and V/C Ratios

Major arterials within Seattle at the Seattle/King County-Shoreline-Lake Forest Park Border (145th Street)

Arterial	Existing (2004) PM Peak Hour						2035 PM Peak Hour					
	Outbound			Inbound			Outbound			Inbound		
	Capacity	Volume	V/C Ratio	Capacity	Volume	V/C Ratio	Capacity	Volume	V/C Ratio	Capacity	Volume	V/C Ratio
Greenwood Ave N	1,940	1,223	0.63	1,940	838	0.45	1,940	1,770	0.91	1,940	1,221	0.63
Aurora Ave N	2,100	1,681	0.80	2,000	1,223	0.61	2,100	2,427	1.16	2,000	1,879	0.94
Meridian Ave N	770	312	0.41	770	162	0.21	770	590	0.77	770	430	0.56
5th Ave NE	770	366	0.48	770	205	0.27	770	550	0.71	770	360	0.47
15th Ave NE	2,040	891	0.44	2,040	640	0.31	1,010	891	0.88	1,010	727	0.72
30th Ave NE	770	433	0.56	770	365	0.47	770	592	0.77	770	560	0.73
Lake City Way	2,150	1,697	0.79	2,040	1,388	0.68	2,150	2,230	1.04	2,040	1,790	0.88

Major arterials within Seattle just north of Seattle/King County Border

Arterial	Existing (2004) PM Peak Hour						2035 PM Peak Hour					
	Outbound			Inbound			Outbound			Inbound		
	Capacity	Volume	V/C Ratio	Capacity	Volume	V/C Ratio	Capacity	Volume	V/C Ratio	Capacity	Volume	V/C Ratio
26th Ave SW	770	401	0.52	770	336	0.44	770	522	0.68	770	380	0.49
16th Ave SW	770	292	0.38	770	216	0.28	770	540	0.70	770	250	0.32
Olson Pl SW	2,040	1,442	0.71	2,040	1,070	0.52	1,010	1,442	1.43	1,010	1,070	1.06
Myers Way S	1,540	264	0.17	1,540	190	0.12	1,540	670	0.43	1,540	210	0.14
8th Ave S	770	93	0.12	770	99	0.13	770	222	0.29	770	99	0.13

Arterial	Existing (2014) PM Peak Hour						2035 PM Peak Hour					
	Outbound			Inbound			Outbound			Inbound		
	Capacity	Volume	V/C Ratio	Capacity	Volume	V/C Ratio	Capacity	Volume	V/C Ratio	Capacity	Volume	V/C Ratio
14th Ave S	1,540	498	0.32	1,540	394	0.26	1,540	830	0.54	1,540	590	0.38
Renton Ave S	770	570	0.74	770	393	0.51	770	940	1.22	770	501	0.65
Rainier Ave S	1,460	967	0.66	1,460	663	0.45	1,460	1,410	0.97	1,460	991	0.68
E Marginal Way S	2,040	699	0.34	2,040	703	0.34	2,040	1,020	0.50	2,040	779	0.38
Airport Way S	2,000	756	0.38	2,000	356	0.18	1,000	1,123	1.12	1,000	822	0.82
M L King Jr. Way S	2,040	1,297	0.64	2,040	1,076	0.53	2,040	1,650	0.81	2,040	1,078	0.53
51st Ave S	770	351	0.46	770	219	0.28	770	690	0.90	770	270	0.35

For all but five instances for the arterials shown in Transportation Appendix Figure A-17, the PM peak hour v/c ratio is below 1.0, indicating that there currently is remaining vehicle capacity and that the capacity will continue into the forecasted future. Exceptions are:

Aurora Avenue North (SR 99), as the primary north-south highway arterial to/from Shoreline, is projected to experience considerable growth in evening peak hour volumes by 2035 (nearly 750 added vehicles), which will raise the projected northbound v/c ratio from 0.80 to 1.16.

Lake City Way (SR 522), as the primary north-south highway arterial in north Seattle to/from Lake Forest Park, is projected to experience considerable growth in evening peak hour volumes by 2035 (530 added vehicles), which will raise the projected northbound v/c ratio from 0.79 to 1.04.

Olson Place SW, a route to/from White Center and Burien, may experience a projected v/c ratio of 1.43 in the peak westbound direction by 2035, but this is tempered by a recognition that the conservative analysis of road capacity predicts a reduced capacity with a possible future bicycle improvement, and the future volumes for 2035 are not otherwise projected to increase over existing 2014 volumes. A similar effect on the eastbound direction of travel on Olson Place SW leads to a projected congestion level measured as a 1.06 v/c ratio. Future bicycle facility design would determine whether vehicle lanes would actually be reduced; given the street's width, such reductions ultimately might not be needed.

Renton Avenue South, a route to/from Skyway and the city of Renton, is projected to experience growth of approximately 370 vehicles in the southbound direction by 2035, which will raise the corresponding v/c ratio to 1.22.

Airport Way (a route to/from Tukwila), like Olson Place SW, may be affected in its capacity by a future possible bicycle improvement, and given projected increases in peak hour traffic southbound (nearly 370 added vehicles) could experience congestion measured as a v/c ratio of 1.12.

In other locations, including Rainier Avenue South and MLK Jr. Way South, both routes to Renton, projected v/c ratios of 0.97 and 0.81 respectively, indicating future increases in volume and probable congestion.

These modeled traffic volume and v/c findings for 2035 reflect growth not only under Seattle's Comprehensive Plan, but also the probable growth in the adjacent jurisdictions and throughout the central Puget Sound region that contributes to total traffic growth. Much of the traffic on these arterials is and will continue to be through-traffic, although the destinations of some motorists will be to and from Seattle as well as the neighboring jurisdictions.

Intergovernmental Coordination Efforts

This section describes the City's intergovernmental coordination efforts during the development of the Comprehensive Plan and potential impacts of the plan on the transportation systems of adjacent jurisdictions.

Seattle is an active member of the PSRC, which is charged with certifying that local transportation plans are consistent with regional plans and goals. The City supports PSRC's Vision 2040, the regional growth strategy that describes linking high-density residential and employment centers throughout the region by high-capacity transit and promoting a multimodal transportation system. Vision 2040's goals are carried forward by this Comprehensive Plan.

The PSRC provides population, employment, and transportation data to Seattle and other jurisdictions. Coordination is established via this centralized information resource. The PSRC is charged with allocating certain federal funds. Seattle has participated in establishing the criteria and selection process to determine how funds will be distributed among transportation projects.

The City of Seattle cooperates with WSDOT and the PSRC regarding improvements to State transportation facilities and services and to ensure that the City's plans are consistent with the State Transportation Plan and the Transportation 2040 plan. The PSRC monitors State highways of regional significance for regional planning purposes.



Housing Appendix

Introduction

Broad Policy Framework

The state Growth Management Act (GMA) requires each local jurisdiction to include an inventory and analysis of existing and projected housing needs in its Comprehensive Plan. King County's Countywide Planning Policies (CPPs) provide additional direction and guidance for the inventory and analysis of local housing supply and housing needs.

As required, the analysis provided in the Housing Appendix addresses existing and projected housing needs for all economic segments in Seattle as well as for the special-needs populations in the community.

Contents of Housing Appendix

The first sections of the appendix describe the City's projections for the total amount of housing needed to accommodate growth in Seattle and the amount of capacity within the city for future residential development at a range of housing densities.

The next sections of this appendix provide information on the characteristics of Seattle's population and households. This includes data on the extent of housing cost burdens and other indicators of housing-related needs experienced by Seattle's extremely low, very-low, and low-income households. Information is also presented on Seattle's special-needs populations, including homeless people. Information on disparities in housing cost burdens and homelessness by race and ethnicity is presented in order to support planning consistent with the City's Race and Social Justice Initiative (RSJI) and the Seattle Comprehensive Plan core value of social equity.

Subsequent sections in this appendix describe recent growth and characteristics of Seattle's existing housing market, and present information on the affordability of the existing rental and owner housing supply. An analysis is included on the gaps between existing housing need and the amount of rental housing affordable and available to lower-income households. Projections are then provided on the amount of housing needed to accommodate growth by income level.

Sections near the end of the appendix describe the City's strategies for addressing affordable housing, inventory rent/income-restricted housing within Seattle, and provide rough projections for continued production of rent/income-restricted housing.

Information on the data sources employed in the Housing Analysis is provided below.

Data Sources

One of the main sources used is a special tabulation of American Community Survey (ACS) prepared by the US Census Bureau for the US Department of Housing and Urban Development (HUD), otherwise known as the Consolidated Housing Affordability Strategy (CHAS) data.

Certain aspects of the CHAS data are important to note. As sample-based estimates, the CHAS estimates, like other ACS estimates, carry margins of error. These margins of error can be substantial, particularly for small groups of households. To provide reasonably reliable statistics at the local level, HUD obtains CHAS tabulations based on ACS data pooled over a period of five years.

The five-year CHAS estimates from the 2006–2010 American Community Survey (ACS) provide the main data source for analyses in this appendix regarding household income, housing cost burden, and affordability of Seattle's housing supply. There is a considerable lag time between the collection of data and the time HUD publishes the CHAS estimates. The 2006–2010 CHAS estimates were the most recent tabulation of CHAS data available at the time the analysis for this appendix began.

The CHAS data, like other ACS data, do not distinguish whether housing units are income- and rent-restricted. The ACS does not provide official numerical population estimates, but is designed to provide insights into the characteristics of the population.

Other key sources of data reported and analyzed in this appendix include the following.

- *Standard tabulations of decennial Census and American Community Survey (ACS) estimates published by the US Census Bureau;*

- *Rental market data from Dupre+Scott (D+S) Apartment Advisors, Inc. and home sales data from the Northwest Multiple Listing Service (NWMLS);*
- *The City's Office of Planning and Community Development (OPCD) permit database that provides information on recent housing growth;*
- *OPCD's development capacity model, which provides estimates regarding capacity for additional residential growth under current zoning;*
- *Seattle's 2014–2017 Consolidated Plan for Housing and Community Development (Consolidated Plan), and*
- *City Office of Housing (OH) information on rent/income-restricted housing.*

The time periods for the data reported from these sources vary and so do the population, household, and housing unit totals. This is due to several reasons including differences in data release schedules and data availability at the time analysis for this appendix was performed. With some sample-based data sources such as the ACS, data also needed to be pooled over several years in order to report reliable results.

For purposes of the Comprehensive Plan, the City refers to 60 percent of AMI instead of 50 percent of AMI because 60 percent of AMI is a more common income limit for many funding sources for rent/income-restricted housing. However, much of the analysis in this Housing Appendix refers to income levels bounded by 50 percent of AMI (for example, 30–50 percent of AMI, and 50–80 percent of AMI) due to the way key data sources including the CHAS tabulate the AMI income categories.

Housing Needed to Accommodate Growth

The King County Countywide Planning Policies (CPPs) are prepared by the Growth Management Planning Council and ratified by local jurisdictions in the county. The CPPs provide cities in the county with a common set of policies and guidelines for developing local comprehensive plans. The CPPs also facilitate coordinated planning for growth by a collaborative process to allocate expected housing and employment growth to local jurisdictions within the county.

The Washington State Office of Financial Management (OFM) provides forecasts of population growth for each county. (In King County, the population forecast is converted to housing units because local governments can more reliably track housing units on a frequent basis.) In 2010, the CPPs were updated to include twenty-five-year housing and employment growth allocations for all jurisdictions in the county. For Seattle, the twenty-five-year housing growth allocation was 86,000 net new housing units.

Compared with the previous growth estimates, the updated growth estimates in the CPPs reflect greater residential growth rates in the county as a whole as forecast by OFM. The allocation of twenty-year growth estimates was also based on the Puget Sound Regional Council's (PSRC) regional growth strategy, which emphasizes growth in "Metropolitan Cities," including Seattle and Bellevue. The allocation to Seattle was further informed by other factors such as demographic and development trends, zoned capacity, and local policy and market factors.

To correspond with the twenty-year planning period in Seattle's Comprehensive Plan, the City of Seattle translated the twenty-five-year housing and employment growth allocations of 86,000 housing units into a twenty-year growth estimate of 70,000 net new housing units. The housing units needed to satisfy affordability needs for lower-income households are discussed below.

Residential Capacity

OPCD's development capacity model estimates the amount of development that could be accommodated in Seattle. The model is based on current zoning and makes assumptions about likelihood of redevelopment and ultimate development densities achievable in those zones. The City uses development capacity estimates to inform regional and countywide growth planning and to determine potential outcomes of planning efforts conducted for areas of the city.

Housing Appendix Figure A-1 contains residential estimates generated from the development capacity model. This figure shows the amount of residential development capacity for Seattle as a whole. It also shows the capacity in major zoning categories as well as in the city's urban centers and villages.

Seattle's current zoning provides development capacity to accommodate more than 220,000 additional housing units. This capacity is ample for the City's residential growth estimate of 70,000 net new units between 2015 and 2035.

Seattle's mixed-use and residential zones allow a wide range of housing types and densities. About 75 percent of Seattle's residential development capacity is in zones allowing a mix of residential and commercial uses. Of this 75 percent, Commercial, Neighborhood Commercial, and Seattle Mixed zones account for 60 percent of capacity, with Downtown zones accounting for the other 15 percent.

The remaining 25 percent of Seattle's residential development capacity is in zones that allow only residential uses—meaning these zones do not allow a mix of residential and commercial uses. Of this 25 percent, 20 percent is in zones allowing multifamily structures. The remaining 5 percent is in single-family zones.

Thus, Seattle has the zoned capacity for an additional 220,000 units, or about two-thirds the number of housing units that currently exist. This large amount of capacity is consistent with Seattle’s “Metropolitan City” role in the PSRC’s regional growth strategy.

Housing Appendix Figure A-1 also shows capacity estimates for urban centers, hub urban villages, and residential urban villages. More than three-quarters (77 percent) of the capacity for new housing is within urban centers/villages. This shows consistency with the Comprehensive Plan urban village strategy, calling for new development to be concentrated in urban centers/villages, close to transit, other services, and amenities.

About 43 percent of the city’s overall residential development capacity is within urban centers. Of the six urban centers, Downtown has the greatest share of that capacity. Hub urban villages contribute about 16 percent of Seattle’s total residential development capacity, and residential urban villages contribute about 18 percent.

Housing Appendix Figure A-1
Seattle Residential Development Capacity (Model Estimates)

	Residential Development Capacity (Housing Units)	Share of Total Residential Development Capacity
TOTAL	223,713	100%
By Future Land Use Designation:		
Single-Family	10,959	5%
Multifamily	46,803	21%
Commercial/Mixed-Use	132,439	59%
Downtown	33,512	15%
Major Institution	N/A	N/A
City-Owned Open Space	0	0%
By Urban Centers/Villages:		
Inside Urban Centers	96,862	43%
Downtown	33,512	15%
First Hill/Capitol Hill	19,009	8%
Northgate	10,966	5%
South Lake Union	20,277	9%

	Residential Development Capacity (Housing Units)	Share of Total Residential Development Capacity
Uptown	4,165	2%
University District	8,933	4%
Inside Hub Urban Villages	36,227	16%
Inside Residential Urban Villages	39,386	18%
Outside Centers and Villages	51,207	23%

Source: Development Capacity Report, DPD, September 2014

Broad Trends in Seattle's Population and Households

This section summarizes recent trends in the basic characteristics of Seattle's population and households, using estimates from the 2000 and 2010 censuses and the most recent three-year tabulation of ACS data spanning 2011 to 2013.¹ This is the most recent set of ACS multiyear estimates since the 2010 Census. This summary provides broad context for the more detailed analysis of household characteristics and housing needs discussed below.

Seattle has the largest population of cities in the state of Washington and is the twenty-third most populous city in the US. The 2010 Census counted Seattle's population at 608,660. From 2000 to 2010, Seattle's population grew by 8 percent.

Seattle has seen substantial growth in population, households, and housing units since the 2010 Census. OFM produces official population estimates for cities and counties on an annual basis. As of April 2015, OFM estimates that Seattle contained approximately 662,400 residents, 314,326 households, and 332,694 housing units.

Population Characteristics

The 2010 Census results showed that more than a third (33.7 percent) of Seattle residents are people of color, up from 32.1 percent in 2000.² ACS estimates for the period 2011 to 2013 indicate that the number and share of Seattle's residents who are people of color has continued to increase since 2010. However, these ACS estimates show that the increase in the population of color has occurred much more slowly in Seattle than in the balance of King County. **(See Housing Appendix Figure A-2.)**

1. The analysis uses the 2011–2013 ACS estimates because they are the most recent multiyear estimates available spanning the years after the 2010 census.
2. The Census collects information on Hispanic/Latino ethnicity in a separate question from race. "People of color" encompass Hispanics and Latinos of any race as well as people who are any race other than white alone.

Although the population of color in the city as a whole increased between 2000 and 2010, the population of color declined in many of the census tracts located in the central and southeast portions of Seattle.

The 2010 Census indicates that children under eighteen make up roughly 15 percent of the city’s population. Between 2000 and 2010, the number of children in Seattle increased, but at a slightly slower pace than the overall population increased. However, the number of young children (under age five) increased much more quickly.

Families with children are substantially underrepresented in Seattle compared with the balance of King County. Data indicate that this is starting to change, but trends differ greatly by race. Increases in Seattle’s population of children have mainly been from the growing numbers of white, non-Hispanic children living in the city. In the balance of King County, increases in the child population have, in contrast, been driven by a rapid rise in the number of children of color.

Housing Appendix Figure A-2

Growth in Total Population and Population Under 18
(Includes Detail for the Population of Color and for the White, Non-Hispanic Population)

	Population Growth in Seattle				Pop. Growth in Remainder of King Co.			
	2000-2010 Census		2010 to 2011-2013 ACS		2000-2010 Census		2010 to 2011-2013 ACS	
Total population	45,286	8.0%	27,610	4.5%	148,929	12.7%	48,920	3.7%
Pop. of color	24,240	13.4%	11,152	5.4%	193,802	69.0%	40,009	8.4%
White, non-Hispanic pop.	21,046	5.5%	16,458	4.1%	-44,873	-5.0%	8,911	1.1%
Pop. under 18 yrs. of age	5,686	6.5%	6,917	7.4%	17,170	5.7%	4,723	1.5%
Pop. of color under 18	896	2.1%	1,399	3.2%	59,062	63.8%	10,150	6.7%
White, non-Hispanic pop. under 18	4,790	10.7%	5,518	11.2%	-41,892	-19.9%	-5,427	-3.2%

Sources: 2000 Census and 2010 Census estimates; 2011-2013 ACS estimates.

Census estimates show that young adults (i.e., adults between eighteen and thirty-four years of age) make up a large share of Seattle’s population. In 2010, young adults were 33 percent of Seattle’s population compared to 22 percent in the remainder of King County.

The 2010 Census found that seniors (people age sixty-five and over) are about 11 percent of Seattle’s population. The number of seniors in Seattle, as well as the percentage share of

the city's population who are seniors, declined between 2000 and 2010. However, ACS estimates for the period 2011 to 2013 suggest that the number of seniors in the city is starting to increase as individuals in the baby boom generation begin reaching their senior years.

Household Characteristics

The 2010 Census tallied 283,510 households in Seattle. This was an increase of roughly 25,000 households, or 9.7 percent, since the 2000 Census.

Between 2000 and 2010, the average number of people per household in Seattle declined from 2.08 to 2.06. This slight decline reflects the continuation, but marked slowing, of a long-term trend toward smaller household sizes locally and nationally.³

Census 2010 found that about 43 percent of households in Seattle are family households, less than half of which are families with children. About 19 percent of Seattle's households are families with related children.⁴ The majority (57 percent) of Seattle's households is non-family households, and most of these non-family households are people living alone. In 2010, one-person households made up 41 percent of Seattle's total households. The increasing number of one-person households has been a key driver contributing to the broader decline in the city's household size.

In Seattle, renter households outnumber households who own their home. Of Seattle households counted in Census 2010, 52 percent were renter households and 48 percent were owner households. The trend in recent decades has been one of gradually declining homeownership rates and increasing shares of renter households.⁵ The ACS (2011–2013) estimates show that approximately 54 percent of Seattle's households rent, continuing a long-term increase in the share of Seattle households who rent. The share of households in Seattle who are renters is likely to increase as multifamily housing units (which are more commonly renter-occupied than owner-occupied) continue to increase as a share of the city's housing stock.

-
3. The 2011 to 2013 ACS shows an average household size in Seattle of about 2.12 people, which is higher than the household size in 2010. That recent increase in Seattle's household size reflects a decrease in the rate of household formation that occurred in the US as a whole in the wake of the Great Recession. It is likely that the increase in household size will be temporary.
 4. These figures on family households with children refer to households in which there is at least one child under eighteen years of age who is related to the householder.
 5. Single-year ACS estimates indicate that the downward trend in homeownership rates was interrupted temporarily during the housing bubble that occurred in the latter half of the last decade. However, estimated homeownership rates in the city began to decline again after the effects of the Great Recession took hold.

Population in Group Quarters

The 2010 Census found that one in twenty Seattle residents lived in group quarters such as college/university student housing (with about 11,800 people), nursing facilities (2,600 people), and correctional facilities (2,000 people).

Analysis of Key Household Characteristics

The analysis provided below is based on CHAS data from ACS surveys (2006–2010) reflecting approximately 280,470 total households in Seattle. The household total from the CHAS is lower than the number of households who currently reside in Seattle. Today, Seattle contains almost 315,000 households.⁶

Tenure refers to whether a household owns or rents the housing unit in which they live. As indicated in Housing Appendix Figure A-3, approximately 51 percent of households in the 2006–2010 CHAS estimates are renters. It is important to view these estimates in the context of the period in which they were collected. The 2006–2010 CHAS estimates include the housing boom in the mid-2000s, the Great Recession, and the steep downturn in the housing market in the wake of that recession. As noted above, the share of Seattle households who rent is now closer to 54 percent.

Housing Appendix Figure A-3

Total Households and Household by Tenure, Seattle

Total households	280,470	100.0%
Owner households	137,090	48.9%
Renter households	143,380	51.1%

Source: CHAS (2006–2010)

Income Distribution

There is a wide distribution of incomes among Seattle households as shown in the pie chart in Housing Appendix Figure A-4.

6. The previous section of the appendix summarizes more recent data available from other sources. OFM estimates that Seattle contained 314,326 households as of April 2015.

- Households with incomes at or below 80 percent of area median income (AMI) comprise almost 40 percent of total households in Seattle.
- About 26 percent of all Seattle households have incomes at or below 50 percent of AMI.
- Households with incomes above 80 percent of AMI but not higher than 120 percent of AMI are about 18 percent of Seattle households.
- Roughly 42 percent of households in Seattle have incomes above 120 percent of AMI.

Housing Appendix Figure A-4

Seattle Households (HHs) by Household Income Category

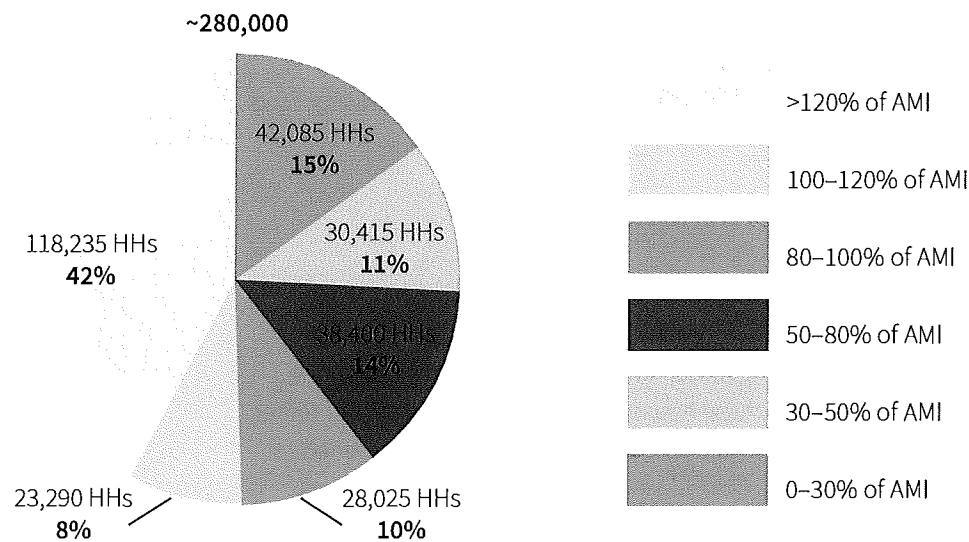

Source: CHAS (2006-2010)

The distribution of household incomes varies a great deal by tenure. Compared with owner households, renter households are much more likely to have incomes lower than 80 percent of AMI. A majority of renter households, but only about one in five owner households, are in lower income categories. About 40 percent of renter households have incomes of no higher than 50 percent of AMI, in contrast with an 11 percent share of owner households.

Households with Unaffordable Housing Cost Burdens

A broadly used standard for housing affordability regards housing costs that consume up to and including 30 percent of a household's income to be affordable. This standard evolved as a general indicator of the share of income that a household can spend on housing

and still have enough income left over for other essentials such as food, clothing, and transportation.

Based on the 30 percent standard, HUD considers households to be cost-burdened if they spend more than 30 percent of their household income on housing costs and severely cost-burdened if they spend more than 50 percent of their household income on housing costs. (This appendix refers to households as “moderately” cost-burdened if the households spend more than 30 percent but not more than 50 percent of their income on housing.)

Based on the CHAS data, approximately 38 percent of all households in Seattle are cost-burdened at either a moderate or a severe level. About 21 percent of all Seattle households are “moderately” cost-burdened. Approximately 17 percent of all Seattle households are severely cost-burdened.

Cost Burdens by Tenure and Household Income

Renter households are more likely than owner households to be burdened by housing costs they cannot afford.

- *About 42 percent of renter households are cost-burdened.*
- *A lower, but still sizable, 33 percent share of owner households is cost-burdened.*

The greater prevalence of cost burdens among renter households is primarily due to the higher prevalence of severe burdens among these households: roughly 21 percent of renter households, compared to 13 percent of owner households, are severely cost-burdened.

Housing Appendix Figure A-5 shows that more than three-quarters of households in both the 0–30 percent of AMI and 30–50 percent of AMI categories spend more than 30 percent of income on housing and that more than 60 percent of households with incomes of 0–30 percent of AMI spend more than half of their income on housing.

Housing Appendix Figure A-5

Seattle Households (by Income Category) Who Are Moderately or Severely Housing Cost-Burdened

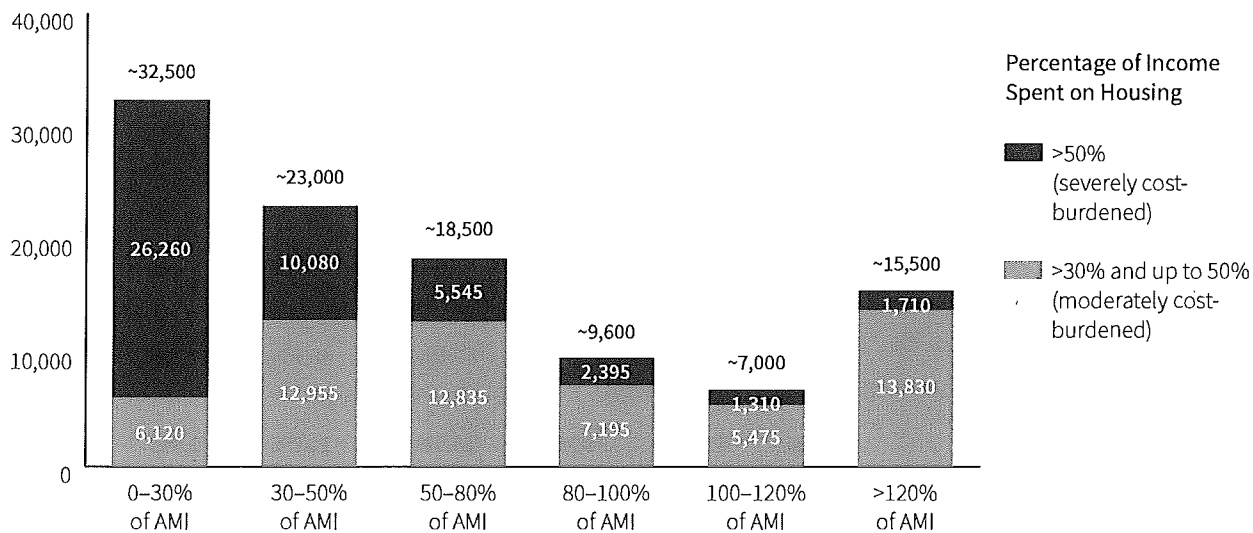

Source: 2006–2010 5-Year Estimates from the American Community Survey CHAS Dataset.

Housing Appendix Figure A-6 provides additional detail on the prevalence of cost burdens by tenure and household income category.

Housing Appendix Figure A-6

Housing Costs as a Percentage of Household (HH) Income
(Includes Detail by Tenure and Income Category)

	0-30% of AMI	30-50% of AMI	50-80% of AMI	80-100% of AMI	100-120% of AMI	>120% of AMI	TOTAL
Est. number of owner HH with housing costs:	7,265	8,400	12,585	11,390	11,580	85,855	137,090
up to 30% of HH income (not cost-burdened)	780	2,830	5,130	5,355	6,150	71,165	91,420
not computed (no/negative income)	570	-	-	-	-	-	570
>30% of HH income (total cost-burdened)	5,915	5,570	7,455	6,035	5,430	14,690	45,100

	0-30% of AMI	30-50% of AMI	50-80% of AMI	80-100% of AMI	100-120% of AMI	>120% of AMI	TOTAL
>50% of HH income (severely cost-burdened)	4,865	3,840	3,795	2,055	1,270	1,600	17,425
30-50% of HH income (moderately cost-burdened)	1,050	1,730	3,660	3,980	4,160	13,090	27,675
Est. percent of owner HH with housing costs:							
up to 30% of HH income (not cost-burdened)	10.7%	33.7%	40.8%	47.0%	53.1%	82.9%	66.7%
not computed (no/negative income)	7.8%	0.0%	0.0%	0.0%	0.0%	0.0%	0.4%
>30% of HH income (total cost-burdened)	81.4%	66.3%	59.2%	53.0%	46.9%	17.1%	32.9%
>50% of HH income (severely cost-burdened)	67.0%	45.7%	30.2%	18.0%	11.0%	1.9%	12.7%
30-50% of HH income (moderately cost-burdened)	14.5%	20.6%	29.1%	34.9%	35.9%	15.2%	20.2%
Est. number of renter HH with housing costs:	34,820	22,015	25,815	16,635	11,710	32,380	143,380
up to 30% of HH income (not cost-burdened)	6,000	4,550	14,890	13,080	10,355	31,530	80,410
not computed (no/negative income)	2,355	-	-	-	-	-	2,360
>30% of HH income (total cost-burdened)	26,465	17,465	10,925	3,555	1,355	850	60,610
>50% of HH income (severely cost-burdened)	21,395	6,240	1,750	340	40	110	29,875
30-50% of HH income (moderately cost-burdened)	5,070	11,225	9,175	3,215	1,315	740	30,735
Est. percent of renter HH with housing costs:							
up to 30% of HH income (not cost-burdened)	17.2%	20.7%	57.7%	78.6%	88.4%	97.4%	56.1%
not computed (no/negative income)	6.8%	0.0%	0.0%	0.0%	0.0%	0.0%	1.6%
>30% of HH income (total cost-burdened)	76.0%	79.3%	42.3%	21.4%	11.6%	2.6%	42.3%

	0–30% of AMI	30–50% of AMI	50–80% of AMI	80–100% of AMI	100–120% of AMI	>120% of AMI	TOTAL
>50% of HH income (severely cost-burdened)	61.4%	28.3%	6.8%	2.0%	0.3%	0.3%	20.8%
30–50% of HH income (moderately cost-burdened)	14.6%	51.0%	35.5%	19.3%	11.2%	2.3%	21.4%

Source: CHAS (2006–2010)

Household Characteristics by Race and Ethnicity

Shortly after taking office, Mayor Murray issued Executive Order 2014–02 to reaffirm and further detail the City’s commitment to RSJI, meaning that the City will incorporate a racial equity lens in citywide initiatives including those related to affordable housing and planning for equitable growth and development.

Data are presented in the following pages to identify the extent of disparities in housing needs and opportunities by race and ethnicity. Consideration of these disparities is vital to informing planning for housing consistent with RSJI.

Tenure by Race and Ethnicity

While a slight majority (53 percent) of white, non-Hispanic households own their homes, most households of color⁷ (63 percent) are renters. The share of Asian households who rent is only slightly more than half, but renting is much more prevalent for households in which the householder is Hispanic or Latino, Native American, Pacific Islander, or black or African American. More than two-thirds of each of these groups of households rent.

Household Income Distribution by Race and Ethnicity

Seattle’s households of color are disproportionately likely to have incomes that are under 50 percent of AMI, a pattern that applies not only to households of color overall, but also to each of the individual racial and ethnic groups of color for which the CHAS data are tabulated.

- *Households of color as a group are twice as likely as white, non-Hispanic households to have a household income that is 0–30 percent of AMI: about 24 percent of households of*

7. Households of color are households in which the householder is a person of color. The Census Bureau tabulates race and ethnicity of households based on the characteristics of the householder. For convenience, this Appendix refers sometimes refers to households by race or ethnicity, but this is not intended to imply that all household members are of the same race or ethnicity as the householder.

color compared to 12 percent of white, non-Hispanic households have incomes this low. Furthermore, about 16 percent of households of color compared to 13 percent of white, non-Hispanic households have incomes that are 30–50 percent of AMI.

- Over half of black households have incomes no higher than 50 percent of AMI. Breaking down these data further, about 35 percent of black households have incomes no higher than 30 percent of AMI, and 17 percent have incomes from 30 to 50 percent of AMI.
- Having an income at or below 50 percent of AMI is almost as common for Native American households and Pacific Islander households as it is for black households: over 40 percent of households in each of these groups have incomes at or below 50 percent of AMI.

Racial and ethnic disparities in income levels exist for both renters and owners as detailed in Housing Appendix Figure A-7 for many Seattle racial and ethnic groups.

Housing Appendix Figure A-7

Household (HH) Income Distribution by Race and Ethnicity of Householder by Tenure, Seattle

	Broad Categories			Specific Racial and Ethnic Groups of Color			Totals
	White alone, not Hispanic	Of color	Asian alone, not Hispanic	Black or African American	Other (incl. Native American, Pacific Islander, and multiple race)	Hispanic or Latinx, any race	
Total Owner Households	109,100	28,015	14,995	5,900	3,870	3,250	137,115
Owner Household Income—Percent of AMI							
less than or equal to 30%	5%	7%	6%	12%	6%	4%	5%
greater than 30% but less than or equal to 50%	6%	9%	7%	12%	6%	11%	6%
greater than 50% but less than or equal to 80%	8%	13%	14%	15%	9%	10%	9%
greater than 80% but less than or equal to 100%	8%	11%	11%	12%	10%	8%	8%
greater than 100%	74%	61%	62%	49%	68%	67%	71%
Percent of AMI—Cumulative							
less than or equal to 50%	10%	15%	13%	24%	13%	15%	11%

	Broad Categories			Specific Racial and Ethnic Groups of Color			
	White alone, not Hispanic	Of color	Asian alone, not Hispanic	Black or African-American	Other (incl. Native American, Pacific Islander, and multiple race)	Hispanic or Latino, any race	Total
less than or equal to 80%	19%	29%	27%	39%	22%	25%	21%
Total Renter Households	95,575	47,785	16,975	13,390	7,570	9,850	143,360
Renter Household Income—Percent of AMI							
less than or equal to 30%	19%	34%	36%	45%	25%	23%	15%
greater than 30% but less than or equal to 50%	14%	18%	16%	19%	18%	18%	18%
greater than 50% but less than or equal to 80%	18%	17%	16%	14%	22%	21%	12%
greater than 80% but less than or equal to 100%	13%	9%	8%	7%	12%	13%	31%
greater than 100%	36%	21%	23%	15%	23%	24%	24%
Percent of AMI—Cumulative							
less than or equal to 50%	33%	52%	53%	65%	42%	42%	33%
less than or equal to 80%	52%	70%	69%	79%	65%	63%	45%

Source: CHAS 2006–2010. Notes: Households of color have a householder who is of Hispanic origin or a race other than white alone. Native American and Pacific Islander households are included in the “other” category due to the small survey sample sizes at this level of detail.

Prevalence of Housing Cost Burdens by Race and Ethnicity

Unaffordable housing cost burdens fall disproportionately on households of color. Overall, as shown in Housing Appendix Figure A-8, about 44 percent of households of color are moderately or severely cost-burdened compared with 35 percent of white, non-Hispanic households. About 22 percent of householders of color are severely cost-burdened, compared to roughly 15 percent of white, non-Hispanic households.

Among most racial and ethnic groups analyzed, cost burdens are more common for renter households than for owner households. However, data for Hispanic or Latino households suggest a possible exception to this pattern.

Housing Appendix Figure A-8

Shares of Seattle Households, by Race of Householder, Who Are Moderately or Severely Housing Cost-Burdened

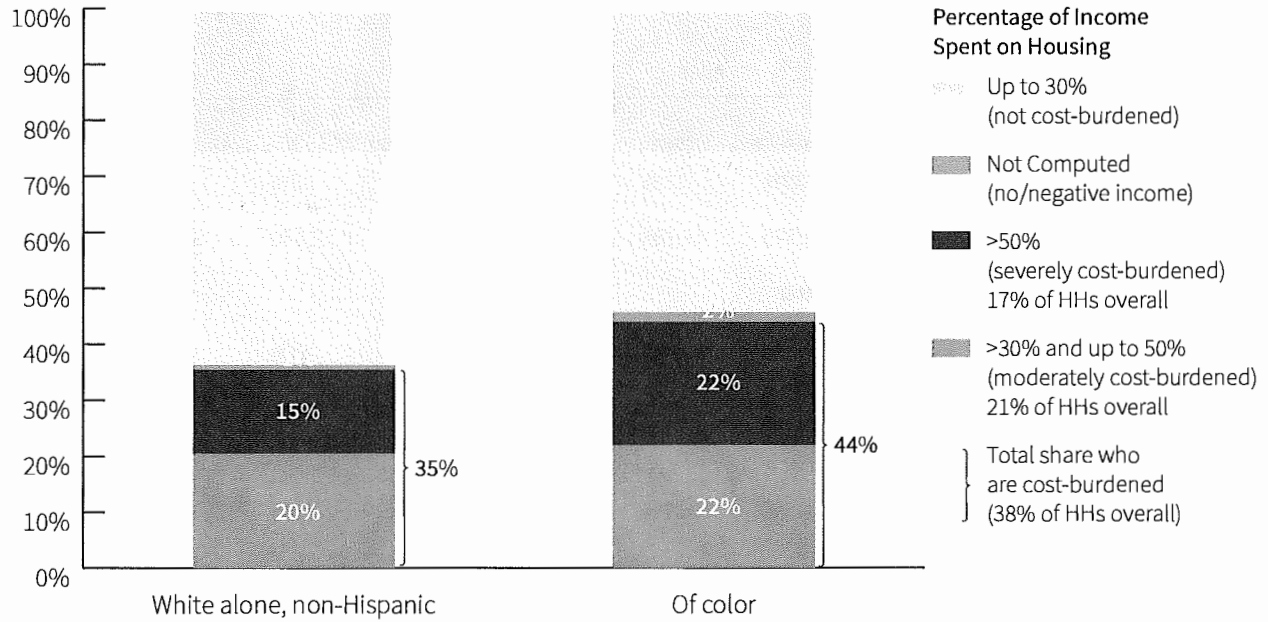

Source: 2006–2010 5-Year Estimates from the American Community Survey CHAS Dataset.

Overall, about 47 percent of renter households of color are burdened by unaffordable housing costs compared with 40 percent of white, non-Hispanic renter households.

Housing Appendix Figure A-9 illustrates this finding and provides additional detail on how rates of cost burden vary among renter households by race and ethnicity.

Housing Appendix Figure A-9

Shares of Seattle Renter Households (by Race of Householder)
Who Are Moderately or Severely Housing Cost-Burdened

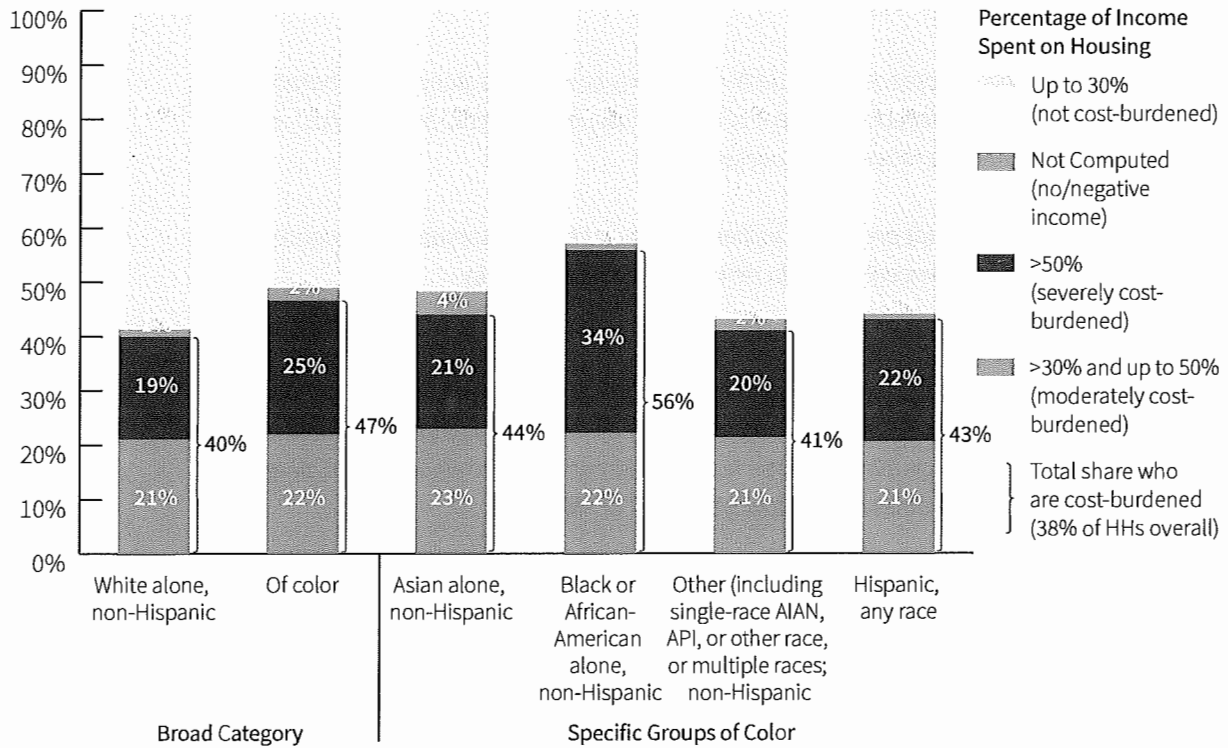

Source: 2006–2010 5-Year Estimates from the American Community Survey CHAS Dataset.

Prevalence of Housing Cost Burden by Household Type

The CHAS (2006–2010) tabulations include income and prevalence of cost burden for five household types^{8,9}. This data is also broken out by tenure (Housing Appendix Figure A-10). Insights for Seattle are summarized below.

- *Renter households comprised of elderly non-family households stand out as particularly likely to be cost-burdened: 54 percent of these households are cost-burdened compared to 42 percent of renter households overall.*
- *Renter households that are large families also have a higher estimated prevalence of cost burden (roughly 47 percent) than do renter households generally.*
- *The higher prevalence of cost burdens found among elderly non-family households and large families correlates with the fact that these households are also disproportionately likely to have very low-incomes: 64 percent of elderly non-family renter households, and 57 percent of large families renter households, compared to 40 percent of all renter households, have incomes at or below 50 percent of AMI.*
- *Within the category of owner households, elderly non-family households are also one of the household types most likely to be cost-burdened.¹⁰ About 39 percent of elderly non-family owner households are cost-burdened, compared to 33 percent of owner households overall. Elderly non-family households are much more likely than owners generally to have a household income no higher than 50 percent of AMI (37 percent of elderly non-family households have incomes this low compared to only 11 percent of owner households overall).*

-
8. The five household types tabulated in CHAS (2006–2010) data are as follows.
- Elderly family households, which are defined as families of two people, with either or both age sixty-two or over.
 - Elderly non-family households, which are one- or two-person non-family households in which either person is sixty-two years or over. The CHAS data do not include more detail on the composition of these households, but other ACS tables suggest that a large majority of these households are elderly women living alone.
 - Small family households, defined as families comprised of two people, neither of which is sixty-two years or over, or three or four people.
 - Large family households, which are families with five or more people.
 - Other household types, referred to in this appendix as non-elderly, non-family. This includes non-elderly people living alone and most other households with non-related individuals who are not elderly.
9. Disability questions on the ACS were changed between 2007 and 2008, which rendered the previous data on disability noncomparable after the change. Consequently, estimates for households with disabled people are not available in the CHAS (2006–2010) tabulations.
10. Non-elderly, non-family households are the other type of owner household disproportionately likely to be cost-burdened. However, they are no more likely than other owner households to have incomes at or below 50 percent of AMI.

Housing Appendix Figure A-10

Percentage share of cost-burdened households by household type, Seattle

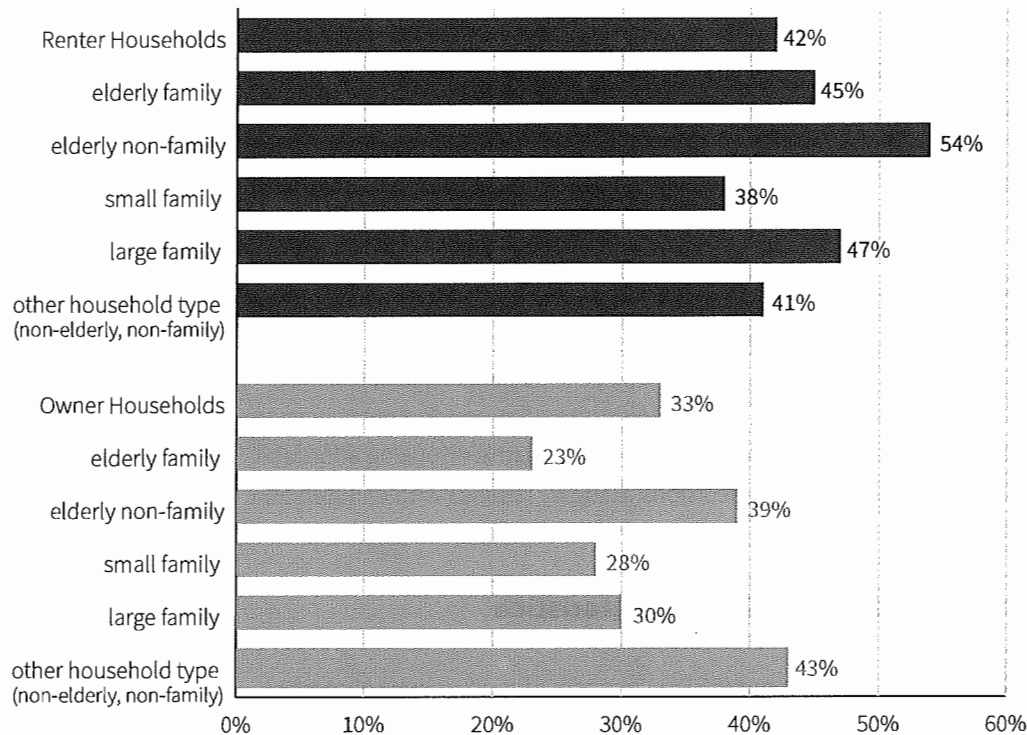

Source: CHAS (2006–2010)

Another way to look at cost burden data besides percentages is in terms of absolute numbers of cost-burdened households. The largest estimated numbers of cost-burdened households are found for: 1) non-elderly, non-family households and 2) small family households. These two types of households are also the overall most common household types in Seattle.

Another essential observation is that sizable majorities of households in the lowest income categories are cost-burdened *regardless* of household type. This is, for example, the case for small family households in the lowest income categories.

The CHAS data tabulate cost burden for generalized household types. This limits the insights that can be derived from the CHAS data. Notably, the CHAS tables do not capture whether family households include children. Single-parent households, which are among the most economically disadvantaged households, are also not distinguished in the CHAS data.

A separate and earlier analysis for an earlier Consolidated Plan (2009–2012) used ACS (2006) microdata to identify the characteristics of households who were more likely to be severely

cost-burdened. That analysis included some household categories not isolated in the CHAS tabulations and found that households in which there was a female single parent, and households composed of a family with two or more children, were among the groups of renter households disproportionately likely to be shouldering severe housing cost burdens.

Household cost burdens are a key indicator of affordability problems within a community but must be considered in context of other housing data and in light of broader regional demographics. Cost burden data provided for Seattle households only refer to those households living *within* the city and are blind to the housing needs of households who may wish to live in Seattle, but have located outside of the city of Seattle likely due to affordability considerations.

For example, family households with children are a demographic substantially underrepresented in Seattle relative to the region. As previously noted, the population of color under eighteen in Seattle is increasing much more slowly than this population segment is increasing in the remainder of King County. These factors suggest that Seattle’s housing affordability challenges may be affecting the locational decisions made by families with children and families of color.

Maps Showing Selected Household Characteristics

HUD’s Community Planning and Development (CPD) Office provides an online set of mapping tools for analyzing housing needs at the local and neighborhood level. Screenshots of selected CPD maps for census tracts in and around Seattle are included in several sections of this appendix. Maps showing household income and cost burden are in the subsections that follow immediately below, while maps about the affordability of the housing supply are included in Section G—Affordability of Seattle’s Overall Housing Supply.

The shading for the CPD maps in this appendix was generated using the default “natural breaks” setting for highlighting variation within a region. The resulting data ranges are different from one map to the other and are shown in the legend accompanying each map.

The CPD maps are based on the CHAS data collected from 2007 to 2011, which is a slightly later period than the period for other CHAS data analyzed in this appendix.¹¹

Shares of Households by Income Category by Census Tract

The trio of maps (Housing Appendix Figures A-11, A-12, and A-13) that follow show estimated shares of households within each census tract with incomes equal to or below three AMI-based income thresholds: 30 percent of AMI, 50 percent of AMI, and 80 percent of AMI.

11. The interactive CPD mapping tool is online at <http://egis.hud.gov/cpdmaps/>. More information about the tool and the data that populate the maps is available in the *CPD Maps Desk Guide*.

These maps reveal a great deal of variation between census tracts. In Seattle, the census tracts with the largest shares of lower-income households (meaning at or below 80 percent of AMI) tend to be in and around Seattle's Downtown, the University District, in Delridge, and along Rainier Valley. A similar pattern applies to neighborhoods to the south, and slightly southeast, of Seattle's city limits, where more than half of the households in many census tracts are lower income (at or below 80 percent of AMI).

There are also some census tracts in North Seattle where relatively large shares of households are lower income (at or below 80 percent of AMI), i.e., in the Broadview/Bitter Lake area and in a grouping of tracts running from the Aurora-Licton Springs neighborhood through Northgate and into Lake City.

Census tracts where substantial shares of households have incomes no higher than 30 percent of AMI are smaller in number and found in more distinct concentrations in and around Seattle compared to the more diffuse patterns described above.

Prevalence of Housing Cost Burdens by Census Tract

Housing Appendix Figure A-14 shows the estimated percentages of households in each census tract with housing costs that are more than 30 percent of their income. Not surprisingly, high percentages of cost-burdened households are found in many of the census tracts where there are large shares of lower-income households.

Housing Appendix Figure A-11

Share of Households with Income at or Below 30 Percent of AMI

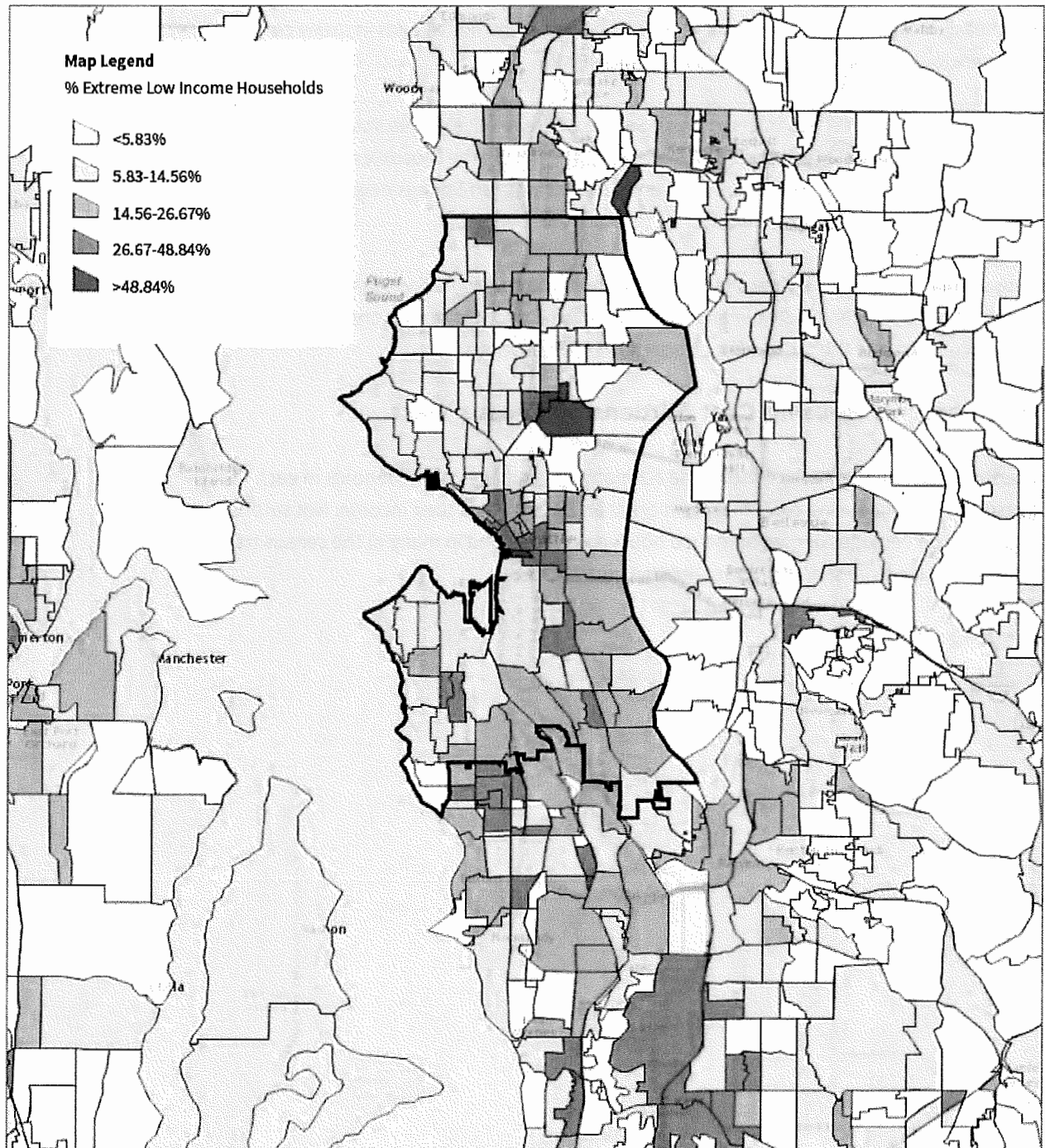

Source: CHAS (2007-2011)

Housing Appendix Figure A-12

Share of Households with Income at or Below 50 Percent of AMI

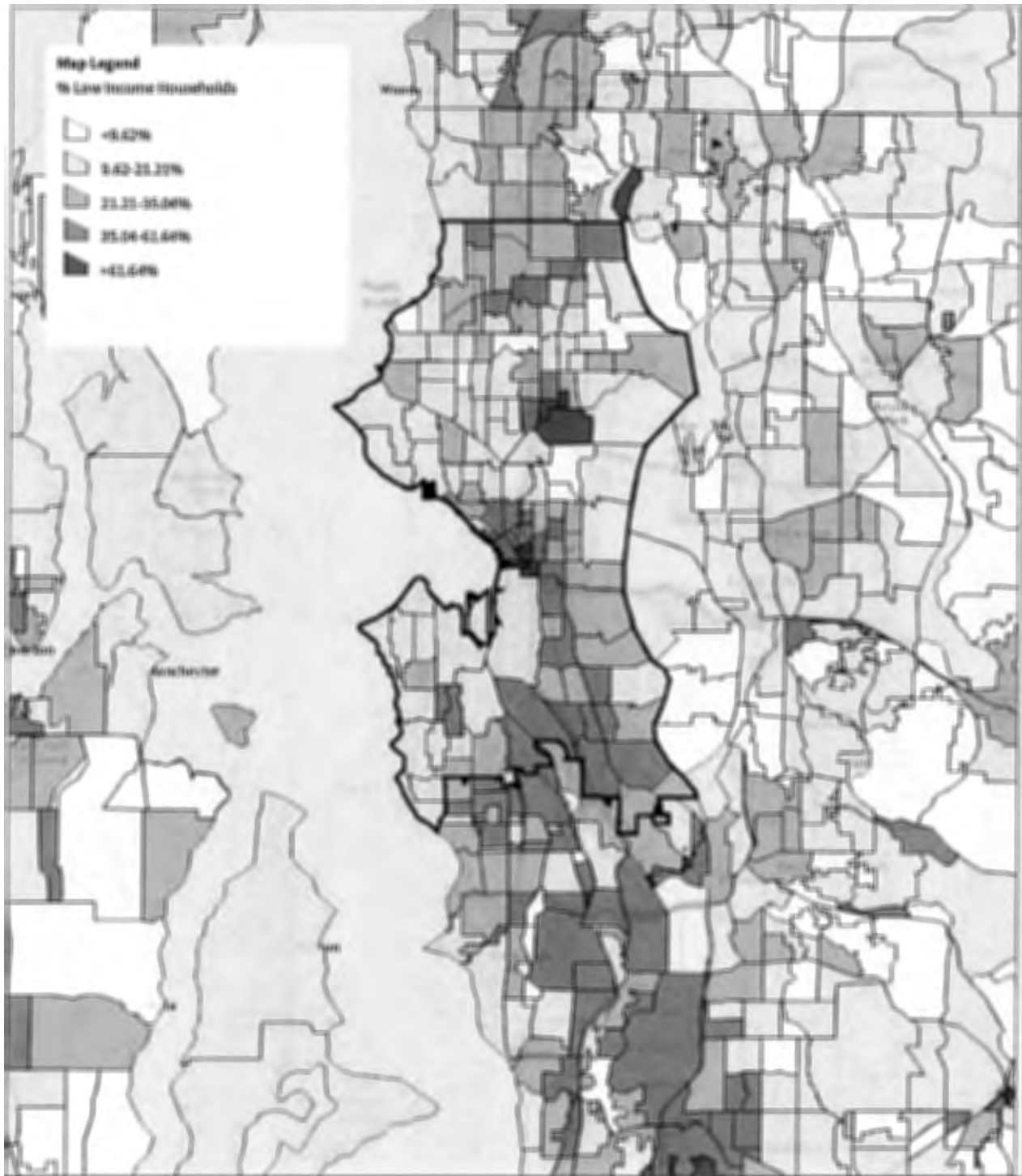

Source: CHAS (2007-2011)

Housing Appendix Figure A-13

Share of Households with Income at or Below 80 Percent of AMI

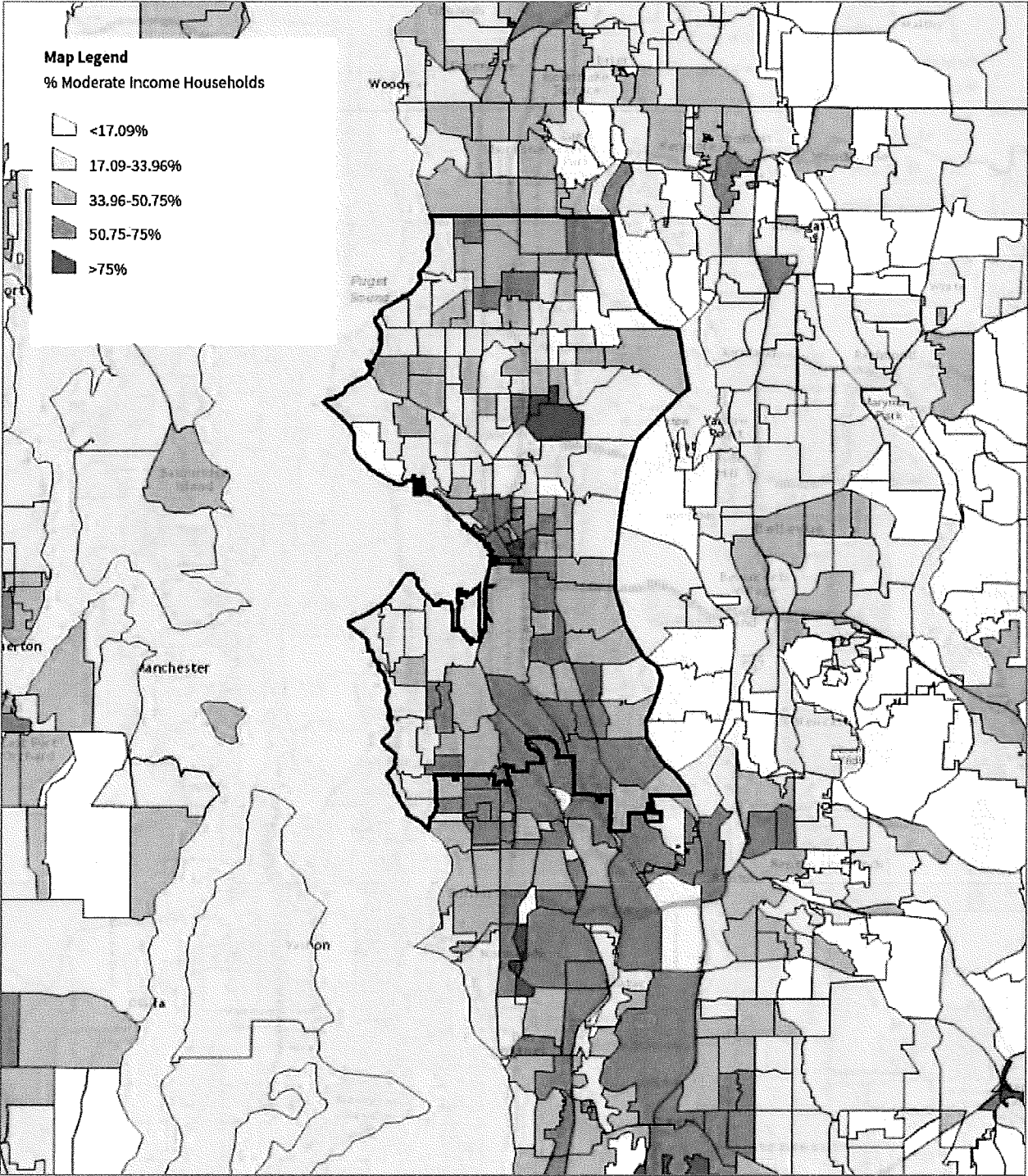

Source: CHAS (2007-2011)

Housing Appendix Figure A-14

Share of Households with Housing Cost Burden

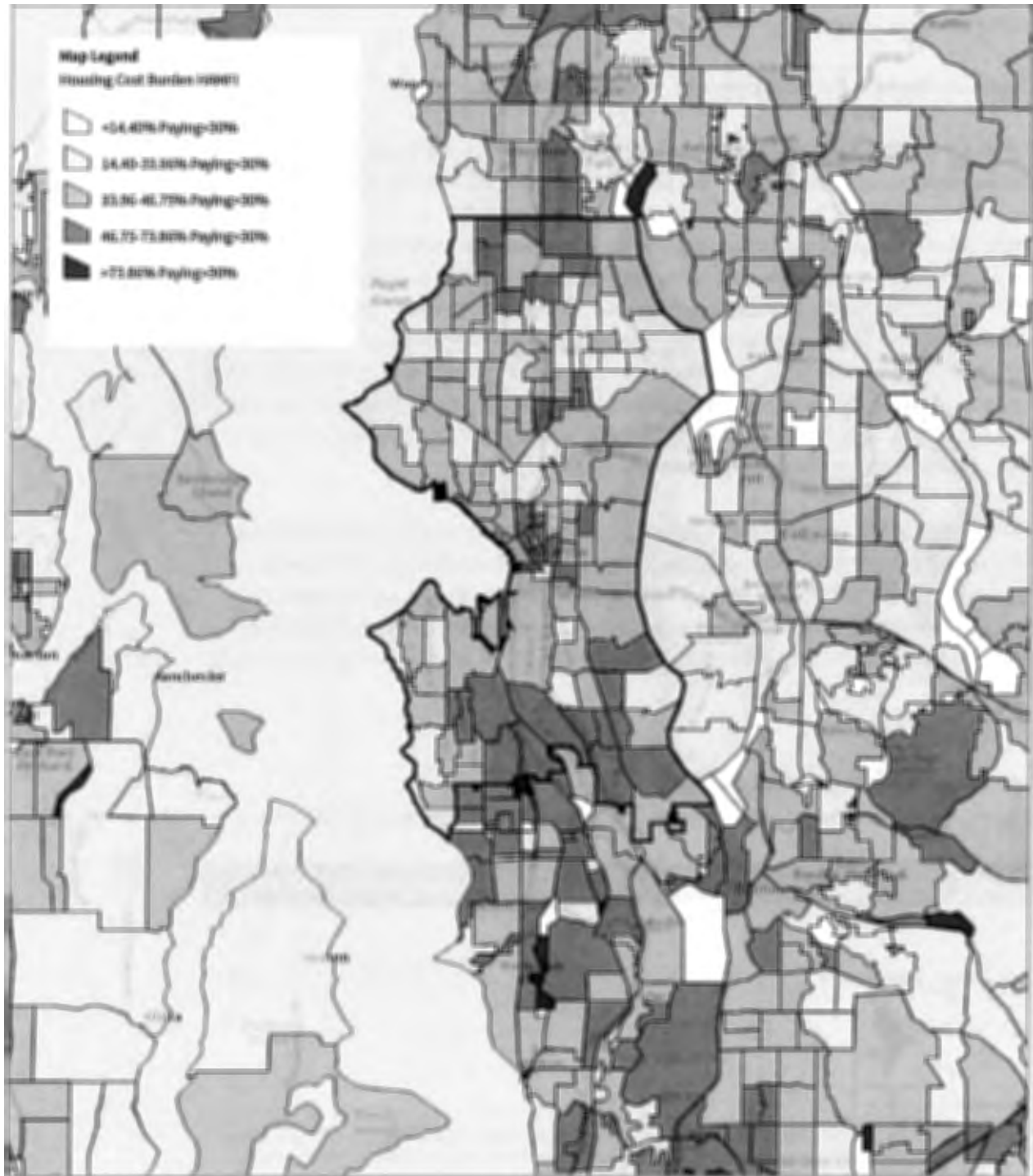

Source: CHAS (2007-2011)

Special Needs Populations

The GMA and the CPPs direct cities to address special-needs populations in their Comprehensive Plan housing needs analyses.¹²

Special-Needs Populations in Group Quarters

The decennial Census includes a tabulation of the population residing in group quarters. For example, the 2010 Census enumerated 24,925 people living in group quarters in Seattle.

Many group quarters categories are devoted to serving, or mostly serve, people who can be broadly regarded as special-needs populations. Housing Appendix Figure A-15 shows 2010 Census data for the subset of group quarters categories that have a primary function of serving special-needs populations. Figure A-15 shows the population in this subset to be almost 10,400 people, or about 40 percent of all people living in group quarters. About 2,800 of these 10,400 people were counted in institutional facilities, primarily in nursing facilities, and about 7,600 were counted in noninstitutional facilities. Seniors age sixty-five and over were a large majority of the nursing facilities population.

Emergency and transitional shelters were the largest noninstitutional category (2,550 people). A 2010 Census Special Report on the Emergency and Transitional Shelter Population found that Seattle had the seventh largest emergency and transitional shelter populations among places in the US with a population of 100,000 or more. The Census counted 2,900 people under “other noninstitutional facilities.” A large proportion of this population may be homeless.

Housing Appendix Figure A-15

Population in Categories of Group Quarters Associated with Special Needs (2010 Census)

Group Quarters Categories	Estimated Seattle Population
Total	10,371
Institutionalized people	2,823
Juvenile facilities	115

12. PSRC’s Housing Element Guide (July 2014) indicates that special-needs housing “refers broadly to housing accommodations for individuals with physical and mental disabilities, seniors, veterans, individuals with mental illness, individuals with chronic and acute medical conditions, individuals with chemical dependency, survivors of domestic violence, and adult, youth, and families who are homeless.”

Group Quarters Categories	Estimated Seattle Population
Group homes for juveniles (noncorrectional)	58
Residential treatment centers for juveniles (noncorrectional)	57
Nursing facilities/Skilled-nursing facilities	2,588
Other institutional facilities	120
Mental (psychiatric) hospitals and psychiatric units in other hospitals	53
Hospitals with patients who have no usual home elsewhere	2
In-patient hospice facilities	65
Noninstitutionalized people:	7,548
Emergency and transitional shelters (with sleeping facilities) for homeless people	2,550
Group homes intended for adults	1,387
Residential treatment centers for adults	637
Workers' group living quarters & Job Corps centers	70
Other noninstitutional facilities:	
<ul style="list-style-type: none"> • Soup kitchens • Regularly scheduled mobile food vans • Targeted nonsheltered outdoor locations • Living quarters for victims of natural disaster • Religious group quarters • Domestic violence shelters 	2,904

Source: 2010 Census

Homeless People from One Night Count and Agency Data

One night each January a count of homeless people is conducted at locations in Seattle and elsewhere in King County to identify the extent and nature of homelessness. The One Night Count has two components: a count of unsheltered homeless, which is conducted by the Seattle/King County Coalition on Homelessness, and a count (by agency staff) of people being served that same night in emergency shelters and transitional housing programs. Agency staff also collect information about those people being served.

Unsheltered Homeless

Housing Appendix Figure A-16 summarizes the gender, age, and location of unsheltered homeless people counted during the January 2016 One Night Count in locations within

Seattle and in King County as a whole. During the three-hour January 2016 street count 4,505 men, women, and children were found without shelter. This is an increase of 19 percent over those found without shelter in January of the previous year. The Seattle/King County Coalition on Homelessness notes that One Night Count estimates are assumed to be an undercount, because volunteers do not count everywhere, and because many unsheltered homeless people try not to be visible. Sixty-five percent of the more than 4,500 unsheltered homeless people counted in King County were in Seattle.

Housing Appendix Figure A-16

One Night Count: Unsheltered Homeless People (January 2016)

	Seattle	King County as a Whole
Total	2,942	4,505
Age and gender		
Men	827	1,225
Women	153	271
Gender unknown	1,951	2,980
Minor (under 18)	11	29
Location		
Benches	46	57
Parking garages	26	54
Cars/trucks	914	1,608
Structures	533	653
Under roadways	257	290
Doorways	271	297
City parks	24	66
Bushes/undergrowth	37	153
Bus stops	29	64
Alleys	32	41
Walking around	494	579
Other	279	643

Source: Seattle/King County Coalition on Homelessness, www.homelessinfo.org

Sheltered Homeless

At the time this Housing Appendix was being written, the portion of the 2016 One Night Count focusing on the sheltered population had yet to be released. A previous homeless needs assessment, including the sheltered population, was included in the 2014–2017 Consolidated Plan.

As described in that plan, King County Community Services Division tabulates information about the sheltered homeless population for the One Night Count. This information indicated that the two largest demographic segments of the sheltered homeless population in King County are 1) people in families with children and 2) single adult men age twenty-five years or older. While members of families with children comprise the majority (69 percent) of the transitional housing population, single adult men are the majority (57 percent) in emergency shelters. A substantial number of people identified as veterans. Reporting on issues such as disabilities and health conditions is voluntary. The most commonly reported disabilities and health conditions reported were mental illness, alcohol or substance abuse, and physical disability.

During the course of the 2012 Annual Homeless Assessment Report (AHAR) reporting year, Seattle shelters participating in the Safe Harbors system assisted more than 7,486 people in single-individual shelters (for households without children) as well as more than 1,072 people within families with one or more children.

The Consolidated Plan highlights a number of key findings regarding the characteristics of the sheltered homeless population, including:

- *Over half (58 percent) of the individuals in shelters for adults without children report having a disability.*
- *There were more than 643 children under the age of eighteen served in emergency shelters in Seattle, and over 43 percent of these were less than five years old.*
- *More than a third of the people in transitional housing programs for families with children were in a household with five or more people.*
- *People of color, particularly black/African Americans, are disproportionately represented among those who are homeless in the shelter/transitional housing system, representing 28 percent of people served in single-adult emergency shelters and 71 percent of people served in family shelters.*

Seattle Housing Market

Seattle grew by nearly 50,000 housing units between the beginning of 2005 and the end of 2015, the period since the last major update of the Comprehensive Plan in 2004.

Annual housing production in Seattle varied greatly over that period, influenced by broader economic trends including the eighteen-month Great Recession of December 2007 to June of 2009, and the more recent resurgence in the housing market. **(See Housing Appendix Figure A-17.)**

An initial peak in Seattle’s annual housing growth was reached in 2009 with production that year totaling nearly 7,000 net new units. This was followed by a precipitous drop in housing production due to the Great Recession. With recovery of the housing market, annual production accelerated rapidly between 2012 and 2014. In 2014, over 7,500 net new housing units were built, the highest peak recorded in the past twenty years.

Housing Appendix Figure A-17

Housing Units Built, Demolished, and Net New Units by Year (2005–2014)

Year	Units Built	Units Demolished	Net New Units
2005	3,669	(551)	3,118
2006	3,456	(575)	2,881
2007	4,531	(882)	3,649
2008	4,937	(985)	3,952
2009	7,334	(341)	6,993
2010	3,943	(309)	3,634
2011	2,305	(169)	2,136
2012	3,252	(577)	2,675
2013	6,621	(337)	6,284
2014	8,308	(760)	7,548
2015	7,587	(590)	6,997

Source: Citywide Residential Permit Report, OPCD, January 5, 2016

Consistent with Seattle’s Urban Village Strategy, the majority of housing units added in the city from 2005 to 2015 were built in urban centers and urban villages. Specifically, an estimated 39,587 units (79 percent of the 49,867 housing units added in the city during that

period) were built in urban centers and urban villages. This includes the addition of 23,186 units (46 percent of the city's total growth) in urban centers and the 16,429 units (33 percent of the city's total growth) in urban villages outside of centers.¹³

Owner Housing Market

Housing Appendix Figure A-18 provides a key to the eight NWMLS market areas in Seattle referred to in Housing Appendix Figures A-19, A-20, and A-21.

Housing Appendix Figures A-19 to A-21 provide data on median sales prices for closed sales from 2005 through 2014 for these areas. The home sales reflected in these Housing Appendix Figures include condominiums as well as other homes. Note that in the Downtown submarket area (#701), condominiums comprise 100 percent of home sales. Prices in all Housing Appendix Figures are inflation-adjusted to 2014 dollars.

Housing Appendix Figure A-18

Key to NWMLS Market Areas in Seattle

#	Area
140	West Seattle
380	Central Seattle SE, Leschi, Mt Baker, Seward Park
385	Central Seattle SW, Beacon Hill
390	Central Seattle, Madison Park, Capitol Hill
700	Queen Anne, Magnolia
701	Downtown Seattle
705	Ballard, Greenlake, Greenwood
710	North Seattle

Source: NWMLS King County statistical report for December 2014

As reflected in Housing Appendix Figure A-19, median sale prices in years following the Great Recession increased more slowly in South Seattle compared to the rest of the city. Median sale prices for 2014 were lower in the NWMLS market areas of West Seattle (area #140), Southeast Seattle (area #380), and Beacon Hill (area #385) compared to their previous peak highs in 2006 or 2007.

13. Source: Urban Center/Village Residential Growth Report, OPCD, January 5, 2016.

Housing Appendix Figure A-19

Median Sales Price for Residential Sales, Including Condos (NWMLS Area)

NWMLS area	2014	2013	2012	2011	2010	2009	2008	2007	2006	2005
140	\$400K	\$382K	\$339K	\$315K	\$374K	\$376K	\$427K	\$459K	\$462K	\$431K
380	\$391K	\$361K	\$309K	\$312K	\$354K	\$370K	\$410K	\$456K	\$450K	\$406K
385	\$340K	\$326K	\$266K	\$269K	\$322K	\$343K	\$385K	\$434K	\$415K	\$380K
390	\$660K	\$630K	\$618K	\$538K	\$562K	\$544K	\$608K	\$673K	\$687K	\$657K
700	\$710K	\$663K	\$582K	\$558K	\$636K	\$615K	\$701K	\$770K	\$767K	\$710K
701*	\$-	\$728K	\$340K	\$-	\$-	\$1.3M	\$-	\$793K	\$1M	\$653K
705	\$512K	\$475K	\$438K	\$422K	\$450K	\$435K	\$493K	\$548K	\$533K	\$492K
710	\$510K	\$479K	\$456K	\$433K	\$475K	\$465K	\$520K	\$570K	\$549K	\$516K

Source: NWMLS King County statistical report for December 2005 through 2014 (December 2014)

*Some data not shown in NWMLS report.

Housing Appendix Figure A-20 shows how median sale prices for new construction homes compare to the median sale prices for all residential sales in Seattle's submarkets. Based on NWMLS data for total residential sales closing in 2014, most market areas are showing substantially higher median sales prices for new construction homes.

Housing Appendix Figure A-20

New Construction Residential Sales (Compared to All Residential Sales)

NWMLS Submarket Area	New Construction: Median Sale Price Compared to All Residential Sales	New Construction: Share of Total Residential Sales
140	11% higher	11%
380	27% higher	9%
385	42% higher	9%
390	2% lower	11%
700	1% lower	6%
705	19% higher	4%
710	27% higher	11%

Source: NWMLS King County statistical report (December 2014)

Housing Appendix Figure A-21 displays median sales prices for new construction homes (again, including condominiums). Median sales prices for new-construction homes dipped after the Great Recession in all submarkets, but increased substantially in 2013 and 2014 in five of the seven neighborhood market areas outside of Downtown Seattle (area #701). Median sales prices in 2014 were still lower in the Southwest Seattle/Beacon Hill (area #385) and Queen Anne/Magnolia (area #700) market areas compared to 2006 peaks.

Housing Appendix Figure A-21

Median Sales Price by Seattle NWMLS Market Area for New-Construction Residential Sales, Including New-Construction Condominiums

NWMLS Market Area	2014	2013	2012	2011	2010	2009	2008	2007	2006	2005
140	\$444K	\$448K	\$309K	\$316K	\$358K	\$354K	\$411K	\$433K	\$444K	\$429K
380	\$497K	\$474K	\$350K	\$317K	\$402K	\$401K	\$395K	\$445K	\$468K	\$465K
385	\$482K	\$407K	\$313K	\$328K	\$422K	\$387K	\$471K	\$491K	\$498K	\$463K
390	\$650K	\$662K	\$586K	\$370K	\$495K	\$522K	\$493K	\$541K	\$551K	\$466K
700	\$700K	\$562K	\$590K	\$421K	\$488K	\$596K	\$625K	\$684K	\$782K	\$564K
701*	\$-	\$-	\$-	\$-	\$-	\$2.2M	\$-	\$-	\$-	\$-
705	\$607K	\$564K	\$531K	\$364K	\$391K	\$381K	\$449K	\$467K	\$514K	\$429K
710	\$650K	\$685K	\$457K	\$372K	\$396K	\$416K	\$437K	\$427K	\$580K	\$481K

Source: NWMLS King County statistical report for December 2005 through 2014 (December 2014)

*Some data not shown in NWMLS report.

Rental Housing Market

Average rents for market-rate apartments in Seattle have increased and are substantially higher in fall 2014 compared to 2005. Although they dipped slightly following the Great Recession, average rents resumed rising in 2011. Average rents then rose at an accelerated pace from 2011 to 2014.

One-bedroom apartments are the most common size of apartment unit in Seattle. Between 2005 and 2014, the average rent for one-bedroom apartments increased an estimated 35 percent. In these units, the average rent as measured per net rentable square foot (NRSF) increased an estimated 27 percent (*see Housing Appendix Figure A-22*).

Housing Appendix Figure A-22

Seattle Average Rent per Unit and per Net Rentable Square Foot
(1-Bedroom Apartment Units)

Year	Average Rent per 1-BR Unit	Average Rent per NRSF
2005	\$1,045	\$1.55
2006	\$1,047	\$1.54
2007	\$1,147	\$1.65
2008	\$1,148	\$1.66
2009	\$1,130	\$1.65
2010	\$1,135	\$1.62
2011	\$1,160	\$1.64
2012	\$1,206	\$1.70
2013	\$1,302	\$1.83
2014	\$1,412	\$1.97

Source: D+S Apartment Vacancy Report Fall 2014, City of Seattle

Housing Appendix Figure A-23 shows estimated average market rents for apartment units in the fourteen D+S-defined neighborhood market areas that are wholly within Seattle. For each market area, Housing Appendix Figure A-23 shows overall average rents as well as average rents by number of bedrooms. At approximately \$1,070 per unit, average rents are most affordable in the D+S Beacon Hill market area, followed by the Rainier Valley and North Seattle (generally north of 85th Street) market areas at approximately \$1,130 per unit. Average market rents in the Downtown and South Lake Union market areas are approximately 28 percent higher than the estimated average market rent of \$1,488 for Seattle as a whole.

Housing Appendix Figure A-23

Average Market Rents by Unit Type and Market Area

D+S Market Area	All Units	Studio	1-BR	2-BR/1-B	2-BR/2-B	3-BR/3-B
SEATTLE (city as a whole)	\$1,488	\$1,169	\$1,412	\$1,605	\$2,156	\$2,411
NORTH SEATTLE						
Ballard	\$1,563	\$1,244	\$1,489	\$1,696	\$2,345	\$1,850

D+S Market Area	All Units	Studio	1-BR	2-BR/1-B	2-BR/2-B	3-BR/3-B
Greenlake, Wallingford	\$1,557	\$1,347	\$1,444	\$1,599	\$2,170	\$2,115
North Seattle	\$1,130	\$988	\$1,020	\$1,252	\$1,407	\$1,749
University	\$1,361	\$1,094	\$1,240	\$1,441	\$1,968	\$1,963
CENTRAL SEATTLE						
Belltown, Downtown, South Lake Union	\$1,906	\$1,301	\$1,841	\$2,265	\$2,918	\$4,116
Capitol Hill, Eastlake	\$1,462	\$1,149	\$1,430	\$1,836	\$2,285	\$2,835
Central	\$1,446	\$1,131	\$1,380	\$1,534	\$1,934	\$2,191
First Hill	\$1,395	\$1,088	\$1,409	\$1,764	\$2,339	\$2,728
Madison, Leschi	\$1,370	\$930	\$1,284	\$1,577	\$1,694	
Magnolia	\$1,396	\$1,216	\$1,248	\$1,541	\$1,681	\$2,144
Queen Anne	\$1,525	\$1,117	\$1,469	\$1,767	\$2,309	\$2,579
SOUTH SEATTLE						
Rainier Valley	\$1,128	\$1,202	\$1,042	\$1,174	\$1,727	
Beacon Hill	\$1,071	\$890	\$1,055	\$1,318	\$1,226	
West Seattle	\$1,283	\$1,188	\$1,211	\$1,283	\$1,843	\$2,079

Source: D+S, *Apartment Vacancy Report, Fall 2014*

In the 14 D+S neighborhood market areas wholly within Seattle, the five-year average vacancy rate has been less than 5 percent. (A vacancy rate of 5 percent is commonly recognized as the equilibrium point signaling relative balance between supply and demand.) As of fall 2014, market vacancy rates were averaging between 0.4 percent and 3.8 percent of units in complexes with twenty or more units. In Seattle's three most affordable rental market areas—Beacon Hill, Rainier Valley, and North Seattle—vacancy rates were averaging an estimated 2.2 percent.

Housing Appendix Figure A-24 shows average rents per unit for apartment units in D+S's Seattle market areas by age of the apartment complex. Average rents are markedly higher for the newest cohorts of units. Seattle's most affordable rents are in complexes built over a century ago and in the 1970s.

Housing Appendix Figure A-24

Average Rent per Unit by Age of Housing

Age of Housing (Decade in Which Built)	Average Rent
2010 and later	\$1,822
2000–2009	\$1,731
1990–1999	\$1,550
1980–1989	\$1,230
1970–1979	\$1,083
1960–1969	\$1,117
1940–1959	\$1,174
1920–1939	\$1,137
1900–1919	\$1,060

Source: D+S, *Apartment Vacancy Report, Fall 2014*

Affordability of Seattle's Overall Housing Supply

In an earlier section, this appendix examined CHAS (2006–2010) data on housing cost burdens to provide insights into the challenges that specific types of Seattle households experience in affording the housing in which they live. CHAS data can also be used to describe the affordability of a community's housing supply independently of the households who currently live in the housing units.

This section uses the CHAS (2006–2010) data in this manner in order to describe the affordability of Seattle's housing supply. The CHAS data summarized here categorize the affordability of each housing unit based on the income level that any household would need in order to afford the monthly housing costs associated with the unit. The analysis to produce these tables takes into account the fact that housing needs vary by household size.¹⁴

As noted in Data Sources above, the CHAS data do not distinguish between housing units that are rent/income-restricted and housing units that are market-rate (i.e., those without regulatory agreements or covenants). The estimates from the ACS CHAS data on the

14. This analysis for Seattle is based on the affordability and availability methodology described in "Measuring Housing Affordability," by Paul Joice, US Department of Housing and Urban Development, *Cityscape: A Journal of Policy Development and Research*, Volume 16, Number 1, 2014. A variety of other entities, including the Philadelphia Federal Reserve bank and the Washington State Affordable Housing Advisory Board, have used similar analyses to assess housing needs at local and state levels.

affordability of Seattle's housing supply refer to affordability in a broad sense; units tabulated as affordable to households at specified income levels may include market-rate as well as rent/income-restricted housing.

Affordability of Owner Units

In order to represent the monthly costs associated with an owner-housing unit in a way that is independent of any household currently in the unit, the CHAS tabulations simulate a situation in which a household has recently purchased the unit and is making payments on an FHA-insured, thirty-year mortgage under prevailing interest rates.¹⁵ In the CHAS tabulations, HUD considers monthly mortgage payments to be affordable at a given income level when these payments consume no more than 31 percent of monthly income. The analytical approach reflected in these tabulations provides a useful, but limited picture of ownership housing affordability in Seattle.¹⁶

For owner units, the CHAS data estimates the number of owner units affordable with household incomes of 0–50 percent of AMI, 50–80 percent of AMI, 80–100 percent of AMI, and above 100 percent of AMI. Housing Appendix Figure A-25 shows the estimated number of owner units in Seattle that are affordable within each of these affordability categories. Cumulative estimates are also shown for units affordable with household incomes at or below 80 percent AMI, and units affordable at or below 100 percent of AMI. Occupied owner units and vacant for-sale units are shown in separate columns and summed in the third column.

The analysis shows that very small numbers of owner units are affordable within the income categories of 0–50 percent of AMI and 50–80 percent of AMI. On a cumulative basis, only about 4,500 owner units, or 3 percent of the total owner units, are estimated to be affordable at or below 80 percent of AMI. Another 5 percent are estimated to be affordable at 80–100 percent of AMI.

-
15. CHAS tabulations on affordability of owner units use the home value that respondents provided on the ACS questionnaire. To categorize owner units by affordability, the CHAS tabulations assume that the hypothetical owner has purchased the home at a sales price equal to the home value provided in the ACS, and—as noted—is currently making mortgage payments.
 16. CHAS tabulations on affordability of owner housing supply do not capture the ways that accumulation of equity in a home after purchase can affect a home's affordability over time. These tabulations also ignore the question of whether the down payments involved would be affordable to households.

Housing Appendix Figure A-25

Affordability of Owner Units

	Occupied owner units	Vacant for-sale units	Total owner units
Owner units:	136,304	2,955	139,259
By affordability category:			
Affordable with income of 0–50% of AMI	2,410	0	2,410
Affordable with income of 50–80% of AMI	1,939	15	1,954
Affordable with income of 80–100% of AMI	6,920	205	7,125
Affordable with income above 100% of AMI	125,035	2,735	127,770
By affordability level (cumulative):			
Affordable with income at or below 80% of AMI	4,349	15	4,364
Affordable with income at or below 100% of AMI	11,269	220	11,489

Source: CHAS (2006–2010)

Notes: The CHAS tables summarized in Housing Appendix Figure A-25 exclude an estimated 750 owner-occupied and fifty vacant, for-sale housing units in Seattle that lack complete plumbing and kitchen facilities.

Affordability of Rental Units

Rental units are regarded as affordable at a given income level if monthly gross rent, defined as contract rent plus tenant-paid basic utilities, equals no more than 30 percent of monthly gross income.

Housing Appendix Figure A-26 shows the estimated numbers of rental units that are affordable by income category. (The housing affordability categories included in the CHAS data for rental housing differ somewhat from those for owner housing and include more detail in the lowest part of the income spectrum.)

Only 11 percent of the total Seattle rental units have gross rents that are affordable with an income at or below 30 percent of AMI. About 22 percent of rental units are affordable in the 30–50 percent of AMI category. Another 42 percent of rental units are affordable in the 50–80 percent of AMI category.

Housing Appendix Figure A-26

Affordability of Rental Units

	Occupied rental units	Vacant for-rent units	Total rental units
Rental units	139,625	5,305	144,930
By affordability category:			
Affordable at income of 0–30% AMI	16,325	340	16,665
Affordable at income of 30–50% AMI	31,060	1,495	32,555
Affordable at income of 50–80% AMI	59,355	1,790	61,145
Affordable at income above 80% AMI	32,885	1,680	34,565
By affordability level (cumulative):			
Affordable at income at or below 50% AMI	47,385	1,835	49,220
Affordable at income at or below 80% AMI	106,740	3,625	110,365

Source: CHAS (2006–2010)

Notes: A household unit is affordable if rent and basic utilities together cost no more than 30 percent of household income. The analysis in this table assumes the household size to unit size ratios that HUD uses to administer the Low-income Housing Tax Credit program. The CHAS tables summarized in Housing Appendix Figure A-26 exclude the estimated 3,760 occupied rental-housing units that lack complete plumbing and kitchen facilities.

Maps Showing Affordability Levels of Existing Housing

The following maps show census tracts in and around Seattle, with shading indicating the shares of housing units within each tract that are estimated to be affordable at or below a specified household income level. These maps were generated using HUD’s CPD maps tool and are based on CHAS (2007–2011) tabulations.

The census tracts in these maps are shaded based on “natural breaks” in the distribution of data in order to highlight variation in and around Seattle. As the map legends indicate, the data categories vary from one map to another; this is important to keep in mind when viewing these maps.

The maps in this series were generated separately for owner housing units and renter housing units. They include:

- Estimated shares of owner housing units within census tracts that are:

- *affordable at or below 80 percent of AMI (Housing Appendix Figure A-27)*
 - *affordable at or below 100 percent of AMI (Housing Appendix Figure A-28)*
- *Estimated shares of rental housing units within census tracts that are*
 - *affordable at or below 30 percent of AMI (Housing Appendix Figure A-29)*
 - *affordable at or below 50 percent of AMI (Housing Appendix Figure A-30)*
 - *affordable at or below 80 percent of AMI (Housing Appendix Figure A-31)*

As reflected in these maps, the affordability of housing varies a great deal between areas within Seattle and surrounding cities.

Shares of Owner Housing Units by Affordability Level

Owner units affordable at or below 80 percent of AMI are very scarce within Seattle and in neighboring cities east of Lake Washington. The vast majority of census tracts in Seattle and these Eastside cities are tracts where only 6 percent or fewer of the owner units are affordable at or below 80 percent of AMI.

Owner units affordable at or below 100 percent of AMI are also scarce in most census tracts within Seattle and Eastside cities. Census tracts to the south of Seattle and to the northeast of Seattle have larger proportions of owner units affordable at or below these income thresholds.

Shares of Rental Housing Units by Affordability Level

The large majority of census tracts in and around Seattle have very low shares of rental units affordable at or below 30 percent of AMI. Rental units affordable at or below 50 percent of AMI make up 21 percent or less of the residential rental units in most Seattle census tracts. Within the mapped area, the largest shares of rental units affordable at or below 50 percent of AMI are primarily found in Southeast Seattle and south of Seattle.

Rental units affordable at or below 80 percent of AMI are notably more common in and around Seattle than are rental units affordable at or below the lower income thresholds. Still, rental units affordable at or below 80 percent of AMI make up well below half of the rental units in portions of Seattle and in large areas of neighboring cities to the east. Furthermore, units affordable at or below 80 percent of AMI make up large majorities of rental units in only a small number of census tracts, most of which are south of Seattle's city limits.

Housing Appendix Figure A-27

Share of Owner Units Affordable at or Below 80 Percent of AMI

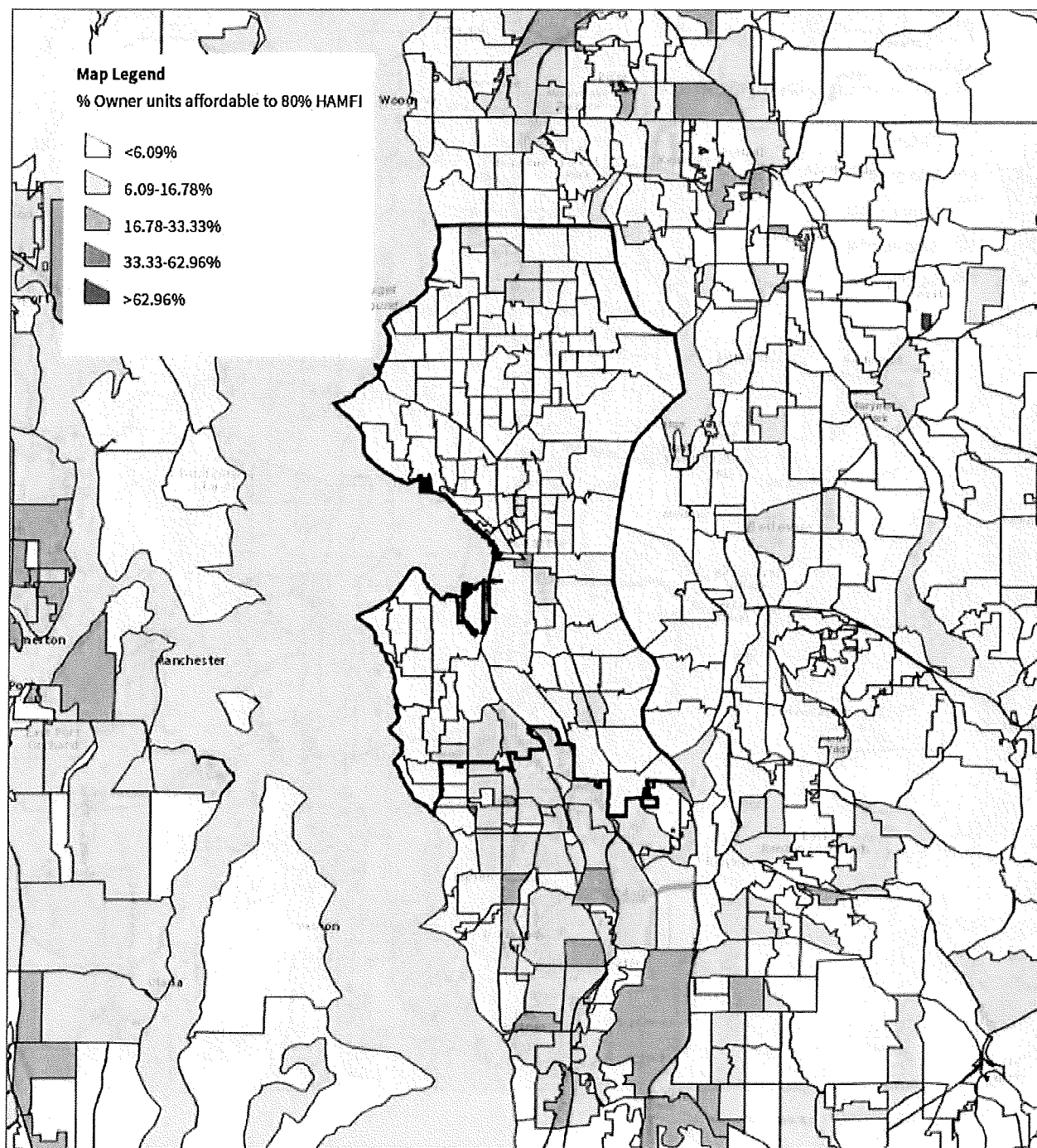

Source: CHAS (2007-2011)

Housing Appendix Figure A-28

Share of Owner Units Affordable at or Below 100 Percent of AMI

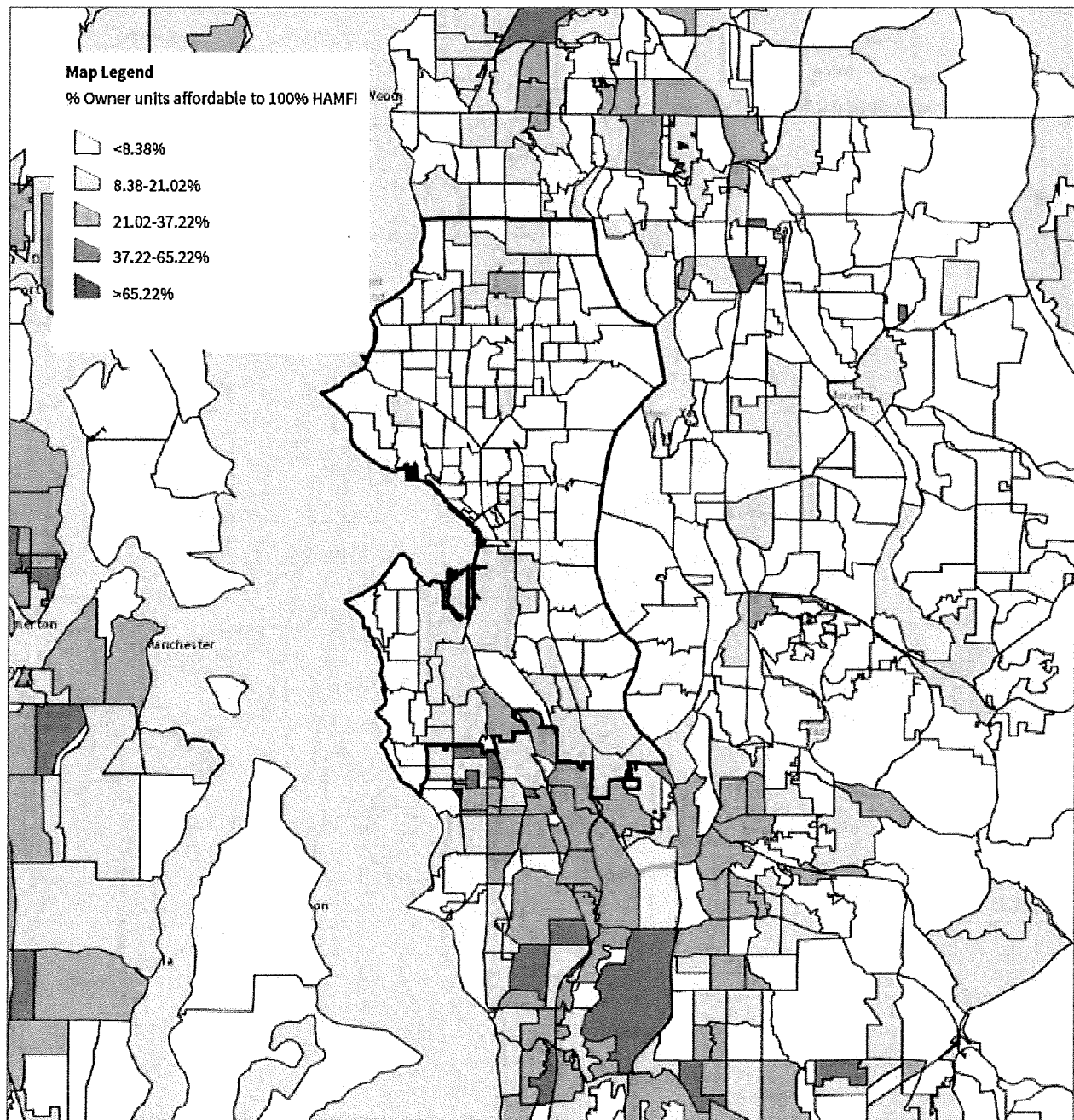

Source: CHAS (2007-2011)

Housing Appendix Figure A-29

Share of Rental Units Affordable at or Below 30 Percent of AMI

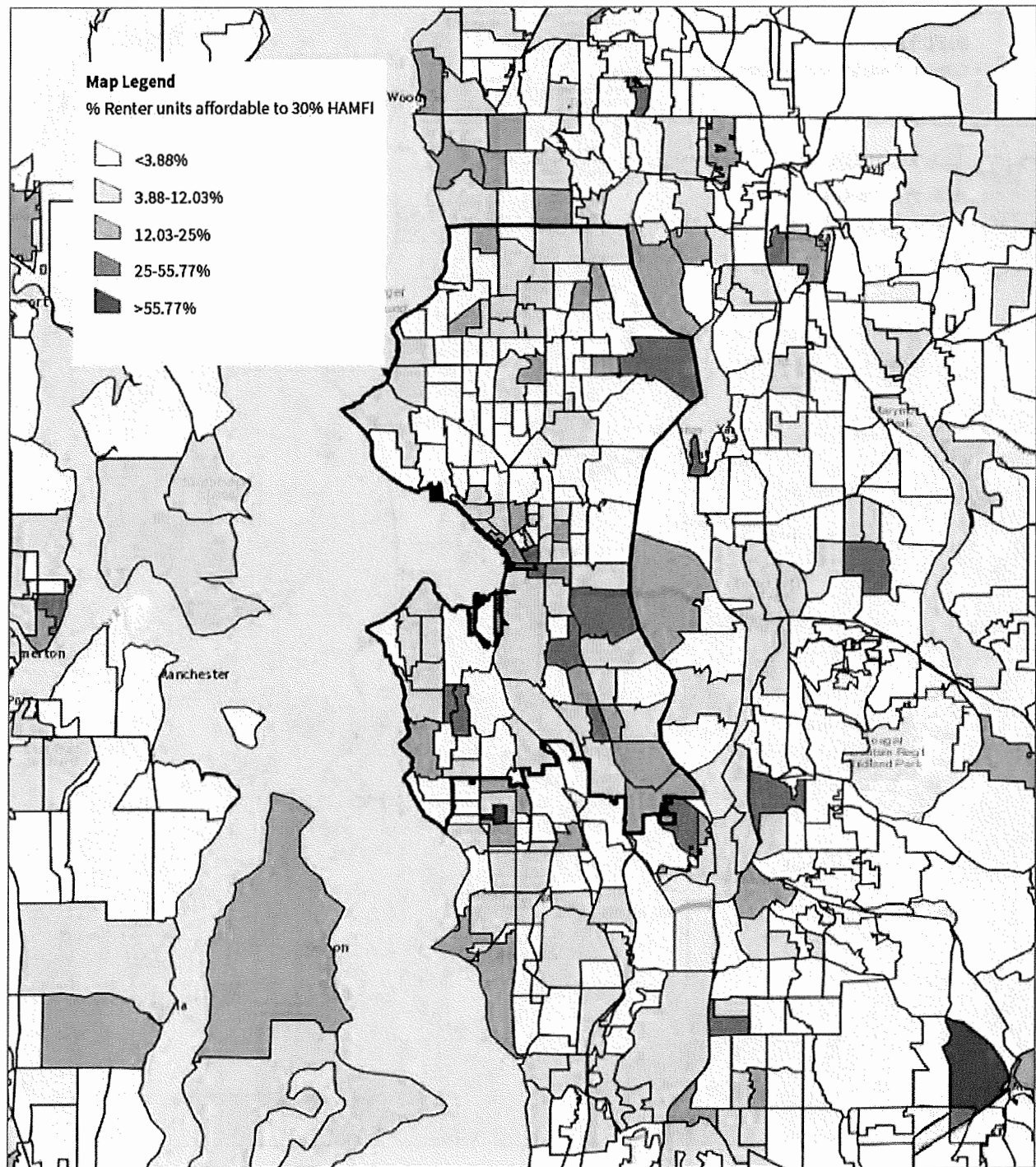

Source: CHAS (2007-2011)

Housing Appendix Figure A-30

Share of Rental Units Affordable at or Below 50 Percent of AMI

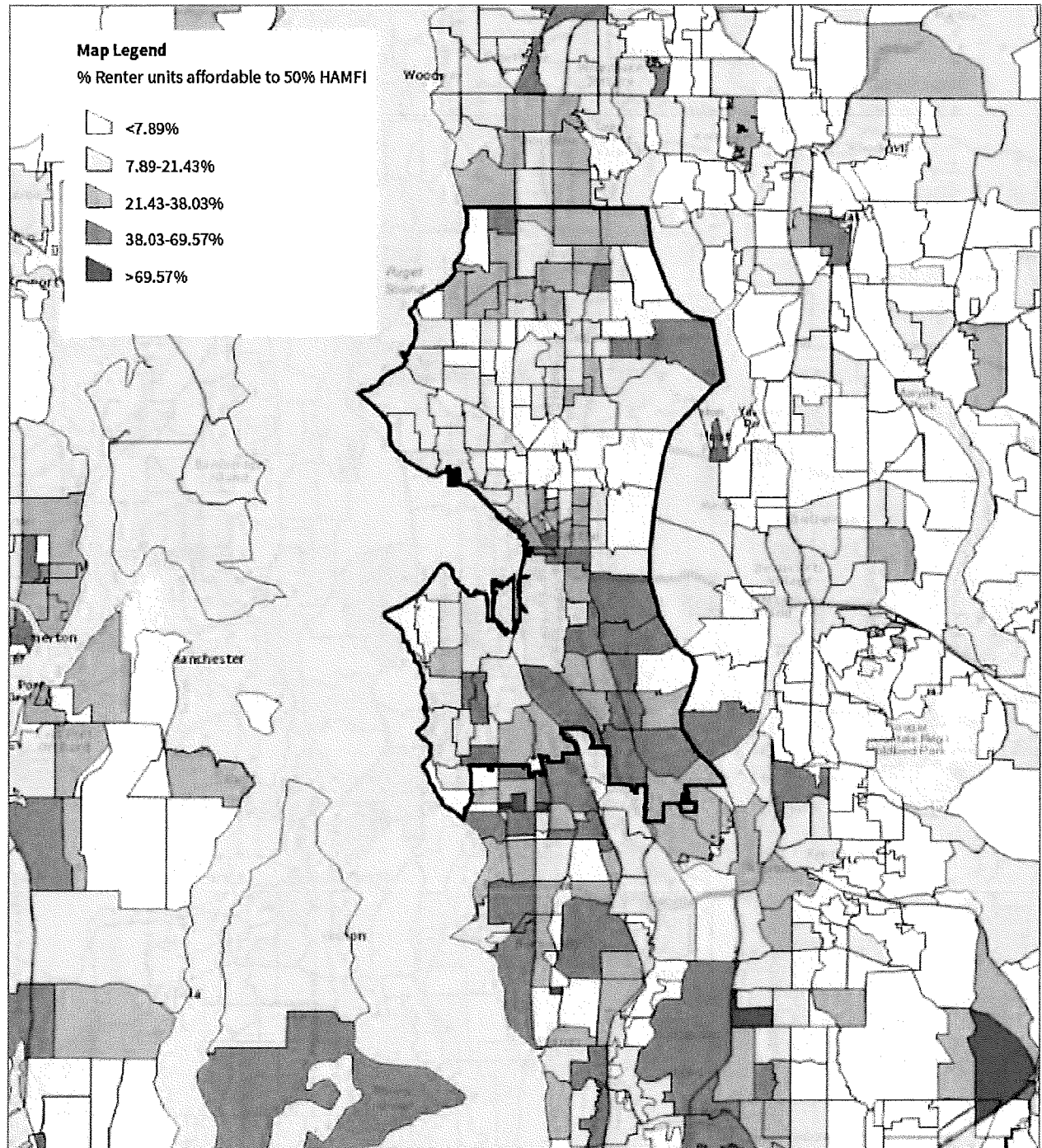

Source: CHAS (2007-2011)

Housing Appendix Figure A-31

Share of Rental Units Affordable at or Below 80 Percent of AMI



Source: CHAS (2007-2011)

Affordability and Availability of Rental Units in Seattle

The city-level analysis of affordability presented earlier in this appendix used the CHAS (2006–2010) tabulations to estimate how much of Seattle’s overall rental housing supply is affordable within lower income categories. Those findings provide useful but incomplete information about the degree to which the current affordability profile of rental housing in Seattle meets existing needs.

As previously described, both market-rate and rent/income-restricted housing units are included in the CHAS data used to analyze affordability. This helps provide a broad picture of the affordability of rental housing in the city. At the same time, it is important to consider that market-rate rental units affordable at or below a given income threshold can be occupied by households with incomes higher than that threshold.

Understanding whether rental housing is affordable to renters requires finding out if housing units affordable to households with incomes at or below the 30 percent, 50 percent, and 80 percent of AMI thresholds are actually *available* to households with incomes at or below these thresholds.

Therefore, this section dives deeper into the CHAS data to analyze the number of rental units both affordable *and available* to households at these income levels. In this analysis, units that are affordable are also considered available if they are either vacant or occupied by a household whose income is at or below the specified threshold.

Housing Appendix Figure A-32 shows the total number of renter households in each income category, the number of rental units with rents that are affordable in that category, and the number of those units that are occupied by households in that category. These numbers are used to estimate the effective shortage or surplus of affordable and *available* rental units that exists at or below each of the specified income levels.

For example, 5,300 of the roughly 16,665 (occupied or vacant) units “affordable” at or below 30 percent of AMI are *occupied* by a household with an income that is higher than 30 percent of AMI. Thus, although those 5,300 units are nominally affordable, they are not actually *available* to households with incomes at or below 30 percent of AMI.

That leaves roughly 11,365 affordable *and available* rental units (Housing Appendix Figure A-32, Row G) to serve approximately 34,820 renter households (Row A) and thus an effective shortage of approximately 23,455 units (Row I). This effective shortage is substantially worse than the nominal shortage of approximately 18,155 units (Row H) because the nominal shortage does not account for availability.

These findings can also be expressed in ratios. For example, for every 100 Seattle renter households who have incomes at or below 30 percent of AMI, there are forty-eight affordable units. However, fifteen of these affordable units are occupied by households with incomes above 30 percent of AMI. Thus, for every 100 renter households with incomes at or below 30 percent of AMI, there are estimated to be only thirty-three rental units that are affordable and available.

Housing Appendix Figure A-32

Affordability and Availability of Rental Units at Specified Income Levels

		0-30% of AMI	0-50% of AMI (cumulative)	0-80% of AMI (cumulative)
A	Total renter households with household incomes at or below-income level	34,820	56,835	82,650
B	Occupied rental units that are affordable <i>and available</i> (i.e., units with rent affordable to households at the specified income level and occupied by renters at or below that income level)	11,025	30,050	69,685
C	Occupied rental units that are affordable, but <i>not available</i> (i.e., rental units with rents are affordable at or below the specified income level but occupied by households above that income level)	5,300	17,335	37,055
D	All occupied rental units that are affordable (i.e., occupied rental units that have rents affordable at the specified income level, ignoring income of current occupant household) (B+C)	16,325	47,385	106,740
E	Vacant for-rent units that are affordable <i>and available</i> at or below-income level	340	1,835	3,625
F	Total rental units that are affordable (i.e., total units—occupied or vacant—with rents affordable to households at specified income level) (D+E)	16,665	49,220	110,365
G	Total rental units that are affordable <i>and available</i> at or below-income level (B+E)	11,365	31,885	73,310
H	Nominal shortage or surplus of affordable rental units at or below-income level (A-F) when only considering affordability and not availability	Shortage: 18,155	Shortage: 7,615	Surplus: 27,715
I	Effective shortage or surplus of affordable <i>and available</i> rental units at or below-income level (A-G) when availability is considered	Shortage: 23,455	Shortage: 24,950	Shortage: 9,340
J	Affordable rental units per 100 renter households at or below-income level (F/A * 100)	48	87	134

		0–30% of AMI	0–50% of AMI (cumulative)	0–80% of AMI (cumulative)
K	Affordable and available rental units per 100 renter households at or below-income level (G/A * 100)	33	56	89

Source: CHAS (2006–2010). Notes: Housing estimated 3,760 occupied rental housing units and 300 vacant for-rent units that lack complete plumbing and kitchen facilities. The household estimates, however, encompass all renter households, including those who live in rental units lacking complete plumbing.

Examining affordability *and* availability reveals substantially larger gaps between existing rental supply and the need for housing at these income levels than the gaps found when considering affordability alone.

However, even this affordability and availability analysis in some ways underestimates unmet needs in Seattle for affordable housing.

- *The estimated shortages of rental housing at each income threshold do not reveal the likely variation in the size of shortages within each of the constituent income ranges under the threshold. For example, the size of the shortage confronted by households at 60 percent of AMI is likely closer to the shortage found at 50 percent of AMI than it is to the shortage at 80 percent of AMI; and this is likely the case even though 60 percent of AMI is under the same income range as 80 percent of AMI.¹⁷*
- *Rents in Seattle have risen substantially since the 2006–2010 period captured in the analysis summarized by Housing Appendix Figure A-32.*
- *This affordability and availability analysis only addresses rental housing and renter households.¹⁸ The information presented in earlier sections on the affordability of owner housing and the high prevalence of housing cost burdens among lower-income households are indicators that, similarly, there is scant availability of owner housing affordable to lower-income households, including households specifically in the low-income category.*
- *The households in the analysis are limited to those living in housing units; as a result, the estimated shortages do not factor in the housing needs of homeless people in Seattle who are living on the streets or in temporary shelters.*

17. Tabulations needed to estimate shortages at finer income increments are not provided in the CHAS dataset. However, other tabulations in the CHAS show that the estimated prevalence of cost burdens and other housing problems tends to be higher for households closer to the bottom than the top of the 30 percent to 50 percent of AMI range as well as closer to the bottom than the top of the 50 percent to 80 percent of AMI income range.

18. Results from a similar analysis of owner housing affordability and availability would be difficult to interpret due to the way that households pay for and consume owner-occupied housing over time, which is very different than the way renters pay for housing.

- *Furthermore, the data used for this analysis—like much of the other data analyzed in this appendix—is only about Seattle households. This excludes households (such as those whose members work in Seattle) who may desire to live inside of Seattle but live in surrounding areas. Some households outside of Seattle likely do so to access housing they can afford.*

Estimated Household Growth and Projected Housing Needs by Income Level

As described earlier in this appendix, the City is planning for the net addition of 70,000 households in the next twenty years. In order to project the amount of housing that will be needed by income level within the planning period, this analysis makes some simplifying assumptions.

Housing Appendix Figure A-33 takes the income distribution of Seattle's existing households, which is based on the income distribution found in the CHAS (2006–2010) estimates, and overlays this income distribution on the planned net new 70,000 households.

Assuming that the income distribution for the net new households would be the same as for existing Seattle households, Housing Appendix Figure A-33 shows that:

- *approximately 15 percent (or about 10,500) of the 70,000 additional households would have incomes of 0–30 percent of AMI,*
- *an additional 11 percent of the 70,000 (about 7,500) would have incomes of 30–50 percent of AMI, and*
- *14 percent (about 9,500) would have incomes of 50–80 percent of AMI.*

On a cumulative basis, 26 percent (or 18,000) of the net new households would have incomes at or below 50 percent of AMI, and 40 percent (or 28,000) would have incomes at or below 80 percent of AMI.

Housing Appendix Figure A-33

Estimated Household Growth by Income Level

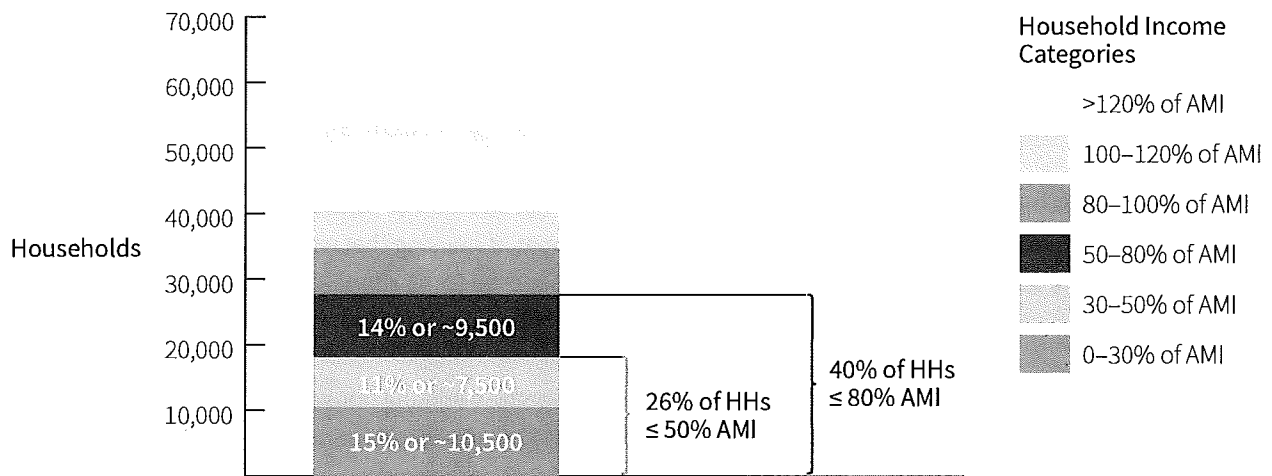

Projecting the amount of affordable housing needed to be affordable at each income level also requires analytical assumptions about how need could be met.

- *If affordability needs are met entirely with rent/income-restricted housing, the estimated amount of housing needed for households with incomes in the 0-30 percent of AMI, 30-50 percent of AMI, and 50-80 percent of AMI income categories will be the same as the number of households in each of these income categories.*
- *If affordability needs within these income categories are met with a combination of rent/income-restricted housing and nonrestricted (i.e., market-rate) units, the amount of affordable housing needed at or below-income thresholds will be higher than the corresponding number of households. This is to address the issue of availability—that is, some of the low cost market-rate units will be occupied by households above income thresholds. Findings from the affordability and availability analysis conducted for Seattle’s existing housing supply can provide insight for projecting future need. At each income level analyzed, that analysis found that there are about one and a half affordable units for every affordable and available unit.¹⁹*

Based on the assumptions and considerations above, the amount of affordable housing needed for the subset of the 70,000 net new households in lower income categories can be expected to be at least the same as the household numbers shown in Housing Appendix Figure A-33, and could potentially be up to one and a half times those numbers.

19. See Housing Appendix Figure A-32 Rows F and G. Figures in Housing Appendix Figure A-32 reflect the existing combination of rent/income-restricted units and market-provided units.

Following are the estimated numbers of units at each income level that would be needed in order to address affordability needs associated with the addition of 70,000 households.²⁰

- *For households with incomes of 0–30 percent of AMI: 10,500 rent/income-restricted housing units (assumes that all units affordable within this category would be rent/income-restricted housing, given that it would be extremely unlikely that the market would produce new units affordable at this income level without subsidy or regulatory intervention).*
- *For households with incomes of 30–50 percent of AMI: 7,500 rent/income-restricted housing units (with need met entirely by rent/income-restricted housing) or an additional 11,500 affordable units (if need could be met with a combination of rent/income-restricted housing and nonrestricted units²¹).*
- *For households with incomes of 50–80 percent of AMI: 9,500 rent/income-restricted housing units (if need met entirely with rent/income-restricted housing) or 14,500 affordable units (if need could be met with a combination of rent/income-restricted housing and nonrestricted units).*

Summing these figures together indicates that addressing the affordability needs of the 70,000 new households would require production of roughly 27,500 to 36,500 housing units affordable at or below 80 percent of AMI. This is in addition to affordable housing to address existing unmet need.

The foregoing discussion underscores the vital role that subsidized housing and other types of rent/income-restricted housing will continue to play in addressing the affordability needs of lower-income households. Over the next twenty years, the production of rent/income-restricted housing will continue to be essential, especially at the lowest income levels, which the housing market—particularly newly built market-rate housing—rarely addresses.

The following section describes the City’s strategies for addressing affordable housing needs. Through these strategies, Seattle responds to local needs within our city and helps address countywide need as required by the CPPs.

20. Figures given for the units needed in each income category assume needs in previous categories are met.

21. The 11,500 figure is provided as a reminder that availability as well as affordability must be factored in when a portion of affordable units are not rent/income-restricted. However, it is unlikely that any sizable number of market-rate units would be affordable in this range.

Strategies for Addressing Housing Needs

The City of Seattle's Office of Housing administers several affordable housing programs, which all help lower income families and individuals to thrive, and enable neighborhoods to provide a full range of housing choice and opportunity. The City's housing programs help build strong, healthy communities. The rent/income-restricted housing achieved through production and preservation of affordable housing, through both capital subsidies and developer incentives, help to stabilize lower-income residents in their neighborhoods and increase opportunities for people to live in our City. These strategies are informed by knowledge of local needs as well as an understanding of the needs in King County as a whole.

Office of Housing Programs: Rental Housing Program

OH's Rental Housing Program provides capital funding for the development of affordable rental housing in Seattle using funds from the Seattle Housing Levy, payments contributed by developers through the incentive zoning program, and federal grants. OH coordinates with other public and private funders to leverage these resources 3 to 1, with the largest sources of leverage coming from low-income housing tax credits and tax-exempt bond investment. Funding is generally provided in the form of low-interest, deferred-payment loans and is awarded on a competitive basis. It is available to parties from both the nonprofit and for-profit sectors, although the former have been the most active in the development and ownership of Seattle's rent/income-restricted housing to date.

- *2014 Funding: \$29.6 million, including \$17.5 million in Housing Levy, \$5.1 million in federal grants, \$4.9 million of incentive zoning funds, and \$2.1 million in other funding*
- *2014 Production: 445 rent/income-restricted housing units, including 315 new construction units and rehab of 130 units in the existing portfolio*
- *Total Portfolio: Cumulative production of nearly 12,000 rent/income-restricted housing units since 1981, largely funded by voter-approved housing levies*
- *Affordability Term: Minimum fifty years*
- *Income Limits: Generally at or below 60 percent of AMI, with over half of all rent/income-restricted housing units reserved for households with incomes less than 30 percent of AMI. Of actual households served, 76 percent have incomes 0 to 30 percent of AMI, 17 percent have incomes 30 to 50 percent of AMI, and 6 percent have incomes 50 to 80 percent of AMI.*
- *Populations Served: General priorities include formerly homeless individuals and families, seniors and people with disabilities, and low-wage working households.*

- *Web Link:* <http://www.seattle.gov/housing/housing-developers/rental-housing-program>

Incentive Zoning for Affordable Housing

In certain zones, Seattle's incentive zoning program enables development to achieve extra floor area beyond a base limit when affordable units are provided ("performance option") or when a fee is paid to support the development of affordable housing ("payment option"). With the latter option, the affordable units can be built either in that same neighborhood or in other neighborhoods with light rail or other direct frequent transit connections to areas experiencing employment and residential growth.

- *2014 Production: Fifty-one units produced on-site in six projects, and \$21.5 million of in-lieu payments*
- *Total Portfolio: 115 rent/income-restricted housing units in twenty-one projects since 2010, and \$52.9 million of in-lieu payments since 2001*
- *Affordability Term: Minimum fifty years*
- *Income Limits: Up to 80 percent of AMI for rental and 100 percent of AMI for owner-occupied housing; in-lieu payments support the Rental Housing and Homeownership Programs*
- *Web Link:* <http://www.seattle.gov/housing/housing-developers/incentive-zoning>

Multifamily Tax Exemption

Multifamily tax exemption is a voluntary program providing a property tax exemption to property owners on residential improvements for up to twelve years. Until recently, 20 percent of the housing units in participating buildings were required as rent/income-restricted housing. Beginning in November 2015, eligible buildings must set aside 25 percent of all units as rent/income-restricted housing, unless the buildings provide a minimum number of two-bedroom or larger apartments, in which case a 20 percent set-aside is required. The tax exemption is currently available in all multifamily zoned parcels in Seattle. Approximately 40 percent of all eligible projects currently in development are opting to participate in the multifamily tax exemption program. The program complements a separate State property tax exemption for residential development with 75 percent of units serving households at or below 50 percent of AMI.

- *2014 Production: 485 rent/income-restricted housing units in twenty-nine projects approved*

- *Total Portfolio: 3,841 rent/income-restricted housing units in 123 projects since 1998, with another 2,346 units in 106 projects expected to be complete by 2018*
- *Affordability Term: Up to twelve years*
- *Income Limits: Up to 40–90 percent of AMI, depending on the housing type*
- *Web Link: <http://www.seattle.gov/housing/housing-developers/multifamily-tax-exemption>*

Homeownership Program

OH provides up to \$45,000 per household in down payment assistance to low-income first-time homebuyers, typically in the form of low-interest, deferred-payment second mortgages. For resale-restricted homes, OH will provide up to \$55,000. The program is marketed through partner nonprofits and lending institutions, who often supplement City funds with subsidies from additional federal and local sources. OH also funds homebuyer counseling and recently launched a foreclosure prevention outreach campaign to connect homeowners with needed resources.

- *2014 Funding: \$1.5 million awarded, including \$1.3 million in Housing Levy and \$124,000 in other funding*
- *2014 Production: Forty homebuyers assisted*
- *Total Portfolio: 982 homebuyers assisted since 2004, largely funded through voter-approved Housing Levies*
- *Income Limits: Up to 80 percent of AMI*
- *Web Link: <http://www.seattle.gov/housing/renters/buy-a-home>*

HomeWise Weatherization

The HomeWise program provides energy efficiency, and health and safety improvements to houses and apartment buildings with lower-income households. Typical investment ranges from \$6,000 to \$12,000 per unit.

- *2014 Funding: \$3.2 million total, including \$112,000 from the State, \$1.2 million from utilities, and \$1.9 million in federal funds*
- *2014 Production: 499 units, including 191 single-family and 308 multifamily units*

- *Total Portfolio: 16,345 units since 2000*
- *Affordability Term: Three years for rental housing weatherization; no ongoing affordability requirement for homeowners*
- *Income Limits: Eligibility varies depending on source of funding.*
- *Web Link: <http://www.seattle.gov/housing/homeowners/weatherization>*

Home Repair Loan Program

The Home Repair Loan Program helps low-income homeowners finance critical home repairs. Eligible homeowners apply for a zero percent or 3 percent loan of up to \$24,000 (with a maximum lifetime benefit of \$45,000) for a term of up to twenty years. The program's goals are to identify and make health, safety, and code-related repairs, increase home energy-efficiency, and help revitalize neighborhoods.

- *2014 Funding: \$225,000 total from CDBG*
- *2014 Production: Thirteen loans*
- *Total Portfolio: ~2,900 loans to date*
- *Affordability Term: No ongoing affordability requirement*
- *Income Limits: Up to 80 percent of AMI*
- *Web Link: <http://www.seattle.gov/housing/homeowners/home-repair>*

Seattle's Rent/Income-Restricted Housing Inventory

OH estimates that Seattle has over 27,000 rent/income-restricted housing units for lower-income households. The middle columns in Housing Appendix Figure A-34 provide a summary of Seattle's approximate rental housing inventory with housing covenants, agreements, or other restrictions by rent/income limit and location of the housing by type of urban center/urban village. This 27,000-unit estimate does not include portable tenant-based Section 8 vouchers.

Housing Appendix Figure A-34

Estimated Rent/Income-Restricted Housing by Income Category and Location

Urban Centers/Villages	Rent/Income-Restricted Housing Units by Income Category			Total units AMI	Estimated Total Housing Units
	≤ 30% AMI	>30 to 60% AMI	>60 to 80% AMI		
Outside of Urban Center/Village	2,642	1,357	712	4,711	183,037
Urban Centers	6,403	4,101	1,087	11,591	65,412
Hub Urban Villages	976	2,677	364	4,017	20,886
Residential Urban Villages	2,507	3,318	1,031	6,856	38,377
Manufacturing Industrial Centers	41	1	0	42	345
Grand Total	12,569	11,454	3,194	27,217	308,057

Sources: Office of Housing; Survey of Rent/Income-restricted Housing 2008 and Multifamily Database 2014; Development Capacity Report, DPD, September 2014, p. 5.

Based on OH rent/income-restricted housing and DPD total housing unit estimates, slightly less than 9 percent of Seattle's total housing units are rent/income-restricted housing. Specifically, 4.1 percent are rent restricted for households with incomes ≤ 30 percent of AMI, 3.7 percent are rent restricted for households with incomes ≤ 60 percent of AMI, and 1.0 percent are rent restricted for households with incomes ≤ 80 percent of AMI. Over 80 percent of Seattle's 27,000-plus rent/income-restricted housing units are located in urban centers and villages helping lower income households with better access to retail, transit, and other services and amenities.

Seattle's estimated rent/income-restricted housing inventory of over 27,000 units includes approximately 15,000 rental units in the City of Seattle's portfolio of housing. Funding for these units comes from OH's Rental Housing Program or Multifamily Tax Exemption Program, incentive zoning programs in which residential building owners have participated, or through other agreements.

A HUD inventory identifies roughly seventy-five buildings totaling 3,500 rent/income-restricted housing units with regulatory agreements that could expire between now and 2035. However, it is important to note that the actual universe of units in Seattle that may be at risk of loss of affordability is smaller for a number of reasons. The actual universe is smaller because the HUD list includes buildings that (a) are located outside of the city of Seattle; (b) have been funded by the Seattle Office of Housing (OH), which routinely monitors the long-term affordability restrictions for OH-funded housing; (c) have mortgage loans insured under Section 221(d)(4), for which affordable housing set asides are not required; and (d) are owned by entities with a mission of providing long-term affordable housing for lower-income households.



Capital Facilities Appendix

The following sections contain the inventory and anticipated needs for various capital facilities. Information for utilities, such as drinking water, drainage and sewer, solid waste, and electricity, is included in the Utilities Appendix. Information for transportation facilities is included in the Transportation Appendix.

Fire Department

Inventory

The Seattle Fire Department (SFD) provides fire protection and emergency medical services throughout the City from thirty-three fire stations, marine facilities, and Harborview Medical Center. SFD headquarters is in an historic building in Pioneer Square. SFD shares the Joint Training Facility with Seattle Public Utilities. Each station provides a full range of fire protective services including fire suppression, emergency medical, and rescue. Each station is equipped with at least one fire engine. Many stations include other equipment and special units. SFD has thirty-three engine companies, twelve ladder truck companies, four fire boats, five aid units, eight paramedic units, and other specialized units including heavy rescue, hazardous materials, and tunnel rescue that provide a broad range of emergency services. Existing fire facilities are shown in Capital Facilities Appendix Figures A-1 and A-2.

Planning Goals

SFD evaluates emergency medical capabilities and staffing or equipment additions and institutes operation changes each year as a part of the budget process. State law requires that fire departments report yearly on established emergency response standards. SFD reports response time for fire response and emergency medical services (EMS), which includes basic life support (BLS) and advanced life support (ALS). Response standards are:

- *Call Processing Time: Sixty seconds for phone answered to first unit assigned, for 90 percent of calls.*
- *Fire Response Time: Arrival within four minutes for first-arriving engine at a fire for 90 percent of calls, and arrival within eight minutes of the full first alarm assignment of fifteen firefighters, for 90 percent of calls.*
- *Basic Life Support: Arrival within four minutes of the first medical unit with two EMTs, for 90 percent of calls.*
- *Advanced Life Support: Arrival within eight minutes for 90 percent of calls.*

Response time is influenced directly by the availability of fire personnel, equipment, traffic conditions, and the number and location of fire stations. Firefighter and equipment requirements indirectly affect station requirements.

The City plans for asset preservation through a capital maintenance program. Minor and major capital facility projects are included in the City's six-year Capital Improvement Plan (CIP).

Forecast of Future Needs

The City has added capacity and renovated or replaced many of the fire stations in the past ten years as part of the 2003 Fire Facilities levy, which provided about \$167 million to upgrade, renovate, or replace thirty-two neighborhood fire stations, construct a new training facility, and upgrade SFD's Fire Alarm Center, among other things. The new facilities have been built with excess physical capacity.

The City anticipates it will need to replace Fire Station No. 3 and the Fire Marshal office, and replace or expand the commissary and fire garage, as well as continue maintenance on the remaining existing buildings. To support existing operations, a new fire administration building and expanded training facilities are needed. To support SFD's desired goal of timely emergency response in all areas of the city, a new South Lake Union fire station and a fresh-water marine fire suppression facility are desired under existing conditions.

Capital Facilities Appendix Figure A-1

Map of SFD Facilities (Fire Stations)

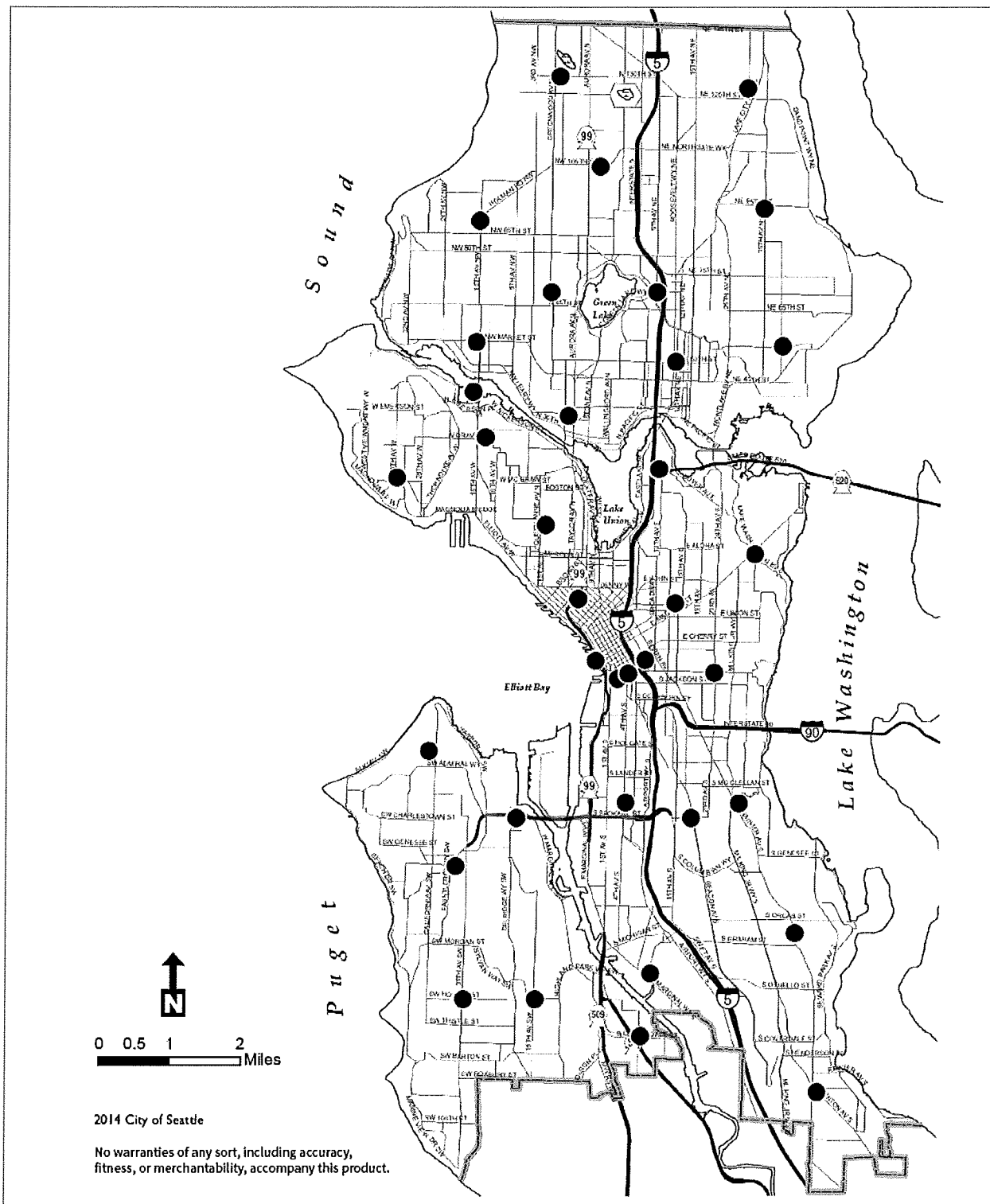

2014 City of Seattle

No warranties of any sort, including accuracy, fitness, or merchantability, accompany this product.

Capital Facilities Appendix Figure A-2

Table of SFD Facilities

Facility Name (* indicates an historic building)	Year Built/Updated	Size in Sq. Ft.	Area Served	Address
Headquarters*	1908	55,952	Citywide	301 2nd Avenue S
Fire Station 2*	1922 2010	37,740	Belltown	2334 4th Avenue
Fire Station 3	1960	2,760	Ballard	1735 W Thurman
Fire Station 5*	1963 2016	5,688	Waterfront	925 Alaskan Way
Fire Station 6	2013	11,003	Central District	405 Martin Luther King Jr. Way S
Fire Station 8	1964 2013	5,450	Queen Anne	110 Lee Street
Fire Station 9	2013	8,804	Fremont	3829 Linden Avenue N
Fire Station 10	2006	61,156	Int'l District	400 S Washington Street
Fire Alarm Control	2006	Portion of FS10	Citywide	105 5th Avenue S
Fire Station 11	1971 2015	5,610	Highland Park	1514 SW Holden Street
Fire Station 13*	1928 2012	4,329	Beacon Hill	3601 Beacon Avenue S
Fire Station 14*	1927 2013	16,831	SoDo District	3224 4th Avenue S
Fire Station 16*	1927 2013	3,995	Green Lake	6846 Oswego Pl. NE
Fire Station 17*	1929 2010	23,537	University	1020 NE 50th Street
Fire Station 18	1974 2015	16,624	Ballard	1521 NW Market Street
Fire Station 20	2014	6,229	Interbay	2800 15th Avenue W
Fire Station 21	2011	8,783	Greenwood	7304 Greenwood Avenue N

Facility Name (* indicates an historic building)	Year Built/ Updated	Size in Sq. Ft.	Area Served	Address
Fire Station 22	1965 2016	4,110	Roanoke	901 E Roanoke Street
Fire Station 24	1977 2014	3,630	Bitter Lake	401 N 130th Street
Fire Station 25	1969 2014	20,824	Capitol Hill	1300 E Pine Street
Fire Station 26	1970 2014	5,960	South Park	800 S Cloverdale Street
Fire Station 27	1970 2014	5,960	Georgetown	1000 S Myrtle Street
Fire Station 28	2010	13,638	Rainier Valley	5968 Rainer Avenue S
Fire Station 29	1970 2014	5,049	Admiral District	2139 Ferry Avenue SW
Fire Station 30	2011	9,100	Mount Baker	2931 S Mount Baker Blvd.
Fire Station 31	1974 2009	12,452	Northgate	1319 N Northgate Way
Fire Station 32	2016	6,646	West Seattle	3715 SW Alaska Street
Fire Station 33	1971 2010	5,061	Rainier Beach	9645 Renton Avenue S
Fire Station 34	2014	4,625	Madison Park	633 32nd Avenue E
Fire Station 35	2010	11,532	Crown Hill	8729 15th Avenue NW
Fire Station 36	1971 2014	4,676	Delridge/Harbor Island	3600 23rd Avenue SW
Fire Station 37	2010	9,000	West Seattle/High Point	7700 35th Avenue SW
Fire Station 38	2011	8,700	Hawthorne Hills	4004 NE 55th Street
Fire Station 39	2010	9,593	Lake City	2806 NE 127th Street
Fire Station 40	1965 2013	6,500	Wedgwood	9401 35th Avenue NE
Fire Station 41	1936 2010	6,146	Magnolia	2416 34th Avenue W
Fire Marshal	2000	9,462	Downtown	220 3rd Avenue S

Facility Name (* indicates an historic building)	Year Built/Updated	Size in Sq. Ft.	Area Served	Address
Training Facility	2009	53,402	Citywide	9401 Myers Way S
Commissary	1985	37,606	Citywide	3601 21nd Avenue S
Fire Garage	1975	15,000	Citywide	815 Dearborn Street
Harborview Medical Center		1,000	Citywide	325 9th Avenue
South Lake Union Station			South Lake Union	Not Determined

Police Department

Inventory

The Seattle Police Department (SPD) currently provides law enforcement patrol services to the city from five precincts and the Harbor Patrol Unit, which covers fifty-nine square miles of waterways. SPD also provides for parking and traffic enforcement as well as specialized units including SWAT, gang unit, mounted patrol, and canine. Information on these precincts and facilities is shown in Capital Facilities Appendix Figures A-3 and A-4.

Planning Goals

Uniform patrol law enforcement services are generally allocated based on workload, time, and location. The exact location of facilities is usually not critical to the provision of uniform patrol services since police officers are on patrol in the various sectors and calls for service are dispatched by radio. The location of facilities can be important because the distance traveled at shift change time impacts the availability of officers and because locations can enhance interaction with the community. Because of the many changing factors that affect staffing and space objectives of police departments, there are no universally accepted planning goals for the location and distribution of police facilities.

The City plans for asset preservation through a capital maintenance program. Minor and major capital facility projects are programmed in the City's six-year capital improvement program.

Forecast of Future Needs

The City is expected to maintain, replace, or expand some police facilities as shown in Capital Facilities Appendix Figure A-4. To support existing police operations citywide, SPD expects that it may upgrade, expand, or replace Harbor Patrol, rifle range, and training

facilities. The existing North Precinct is currently overcrowded and does not meet the needs of precinct personnel; therefore, a new consolidated facility is proposed to be built. The City has purchased property for a new North Precinct. In the next twenty-year period, the City may also elect to build its own correctional facility, rather than to continue leasing space from King County at its jail.

Capital Facilities Appendix Figure A-3
 Map of Current SPD Precinct Stations (Police Precincts)

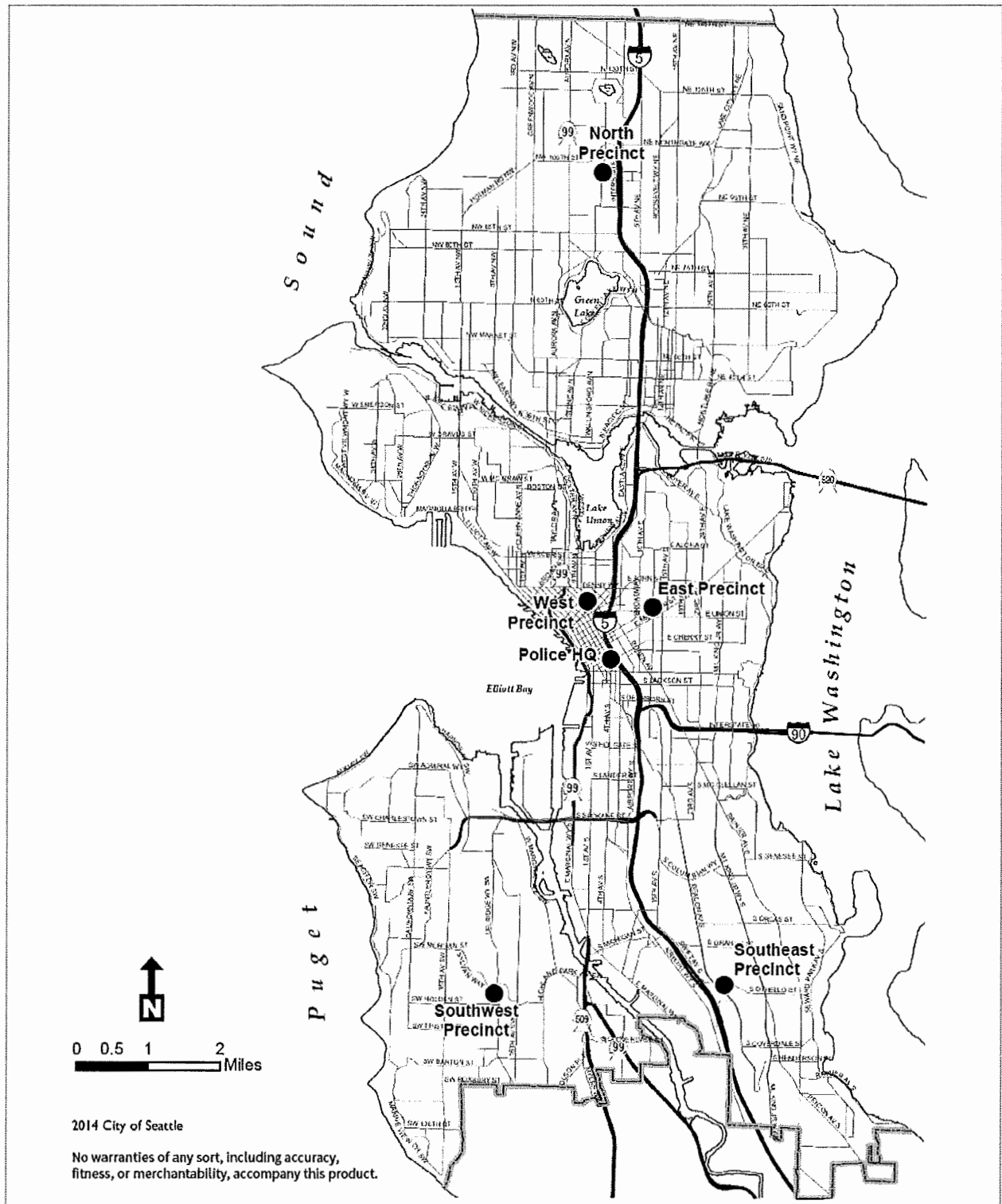

Capital Facilities Appendix Figure A-4

Table of Police Department Facilities

Facility Name	Year Built/Updated	Size in Sq. Ft.	Description	Area Served	Address
Police Headquarters	2002		Police Headquarters shares Justice Center building	Citywide	610 5th Avenue
Justice Center	2005	310,490	Justice Center includes municipal courts	Citywide	600 5th Avenue
Professional Accountability	1970	6,300	Leased space in Pacific Building	Citywide	712 3rd Avenue
North Precinct	1984	16,434	Serves area north of the Ship Canal to city limits	Northgate	10049 College Way N
Emergency Operations Center/911 Call center	2006	61,156	Shared facility with Fire Alarm Center and FS 10	Citywide	400 S Washington Street
North Precinct Annex	1983	4,474	Leased office space	Northgate	10303 Meridian Avenue N
West Precinct	1999	50,960	Serves Queen Anne, Magnolia, the Downtown core, and the area west of I-5	Downtown	810 Virginia Street
West Precinct Garage	1948	53,336	Condo garage located in adjacent building	Capitol Hill	2021 9th Avenue
East Precinct	1926 1985	61,580	Serves the area north of I-90 to the Ship Canal and east of I-5, Eastlake Community	East Precinct	1519 12th Avenue
East Precinct Garage	2014	29,058	Garage located under 12th Avenue Arts building	Capitol Hill	1624 12th Avenue
South Precinct	1983	13,688	Serves area south of I-90 to city limits and west of Duwamish	Beacon Hill	3001 S Myrtle Street
Southwest Precinct	2002	28,531	Serves West Seattle and Duwamish Industrial area	Delridge	2300 SW Webster
Mounted Patrol	2001	39,041	12 full-time horse stalls and related equipment	Citywide	9200 8th Avenue SW
Police Training Center			Practice range is an open-air range	Citywide	11026 E Marginal Way S

Facility Name	Year Built/Updated	Size in Sq. Ft.	Description	Area Served	Address
K-9 Kennel		6,464	Houses 6 dogs and 2 pups and related equipment and supplies	Citywide	11026 E Marginal Way S
SPD Parking Enforcement		10,268	Office and Warehouse (leased)	Northwest	1330 N 131st Street
Harbor Patrol	1928 1986	3,706	Offices, shops, docks, and maintenance buildings	Citywide	1717 Northlake Pl.
Warehouse		5,400	Vehicle storage	Citywide	923 S Bayview Street
Police Support Facility	1985	145,158	Airport Way Center Police Support Facility	Citywide	2203 Airport Way S
Warehouse		21,800	Storage	Citywide	4735 E Marginal Way S
Correctional Facilities	NA		City leases space from King County Jail	Citywide	

Parks and Recreation

Inventory

Seattle Parks and Recreation (Parks) manages a 6,200-acre park system, including 465 parks and extensive natural areas. Parks provides athletic fields, tennis courts, play areas, specialty gardens, and more than 25 miles of boulevards and 120 miles of trails. The system covers about 1.1 percent of the City of Seattle's land area. Parks also manages many facilities, including community centers, swimming pools, environment learning centers, small craft centers, golf courses, an outdoor stadium, skate parks, and more. Parks and open areas owned by the City and their respective capacities are shown in Capital Facilities Appendix Figures A-5 through A-7.

Capital Facilities Appendix Figure A-5

Table of Parks by Type

Park Type	Size of Facility
Boulevards/Green streets/Greenways	348 acres
Community Parks	606 acres

Park Type	Size of Facility
Downtown Parks	23 acres
Greenbelts/Natural Areas	1,285 acres
Mini Parks/Pocket Parks	58 acres
Neighborhood Parks	717 acres
Regional Parks/Large Urban Parks	1,446 acres
Special-Use Parks/Specialty Gardens	1,366 acres

Capital Facilities Appendix Figure A-6

Table of Recreational Facilities by Type

Number	Facility Type
26	Community centers
10	Swimming pools, including two outdoor pools
32	Wading pools and spray parks
1	Aquarium
1	Zoo, including 45 major exhibits, 145 buildings and structures on 92 acres
1	Stadium
1	Indoor tennis center
144	Outdoor tennis courts, 17 of which have lighting, plus two multi-use courts for dodgeball, bike polo, and roller hockey
207	Athletic fields, including 19 sites with synthetic fields and lighting
11	Skate parks, comprising district parks, skate spots, and skate dots
4	Golf courses, including three driving ranges and a pitch/putt facility
2	Rowing, sailing, and small craft centers
4	Environmental learning centers
6	Performing and visual art facilities
54	Landmarked buildings (overlaps with other categories, since some community centers, the Asian Art Museum, concessions, a bathhouse, and other structures are landmarked)
118	Comfort stations

Number	Facility Type
40	Rentable picnic shelters
20	Administrative offices and headquarters
2	Museums
5	Amphitheaters
90	Miscellaneous—storage, maintenance, warehouses

Capital Facilities Appendix Figure A-7

Map of Parks and Recreation Facilities

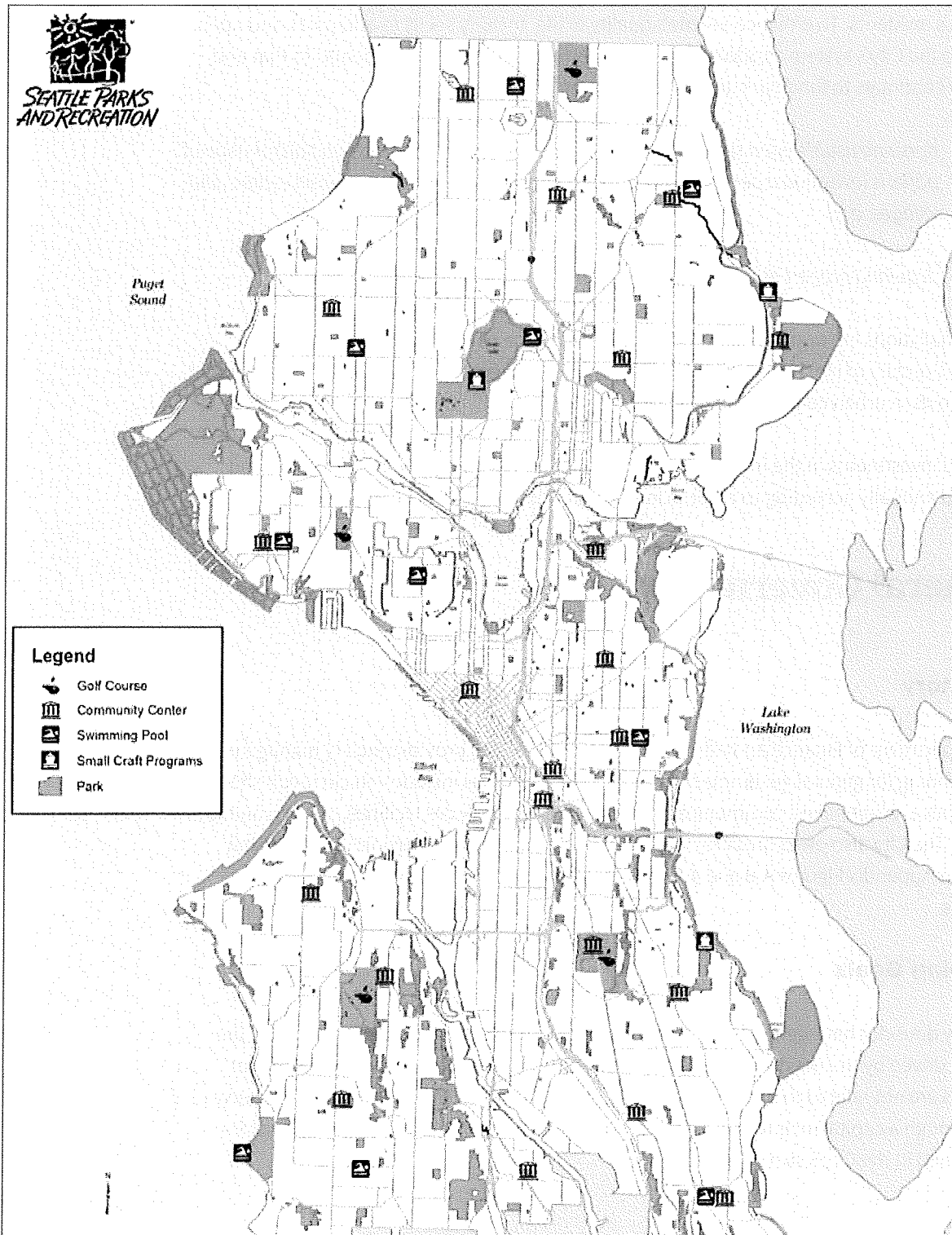

Forecast of Future Needs

The City has a robust citywide park system, which is available and accessible for use by all of the City's residents. To enhance Seattle's quality of life, the City seeks to add parks and open space to the City's system as additional amenities for all of the City's residents. To that end, the City continues to fund park acquisition with the primary goals of:

1. *pursuing usable open space acquisition in areas where the acreage and distribution of parks is lowest on a per capita basis. These are mostly found within urban centers and villages; and*
2. *acquiring properties that can complete or expand existing parks.*

Park acquisitions are opportunity-driven. Additions to the park facilities would enhance the City's quality of life. However, such additions are not necessary to accommodate new households in urban centers, urban villages, or citywide.

Planned investments in the maintenance of existing facilities are provided in the CIP and updated annually according to asset management priorities and available funds.

General Government

Inventory

The Department of Finance and Administrative Services (FAS) provides facility management and planning for general government facilities. These facilities include vehicle repair shops, office space, warehouses, communication facilities, social services facilities, and the animal shelter. The City also owns property that is leased to social service organizations. Capital Facilities Appendix Figures A-8 and A-9 show an inventory of existing general government facilities.

Planning Goals

The City does not have general planning goals for general government facilities, which are instead driven by the needs of specific departments and programs. These governmental facilities are not related to or necessary for future growth. The City plans for asset preservation through a capital maintenance program. Minor and major capital facility projects are programed in the City's six-year CIP.

Forecast of Future Needs

FAS has identified a need for expanded facilities that support vehicle maintenance and department operations over the twenty-year planning horizon. Additional warehouse and office space may be needed as the City grows; this need is driven primarily by budget revenue and departmental priorities. Additional space needs can be accommodated through leasing as well as building new space. General facilities that support citywide functions such as the animal shelter and Consumer Affairs need new and expanded facilities to enhance quality of life.

Capital Facilities Appendix Figure A-8

Map of General Government Facilities

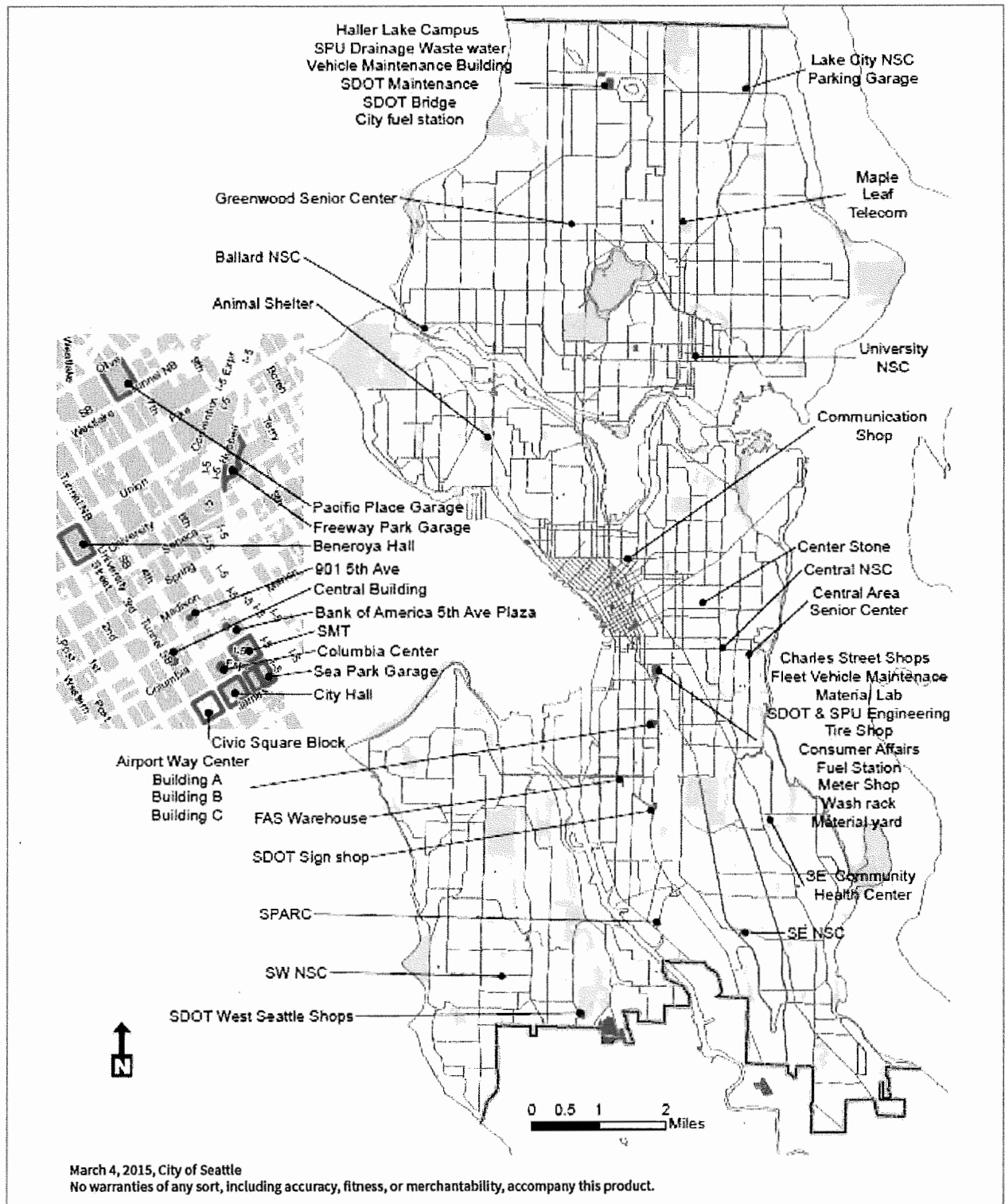

March 4, 2015, City of Seattle
 No warranties of any sort, including accuracy, fitness, or merchantability, accompany this product.

Capital Facilities Appendix Figure A-9

Table of General Government Facilities

Facility Name	Year Built /Updated	Size in Sq. Ft.	Description	Area Served	Address
Seattle Municipal Tower	1989	1,223,577	Administrative offices	Citywide	700 5th Avenue
SMT/Parking Garage	1989	193,891	SMT parking	Citywide	700 5th Avenue
City Hall	2003	153,502	Council and Mayor offices	Citywide	600 4th Avenue
Sea Park Garage	1993	213,346	Parking garage for City Campus	Downtown	609 6th Avenue
Columbia Center		9,294	Leased office	Citywide	400 4th Avenue
Central Building		28,523	Leased office	Citywide	810 3rd Avenue
Bank of America Building 5th Ave Plaza		42,578	Leased office	Citywide	800 5th Avenue
901 5th Ave Building		28,721	Leased office	Citywide	901 5th Avenue
Pacific Building		6,800	Leased office	Citywide	720 3rd Avenue
FAS Warehouse		21,898	Records and surplus	Citywide	3807 2nd Avenue
Airport Way Center Bldg. A	1944 1981	102,075	Office building	Citywide	2203 Airport Way S
Airport Way Center Bldg. B	1985	16,800	FAS shop space	Citywide	2203 Airport Way S
Airport Way Center Bldg. D	1985	22,803	FAS paint shops	Citywide	2203 Airport Way S
Seattle Animal Shelter	1981	1,567	Animal shelter and spay and neuter clinic	Citywide	2189 15th Avenue W
	1956	5,122	SDOT Street Maintenance	Citywide	9200 8th Avenue SW
West Seattle Shops	1980	1,200	SDOT Urban Forestry trailer	Citywide	9200 8th Avenue SW

Facility Name	Year Built /Updated	Size in Sq. Ft.	Description	Area Served	Address
Haller Lake Campus	1975	2,436	SPU Drainage Waste Water buildings	North	12600 Stone Avenue N
	1958	24,588	Vehicle Maintenance Building A	North	12555 Ashworth Avenue N
	1998	5,979	SPU Hazardous Waste buildings	North	12550 Stone Avenue N
	1996	6,725	SDOT Street Maintenance Building B	North	12599 Ashworth Avenue N
	1973	3,640	SDOT equipment storage	North	12535 Ashworth Avenue N
	1973	3,724	SDOT bridge maintenance and paint shop buildings	Citywide	1328 & 1324 N 125th Street
	1975	1,991	Fuel station	North	12600 Stone Avenue N
Charles Street Campus	1950 2008	67,356	Fleet Vehicle Maintenance	Citywide	805 Charles Street
	1973	7,400	Materials Testing Lab (SPU)	Citywide	707 S Plummer
	1974	21,315	SPU and SDOT Engineering	Citywide	714 Charles Street
	1967	5,450	Fleet Tire Shop	Citywide	814 8th Avenue S
	1950	1,624	Weights and Measures	Citywide	805 Charles Street
		2,000	Equipment wash rack	Citywide	1011 8th Avenue S
	1994	200	Fuel station	Citywide	1040 7th Avenue S
	1967	22,058	Meter Shop, bridges	Citywide	1010 8th Avenue
	1960	20,000	Material yard	Citywide	717 S Plummer Street
	1960	185,046	Yard and parking	Citywide	1099 S Airport Way
SDOT Sign Shop	1960 1970	45,036	SDOT Sign Shop	Citywide	4200 Airport Way S
DOIT Com. Shop	1951	4,964	Communications Shop	Denny Triangle	1933 Minor Avenue
NE Telecom Building	2014	6,000	Communications building	Northeast	8526 Roosevelt Way NE

Facility Name	Year Built /Updated	Size in Sq. Ft.	Description	Area Served	Address
Ballard Service Center	2005	3,100	Neighborhood Service Center	Ballard	5604 22nd Avenue NW
Lake City Service Center and Garage	2005	12,409	Neighborhood Service Center and parking garage	Lake City	12525 & 12509 28th Avenue NE
Central Service Center	1980	2,235	Central Area Service Center	Central	2301 S Jackson Street
SW Service Center	1975	400	Neighborhood Service Center	Junction	2801 SW Thistle Street
SE Service Center	2003	1,500	SE Neighborhood Services Center	Southeast	3815 S Othello Street
University Service Center		1,400	University Neighborhood Service Center	University	4534 University
Pacific Place Garage	1999	526,850	Condo ownership of garage portion of Pacific Place	Downtown	600 Pine Street
Freeway Park Garage	1975	63,750	Leased to Washington State Convention Center	Downtown	609 9th Avenue
Central Area Senior Center	1959	9,478	Central Area Senior Center	Central	500 30th Avenue S
Greenwood Senior Center	1950	9,587	Greenwood Senior Center	Greenwood	525 N 85th Street
Northwest Senior Center	1950	8,400	Northwest Senior Center	Ballard	5431 32nd Avenue NW
Center Stone	1908	15,360	Lease to social services agency	Central	722 18th Avenue
SPARC	1919	5,848	South Park Community Center	South Park	8201 10th Avenue S
Benaroya Hall			Ground lease	Citywide	200 University

Public Library

Inventory

The Seattle Public Library (SPL) operates the Central Downtown Library, twenty-six neighborhood libraries, and a fleet of four bookmobiles. The State-funded Washington Talking Book and Braille Library (WTBBL) is also administered by SPL. SPL rents space for three facilities it does not own. Capital Facilities Appendix Figures A-10 and A-11 show SPL facilities.

Planning Goals

In 2009, SPL completed a decade of building renewal and expansion. The voter-approved Libraries for All capital program renovated or replaced all twenty-two branches that were in the system as of 1998, added four new branch libraries, and built the new Central Library. The expansion also allowed for an increase in the number of public access computers, large community meeting areas, and study rooms. The focus has shifted from buildings to services as provided in the 2011 Library Strategic Plan.

Forecast of Future Needs

The Seattle Public Library will need maintenance and support facilities to support the existing library facilities.

Capital Facilities Appendix Figure A-10

Map of Library Facilities

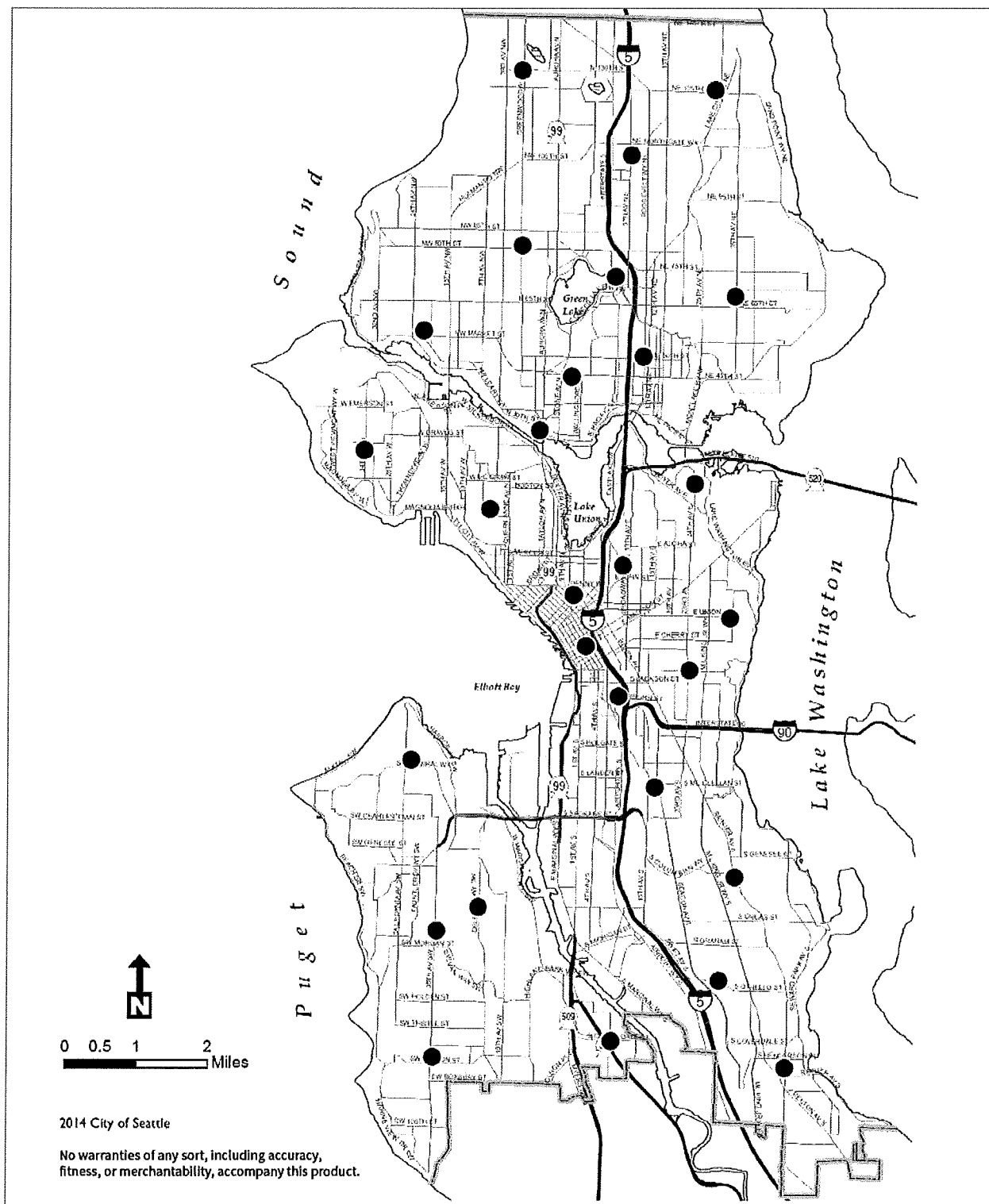

Capital Facilities Appendix Figure A-11

Table of Library Facilities

Branch Name	Address	Size in Sq. Ft.
Ballard	5711 24th Avenue NW	7,296
Beacon Hill	2519 15th Avenue S	10,800
Broadview	12755 Greenwood Avenue N	8,405
Capitol Hill	425 Harvard Avenue E	11,615
Central	1000 4th Avenue	363,000
Columbia*	4721 Rainier Avenue S	12,420
Delridge	5423 Delridge Way SW	5,600
Douglass-Truth*	2300 E Yesler	8,008
Fremont*	731 N 35th Street	6,060
Green Lake*	7364 E Green Lake Dr. N	8,090
Greenwood	8016 Greenwood Avenue N	7,085
High Point	6302 35th Avenue SW	7,000
Lake City*	12501 28th Avenue NE	9,013
Madrona-Sally Goldmark‡	1134 33rd Avenue	1,701
Magnolia*	2801 34th Avenue W	5,859
Mobile Services	2025 9th Avenue	5,056
Montlake	2300 24th Avenue E	1,574
New Holly	7058 32nd Avenue S	4,000
Northeast*	6801 35th Avenue NE	15,000
Queen Anne*	400 W Garfield Street	7,931
Rainier Beach	9125 Rainier Avenue S	15,000
Southwest	9010 35th Avenue SW	7,557
University*	5009 Roosevelt Way NE	8,104
Wallingford	1501 N 45th Street	2,000
Wash. Talking Book and Braille Library‡	2021 9th Avenue	10,000

Branch Name	Address	Size in Sq. Ft.
West Seattle*	2306 42nd Avenue SW	8,970

*City of Seattle Landmark or located in City landmark/special review district
 ‡City historic resource survey properties

Seattle Center

Inventory (See Capital Facilities Appendix Figure A-12)

Seattle Center serves as an extraordinary arts, civic, and public family gathering place for our region, located on a seventy-four-acre campus in the middle of the Seattle urban core. Over thirty cultural, educational, sports, and entertainment resident organizations at Seattle Center, together with a broad range of public and community programs, offer 5,000 events attracting twelve million visits each year. Seattle Center’s purpose is “to create exceptional events, experiences, and environments that delight and inspire the human spirit to build stronger communities.” Seattle Center activities generate \$1.15 billion of business activity and \$387 million of labor income a year.

The center is home to twelve theater spaces ranging in capacity from 200 seats in the Center Theatre to 2,900 at Marion Oliver McCaw Hall and totaling nearly 6,000 seats for theatrical performances. Sports facilities include the Key Arena with a capacity of 17,000 and Memorial Stadium with a capacity of 12,000 for field events. There are three schools on the campus—a ballet school, a school for 3-D animation and gaming, and a public high school. There are ten fountains on the grounds and approximately 40 acres of landscaped and green open space and pedestrian ways. There are also active outdoor spaces, including a children’s playground and a skate park. Seattle Center’s outdoor open spaces, gardens, and fountains are a major urban oasis for active or passive and individual or group enjoyment.

The center owns and manages two surface parking lots and three parking garages totaling more than 3,500 spaces. The center is served by multiple King County Metro bus routes and by the Monorail, which runs between Downtown and Seattle Center and carries more than 2 million riders a year over a 0.9-mile route.

Notable buildings and facilities on the Seattle Center campus include: KEXP; Seattle Center Armory; Key Arena; the Space Needle; International Fountain; Chihuly Garden and Glass; Experience Music Project; Memorial Stadium; Pacific Science Center; KCTS; McCaw Hall; Phelps Center and Ballet School; Seattle Children’s Theatre; Seattle Repertory Theatre; Seattle Children’s Museum; Fisher Pavilion; SIFF Film Center; The VERA Project; Pottery Northwest; the Northwest Rooms; Center Playground; Mercer Arena, and the Seattle Center Pavilion.

Capital Facilities Appendix Figure A-12

Table of Seattle Center Facilities

Facility	Address	Size in Sq. Ft.
Armory (formerly Center House)	305 Harrison Street	278,500
Blue Spruce	158 Thomas Street	14,036
Central Plant	324 Republican Street	10,072
Chihuly Garden and Glass	305 Harrison Street	30,000
EMP	200 2nd Avenue N	283,324
Exhibition Hall	225 Mercer	52,000
Fifth Avenue N Garage	516 Harrison Street	356,390
First Avenue N Garage	220 First Avenue N	173,000
Fisher Pavilion	200 Thomas Street	21,018
International Fountain		122,000
International Fountain Pavilion	2nd Avenue N & Republican Street	4,681
KCTS	401 Mercer Street	
Key Arena	334 First Avenue N	368,000
Kobe Bellhouse		600
Maintenance Shop—Leased (5.5 Building)	621 2nd Avenue N	30,720
Marion Oliver McCaw Hall	321 Mercer Street	295,000
Memorial Stadium		238,920
Memorial Stadium Parking Lot		101,489
Mercer Arena	363 Mercer Street	108,000
Mercer Street Garage	300 Mercer Street	511,424
Monorail Office and Gift Shop	370 Thomas Street	4,592
Monorail Terminal		19,563
Mural Stage		3,200
NASA Building	102 Thomas Street	8,400
Next 50 Pavilion		5,285

Facility	Address	Size in Sq. Ft.
Northwest Rooms	354 First Avenue N	35,240
Pacific Science Center		141,681
Park Place	232 First Avenue N	7,200
Phelps Center/Pacific NW Ballet	225 Mercer Street	49,680
Playhouse Theatre (without courtyard)	201 Mercer Street	33,424
Playhouse Theatre Rehearsal Hall		4,333
Pottery Northwest	226 First Avenue N	7,200
Restroom Pavilion	303 2nd Avenue N.	1,219
Seattle Center Pavilion		7,580
Seattle Center Skatepark		18,825
Seattle Center Warehouse (under N. Stadium Stands)	369 Republican Street	20,774
Seattle Children's Theatre	240 Thomas Street	46,300
Seattle Children's Theatre Tech Pavilion		29,112
Seattle Repertory Theatre	151 Mercer Street	65,000
SIFF (Seattle International Film Festival)		11,776
Space Needle		4,400
The Vera Project		9,536
West Court Building	312 First Avenue N	10,596

Seattle Public Schools

Inventory

Public schools in Seattle are owned and operated by the Seattle school district. As of October 2015, 53,872 students are enrolled in Seattle Public Schools (SPS), in ninety-eight facilities (including twelve high schools, ten middle schools, ten K-8 schools, six service schools, and sixty elementary schools). In addition, SPS has 18 sites with closed or vacated school sites and has reactivation plans for some of these. SPS also owns various athletic, administrative, and support buildings. Existing school locations are shown

in Capital Facilities Appendix Figure A-13. (<https://www.seattleschools.org/cms/one.aspx?portalId=627&pageId=665322>)

Facilities Master Plan and Forecast of Future Needs

Capital facility planning is driven by a number of factors, including projected student population, curriculum goals, educational specifications (including classroom size and necessary facilities), and specialized needs of specific students.

The **SPS 2012 Facilities Master Plan** is the latest plan. It provides planning information for a period of ten years through school year 2021–22. The plan guides future facilities improvements based on a needs analysis at the level of individual school service area. According to the 2012 plan, by 2022, over 57,000 students are projected to attend schools that have a present capacity of approximately 51,700. A facilities prioritization plan was adopted in 2015.

Strategies to Address Future Needs

For the majority of funding for facility construction and renovation, SPS relies on two voter-approved capital levies. These run on alternating six-year schedules and are called Building Excellence (BEX) and Buildings, Technology and Academics (BTA). BEX funds the renovation and replacement of schools, and BTA provides capital monies to repair existing building envelopes, replace roofs, improve mechanical/electrical/life-safety systems, and provide technology improvements.

Because capacity management continues to be an SPS priority, BEX and BTA help fund strategies to address capacity needs. These strategies include repurposing existing spaces, opening new schools, and adding portables. For example, some preschools are being reopened, as is Lincoln High School. BTA IV was approved by Seattle voters in February 2016. It will provide funding for capacity improvements to four elementary schools, two middle schools, and one high school. Future BEX and BTA levies are planned through 2037, consistent with the 2035 horizon year of this Comprehensive Plan.

Public Health

Public Health—Seattle & King County (Public Health) is a joint enterprise of the City of Seattle and King County and is responsible for the supervision and control of all public health and sanitation affairs in Seattle and King County. Public Health maintains a system of personal health, environmental health, health promotion, and disease prevention services through health centers/clinics and other service sites located in Seattle. The capacity and ownership of individual facilities are listed below.

Capital Facilities Appendix Figure A-14

Table of Public Health Facilities

Health Facility	Size in Sq. Ft.	Tenancy
Chinook Building (Administration)	114,839	Owned
Columbia Health Center	28,094	Owned
Downtown Clinic	25,497	Leased
Harborview: STD Clinic	13,197	Owned
Harborview: Medical Examiner	34,147	Owned
Harborview: Public Health Laboratory	5,003	Owned
Harborview: TB Clinic	4,205	Owned
Lake City Dental Clinic	3,370	Leased
North District Health Center*	16,067	Owned
Rainier Beach Teen Clinic	800	Leased

*Scheduled for demolition in 2016

Facilities Serving Urban Centers

Following is an inventory of facilities that serve urban centers. Facilities do not have to be located within the boundaries or potential boundaries of the centers or villages in order to serve those areas.

Downtown Urban Center

Facility Type	Name	Location
Fire Station	Headquarters	301 2nd Avenue S
Fire Station	Fire Station 5	925 Alaskan Way
Fire Station	Fire Station 2	2334 4th Avenue
Fire Station	Fire Station 25	1300 E Pine Street
Police Station	East Precinct	1519 12th Avenue
Library	Central Library	1000 4th Avenue
Park	Alaskan Way Boulevard	Alaskan Way Blvd.
Park	Bell Street Boulevard	Bell Street Blvd. from 1st Avenue to 5th Avenue
Park	Belltown Cottages	2520 Elliott Avenue
Park	Boren-Pike-Pine Park	Boren Avenue & Pike Street
Park	City Hall Park	450 3rd Avenue
Park	Denny Park	100 Dexter Avenue
Park	Denny Playfield	Westlake Avenue & Denny Way
Park	Dr. Jose Rizal Park	1008 12th Avenue S
Park	East Duwamish Greenbelt	2799 12th Avenue S
Park	Freeway Park	700 Seneca Street
Park	Harborview Park	778 Alder Street
Park	Hing Hay Park	423 Maynard Avenue S
Park	Int'l Children's Park	700 S Lane Street
Park	Kobe Terrace	221 6th Avenue S
Park	McGraw Square	Stewart Street & Westlake Avenue N
Park	Myrtle Edwards Park	3130 Alaskan Way W
Park	Occidental Square	Occidental Avenue S & S Main Street
Park	Plymouth Pillars Park	Boren Avenue & Pike Street
Park	Piers 62 and 63	1951 Alaska Way
Park	Pioneer Square	100 Yesler Way

Facility Type	Name	Location
Park	Prefontaine Place	3rd Avenue & Yesler Way
Park	Regrade Park	2251 3rd Avenue
Park	Seattle Aquarium	Pier 59
Park	Seattle Center	Denny Way & Republican Street (1st Avenue N to 5th Avenue N)
Park	Sturgus Park	904 Sturgus Avenue S
Park	Tillicum Place	5th Avenue & Denny Way
Park	Union Station Square	Jackson & 3rd Avenue S
Park	Victor Steinbrueck Park	2001 Western Avenue
Park	Waterfront Park	1301 Alaskan Way
Park	Westlake Park	401 Pine Street
Park	Westlake Square	1900 Westlake Avenue N
Park	Yesler Terrace Community Center grounds	Yesler Way & Broadway Avenue
	Gatzert and Lowell Elementary Schools	
Schools	McClure and Washington Middle Schools	
	Garfield High School	

Overall, City facilities are sufficient to accommodate expected twenty-year growth.

A replacement of the Fire Department’s headquarters building is expected for reasons other than as a result of development (the SFD headquarters is located in the urban center).

The City may seek to increase park space in the urban center to meet desired goals. While additions to the park facilities would enhance the City’s quality of life, such additions are not necessary to accommodate new households in urban centers or citywide.

Some of the schools serving this urban center are projected to exceed their capacity, given existing attendance area boundaries and other factors. Given that Seattle Public Schools has planned investments to meet citywide capacity needs, capacity issues could potentially be solved by modifying attendance area boundaries, allowing more students to transfer to other schools, or other strategies. Seattle Public Schools is also evaluating the creation of a Downtown elementary school. This could help create a local school option as well as assist with capacity issues.



First Hill/Capitol Hill Urban Center

Facility Type	Name	Location
Fire Station	Fire Station 25	1300 E Pine Street
Fire Station	Fire Station 10	301 2nd Avenue S
Fire Station	Fire Station 22	901 E Roanoke Street
Fire Station	Fire Station 6	101 23rd Avenue S
Library	Capitol Hill Branch	425 Harvard Avenue E
Library	Central Library	1000 4th Avenue
Library	Douglass Truth Branch	2300 E Yesler Way
Community Center	Yesler Playfield & Community Center	903 Yesler Way
Park	12th & E James Street Park	12th Avenue & E James Street
Park	Bellevue Place	Bellevue Pl. E & Bellevue Avenue E
Park	Belmont Place	Belmont Pl. E & Belmont Avenue E
Park	Boren Place	Broadway & Boren Avenue S
Park	Boren-Pike-Pine Park	Boren Avenue & Pike Street
Park	Boylston Place	Broadway Avenue & Boylston Avenue E
Park	Cal Anderson Park	1635 11th Avenue
Park	Federal & Republican	Federal Avenue & Republican Street
Park	First Hill Park	University Street & Minor Avenue E
Park	Freeway Park	700 Seneca Street
Park	Harborview Park	778 Alder Street
Park	Horiuchi Park	156 Boren Avenue
Park	Kobe Terrace	221 6th Avenue S
Park	McGilvra Place	E Madison Street & Pike Street
Park	Miller Playfield	400 19th Avenue E
Park	Plymouth Pillars	Boren Avenue & Pike Street
Park	Seven Hills	1514 E Howell Street
Park	Spring Street Mini Park	E Spring Street & 15th Avenue

Facility Type	Name	Location
Park	Spruce & Squire Park	156 Boren Avenue
Park	Summit Place	Belmont Avenue E & Bellevue Pl. E
Park	Tashkent Park	511 Boylston Avenue
Park	Thomas Street Mini Park	306 Bellevue Avenue E
Park	Volunteer Park	1247 15th Avenue E
Park	Volunteer Parkway	14th Avenue E (E Prospect Street to E Roy Street)
Park	Williams Place	15th Avenue E & E John Street
Police Station	East Precinct	1519 12th Avenue
	Gatzert, Lowell, Madrona, and Stevens Elementary Schools	
Schools	Meany and Washington Middle Schools	
	Garfield High School	

Overall, City facilities are sufficient to accommodate expected twenty-year growth. The City may seek to increase park space in the urban center to meet desired goals. While additions to the park facilities would enhance the City's quality of life, such additions are not necessary to accommodate new households in urban centers or citywide.

Some of the schools serving this urban center are projected to exceed their capacity, given existing attendance area boundaries and other factors. Meany Middle School is proposed to be reconfigured to accommodate more students. Given that Seattle Public Schools has planned investments to meet citywide capacity needs, capacity issues could potentially be solved by the Meany reconfiguration and modifying attendance area boundaries, by allowing more students to transfer to other schools, or by other strategies. Seattle Public Schools is also evaluating the creation of a Downtown elementary school. This could help create a local school option as well as assisting with capacity issues.

University Community Urban Center

Facility Type	Name	Location
Fire Station	SFD 17	1050 NE 50th Street
Fire Station	SFD 38	5503 33rd Avenue NE
Library	Northeast Branch	6801 35th Avenue NE
Library	University Branch	5009 Roosevelt Way NE
Park	17th Ave NE Centerstrip	17th Avenue NE (NE 45th Street to NE Ravenna Blvd.)

Facility Type	Name	Location
Park	Burke-Gilman Trail	8th Avenue NW to NE 145th Street
Park	Christie Park	NE 43rd Street & 9th Avenue NE
Park	Cowen Park	5849 15th Avenue NE
Park	North Passage Point Park	600 NE Northlake Way
Park	Ravenna Boulevard	NE Ravenna Blvd. (E Green Lake Way N to 20th Avenue NE)
Park	Ravenna Park	5520 Ravenna Avenue NE
Park	University Heights	University Way NE & NE 50th Street
Park	University Playground	9th Avenue NE & NE 50th Street
Police Station	North Precinct	10049 College Way N
	Greenlake and Bryant Elementary Schools	
Schools	Eckstein and Hamilton Middle Schools	
	Roosevelt High School	

Overall, City facilities are sufficient to accommodate expected twenty-year growth. Construction of a new north precinct is planned to deal with existing overcrowding.

Some of the schools serving this urban center are projected to exceed their capacity given existing attendance area boundaries and other factors. Given that Seattle Public Schools has planned investments to meet citywide capacity needs, capacity issues could potentially be solved by modifying attendance area boundaries, by allowing more students to transfer to other schools, or by other strategies.

Northgate Urban Center

Facility Type	Name	Location
Fire Station	Fire Station 31	1319 N Northgate Way
Police Station	North Precinct	10049 College Way N
	Olympic View Elementary	
Schools	Jane Addams Middle School	
	Nathan Hale High School	
Library	Lake City Branch	12501 28th Avenue NE

Facility Type	Name	Location
Park	Hubbard Homestead Park	11203 5th Avenue NE
Park	Mineral Springs Park	10556 Meridian Avenue N
Park	Northgate Park	10510 5th Avenue NE
Park	Thornton Creek Park #6	5th Avenue NE & NE 103rd Street & Roosevelt Way NE & NE 107th Street
Park	Victory Creek Park	1059 Northgate Way

Overall, City facilities are sufficient to accommodate expected twenty-year growth. Construction of a new north precinct is planned to deal with existing overcrowding.

Some of the schools serving this urban center are projected to exceed their capacity given existing attendance area boundaries and other factors. Seattle Public Schools is developing a new Wilson Pacific Elementary school nearby this area. While the school is not planned to serve this urban center directly, its development will directly increase local capacity. Given that Seattle Public Schools has planned investments to meet citywide capacity needs, capacity issues could potentially be solved by modifying attendance area boundaries, by allowing more students to transfer to other schools, or by other strategies.

South Lake Union Urban Center

Facility Type	Name	Location
Fire Station	Fire Station 2	2334 4th Avenue
Fire Station	Fire Station 22	901 E Roanoke Street
Police Station	East Precinct	1519 12th Avenue
Police Station	West Precinct	810 Virginia Street
Library	Capitol Hill Branch	425 Harvard Avenue E
Library	Central Library	1000 4th Avenue
Park	Cascade Playground	333 Pontius Avenue N
Park	Denny Park	Westlake Avenue & Denny Way
Park	Denny Playfield	Westlake Avenue & Denny Way
Park	Eastlake Triangle	Eastlake Avenue E & E Prospect Street
Park	Fairview Walkway	Fairview Avenue N & E Galer Street
Park	South Lake Union Parks	1000 Valley Street

Facility Type	Name	Location
Park	Bellevue Place	Bellevue Pl. E & Bellevue Avenue E
Park	NE Queen Anne Greenbelt	1920 Taylor Avenue N
	Lowell Elementary School	
Schools	McClure Middle School	
	Garfield and Ballard High Schools	

Overall, City facilities are sufficient to accommodate expected twenty-year growth. To support the SFD's desired goal of timely emergency response in all areas of the city, a new South Lake Union fire station is needed under existing conditions.

Some of the schools serving this urban center are projected to exceed their capacity given existing attendance area boundaries and other factors. Given that Seattle Public Schools has planned investments to meet citywide capacity needs, capacity issues could potentially be solved by modifying attendance area boundaries, by allowing more students to transfer to other schools, or by other strategies. Seattle Public Schools is also evaluating the creation of a Downtown elementary school. This could help create a local school option as well as assisting with capacity issues.

Uptown Urban Center

Facility Type	Name	Location
Fire Station	Fire Station 8	110 Lee Street
Fire Station	Fire Station 2	2334 4th Avenue
Police Station	West Precinct	810 Virginia Street
Library	Queen Anne Branch	400 W Garfield
Library	Central Library	1000 4th Avenue
Community Center	Queen Anne Community Center	1901 1st Avenue W
Park	Alaskan Way Boulevard	Alaskan Way Blvd.
Park	Counterbalance Park	Queen Anne Avenue N & Roy Street
Park	Elliott Bay Park	Pier 86
Park	Kinnear Park	899 W Olympic Pl.
Park	Bhy Kracke	1215 5th Avenue N
Park	Kerry Park	211 W Highland Dr.

Facility Type	Name	Location
Park	Myrtle Edwards Park	3130 Alaskan Way W
Park	Northeast Queen Anne Greenbelt	1920 Taylor Avenue N
Park	Seattle Center	Denny Way & Republican Street (1st Avenue N to 5th Avenue N)
Park	SW Queen Anne Greenbelt	W Howe Street & 12th Avenue W
Park	Ward Springs Park	Ward Street & 4th Avenue N
	Hay Elementary School	
Schools	McClure Middle School	
	Ballard High School	

Overall, City facilities are sufficient to accommodate expected twenty-year growth.

Some of the schools serving this urban center are projected to exceed their capacity given existing attendance area boundaries and other factors. Given that Seattle Public Schools has planned investments to meet citywide capacity needs, capacity issues could potentially be solved by modifying attendance area boundaries, by allowing more students to transfer to other schools, or by other strategies. Seattle Public Schools is also evaluating the creation of a Downtown elementary school. This school could help create a local school option as well as assisting with capacity issues.

Potential Future Discretionary Projects

Besides the facilities in the City's CIP, there are a number of prospective capital projects that the City might undertake or fund in the future. They are listed below to provide a broad view of the City's potential future capital spending. Projects are not listed in any priority order. Funding for these projects may not yet be identified and decisions may not yet have been made to go forward with funding these projects.

Fire

- *South Lake Union Fire Station development*
- *Freshwater Marine Station relocation*
- *Fire Administration Building relocation*
- *Fire Marshal's Office relocation*
- *Warehouse Space replacement*
- *Training Facilities expansion*

Police

- *North Police Precinct replacement*
- *Harbor Patrol Building replacement*
- *Parking Enforcement facilities*
- *Police Training Center*
- *Municipal Correctional Facility*
- *Airport Way Center parking expansion*

General Facilities

- *City building maintenance facilities upgrades*
- *City vehicle maintenance facilities replacement*
- *Animal Shelter replacement*
- *Weights and Measures building replacement*
- *Communications Shop relocation*
- *Consumer Protection Division facility upgrades*
- *Office space consolidation*
- *Social Services facilities*
- *Civic Square development*
- *Energy efficiency improvements*
- *Urban Forestry facilities expansion*
- *Roadway Structures facility consolidation*
- *Street Maintenance facility improvements*
- *Streetcar Maintenance facility improvements*
- *BNSF property acquisition at SDOT sign shop*
- *Material storage facilities*

Seattle Center

- *Blue Spruce site redevelopment*
- *Memorial Stadium relocation**
- *Memorial Stadium site redevelopment*
- *Key Arena enhancement*
- *North Parking Lots redevelopment*

Parks

- *Seattle Aquarium Master Plan implementation*
- *Washington Park Arboretum improvements*
- *Downtown parks improvements*
- *Warren G. Magnuson Park building and site improvements*

- *Seattle Park District implementation*
- *Regional and neighborhood park improvements*
- *Waterfront improvements*

Library

- *Facility shops relocation*

(At the time of publication, project with an * is owned or sponsored by another government agency or private organization. The City might participate in funding this project.)



Utilities Appendix

City Utilities: Inventory, Capacity, and Future Needs Assessment

Seattle City Light: Electricity

Seattle City Light (SCL) is the City-owned electric utility serving all of Seattle and some portions of other cities and unincorporated King County north and south of the city limits.

Seattle City Light: Inventory & Capacity

SCL supplies power from a portfolio of sources that includes self-generated assets and purchased power. SCL typically purchases 50 percent of all power delivered to its customers. Utilities Appendix Figure A-1. below shows the sources of power.

Utilities Appendix Figure A-1

Sources of Electrical Generation

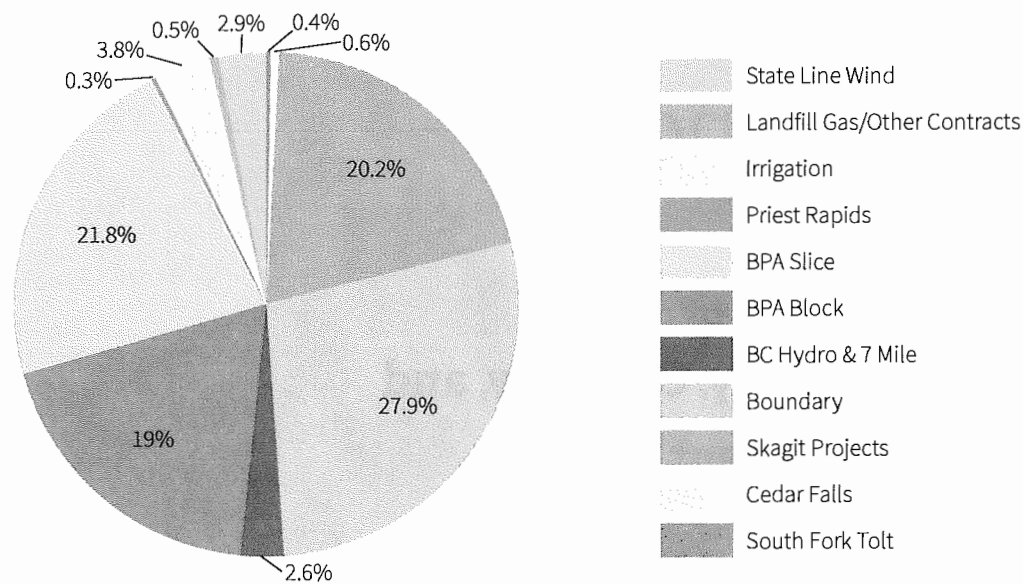

Owned Generation: 49.1% Treaty: 2.6% BPA: 40.8% Purchased Generation: 7.5%

Source: City Light, 2015

The current resource portfolio includes SCL-owned generation resources; long-term contract resources supplemented with power exchange agreements, near-term purchases, and sales made in the wholesale power market; and conservation. City Light-owned generation facilities include the Boundary Project, on the Pend Oreille River in northeast Washington, and the Skagit Project, which consists of three hydroelectric dams (Ross, Diablo, and Gorge) on the Skagit River. The Newhalem Hydroelectric Plant on Newhalem Creek, the Cedar Falls Dam on the Cedar River, and the South Fork Tolt Dam on the South Fork Tolt River are also smaller generating facilities owned by SCL.

In addition to these power sources, SCL purchases power from a variety of other sources including:

- *the Bonneville Power Administration (BPA), including firm amounts under the Block Product and a share in the output from the Federal System (Slice Product), which depends on water conditions*
- *British Columbia Hydro*
- *Lucy Peak, a hydro project located near Boise, Idaho*
- *Priest Rapids, a hydro project within the Grant County Public Utility District*

- *Grand Coulee Project Hydroelectric Authority, a share in the State Line Wind Project located in Southeast Washington and Northeast Oregon*
- *Biomass and landfill gas through Burlington Biomass, Columbia Ridge Landfill Gas Project, and King County West Point Wastewater Treatment Plant.*

Under an exchange agreement with the Northern California Power Agency, City Light delivers energy to NCPA in the summer and in exchange NCPA delivers energy to City Light in the winter.

SCL owns and maintains approximately 657 miles of transmission lines, which carry power from the Skagit and Cedar Falls generating facilities to fourteen principal substations. SCL is dependent on other transmission line owners, i.e., the Bonneville Power Administration (BPA), to bring power from its Boundary Dam hydroelectric plant and from other contracted resources, to serve its load in Seattle. The transmission grid interconnection with other utilities also provides additional reliability to meet load requirements. Power is distributed from SCL's principal substations via high voltage feeder lines to numerous smaller distribution substations and pole transformers, which reduce voltage to required levels for customers. SCL owns and maintains 2,428 circuit miles of distribution lines within Seattle that deliver power from the fourteen principal substations to approximately 365,200 customers (*see Utilities Appendix Figures A-2 and A-3*).

Utilities Appendix Figure A-2

Electrical Generation Resources

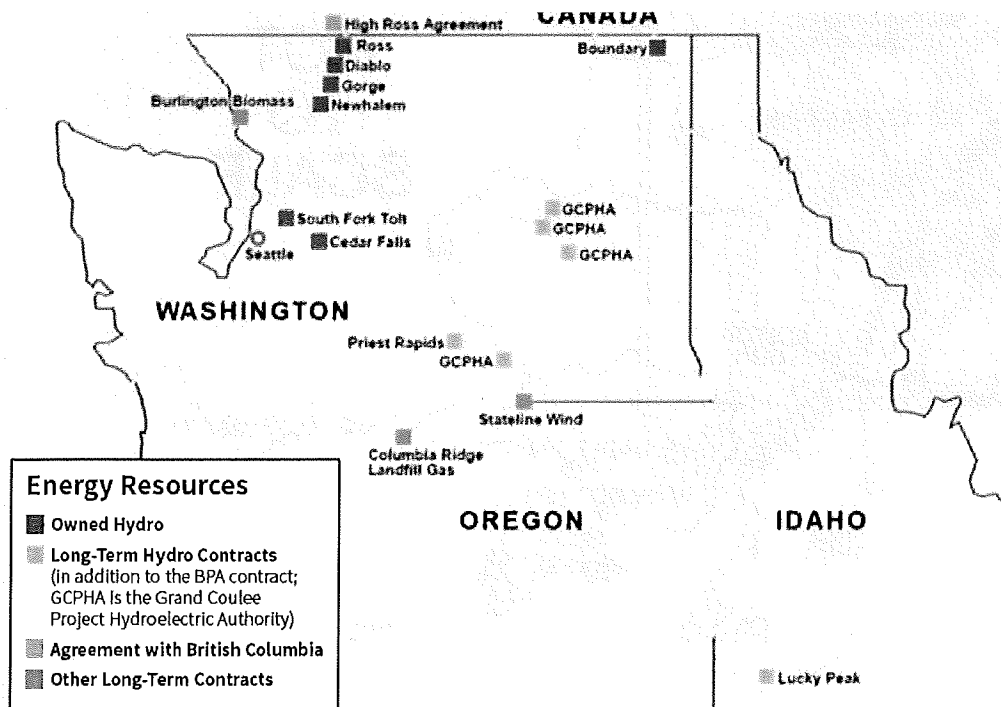

Source: City Light, 2015

Utilities Appendix Figure A-3

Electrical Transmission and Substation System

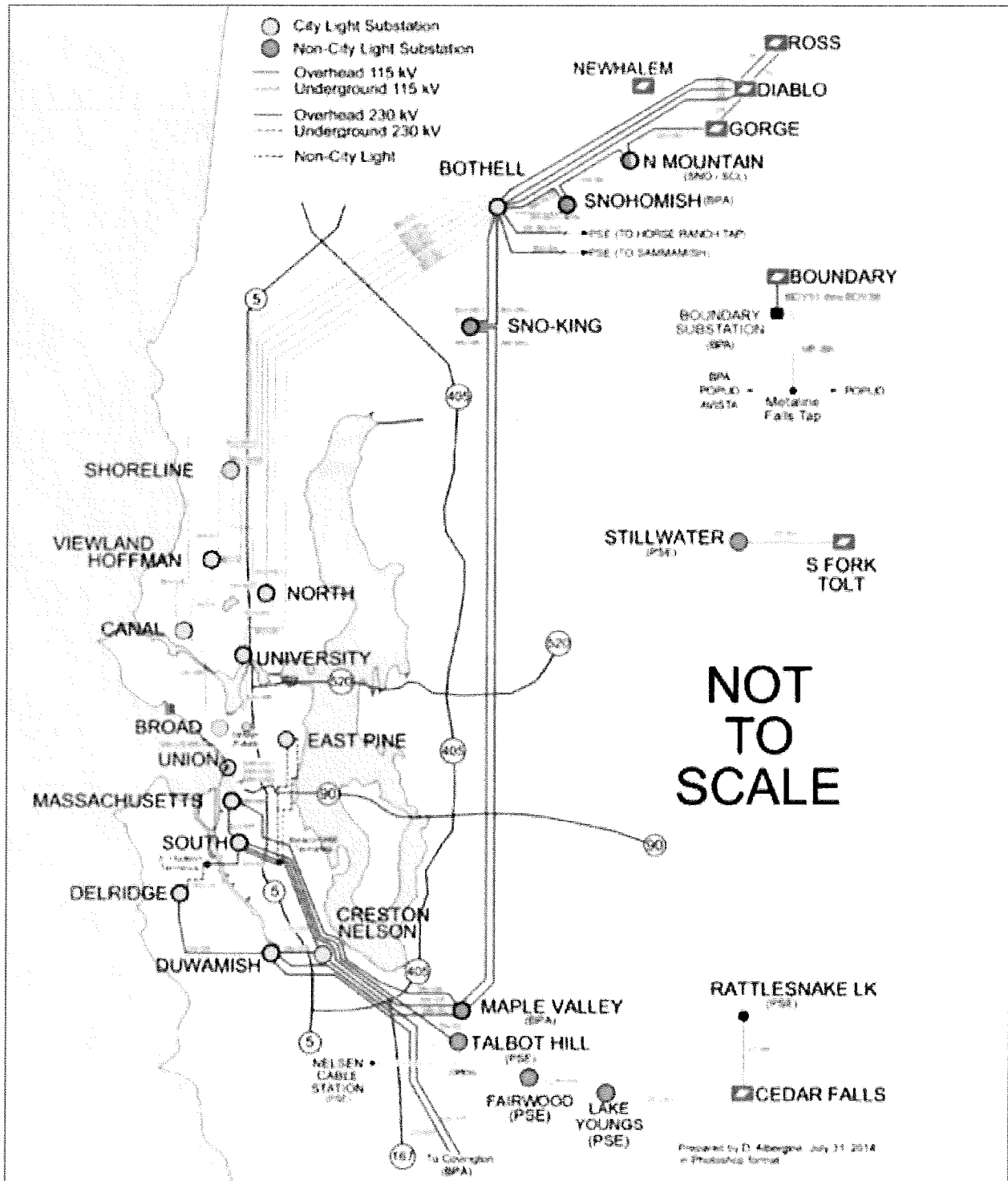

Source: City Light, 2014

SCL's current generation capability (owned and contracted) is adequate to serve existing customers. Because of the nature of City Light's hydroelectric system, the utility is not presently constrained by its ability to meet peak loads (typically referred to as capacity). At times, the system may be constrained in its ability to carry load over periods of heavy load hours (6 a.m. to 10 p.m.) during the winter. On an average monthly basis, City Light currently has sufficient resources to meet expected customer load in the next few years, even under serious drought conditions.

SCL sells on the wholesale energy markets the energy it does not need to meet customer load. The utility also buys energy in the wholesale markets to enhance the value of its resource portfolio and to meet occasional short-term energy deficits.

Seattle City Light: Future Needs Assessment

New resources will be needed to meet load growth and to comply with I-937 over the next twenty years. The timing of resource acquisition depends on the rate of load growth, hydro volatility, together with the I-937 schedule for acquiring renewable resources and/or renewable energy credits.

For the transmission and distribution components of SCL's system, projected growth will be accommodated by planned transmission and distribution capacity additions. The pending addition of a Downtown substation will meet the load growth in Denny Triangle and South Lake Union.

Capacity would also be expanded at the North, Duwamish, Shoreline, University, and Creston substations. New substations also may be built in the next five to twenty years in Interbay, SODO, and the Highline area, depending on load growth projections and emerging real construction. Substations in the northeast and northwest parts of the City may also be built in the twenty-year period. City Light owns properties for the Interbay, Northeast, and Northwest substations.

Seattle Public Utilities: Drinking Water

Seattle Public Utilities (SPU) provides drinking water to a service area population of 1.3 million within the greater Seattle metropolitan region of King County and portions of southern Snohomish County. SPU provides retail water service to customers in the City of Seattle, and portions of the cities of Shoreline, Lake Forest Park, and Burien, as well as portions of unincorporated King County south of the City of Seattle. SPU also provides retail water service to Shorewood Apartments on Mercer Island and Seattle Tacoma International Airport. In addition, SPU sells wholesale water to nineteen municipalities and special-purpose districts, plus Cascade Water Alliance, who in turn provide the water to their own retail customers (*see Utilities Appendix Figure A-4*). SPU operates under an annual operating permit issued by



the Washington State Department of Health. More information about the water system can be found in Seattle's latest Water System Plan.

Seattle Public Utilities: Inventory & Capacity

SPU supplies drinking water from two major water supply sources, the Cedar River Watershed and the South Fork of the Tolt River Watershed, both on the western slopes of the Cascade Mountains. In addition, a small amount of water from Seattle Well Fields, which are located north of Seattle Tacoma International Airport, is available to provide drought and emergency supply. In total, these sources can supply up to 172 million gallons of water per day on an average annual basis. Water from these sources is treated to meet drinking water quality regulations. The treated water is then delivered to Seattle retail and wholesale customers through a network of approximately 1,880 miles of transmission and distribution system pipelines, 400 million gallons of treated water storage facilities (reservoirs, tanks, and standpipes), and thirty-one pump stations. System-wide treatment and transmission capacity is 310 million gallons per day (*see Utilities Appendix Figure A-4*).

Utilities Appendix Figure A-4

Drinking Water Service Area

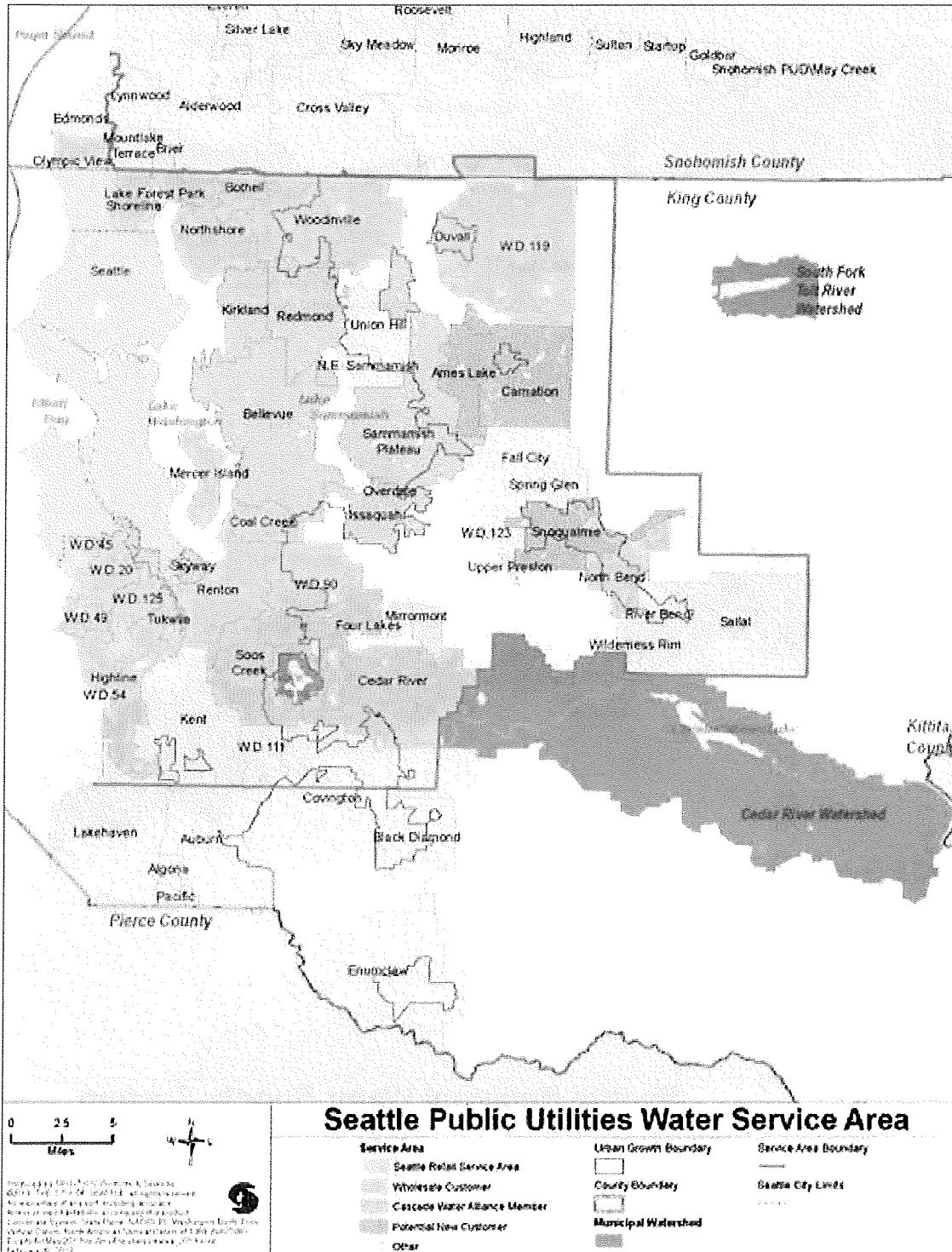

Source: Seattle Public Utilities

Utilities Appendix Figure A-5

Drinking Water Facilities and Transmission Pipelines

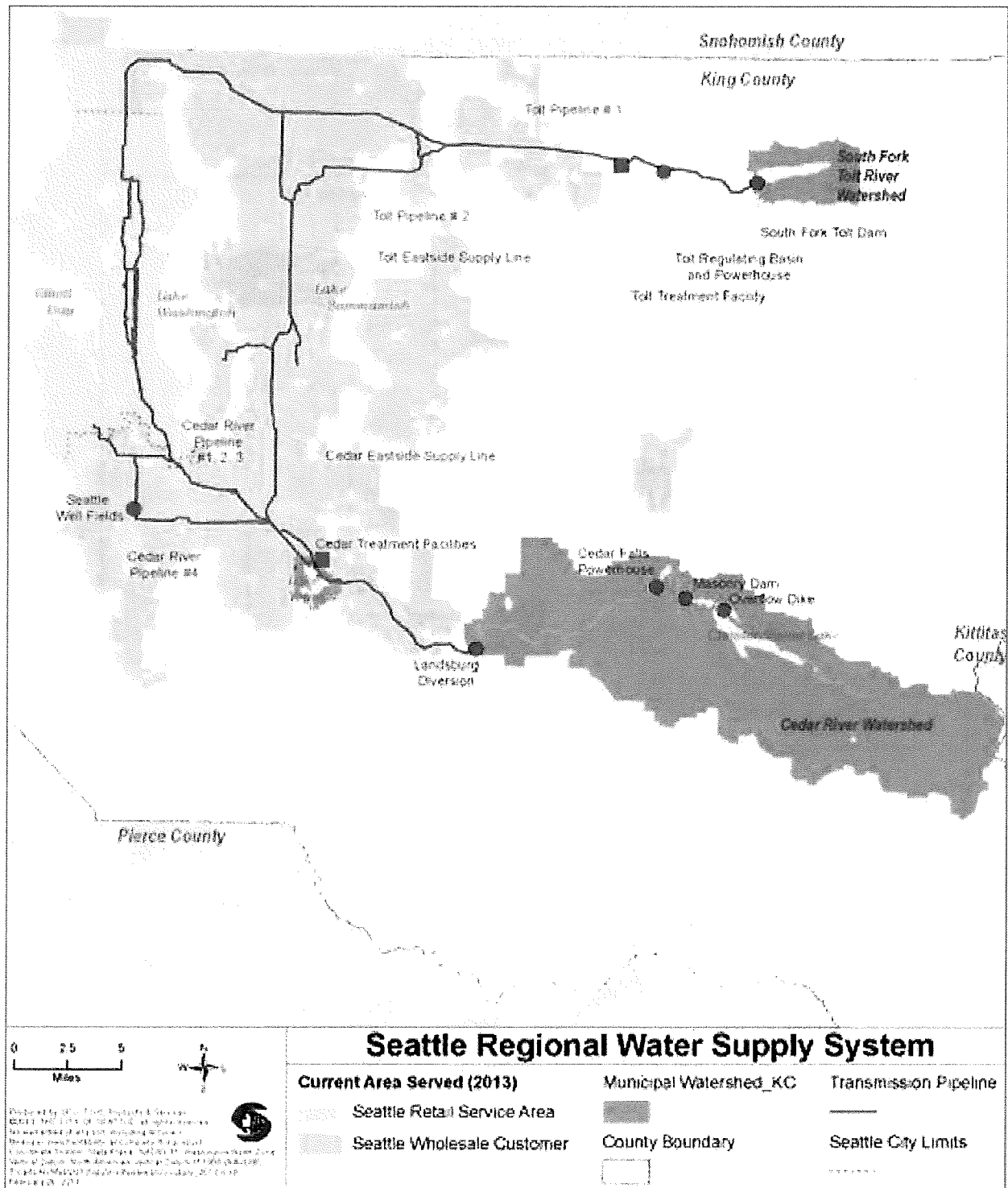

Source: Seattle Public Utilities

Seattle Public Utilities: Future Needs Assessment

SPU expects water supply to be adequate to serve the City's existing and forecast population for at least the next twenty years. This assessment considered an analysis of future climate change impacts on both supply and demand. That analysis indicated that, although available supply could be reduced by as much as 4 percent in 2025 and 6 percent in 2050 under the warmest climate change scenario analyzed, this reduced supply would still exceed climate-impacted demands in those time periods.

One reason for this outlook is the anticipated continued reduction in per capita water use in SPU's service area. Total water use in SPU's regional water system declined by 15 percent from 2000 to 2013 while the population served has grown by 30 percent. The regional water conservation program administered by SPU for the Saving Water Partnership—a collaborative program run by Seattle and eighteen of SPU's wholesale customers—has been a contributor to this reduction in water use. For the 2013–2018 period, the Saving Water Partnership has set a goal to reduce per capita water use from current levels so that total average annual retail water use of members of the Saving Water Partnership is less than 105 million gallons per day despite forecasted population growth.

Distribution and storage facilities that serve Seattle residents and businesses have adequate capacity to serve the city. There are, however, a few areas where SPU's water system has hydrants that cannot provide fire flows to existing buildings as required under current codes for new buildings. This can be caused by a combination of factors including pipes with small diameters or areas with low water pressure due to older design standards, or pipes whose interiors have been reduced by deposits. There are also areas that were originally built to now-obsolete fire codes. Depending on the location and type of development, parts of SPU's water distribution system may need to be upgraded to meet current fire flow standards for the planned development. Additionally, there are also parts of the retail service area in which water mains need to be extended to serve a particular parcel. SPU will work with developers to have needed water infrastructure in place for the development.

In addition to the distribution system improvements needed to support new development, investments are needed to replace aging infrastructure that has reached the end of its economic life. SPU is currently applying an asset management assessment to determine which facilities would be replaced using the funds available in the six-year CIP instead of being repaired.

Seattle Public Utilities: Drainage & Sewer

Seattle Public Utilities is charged with managing drainage and sewer systems to meet public safety, water quality, and resource protection goals. SPU's drainage and sewer service area covers the City of Seattle. King County is responsible for operating the sewage treatment

plants that treat all City of Seattle sewage as well as the interceptor lines that deliver sewage to these facilities.

Seattle Public Utilities: Inventory & Capacity

Although a few small areas are still served by septic systems, almost all areas of the city are served by sewer. Three types of drainage and sewer systems are used in Seattle:

- *combined drainage and sewer (a single set of pipes carries water from drainage water and sewage)*
- *separate drainage sewer systems (the pipes carrying drainage are completely separate from the pipes carrying sewage), and*
- *partially separated drainage and sewer (one set of pipes carries sewage and some drainage water—generally from street runoff—while the other set carries only drainage water).*

The SPU system collects residential, commercial, and industrial sewage and delivers it to interceptor lines operated by the regional sewage treatment agency (King County). While King County operates a regional system including various treatment plants, sewage from Seattle is primarily treated at the West Point Sewage Treatment Plant before being discharged into Puget Sound (*see Utilities Appendix Figure A-5*). The West Point Treatment Plant is a secondary treatment facility, with a monthly average capacity of 133 million gallons per day (MGD) and daily peak flow capacity of 440 MGD. Of the daily peak flow capacity, 300 MGD would receive secondary treatment and the remainder would receive primary treatment. The West Point Treatment Plant serves 1.3 million people including residents of Seattle, King County north of Seattle, and South Snohomish County.

The capacity of the drainage and sewer system in some areas is limited during peak storm events. During or following intense or prolonged periods of rainfall, some of the systems cannot accommodate the combined drainage and sewage flows, resulting in combined sewer overflows (CSOs) being discharged into area waters. CSOs occur in both the regional and the City systems. There are two “wet weather” treatment facilities, Alki and Carkeek, that partially treat a portion of this overflow, but in many areas the overflows discharge completely untreated water.

The City of Seattle has prepared a comprehensive strategy, called The Plan to Protect Seattle’s Waterways, to reduce overflows and discharge of pollutants from combined sewers and the storm drain system. This plan identifies areas of Seattle where projects are needed to reduce CSOs, evaluates alternatives for reducing CSOs in these areas, and recommends a schedule for designing and constructing projects.

Seattle Public Utilities: Future Needs Assessment

Generally, the City-operated drainage and sewer facilities in Seattle have been planned and sized to serve the maximum or build-out conditions under zoning at the time and will be adequate to serve the level of increased growth proposed in the plan. The capacity of the sewer system is limited in confined areas of the city, where there have been historic hydraulic and system backup problems. In addition, there are areas of drainage deficiencies and water quality issues in the city. These problems are being addressed through developer-funded facility upgrades and by Seattle Public Utilities' Capital Improvement Program (CIP).

Seattle Public Utilities: Solid Waste

Various state and local regulations and guidelines influence Seattle's solid waste planning. Chief among the regulations is the State of Washington's 1969 legislation Revised Code of Washington (RCW) 70.95 requiring local solid waste plans. Seattle Public Utilities manages this responsibility by regularly reviewing and updating Seattle's Solid Waste Plan. The Plan has a twenty-year horizon and provides strategies for future solid waste management needs.

Seattle Public Utilities: Inventory & Capacity

A network of public and private service providers and facilities collect, transfer, process, and landfill Seattle's discards. All Seattle's municipal solid waste that is not recycled or composted is, by law, under city control.

SPU contracts with private firms to collect residential garbage, recyclables, and yard and food waste (organics). The same contractors collect commercial garbage. Open-market providers collect commercial recycling and organics. Businesses may choose to "self-haul" their solid waste materials.

Transfer and recycling processing facilities consolidate collected solid waste materials and route them to their next destination. Garbage and organics collected by the city's contractors go to the transfer stations owned and operated by the city. Recycling picked up by the city's contractors goes to the city's contracted recycling processing facility. Recycling picked up from businesses may go to a recycling processor or one of the many local businesses specializing in recycled materials. Other collected materials go to the city's transfer stations, or private transfer stations or processors. Occasionally, residential garbage is taken to private transfer facilities, such as when a city station temporarily needs to close.

At the transfer stations, garbage is loaded into rail containers and trucked to Seattle's contracted rail yard. Assembled trains of containers are hauled to the city's contracted landfill.

Processed recyclables go to various materials markets. Organics go to the City's contracted organics contractor to be processed into compost.

SPU also runs two moderate-risk waste (MRW) collection facilities. Seattle provides this service as a partner in the Local Hazardous Waste Management Program (LHWMP) in King County.

Except for the two City-owned transfer stations, the equipment and facilities necessary to operate Seattle's solid waste system are provided by contracted services.

Seattle Public Utilities: Collection

Two collection companies collect all residential solid waste materials and commercial garbage. Current contracts started in March 2009 and run until at least 2017. The companies provide all aspects of collection, including trucks, truck yards, and labor. Service areas and routes are planned to ensure efficient use of collection vehicles and to collect consistent amounts of material each day so that the daily capacity of each transfer station is not exceeded. Transfer and processing facilities need an even, predictable inflow to avoid having to stockpile incoming materials.

Seattle Public Utilities: Transfer Stations

The city owns and operates two transfer stations: North Transfer Station in the Wallingford neighborhood, and South Transfer Station in the South Park neighborhood. Two private transfer stations supplement city facilities.

The city's transfer facilities now serve a variety of vehicles and customers and receive a range of discarded materials that include garbage, recyclables, and compostables. In addition to transferring materials delivered by collectors, the stations play an important role in accepting materials unsuitable for curbside collection. Residents with large, bulky items or excess quantities can bring these materials to the stations for recycling or disposal. The stations also serve businesses that choose to self-haul their waste and recyclable materials.

In 2007, the Seattle City Council decided to proceed with improvements to the two city-owned stations, which were originally built in the 1960s. SPU completed construction of the new South Transfer Station in 2013. The new North Transfer Station will be complete in 2016. Demolition of the old South Recycling and Disposal Station and redevelopment of that site is scheduled to be complete in 2018.

The two private transfer facilities are located in the industrial area south of Downtown Seattle.

Seattle Public Utilities: Recycling and Composting

SPU contracts with Rabanco Recycling Center for traditional recycling (newspaper, glass bottles, tin cans, etc.). It is located in the Duwamish Manufacturing/Industrial Center.

Most commercial recycling is provided by private arrangements. Vendors collect both mixed and source-separated materials, and take them to a variety of processors in the Seattle area. Which processor they use depends on the material and any agreements haulers and processors may have.

For organics composting, SPU implemented new contracts in 2014 with two vendors: Lenz Enterprises, Inc., and PacifiClean Environmental of Washington, LLC. Lenz Enterprises is mainly responsible for taking organics from SPU's Seattle's North Transfer Station to its processing facility in Stanwood, Washington. PacifiClean takes mainly organics from SPU's South Transfer station to their processing facility that will be located in central Washington. Both companies have guaranteed access to backup facilities.

Seattle Public Utilities: Disposal

The City of Seattle contracts with Waste Management of Washington for rail haul and disposal of all nonrecyclable waste at Columbia Ridge Landfill in Gilliam County, Oregon. After it has been compacted into shipping containers at transfer facilities, garbage is hauled to the Argo rail yard and loaded onto the train. The Argo Yard is owned and operated by the Union Pacific Railroad, and is located in the Duwamish Manufacturing/Industrial Center. Trains leave Seattle six times a week, stacked two-high. Waste Management of Washington owns the containers. The Columbia Ridge Landfill and Recycling Center is owned and operated by Oregon Waste Systems, a division of Waste Management.

Seattle Public Utilities: Future Needs Assessment

As the City of Seattle contracts with private service providers for recycling processing, organics composting, and landfill long-haul and disposal, any programmatic changes would be made through those contracts. Since Public Health—Seattle & King County regulates all solid waste handling facilities in their jurisdiction, their approval is required for any new public or private facilities for the transfer, recycling, composting, and landfilling of solid waste materials.

Although the overall amount of waste generated in the city will increase with projected residential and employment growth over the twenty-year plan horizon, the percentage of waste that will be directed to disposal is expected to decrease. Seattle's overall municipal solid waste generation (MSW) has generally followed the ups and downs of economic trends, even as population has steadily increased. Total generation saw a prolonged downward

trend after 2007 through the Great Recession and through 2012. SPU expects overall waste generation to increase gradually over the next two decades, not rising to pre-recession levels of about 850,000 tons of material per year until about 2027 or after.

Seattle's diversion goal is to recycle or compost 70 percent of the city's MSW by 2022. In 2012 Seattle recycled or composted 56 percent of its MSW. Seattle recently set an additional goal to recycle 70 percent of the city's construction and demolition (C&D) waste by 2020. The majority of C&D waste is managed in the private sector, from generation through processing and disposal.

Shifts in consumer patterns change over time. Likewise, new materials and combinations of materials continue to enter the consumption cycle. SPU will conduct waste composition analyses frequently enough to be able to respond to these changes. For example, SPU will continue to work with processors to designate additional recyclable materials, and modify collection programs as needed.

Future Needs Assessment

Collection

Seattle will continue with its strategy to competitively contract for collection services. The contractors will adjust to changing service needs, such as more recycling, over time.

Transfer

The capacity provided by the rebuild of Seattle's two transfer facilities, in conjunction with private transfer capacity, is projected to satisfy Seattle's solid waste transfer needs for at least as long as the fifty-year expected life of the rebuilt facilities. Seattle's new facilities are purposely designed for flexibility in response to a changing mix of solid waste materials over time.

Recycling & Composting

Recycling capacity at private facilities is considered adequate for at least two decades, and Seattle will continue to contract for these services. Seattle's current contract is guaranteed through 2019. In 2014, Recology Cleanscapes opened a new high-capacity mixed-material recycling facility in the Duwamish Manufacturing/Industrial Center. Furthermore, the Washington State Department of Ecology currently lists more than 280 recycling facilities in King, Pierce, and Snohomish Counties. In addition to the new Recology Cleanscapes facility, at least three of these are large facilities that process mixed recycling and are within twenty

miles of Seattle. SPU expects that many other private recyclers that handle limited ranges of materials will continue their presence in the local market.

Current composting capacity is adequate for the twenty-year planning horizon. However, statewide there is concern about future capacity as more cities and counties divert more organics. Seattle's two organics contracts are guaranteed, and may be extended through 2024. As regional demand for composting increases, composting service providers are researching and developing new technologies, for example anaerobic digestion.

Disposal

Columbia Ridge landfill, Seattle's current contracted landfill, projects that it will be able to receive material beyond the current contract's guaranteed 2028 end date. Seattle plans to continue with contracting for this service. Although Seattle's disposal alternatives are restricted through the life of the contract, the City will continue monitoring emerging alternate technologies. Rail-haul capacity has not been an issue. The contract provides for alternate transportation if rail lines become unavailable.

City Communications Facilities

The City Department of Information Technology, in collaboration with City Light and other departments, jurisdictions, and institutions, installs, owns, and/or operates an extensive radio and broadband information and communications technology (ICT) infrastructure, including radio for emergency services and fieldwork, and fiber optic for transmission of voice, video, and data for delivery of city services. The City leases some services from private providers, but has steadily increased the network of public infrastructure to city buildings. The City has a fiber-sharing agreement with other public agencies that enables joint installation and maintenance of an extensive network of conduit and which minimizes cost, digging, and installation of broadband infrastructure. The City also leases excess fiber capacity to private providers.

Investor-Owned Utilities

Natural Gas

Puget Sound Energy (PSE) provides natural gas service to more than 780,000 customers in six Western Washington counties: Snohomish, King, Kittitas, Pierce, Thurston, and Lewis. As of 2014, it is estimated that PSE serves over 140,000 customers within the City of Seattle.

Natural gas comes from gas wells in the Rocky Mountains and in Canada and is transported through interstate pipelines by Williams Northwest Pipeline to Puget Sound Energy's gate stations.

Supply mains then transport the gas from the gate stations to district regulators where the pressure is reduced to less than 60psig. Distribution mains are fed from the district regulators, and individual residential service lines are fed by the distribution mains.

PSE does not have any major projects planned in Seattle, but new projects may be developed in the future at any time due to:

- *New or replacement of existing facilities to increase capacity requirements due to new building construction and conversion from other fuels.*
- *Main replacement to facilitate improved maintenance of facilities.*
- *Replacement or relocation of facilities due to municipal and state projects.*

Cable

The FCC provides limited regulatory authority to local jurisdictions to enable franchise agreements with providers of cable television. As of 2014, the City of Seattle had cable franchise agreements with two companies: Comcast and Wave Broadband. Comcast is the city's largest provider, serving approximately two-thirds of the city. These companies also provide telephone and broadband Internet services. As of 2014, Wave also owns CondoInternet, which offers gigabit Internet service in a limited, but growing area of Seattle.

The franchise agreements provide for consumer protection and public benefits, such as delivery of cable television and public Internet access to City community centers, public housing, and nonprofits providing Internet access and skills training to technology-disadvantaged residents. The companies are allowed to compete, though overlapping service areas have been minimal as of 2014. The franchise agreements have generally been for ten-year periods with some adjustment when companies are sold. See seattle.gov/cable/franchises.htm for more detail.

Landline Telephone

CenturyLink, which purchased QWEST Communications, is the largest telephone company providing local landline telephone and related retail and wholesale communications services throughout the entire city. They maintain a number of poles, transmission lines, and network architecture. Additionally, there are a number of small companies that provide limited telephone service, often by paying for the use of another company's infrastructure.

Wireless and Cellular

Seattle is served by numerous companies providing wireless and cellular services. These communications utility companies tend to own wireless and cellular transmission facilities as well as fiber backbone to relay the data received in the transmission facilities. Common wireless technologies include point-to-point microwave as well as Wi-Fi internet services. Microwave antennas require location for line-of-sight transmission. Cellular and Wi-Fi transmitters have limited transmission radius and are also dependent on the strength of the antenna in users' mobile devices. As the number of users and the demand for higher data transfer (e.g., for watching or sending video) grows, the infrastructure will also require expansion. Greater distribution of fiber optics through the city enables higher bandwidth connections to these antennas. The industry is continuing to evolve, so the city is likely to see continued demand for placement of antennas, though technology developments may also result in some reduction of the number required.

Radio and Broadcast Television

Seattle is also served by a number of radio and television broadcast facilities who maintain antennas and transmission equipment in the city, which, like cellular equipment, may be located and operated on company sites, or placed on other public or private buildings through leasing arrangements. Some of these companies also operate other communications hosting or networking services. The FCC issued a limited number of low-power FM construction licenses to nonprofit entities, starting in 2014, that require siting of small antennas and will enable local information distribution.

District Energy

Enwave Seattle is a district energy utility franchised by the City. Enwave produces heat at a centralized plant and distributes steam to commercial, residential, and institutional customers for space and water heating, along with other uses, by underground lines. Its service area encompasses roughly a square-mile area of the Central Business District, extending from Blanchard Street to King Street and from the waterfront to 14th Avenue, crossing over First Hill.

Enwave Seattle is a privately owned utility that provides heat to approximately 200 buildings in Seattle's Central Business District and First Hill neighborhoods. Enwave Seattle's mission is to deliver a reliable, cost-effective, and efficient source of heat that benefits its customers, the environment, and the Seattle community.

Two steam-generating plants supply the piping network. The primary plant is located on Western Avenue at University Street. The secondary plant is located on Western Avenue near Yesler Way—the site of the original plant built in 1893. Total steam generation capacity

is 670,000 pounds per hour, with boilers designed to burn renewable biomass, natural gas, or diesel oil if natural gas is not available. The network of insulated steel pipe encompasses a total length of over eighteen miles beneath city streets and currently serves approximately 200 buildings.

The City is also working to establish district energy utility systems in South Lake Union, Denny Triangle, and First Hill. Systems for these neighborhoods are in varying planning stages, but each, if established, would likely be a closed-loop water-based utility system providing heating, hot water, and potentially cooling services to building owners. Energy sources for the utility system would largely comprise waste heat already in the neighborhood, including waste heat from data centers, sewer lines, and condensate from the nearby Enwave system.

Legislative History of the Comprehensive Plan

The Comprehensive Plan was first adopted on July 25, 1994, by Ordinance 117221.

Comprehensive Plan Amendments

Adoption Date	Ordinance Number	Nature of Amendments
12/12/94	117436	1994 Capital Improvement Program
7/31/95	117735	1995 Comprehensive Plan amendments
11/27/95	117906	Adoption of a new Human Development element
11/27/95	117915	1995 Six-Year CIP amendments
7/01/96	118197	Response to 4/2/96 Growth Management Hearings Board remand. Repealed policy L-127 of Ord. 117735
9/23/96	118408	Addition of Shoreline Master Program to Plan
11/18/96	118388	1996 CIP amendments
11/18/96	118389	1996 annual amendments
6/16/97	118622	Policies for the reuse of Sand Point Naval Station
9/8/97	118722	Response to 3/97 GMHB remand
11/13/97	118820	1997 Six-Year CIP amendments
11/13/97	118821	1997 annual amendments; addition of Cultural Resources element
6/22/98	119047	Adoption of the Ballard/Interbay Northend Manufacturing/Industrial Center neighborhood plan

Adoption Date	Ordinance Number	Nature of Amendments
8/17/98	119111	Adoption of the Crown Hill/Ballard neighborhood plan
10/26/98	119207	1998 annual amendments
11/02/98	119217	Adoption of the Wallingford neighborhood plan
11/02/98	119216	Adoption of the Central Area neighborhood plan
11/16/98	119231	Adoption of the Pioneer Square neighborhood plan
11/16/98	119230	Adoption of the University neighborhood plan
11/23/98	119264	1998 Six-Year CIP amendments
12/07/98	119322	Adoption of the Eastlake neighborhood plan
12/14/98	119298	Adoption of the MLK@Holly neighborhood plan
12/14/98	119297	Adoption of the Chinatown/International District neighborhood plan
1/25/99	119356	Adoption of the South Park neighborhood plan
2/08/99	119365	Adoption of the Denny Triangle neighborhood plan
3/15/99	119401	Adoption of the South Lake Union neighborhood plan
3/15/99	119403	Adoption of the Queen Anne neighborhood plan
3/22/99	119413	Adoption of the Pike/Pine neighborhood plan
3/22/99	119412	Adoption of the First Hill neighborhood plan
5/10/99	119464	Adoption of the Belltown neighborhood plan
5/24/99	119475	Adoption of the Commercial Core neighborhood plan
6/07/99	119498	Adoption of the Capitol Hill neighborhood plan
7/06/99	119524	Adoption of the Green Lake neighborhood plan
7/06/99	119525	Adoption of the Roosevelt neighborhood plan
7/09/99	119538	Adoption of the Aurora-Licton neighborhood plan
7/21/99	119506	Adoption of the West Seattle Junction neighborhood plan
8/23/99	119615	Adoption of the Westwood/Highland Park neighborhood plan
8/23/99	119614	Adoption of the Rainier Beach neighborhood plan
9/07/99	119633	Adoption of the North Neighborhoods neighborhood plan
9/07/99	119634	Adoption of the Morgan Junction neighborhood plan
9/27/99	119671	Adoption of the North Rainier neighborhood plan

Adoption Date	Ordinance Number	Nature of Amendments
10/04/99	119685	Adoption of the Broadview/Bitter Lake/Haller Lake neighborhood plan
10/04/99	119687	Adoption of the Fremont neighborhood plan
10/11/99	119694	Adoption of the Columbia City neighborhood plan
10/25/99	119713	Adoption of the North Beacon Hill neighborhood plan
10/25/99	119714	Adoption of the Admiral neighborhood plan
11/15/99	119743	Adoption of the Greenwood/Phinney Ridge neighborhood plan
11/15/99	119744	1999 annual amendments
11/22/99	119760	1999 Six-Year CIP amendments
12/06/99	119789	Adoption of the Delridge neighborhood plan
2/07/00	119852	Adoption of the Georgetown neighborhood plan
6/12/00	119973	Adoption of the Greater Duwamish Manufacturing/Industrial Center neighborhood plan
11/13/00	120158	Response to Growth Management Hearings Board remand; Greenwood/Phinney Ridge neighborhood plan
12/11/00	120201	2000 five-year Comprehensive Plan review amendments
10/15/01	120563	2001 annual amendments
12/09/02	121020	2002 annual amendments
12/13/04	121701	2004 ten-year Update to Comprehensive Plan
10/10/05	121955	2005 annual amendments
12/11/06	122313	2006 annual amendments
12/17/07	122610	2007 annual amendments
10/27/08	122832	2008 annual amendments
3/29/10	123267	2010 annual amendments
4/11/11	123575	2011 annual amendments
4/10/12	123854	2012 annual amendments
5/20/13	124177	2013 annual amendments
5/2/14	124458	2014 annual amendments
10/16/15	124888, 124887	2015 annual amendments

Resolutions Related to Vision for City of Seattle Comprehensive Plan

Passage Date	Resolution	Nature of Legislation
7/25/94	28962	1994 Vision for the Comprehensive Plan
11/27/95	29215	Updated 1994 Vision to reflect addition of Human Development element in Comprehensive Plan (Ord. 117906)
12/11/00	30252	Updated Vision to reflect Cultural Resources and Environment elements and adoption of neighborhood plans
12/13/04	30727	Updated Vision in conjunction with the 2004 ten-year Update to the Comprehensive Plan
5/15/15	31577	Confirmed race and social equity as a core value of the Comprehensive Plan



Seattle City Council Amendments to
Seattle 2035
Comprehensive Plan

Attachments 2 through 17 to Council Bill 118683

Notes:

The edits shown in the following attachments specify the City Council's amendments to the Mayor's Recommended Comprehensive Plan (which is Attachment 1 to Council Bill 118683) Numbers adjacent to each amendment refer to the amendments as approved by the PLUZ Committee at their September 20 meeting.

Specific language to be deleted from the Mayor's Recommended Comprehensive Plan is shown in ~~strikethrough~~.

Specific language proposed to be added to the Mayor's Recommended Comprehensive Plan is shown underlined.

*** indicates that adjacent text has been omitted.

Attachment 2. Amendments to the Title and Introduction

City Council's Amendment

- 1 Amend the title of the plan to reintroduce the word "sustainable" as follows:

Seattle 2035
Comprehensive Plan
Managing Growth to Become an Equitable and Sustainable City
2015-2035

- 2 On page 3, amend the introductory language as follows:

Race and Social Equity. Seattle believes that every resident should have the opportunity to thrive and to be a part of the city's growing economy. In 2015 the mayor and the City Council adopted a resolution that changed the title of this value from "social equity" to "race and social equity," to emphasize the need to address disparities experienced by people of color. In 2016, at Council's request the Office of Planning and Community Development developed the Growth and Equity Analysis. The results of the Growth and Equity Analysis inform elected officials and the public about potential future displacement impacts of the recommended Growth Strategy on marginalized populations; and strategies for mitigating identified impacts and increasing access to opportunity for marginalized populations.

- 3 Amend page 6, and other places throughout the Plan, to change "Disabled people" to "People with disabilities"

- 4 On page 6, amend the Plan as follows:

also aims to give all Seattle residents better access to jobs, education, affordable housing, parks, community centers, and healthy food.

In 2016, the City published a report titled Growth and Equity. That report compiles data about several economic and demographic factors that help identify places in the city where residents, especially people of color and low-income residents, could be at risk of displacement or where there is less access to employment and other opportunities. The City used information from this report to shape this Plan's preferred pattern of growth, as described in the Growth Strategy Element. The City will continue to monitor the conditions contained in the report.

City Council's Amendment

The goals and policies in this Plan can also influence the actions of other government agencies and private businesses to promote social justice and racial equity. Working toward equity will help produce stronger and more resilient economic growth—growth that benefits everyone.

5 On page 7, amend the Plan as follows:

Move the section that begins with:

Environmental Stewardship. Even as the city becomes increasingly urban, Seattle is dedicated to protecting and restoring the green spaces and water that make our city special...

And ends with:

Yet there was one goal in common: to make Seattle the best city for living, working, and raising families. This Plan encourages continued broad public participation in decisions that affect all aspects of the city.

...to page 6, after this text:

The discussions that introduce sections of this Plan highlight other facts about some conditions or services as they relate to the income or racial characteristics of people in Seattle.

6 On page 7, amend the Plan as follows

The City has committed to make Seattle carbon neutral by the year 2050 in order to reduce the threat of climate change. To reach this ambitious and important goal, local government, businesses, and residents will need to work together. Seattle's Climate Action Plan provides long-term planning direction and guidance for climate protection and adaptation efforts through 2030. This Plan contains consistent goals and policies to help guide this effort. For instance, the Growth Strategy and Transportation elements promote development that will make walking, biking, and public transit viable options for more people so that they can be less reliant on automobiles—a major source of carbon emissions in this region.

Seattle charged the 2012 Green Ribbon Commission to help create a climate action plan that increases the circle of economic prosperity, affordable housing, public health, and social equity while protecting our planet for future generations. Seattle's Climate Action Plan provides long-term planning direction and guidance for climate protection and adaptation efforts through 2030.

**

City Council's Amendment

7 On Page 14, amend the Plan as follows

Seattle's population in ~~2015~~ 2016 is estimated to be 662,400 686,800, and growth over the next twenty years will add about 120,000 people to that total.

8 On page 15, amend the Plan as follows

To simplify the monitoring process, the City has identified several indicators that ~~could~~ will provide insights about progress on key issues addressed by the Plan. The City will collect baseline data and track these indicators over time. Indicators will be tracked for the city as a whole and for each urban village as feasible to help assess progress in implementing the Growth Strategy. The City will report regularly on ~~these changes in these~~ indicators to help the public and elected officials judge the effectiveness of the Plan and the City's actions to implement it. ~~Where data is available, the City will report it for each urban village to help assess each one's status.~~ These indicators include:

- the number of new housing units;
- the number of demolished housing units;
- the number of jobs;
- the number of income- and rent-restricted affordable housing units;
- ~~age, race, and household composition;~~
- access to frequent transit service;
- presence of sidewalks;
- the number of households with access to open space;
- City infrastructure investment; and
- housing costs.

In addition to monitoring the items listed above, the City will use other indicators that ~~will show to help gauge~~ how well it is are doing in to making make the city a more equitable place. This set of indicators will help show where in the city marginalized populations are at higher risk of being displaced by development; it will also include measures of housing affordability and other long term equitable development outcomes.

City Council's Amendment

Demographics, including age, race and ethnicity, and household composition will be reported as part of these monitoring efforts, and information on household income levels will be included along with the equitable development indicators.

9 On page 17, amend the Plan as follows

Implementation of most policies involves a range of City actions over time, so one cannot simply ask whether a specific action or project would fulfill a particular Plan policy.

Attachment 3. New Community Involvement Element

Council's Amendment

185 On pages 158-160, delete the Neighborhood Planning Element and add a Community Involvement Element to the plan, as follows:

Community Involvement Element

Introduction

The City is committed to community involvement in decision-making processes that affect community members. City departments use community involvement to create plans, design programs, and guide city investments and policy decisions.

The City benefits from community involvement in many ways:

- Better understanding of community values, needs, priorities and differing perspectives;
- Local knowledge and expertise of community members are valued and shared;
- Improved decision-making leading to better quality plans and projects;
- Informed community members understand tradeoffs in decision-making;
- Enhanced trust and confidence in government;
- Increase understanding about the different roles community input can play in the decision-making process;
- More community support for plans and projects; and
- More cost efficient and timely implementation.

Inclusive and Equitable Community Involvement

Discussion

Equity is essential to any community involvement process to improve relationships and outcomes. The City is committed to conducting inclusive and equitable community involvement that effectively reaches a broad range of community members, particularly those affected by the City's decisions. Community involvement should reflect Seattle's commitment to race and social justice, and use practices that are culturally sensitive, responsive and address barriers to participation of marginalized communities.

GOAL

CI G1 Provide opportunities for inclusive and equitable community involvement.

POLICIES

Council's Amendment

- CI 1.1 Promote racial and social justice, human and civil rights, and mutual respect to reduce intolerance, and reach out and bring people together in ways that build bridges between individuals and between groups.
- CI 1.2 Create systems that are reflective of and accessible to communities throughout the city to equitably involve community members in City decision-making.
- CI 1.3 Develop well-designed, responsive, culturally-relevant community involvement plans.
- CI 1.4 Build community capacity for meaningful and authentic community involvement, enhance the ability of community members, including those of marginalized communities, to develop the knowledge and skills to effectively participate in planning and decision-making processes.
- CI 1.5 Provide a wide range of opportunities for obtaining information and involvement in decision-making processes.
- CI 1.6 Seek greater equity and more meaningful involvement by diverse community members (homeowners, renters, businesses, employees, property owners, institutions, youth, seniors, etc.), and especially members of marginalized communities in decision-making processes.
- CI 1.7 Effectively and efficiently manage the use of City and community resources to plan and implement community involvement.
- CI 1.8 Partner with other governments, schools, institutions, and community-based organizations to plan and implement community involvement.
- CI 1.9 Seek to reflect of the diversity of the city in the membership of city-appointed boards and commissions.

Community and Neighborhood Planning

Discussion

Community planning is a specific type of community involvement process that produces plans for particular geographic areas. The City's approach to community planning has evolved over time to become more inclusive. The top-down approaches of earlier decades gave way to a "bottom-up" neighborhood planning process for unique areas, including "urban villages" and "urban centers" designated in the 1994 Comprehensive Plan. Between 1995 and 2000 the City funded neighborhood groups to draft goals, policies and actions that would encourage the pattern and distribution of growth outlined in the Comprehensive Plan. By 2000 City Council adopted policies and goals for 33 neighborhood plans (plus five urban center village plans within the Downtown urban center) into the City's Comprehensive Plan. In recent years, city staff has initiated planning processes in partnership with many neighborhoods to update neighborhood plans, develop implementation plans, and address other planning and development issues. Currently, the

Council's Amendment

Neighborhood Plans section of the Comprehensive Plan contains the goals and policies that have emerged from different community planning initiatives, these goals and policies are the city's adopted "Neighborhood Plans."



Caption: Land Use and Community Planning Over Time

Community planning continues to evolve as the needs of communities, the city, and the region change over time. For example, race and social justice has become an important part of planning. Moving forward, community planning will be an integrated and equitable approach to identify and implement a community's vision for how their neighborhood will grow. Plans will reflect the history, character, and vision of the community but also remain consistent with the overall citywide vision and strategy of the Comprehensive Plan. Creating and implementing community plans can help residents apply this Comprehensive Plan at a local level and can provide more specific guidance than the citywide policies do for areas where growth and change are occurring or desired. In some cases, these plans address topics not covered elsewhere in the plan. In other cases, community plans give local examples for how a citywide policy would best be implemented in that neighborhood. The City will undertake community planning to review and update current neighborhood plans, as well as to address ongoing and emerging issues.

GOAL

CI G2 Work with a broad range of community members to plan for future homes, jobs, recreation, transportation options and gathering places in their community.

POLICIES

- CI 2.1 Use an inclusive community involvement process in all community planning efforts.
- CI 2.2 Undertake community planning that will guide development and public investments within geographic areas.
- CI 2.3 Consider areas with the following characteristics when allocating City resources for community planning.
 - Areas designated urban centers or villages in the Comprehensive Plan

Council's Amendment

- Areas with high risk of displacement
- Areas with low access to opportunity and distressed communities
- Areas experiencing significant improvements in transit service
- Areas experiencing a growth rate significantly higher or lower than anticipated in the Comprehensive Plan
- Areas identified for multiple capital investments that could benefit from coordinated planning
- Areas experiencing environmental justice concerns including public health or safety concerns
- Areas with outdated community or neighborhood plans that no longer reflect current conditions, a citywide vision of the Comprehensive Plan, or local priorities

CI 2.4 Encourage transparency in the development and updating of community plans by:

- Establishing a project committee that reflects community diversity;
- Creating, with community involvement, a detailed project description with the purpose of defining the plan, tasks, timeline and anticipated products;
- Creating, with the project committee, a community involvement plan outlining the tools and methods to be used, and how results will be communicated;
- Monitoring implementation of plans over time; and
- Providing sufficient funding for each step.

CI 2.5 Determine, in collaboration with the community, whether existing community plans meet community needs and priorities and, if not, develop plans to address needs and priorities, some or all of which may be related to the following topics :

- Land use and zoning
- Urban design and community character
- Parks and open space
- Housing, amenities and services to support a range of incomes and household types
- Transportation, utilities and infrastructure
- Economic development
- Community services, institutions and facilities
- Health

Council's Amendment

- Arts and culture
- Climate resilience and adaptation
- Emergency preparedness
- Community organizational capacity
- Equitable development and risk of displacement

CI 2.6 Use an integrated, interdepartmental planning approach to implement community plan recommendations such as capital improvement projects, affordable housing, services, zoning and other City investments.

CI 2.7 Collaborate with the community to implement community plans.

CI 2.8 Assess and report on the implementation of community plans periodically.

CI 2.9 Consult with the community to assess and refine implementation priorities as circumstances change.

CI 2.10 Use outcomes of the community planning process to update the goals and policies in the Neighborhood Plans section of the Comprehensive Plan.

CI 2.11 Maintain consistency between neighborhood plans and the Comprehensive Plan. In the event of a possible inconsistency between the Comprehensive Plan and a neighborhood plan, amend the Comprehensive Plan or the neighborhood plan to maintain consistency.

CI 2.12 Provide sufficient funding and resources to work with communities to update community and neighborhood plans to maintain their relevancy and consistency with community goals and the citywide policies of the Comprehensive Plan.

Attachment 4. Growth Strategy Element Amendments

Council's Amendment	
185 (part)	<p>On pages 21 through 23, delete the Community Engagement section of the Growth Strategy Element (Goal GS1 and Policies GS 1.1 through GS 1.10, pages 21-23)</p> <p>Renumber goals GS 2 through GS5 as GS 1 through GS 4 and policies GS 2.1 through GS 5.4 as policies GS 1.1 through GS 4.4, accordingly.</p> <p>(Note: when a Growth Strategy goal or policy is listed below, the number listed is the number as it appears or would have appeared in the Mayor's Recommended Plan. Those goals and policies should be renumbered accordingly.)</p>
10	<p>On page 23, amend the Plan as follows</p> <p>***</p> <p>Urban Village Strategy</p> <p>Discussion</p> <p>The urban village strategy <u>is Seattle's growth strategy</u> is this Plan's approach to managing growth. This strategy concentrates most of the city's expected future growth in urban centers and urban villages.</p> <p>***</p>
15	<p>On page 25, amend Policy GS 2.4 as follows</p> <p>***</p> <p>GS 2.4 Coordinate planning for transportation, utilities, <u>parks and recreation</u>, open space, libraries, and other public services to meet the anticipated growth and increased density in urban centers and villages.</p> <p>***</p>
16	<p>On page 25, amend Policy GS 2.8 as follows</p> <p>***</p> <p>GS 2.8 Use zoning and other planning tools to shape the amount and pace of growth in ways that will limit displacement of marginalized populations, <u>and that will accommodate and preserve</u> community services, and culturally relevant institutions and businesses.</p> <p>***</p>
17	<p>On page 26, amend Growth Strategy Figure 1, entitled "Urban Center and Urban Village Guidelines" change the second "Characteristic" from "Public Transit Access" to "Access"</p>

Council's Amendment	
18	<p>On page 32, add new policy GS 3.6 to the "Distribution of Growth" section, as follows</p> <p>***</p> <p><u>GS 3.6 Work with communities where growth is slower than anticipated to identify barriers to growth and strategies to overcome those barriers.</u></p> <p>***</p>
153	<p>On page 22, amend the text in the box, as follows</p> <p>***</p> <p>For example, <u>the historically African-American and Asian-American communities at 23rd and Union/Jackson, North Beacon Hill, and Columbia City saw substantial decreases in their populations of color.</u></p> <p>***</p>
154	<p>On page 27, amend Policy GS 2.12, as follows</p> <p>***</p> <p>GS 2.12 Include the area that is generally within a ten-minute walk of light rail stations or very good bus service in urban village boundaries, <u>except in manufacturing/industrial centers.</u></p> <p>***</p>
155	<p>On page 27, add Policies GS 2.18 through GS 2.21, as follows</p> <p>***</p> <p><u>GS 2.18 Promote the use of industrial land for industrial purposes.</u></p> <p><u>GS 2.19 Encourage economic activity and development in Seattle's industrial areas by supporting the retention and expansion of existing industrial businesses and by providing opportunities for the creation of new businesses consistent with the character of industrial areas.</u></p> <p><u>GS 2.20 Strive to retain and expand existing manufacturing and industrial activity.</u></p> <p><u>GS 2.21 Maintain land that is uniquely accessible to water, rail, and regional highways for continued industrial use.</u></p>
156	<p>On page 29, amend the Plan as follows</p> <p>***</p> <p>This Plan anticipates that over the next twenty years, Seattle will add 70,000 housing units and 115,000 jobs. These estimates represent the city's share of King County's</p>

Council's Amendment

projected twenty-year growth. Seattle's comprehensive planning to accommodate this expected growth works from the assumption that the estimates for growth citywide, in urban villages and in urban centers are the minimum we should plan for. The city will monitor various aspects of growth over time and respond with adjusted approaches if growth significantly exceeds the estimates.

158 On page 33, add a new Policy GS 4.8 to the Natural Environment policies, as follows

GS 4.8 Encourage the preservation and expansion of the tree canopy throughout the city for the aesthetic, health and environmental benefits trees provide, considering first the residential and mixed-use areas with the least tree canopy in order to more equitably distribute the benefits to residents.

Renumber policies GS 4.8 through GS 4.26 as policies GS 4.9 through GS 4.27, accordingly.

157 On page 30, amend Growth Strategy Figure 3, as follows

and

Growth Strategy Figure 3

187

Estimated Urban Village Growth Rates

	Expected Housing Growth Rate*	Expected Job Growth Rate*
Hub Urban Villages	40%	50%
With very good transit service**	60%	50%
<ul style="list-style-type: none"> • <u>Ballard</u> • <u>West Seattle Junction</u> 		
With high displacement risk and low access to opportunity, regardless of the level of transit service	40%	50%
<ul style="list-style-type: none"> • <u>Bitter Lake Village</u> • <u>Mt. Baker (North Rainier)</u> 		
<u>Other hub urban villages</u>	<u>40%</u>	<u>50%</u>
<ul style="list-style-type: none"> • <u>Fremont</u> 		

Council's Amendment		
<ul style="list-style-type: none"> • <u>Lake City</u> 		
Residential Urban Villages	30%	N/A
With very good transit service**	50%	N/A
<ul style="list-style-type: none"> • <u>Crown Hill</u> • <u>Roosevelt</u> 		
<u>With high displacement risk and low access to opportunity, regardless of the level of transit service</u>	<u>30%</u>	<u>N/A</u>
<ul style="list-style-type: none"> • <u>23rd & Union-Jackson</u> • <u>Columbia City</u> • <u>North Beacon Hill</u> • <u>Othello</u> • <u>Rainier Beach</u> • <u>South Park</u> • <u>Westwood-Highland Park</u> 		
<u>Other residential urban villages</u>	<u>30%</u>	<u>N/A</u>
<ul style="list-style-type: none"> • <u>Admiral</u> • <u>Aurora-Liction Springs</u> • <u>Eastlake</u> • <u>Green Lake</u> • <u>Greenwood-Phinney Ridge</u> • <u>Madison-Miller</u> • <u>Morgan Junction</u> • <u>Upper Queen Anne</u> • <u>Wallingford</u> 		
<p><i>*Percentage growth above the actual number of housing units or jobs in 2015, <u>except in urban villages where actual zoning capacity constrains percentage growth to less than shown in the table.</u> except where limited by zoning capacity. No job growth rate is assigned to residential villages.</i></p> <p><i>**Very good transit service means either a light rail station or a RapidRide bus service plus at least one other high-frequency frequent bus route.</i></p>		
188	On page 28, amend the Plan, as follows:	

Council's Amendment

Industrial job growth will continue to take place mostly within the City's two existing and well-established manufacturing/industrial centers. There will also be overall job growth in hub urban villages distributed throughout the city, which will put jobs and services closer to the surrounding residential population.

Urban villages that contain very good transit service are expected to grow more than those without that service. Very good transit means either a light rail station or a RapidRide stop plus at least one other frequent bus route. In May 2015, the City published a Growth and Equity Analysis to analyze impacts on displacement and opportunity related to Seattle's growth strategy. ~~Two~~ That analysis found that some urban villages—~~Rainier Beach and Othello~~—that have light rail stations also are at high risk of too much development displacing existing households or small businesses. The City wants these areas to benefit from growth and investment, but we also need to pay attention to how growth can increase the risk of displacing marginalized populations and small businesses. To mitigate the risk, the Plan assigns a growth rate to these urban villages that is the same as for the residential villages that do not meet the definition for very good transit service. As the City monitors urban village growth in the future, the smaller growth rates for these two urban villages will help us examine the potential for displacement. Growth Strategy Figure 4 shows the different categories of urban villages, along with their level of transit service.

Attachment 5. Land Use Element Amendments

Council's Amendment	
19	<p>On page 43, amend Policy LU 3.2, as follows</p> <p>***</p> <p>LU 3.2 Allow public facilities and small institutions to depart from development standards, if necessary to meet their particular functional requirements, while maintaining general design compatibility with the surrounding area's scale and character. Require public facilities and small institutions to adhere to zoned height limits, except for schools and spires on religious institutions. <u>Consider providing greater flexibility for schools in recognition of their important role in the community.</u></p> <p>***</p>
20	<p>On page 46, replace Policy LU 5.8, as follows</p> <p>***</p> <p>LU 5.8 Use landscaping requirements and other tools to limit impacts on the natural environment, including increasing stormwater infiltration where appropriate.</p> <p><u>LU 5.8 Establish tree and landscaping requirements that preserve and enhance the City's physical and aesthetic character and recognize the value of trees and landscaping in addressing stormwater management, pollution reduction, heat island mitigation, and other issues.</u></p> <p>***</p>
21	<p>On page 47, amend Goal LU G6, as follows</p> <p>***</p> <p>LU G6 Regulate off-street parking to address parking demand in ways that reduce reliance on automobiles, <u>improve public health and safety, reduce greenhouse gas emissions,</u> lower construction costs, create attractive and walkable environments, and promote economic development throughout the city.</p>
22	<p>On page 48, amend Policy LU 6.6, as follows</p> <p>***</p> <p>LU 6.6 Limit the off-street impacts on pedestrians and surrounding areas by restricting the number and size of automobile curb cuts, and by generally requiring alley access to parking when there is an accessible, surfaced alley. that is not used primarily for loading and when not prevented by topography.</p>
23	<p>On page 48, amend Policy LU 6.10, as follows</p>

Council's Amendment

LU 6.10 Allow ~~parking~~ transportation management provisions programs in select commercial and multifamily residential areas with access to frequent transit to include measures such as cooperative parking, shared parking, shared vehicles, restricted access, car pools, van pools, or transit pass subsidies.

24 On page 48, amend Policy LU 6.13, as follows

LU 6.13 Limit parking in City parks to discourage ~~auto use and to limit~~ the use of park land for parking ~~private cars~~; where there is a demonstrated need for parking is needed, design parking facilities in ways that preserve open space, green space, and trees and other mature vegetation.

25 On page 50, amend Policy LU 7.2, as follows

LU 7.2 Use a range of single-family zones to

- maintain the current low-height and low-bulk character of single-family areas;
- ~~Protect designated~~ limit development in single-family areas ~~that are predominantly in single-family residential use or~~ that have environmental or infrastructure constraints;
- allow different densities that reflect historical development patterns; and
- respond to neighborhood plans calling for redevelopment or infill development that maintains the single-family character of the area but also allows for a greater range of housing types.

26 On page 50, amend Policy LU 7.3, as follows

LU 7.3 Consider allowing redevelopment or infill development of single-family areas inside urban centers and villages, where new development would maintain the low height and bulk that characterize the single-family area, while allowing a wider range of housing types such as detached accessory units, cottage developments or small duplexes or triplexes.

Council's Amendment	

27	<p>On page 51, amend Policy LU 7.5 as follows</p> <p>***</p> <p>LU 7.5 Encourage accessory dwelling units, <u>family-sized units</u>, and other housing types that are attractive and affordable to a broad range of households and incomes, and that are compatible with the development pattern and building scale in single-family areas <u>in order to make the opportunity in single-family areas more accessible to a broad range of households and incomes, including lower-income households.</u></p> <p>***</p>
28	<p>On page 52, amend Goal LU G8, as follows</p> <p>LU G8 Allow a variety of housing types and densities that is suitable for a wide range <u>broad array</u> of households and income levels, including opportunities for both homeownership and renting, and that promotes walking and transit use near employment concentrations, residential services, and amenities.</p>
29	<p>On page 52, amend Policy LU 8.9, as follows</p> <p>LU 8.9 Establish lowrise multifamily zones to accommodate various housing choices in the low- to moderate-density range <u>suitable for a broad array of households and incomes,</u> including walk-up apartments, town houses, row houses, duplexes, triplexes, and cottage housing.</p>
30	<p>On page 54, amend Policy LU 9.7, as follows</p> <p>***</p> <p>LU 9.7 Provide opportunities for small local businesses to locate, especially in ethnically <u>culturally</u> relevant business districts throughout the City <u>city.</u></p> <p>***</p>
31	<p>On page 55, amend Policy LU 9.12, as follows</p> <p>***</p> <p>LU 9.12 Consider allowing <u>Allow</u> street-level residential uses outside pedestrian-oriented areas and, when street-level residential uses are permitted, <u>identify ways apply standards that</u> to give ground-floor tenants privacy and to create visual interest along the street front.</p> <p>***</p>

Council's Amendment

32 On page 56, add new policy LU 9.24, as follows

LU 9.24 Explore tools to encourage the creation of small commercial spaces in new development that can accommodate small, local, and culturally relevant businesses, particularly those businesses threatened with displacement.

159 On page 46, amend Policy LU 5.16, as follows

LU 5.16 Require higher-density development to offset its impacts through mechanisms such as incentives for landmark preservation, open space amenities, ~~and~~ affordable housing and affordable commercial space.

160 On page 56, amend Policy LU 9.23, as follows

LU 9.23 Use zoning and other planning tools in urban centers and urban villages to address displacement of small locally-owned businesses that reinforce local neighborhood and cultural identity and provide culturally relevant goods and services to Seattle's diverse population.

161 On page 59, add new policies LU 10.26 through LU 10.28 from the current Comprehensive Plan's Land Use Element, as follows

LU 10.26 Restrict or prohibit uses that may negatively affect the availability of land for industrial activity, or that conflict with the character and function of industrial areas.

LU 10.27 Consider high value-added, living wage industrial activities to be a high priority.

LU 10.28 Permit commercial uses in industrial areas to the extent that they reinforce the industrial character, and limit specified non-industrial uses, including office and retail development, in order to preserve these areas for industrial development.

Council's Amendment

162 On pages 64 and 65, amend the "Historic Districts" section (Goal LU G14 and policies LU 14.1 through LU 14.8), adding new goals and policies and amending the Plan, as follows

~~Historic Districts and Landmarks~~ Preservation and Cultural Resources

Discussion

Historic preservation recognizes and protects aspects of our shared cultural heritage— buildings, districts, and designed landscapes that link to Seattle's past. From the Native Americans who first established trading centers along the Duwamish River to the latest waves of newcomers from around the world, all have left their mark. Over time, Seattle has acquired historic features that have become part of the city's civic identity.

Through the preservation of icons and historic locations such as the Space Needle, the Olmsted network of parks and boulevards, and Pioneer Square, the city can continue to celebrate its heritage and maintain its unique sense of place.

Seattle values its past and recognizes and protects its heritage. One way we do this is by calling out more than 450 buildings, objects, and sites of exceptional significance, and eight historic districts. These visible connections to the past strengthen our sense of place and help build community. Finding new uses for existing structures also helps achieve the City's goals for sustainable development, because reusing historic buildings is more sustainable than demolishing and replacing them. Preserving and restoring historic buildings can encourage other revitalization in the neighborhood and attract new businesses.

The benefits of historic preservation are not merely aesthetic. Preservation is integral to our economic-development , and it also enhances our city's identity as a center for tourism, itself an important source of local jobs. Preserving historic buildings can help incubate small locally-owned businesses, revitalize commercial districts, and generate local jobs. Historic preservation promotes sustainability through the reuse, repair, and upgrading of existing built resources.

GOAL

LU G14 Maintain the city's cultural identity and heritage.

POLICIES

LU 14.1 Maintain a comprehensive survey and inventory of Seattle's historic and cultural resources. Update the survey and inventory when developing a new community plan or updating an existing plan, as appropriate.

~~LU 14.1~~ 14.2 Support the designation of areas as historic and special review districts, and the designation of structures, sites, and objects as City of Seattle landmarks in

Council's Amendment

order to protect, enhance, and perpetuate their historical or architectural identities.

~~LU-14.2~~14.3 Tailor development standards and design review processes specifically for a special review district to describe design-related features allowed, encouraged, limited, or excluded from the district. Allow adopted guidelines to modify, exempt, or supersede the underlying zone's standards.

~~LU-14.3~~14.4 Encourage the adaptive reuse of designated landmark structures by allowing uses in these structures that may not otherwise be allowed under the applicable zoning, provided such action is approved by the Landmarks Preservation Board.

~~LU-14.4~~14.5 Use incentives, including the transfer of development rights, to encourage property owners and developers to restore or reuse designated landmark structures and specified structures in designated districts.

~~LU-14.5~~14.6 Consider the use of conservation districts to recognize and sustain the character of unique residential or commercial districts.

~~LU 14.6~~14.7 Protect the scale and character of the established development pattern, while encouraging compatible and context-sensitive infill development.

LU 14.8 Expand outreach mechanisms to encourage historic preservation projects in neighborhoods and communities that have not traditionally benefited from historic preservation efforts, with particular focus on areas with high concentrations of under-served and/or under-represented people.

~~LU 14.7~~14.9 Identify historic resources that can be successfully used to meet the city's housing goals.

~~LU 14.8~~14.10 Identify, preserve, and protect archaeological resources.

GOAL

LU G15 Promote the economic opportunities and benefits of historic preservation.

POLICIES

LU 15.1 Recognize the economic value of Seattle's historic resources in attracting tourism; encourage reinvestment of a share of the revenue derived from tourism to sustain and expand historic preservation.

LU 15.2 Encourage rehabilitation opportunities and reinvesting in vacant or underutilized historic properties to spark economic revitalization.

LU 15.3 Encourage rehabilitation of existing housing units and other building types that expands affordable housing choices and contributes to market-rate and workforce housing.

Council's Amendment

LU 15.4 Explore and provide various financial and regulatory incentives, if possible, to allow for the productive, reasonable, and adaptive reuse of historic resources.

GOAL

LU G15 Promote the environmental benefits of preserving and adaptively reusing historic buildings.

POLICIES

LU 16.1 Encourage rehabilitation and adaptive reuse of buildings to conserve resources, reduce waste, and demonstrate stewardship of the built environment.

LU 16.2 Promote seismic and energy efficiency retrofits of historic buildings to reduce carbon emissions, save money, and improve public safety.

LU 16.3 Encourage the creation of ecodistricts to achieve sustainability and resource efficiency at a district scale.

renumber Goal LU G15 (Environmentally Critical Areas) as LU G17 and Policies LU 15.1 through LU 15.26 as Policies LU 17.1 through 17.26

Attachment 6. Transportation Element Amendments

Council's Amendment

33 On pages 71-72, amend Transportation Figure 1, as follows

Transportation Figure 1

Mode-Share Targets for All Work Trips* to Seattle and Its Urban Centers

Percentage of work trips made by travel modes other than driving alone

Area	2014	2035 Target
Downtown	77%	85%
First Hill/Capitol Hill	58%	70%
Uptown	48%	60%
South Lake Union	67%	80%
University District	73%	85%

Area	2014	2035 Target
Northgate	30%	50%
Seattle	57%	65%

*work trips terminating in the city or urban center

34 On page 72, amend Transportation Figure 2, as follows

Transportation Figure 2

Mode-Share Targets for Residents of Seattle and Its Urban Centers

Percentage of non_work* trips made using travel modes other than driving alone

Area	2014	2035 Target
Downtown	88%	90%
First Hill/Capitol Hill	80%	85%
Uptown	82%	85%

Council's Amendment		
	South Lake Union	76% 85%
	University District	79% 90%
	Northgate	46% 55%
	Seattle	67% 75%
<p><u>* non-work trips that have both their origin and destination within the city or urban center</u></p>		
35	<p>On page 72, add new policy T 1.7, as follows</p> <p>***</p> <p><u>T 1.7 Recognize the connection between transportation choices and climate change and work to reduce vehicular emissions.</u></p> <p>***</p>	
36	<p>On page 73, amend Policy T2.2, as follows</p> <p>***</p> <p>T 2.2 Ensure that the street network accommodates multiple travel modes, including transit, freight movement, pedestrians, <u>people with disabilities</u>, bicycles, general purpose traffic, and shared transportation options.</p> <p>***</p>	
37	<p>On page 73, amend Policy T 2.5, as follows</p> <p>***</p> <p>T 2.5 Prioritize mobility needs in the street travelway based on safety concerns and <u>then</u> on the recommended networks and facilities identified in the respective modal plans.</p> <p>***</p>	
38	<p>On page 74, amend Policy T 2.8, as follows</p> <p>***</p> <p>T 2.8 Employ the following tactics to resolve potential conflicts for space in the right-of-way:</p> <ul style="list-style-type: none"> • <u>Implement transportation and parking-demand management strategies to encourage more efficient use of the existing right of way</u> 	

Council's Amendment

- Allocate needed functions across a corridor composed of several streets or alleys, if all functions cannot fit in a single street
- Share space between travel modes and uses where safe and where possible over the course of the day
- Prioritize assignment of space to shared and shorter-duration uses
- Encourage off-street accommodate for non-mobility uses, including parking and transit layover
- ~~Implement transportation and parking demand management strategies to encourage more efficient use of the existing right-of-way~~

39 On page 75, amend the Plan, as follows

The plans that the City has developed for individual travel modes (pedestrian, bicycle, and transit) include strategies and projects that will improve transportation choices in the city. These include the Pedestrian Master Plan, the Bicycle Master Plan, and the Transit Master Plan.

40 On page 81, amend Policy T 3.7, as follows

T 3.7 Optimize operations of bus rapid transit, RapidRide, and streetcar corridors by adjusting signals and ~~consider~~ providing exclusive transit lanes to promote faster travel times for transit than for automobile travel.

41 On page 81, amend Policy T 3.7 as follows

T 3.7 Optimize operations of bus rapid transit, RapidRide, and streetcar corridors by adjusting signals and ~~consider~~ providing exclusive transit lanes to promote faster travel times for transit than for automobile travel.

42 On page 81, add new policy T 3.8, as follows



Council's Amendment	
	<p><u>T 3.8 Work with transportation providers, such as car share, bike share and taxi providers, to provide access to their services throughout the city and to maintain the affordability of their services.</u></p> <p>***</p> <p>Then renumber Policy T 3.8 and subsequent policies, accordingly.</p>
43	<p>On page 82, add a new policy T 3.21, as follows</p> <p>***</p> <p><u>T 3.21 Assess the affordability and accessibility of existing and potential transportation options in order to better inform decisions affecting the equitable provision of transportation services.</u></p>
44	<p>page 83</p> <p>***</p> <p>T 4.4 Work to <u>Manage the transportation system to support modes that</u> reduce the use of fossil fuels and promote the use of alternative fuels.</p> <p>***</p>
45	<p>On page 84, replace Figure 8 with the new Figure 8, labeled Freight Network, as shown below. Also, rename the figure as <u>Freight Network</u>.</p>

Council's Amendment

New Figure 8

Freight Network

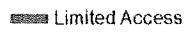
Seattle Freight Network

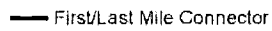
-  Limited Access
-  Major
-  Minor
-  First/Last Mile Connector

Source: Seattle Freight
Master Plan



0 0.5 1 2
Miles

© 2016 City of Seattle

No warranties of any sort, including accuracy,
fitness or merchantability, accompany this
product.

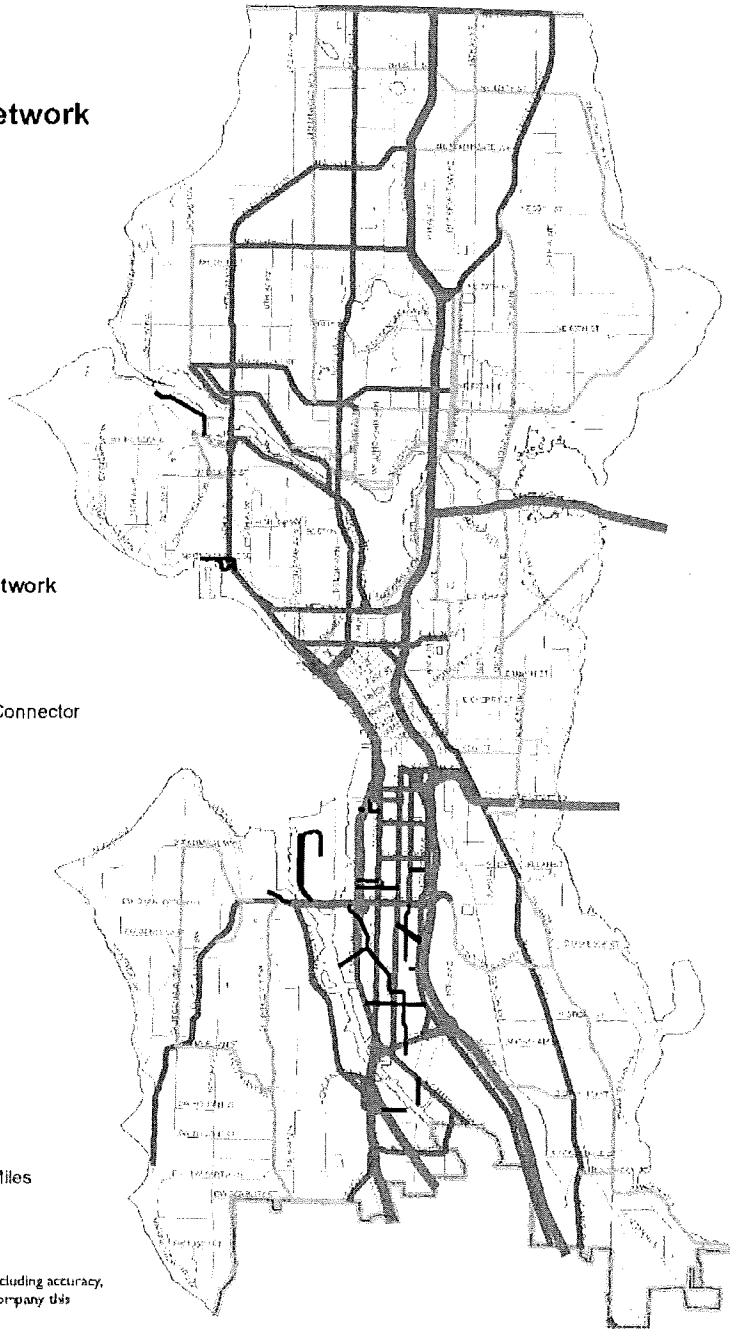

Council's Amendment	
46	<p>On page 86, add a new Policy T 5.11, as follows</p> <p>***</p> <p><u>T 5.11 Explore freight demand management strategies that could consolidate freight delivery trips and encourage vehicles are sized appropriately for an urban environment.</u></p> <p>***</p>
47	<p>On page 86, amend Policy T 6.1, as follows</p> <p>***</p> <p>T 6.1 Reduce collisions for all modes of transportation and work toward a transportation system that produces zero fatalities and serious injuries <u>by 2030</u> to attain the City's Vision Zero objectives.</p> <p>***</p>
48	<p>On page 86, amend Policy T 6.8, as follows</p> <p>***</p> <p>T 6.8 Emphasize safety as a consideration <u>Make safety a priority</u> in all transportation plans and projects, including project prioritization criteria.</p> <p>***</p>
49	<p>On page 88, add new policy T 7.9, as follows</p> <p>***</p> <p><u>T 7.9 Work with neighboring jurisdictions and King County to integrate the city's bicycle network, developed as part of the Bicycle Master Plan, with regional bicycle facilities.</u></p> <p>***</p>
50	<p>On page 90, amend Policy T 9.2, as follows</p> <p>***</p> <p>T 9.2 Provide a menu of transportation – demand management tools for future development to meet non-drive-alone mode share targets, <u>provision of transit passes, carpool benefits, and improvements to pedestrian and bicycle facilities.</u></p> <p>***</p>
51	<p>On page 90, amend Policy T 9.3, as follows</p>

Council's Amendment	
	<p>***</p> <p>T 9.3 Pursue strategies to reduce drive-alone trips in order to increase the ability of the city's transportation network to carry people <u>and goods</u>.</p> <p>***</p>
52	<p>On page 90, amend Policy T 9.4, as follows</p> <p>***</p> <p>T 9.4 Assess the mode share LOS standards over time <u>and adjust as necessary needed</u>, based on review of other City transportation measures.</p> <p>***</p>
53	<p>On page 91, add new policy T 10.11, as follows</p> <p>***</p> <p><u>T10.11 Explore innovative means of reducing maintenance costs such as converting right-of-way into other uses when appropriate.</u></p> <p>***</p>
181	<p>On page 46, amend policy T 3.11 to restore language from the current Comprehensive Plan (Policy T 30.5)</p> <p>***</p> <p>T 3.11 Look for opportunities to reestablish or improve connections across I-5 by creating new crossings, or enhancing streets where I-5 crosses overhead, <u>or constructing lids</u>, especially where these can also enhance opportunities for development or open space.</p> <p>***</p>
189	<p>On page 41, amend Policy LU 1.3, as follows</p> <p>***</p> <p>LU 1.3 Provide for a wide range in the scale and density permitted for multifamily residential, commercial, and mixed-use projects to generally achieve the following overall density and scale characteristics, <u>consistent, at a minimum, with the guidelines in Growth Strategy Figure 1</u>:</p> <ul style="list-style-type: none">• In urban centers, a moderate to high-density and scale of development• In hub urban villages, a moderate density and scale of development

Council's Amendment

- In residential urban villages, a low to moderate density and scale of development
- Consider higher densities and scales of development in areas near light rail stations

190 On page 40, replace the Future Land Use Map with a new version of the map that does not include "potential urban village expansion" areas, as shown below

Council's Amendment

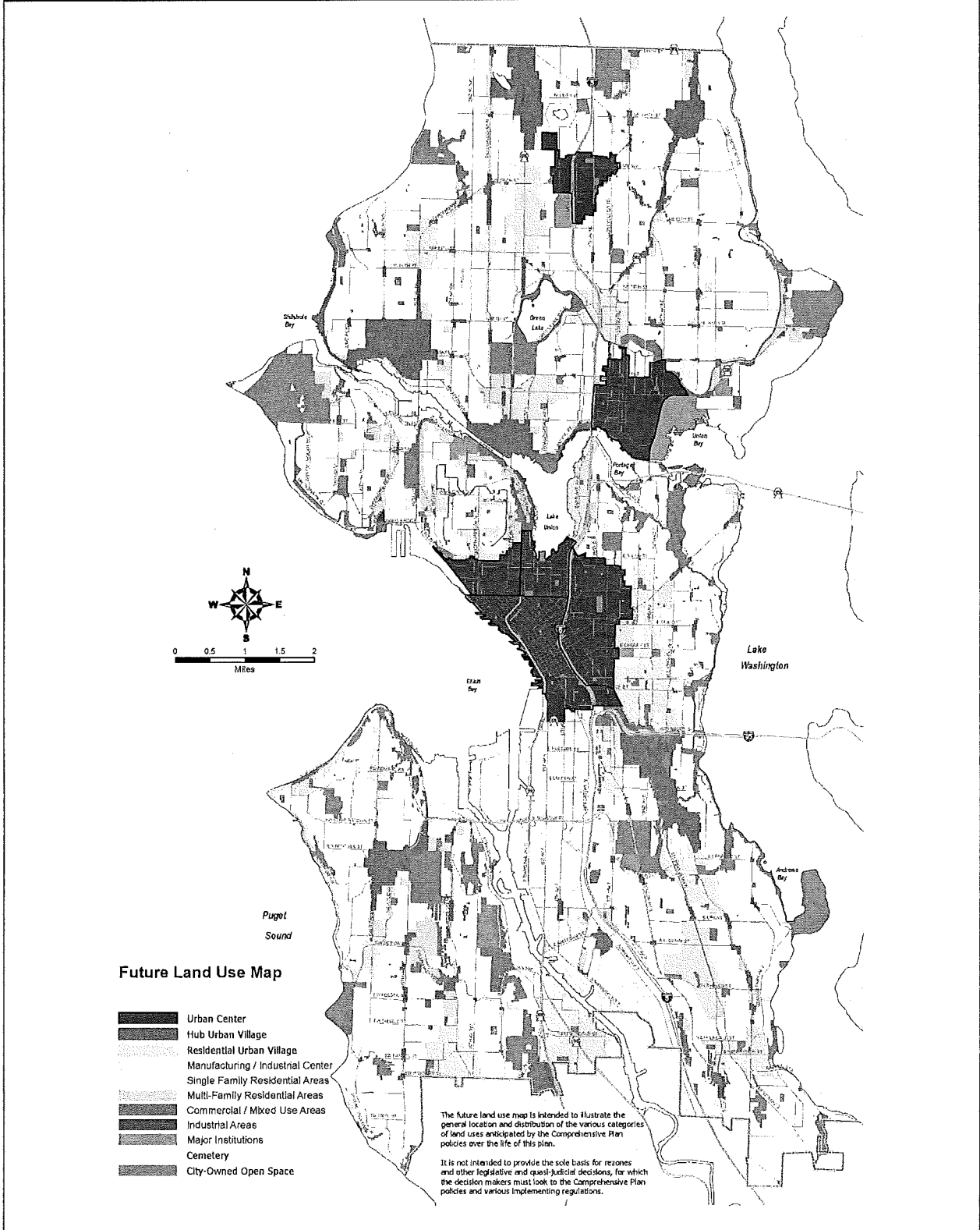

Attachment 7. Housing Element Amendments

Council's Amendment	
54	<p>On page 94, amend the Plan, as follows</p> <p>***</p> <p>This Housing element establishes goals and policies to address the housing needs of all Seattleites. Together, these goals and policies will contribute to building vibrant, resilient, and cohesive communities throughout our city. These goals and policies are grouped within the following five topic areas: Equal Access to Housing, Supply of Housing, Diversity of Housing, Housing Construction and Design, and Housing Affordability. <u>The policies of the Housing element are interdependent with other elements of this Plan, especially the Growth Strategy element calling for most growth in urban centers and villages, and the Land Use element guiding the available places in Seattle for residential uses.</u></p> <p>Various policies in this element refer to “rent/income-restricted housing.” This means housing with conditions that legally restrict the income of the tenants who live there and the rents they may be charged. When this Plan refers to “affordable housing,” it generally means housing that lower-income households can afford without sacrificing essential needs like food and health care. Affordable housing includes rent/income restricted housing, as well as housing that is low cost without any subsidy or incentive.</p> <p>***</p>
55	<p>On page 95 and throughout the Plan</p> <p>Replace “fair-housing” with “fair housing” throughout all discussion and policy sections of the Plan.</p>
56	<p>On page 95, amend Goal HG1, as follows</p> <p>***</p> <p>HG1 Help all people have <u>Provide</u> fair and equal access to housing <u>for all people in</u> Seattle.</p> <p>***</p>
57	<p>On page 96, amend Policy H 1.3, as follows</p> <p>***</p> <p>H 1.3 Encourage actions, such as affirmative marketing and fair housing education and enforcement, to overcome <u>Work to</u> overcome historical patterns of segregation, promote fair housing choices, and foster inclusive communities that are free from</p>

Council's Amendment

discrimination through actions, such as affirmative marketing and fair housing education and enforcement.

58 On page 96, amend the Plan as follows

In 2013, The City Council undertook a review of the city's affordable housing incentive programs. The Council commissioned reports on national best practices and new strategies to increase housing affordability in Seattle. In 2014, The Council and Mayor jointly convened the Seattle Housing Affordability and Livability Agenda (HALA) Advisory Committee. In 2015, the mayor and Council announced approved the Seattle Housing Affordability and Livability Agenda

(HALA). The HALA contains sixty-five recommendations for how Seattle can accommodate more housing. It includes steps that will help both for-profit and nonprofit housing developers build and preserve affordable housing. The HALA outlines a road map to build or preserve fifty thousand housing units over the next ten years, including twenty thousand units of rent/income-restricted housing.

In 2016, the City published a report titled Growth and Equity. That report compiles data about several economic and demographic factors that help identify places in the city where residents, especially people of color and low-income residents, could be at risk of displacement or where there is less access to employment and other opportunities. As housing development continues, the City will promote policies that limit displacement, stabilize marginalized populations in their communities, and encourage a net increase in affordable housing over time.

59 On page 96, add a new Policy H 1.6, as follows

H 1.6 Work to decrease disparities in homeownership by race and ethnicity.

60 On page 97 amend Policy H 2.2 by deleting the first comma, as follows

H 2.2 Identify publicly owned sites suitable for housing, and prioritize use of sites, where appropriate, for rent/income-restricted housing for lower-income households.

Council's Amendment	

61	On page 97, amend Policy H 2.5, as follows *** H 2.5 <u>Monitor the supply of housing and encourage</u> Encourage the replacement of housing that is demolished or converted to nonresidential or higher-cost residential use. ***
62	On page 98, amend Policy H 4.2, as follows *** H 4.2 Encourage innovation in residential design, construction, and technology, and implement regulations to conserve water, energy, and materials; ; reduce greenhouse gas emissions; ; and otherwise limit environmental and health impacts. ***
63	On page 99, amend Policy H 4.8 by deleting the hyphen in "housing-development", as follows H 4.8 Explore ways to reduce housing_ development costs.
64	On page 100, amend the Plan to remove a hyphen in "housing-affordability", as follows *** Seattle in 2016 is in the midst of a housing_ affordability crisis. The goals and policies in this Housing Affordability section help establish a framework for making Seattle a more affordable and equitable city. ***
65	On page 102. add new policy H 5.25, as follows *** H 5.25 <u>Work to mitigate the potential demolition of housing units that are affordable to low-income households without subsidies.</u> ***
163	On page 96, add new Policy H 1.7, as follows *** H 1.7 <u>Support the development and preservation of affordable housing in areas with a high risk of displacement through tools and actions such as land banking, public or</u>

Council's Amendment	
	<p><u>non-profit acquisition of affordable buildings, and new affordable and mixed-income development.</u></p> <p>***</p>
164	<p>On page 96, amend Goal H G2, as follows</p> <p>***</p> <p>H G2 Help meet current and projected regional housing needs of all economic and demographic groups by increasing Seattle's housing supply. Strive to add or preserve fifty thousand housing units by 2025, including twenty thousand rent/income restricted housing units.</p>
165	<p>On page 97, add a new Policy H 2.6, as follows</p> <p>***</p> <p><u>H 2.6 Seek to identify affordable housing at risk of demolition and work to mitigate the displacement of residents ahead of planned upzones.</u></p> <p>***</p>
166	<p>On page 101, amend Policy H 5.7, as follows</p> <p>***</p> <p>H 5.7 Consider access to high-frequency <u>frequent</u> transit may lower the combined housing and transportation costs for households when locating housing for lower-income households.</p>
167	<p>On page 102, do not amend policy H 5.24, instead add new policy H 5.25, as follows</p> <p>***</p> <p>H 5.24 Support financially sustainable strategies to provide homeownership opportunities for low-, moderate-, and middle-income households, especially for families with children, in part to enable these households to have a path toward wealth accumulation.</p> <p><u>H 5.25 Explore implementation of models that could provide opportunities for affordable homeownership, such as community land-trusts, down payment assistance, mixed-income housing requirements and limited equity housing co-ops.</u></p> <p>***</p>
182	<p>On page 97, add a new policy H 2.7, as follows</p> <p>***</p>

Council's Amendment

H 2.7 Evaluate the City's efforts to mitigate displacement of affordable housing.

Attachment 8. Capital Facilities Element Amendments

Council's Amendment	
66	<p>On page 104, amend the Plan, as follows</p> <p>***</p> <p>Over the next twenty years, the City will aim to ensure that Seattle's capital facilities and programming</p> <ul style="list-style-type: none">• contribute to a high degree of personal and public health and safety;• are equitably distributed based upon <u>Seattle's Race and Social Justice principles and</u> the different needs of individuals and communities; <p>***</p>
67	<p>On page 105, amend Policy CF 1.1, as follows</p> <p>***</p> <p>CF 1.1 Assess the policy and fiscal implications of potential major capital facility investments as part of the City's capital decision-making process. The evaluation should include consideration of a capital project's</p> <ul style="list-style-type: none">• consistency with the Comprehensive Plan and functional plans;• effects on Seattle's environmental, social, economic, and human health over the lifetime of the investment;• contributions to an equitable distribution of facilities and services <u>especially to correct historic under-investment in low-income areas</u>;• ability to support urban centers and villages that are experiencing or expecting high levels of residential and employment growth <u>or those with lower access to the benefits of City-sponsored capital facilities</u>; and• total costs of ownership over a project's life, including construction, operation, maintenance, and decommissioning.
68	<p>On page 109, amend CF 5.2 as follows</p> <p>***</p> <p>CF 5.2 Work with other public or nonprofit agencies to identify and pursue new colocation, and joint-use <u>and temporary use</u> opportunities in public facilities for community programs, services, <u>performances, exhibits</u> and meetings.</p> <p>***</p>
69	<p>On page 109, amend Policy CF 5.3, as follows</p>

Council's Amendment

CF 5.3 Partner with Seattle Public Schools to plan for expected growth in student population, explore opportunities to reduce the costs of developing new schools, encourage the siting of new school facilities in or near urban centers and villages, and make it easy for students and families to walk and bike to school.

70 On page 104, amend Policy CF 5.3, as follows

Achieving this vision will enable the City to create a capital facilities system that is an exceptional resource for all Seattleites. Part of the challenge in achieving the vision will be in recognizing and serving the disparate needs of different portions of the population.

An inventory of existing capital facilities owned by public entities and a forecast of the future needs for such capital facilities are including in the Capital Facilities Appendix. Detailed information about specific planned capital facility improvements, including the proposed locations and capacities of expanded or new capital facilities and a six-year plan for financing these improvements, is contained in Seattle's Capital Improvement Program (CIP), which is updated as part of the City's annual budget process.

168 On page 109, add a new policy CF 4.8, as follows

CF 4.8 Seek to mitigate impacts of City projects on adjacent communities, especially lower-income residents and small locally-owned businesses, in order to reduce the possibility of displacement.

Attachment 9. Utilities Element Amendments

Council's Amendment	
71	<p>On page 115, amend Policy U 2.5, as follows</p> <p>***</p> <p>U2.5 Pursue the long-term goal of diverting most of the city's solid waste away from landfills by increasing recycling, <u>composting</u>, reducing consumption, and promoting products that are made to be reused, repaired, or recycled back into nature or the marketplace.</p>
72	<p>On page 115, add a new Policy U 2.9, as follows</p> <p>***</p> <p><u>U 2.9 Monitor waste reduction programs and develop new strategies when goals are not being met.</u></p> <p>***</p>
73	<p>On page 113, amend the Plan as follows</p> <p>***</p> <p>The Utilities element of this Plan outlines goals and policies that will guide City decisions about providing and updating services. It also addresses emerging issues that utilities face. <u>Seattle City Light and Seattle Public Utilities periodically prepare strategic plans that guide the work of the utilities consistent with this Plan.</u> An inventory of existing infrastructure as well as the forecasted future needs for City-owned utilities are discussed in this element's appendix...</p> <p>***</p>
74	<p>On page 114, amend Policy U 1.3, as follows</p> <p>***</p> <p>U 1.3 Strive to develop a resilient utility system where planning and investment decisions account for changing conditions, such as climate change, <u>fluctuations in demand</u>, technological changes, increased solar energy generation, and natural disasters.</p> <p>***</p>
75	<p>On page 115, amend Policy U 2.2 as follows</p> <p>***</p> <p>U 2.2 Consider short-term and long-term environmental and <u>race and social equity</u> impacts related to acquiring and using natural resources.</p>

Council's Amendment	

76	On page 115, amend Policy U 2.4, as follows *** U 2.4 Strive to be carbon neutral in the delivery of drinking water, drainage, sewer, and solid waste services, <u>both directly and through partnerships with private utilities and vendors.</u> ***
77	On page 115, amend Policy U 2.7, as follows *** U 2.7 Provide opportunities for marginalized populations to participate in conservation programs <u>provided by the city's utilities and through partnerships with private utilities and vendors.</u> ***
78	On page 116, amend Policy U 3.7, as follows *** U 3.7 Consider <u>and address</u> the disproportionate impacts of climate change on communities of color and lower-income communities when prioritizing projects. ***

Attachment 10. Economic Development Element Amendments

Council's Amendment	
79	<p>On page 121, amend the Plan as follows</p> <p>***</p> <p>Seattle enjoys an attractive, flourishing Downtown core that houses about 30 percent of all jobs within the city. Outside of Downtown. ... This is where small businesses thrive, communities come together, and many local jobs are created. About 12 percent of Seattle's jobs are located in these areas. <u>The Equitable Development Implementation Plan is one of the tools that the City is using to implement the policies in this section.</u></p> <p>***</p>
80	<p>On page 121, add a new policy ED 1.8, as follows</p> <p>***</p> <p><u>ED 1.8 Support formation of Business Improvement Areas to help provide clean and safe services, marketing and promotion, business and economic development planning, community appearance and pedestrian environment, urban design, advocacy, and organizational development/administration in commercial districts.</u></p> <p>***</p>
81	<p>ON page 123, add a new policy ED 3.8, as follows</p> <p>***</p> <p><u>ED3.8 Recognize and maintain a high-quality of life for all residents as one of Seattle's competitive advantages.</u></p> <p>***</p>
82	<p>On page 124, add a new policy ED 4.7, as follows</p> <p>***</p> <p><u>ED 4.7 Support efforts to provide training and job placement for older workers and others who may have unique challenges finding employment.</u></p> <p>***</p>
83	<p>On page 124, add a new policy ED 4.8, as follows</p> <p>***</p>

Council's Amendment

ED 4.8 Work with the local community in areas with low access to opportunities to provide training and education opportunities such as culturally relevant early learning training, community college centers and food industry training.

169 On page 121, amend policies ED 1.3 through ED 1.6, as follows

ED 1.3 Prioritize assistance to commercial districts in areas of lower economic opportunity with high concentrations of small locally-owned businesses.

ED 1.4 Enrich the vibrancy of neighborhood business districts through the integration of design, public art, public space, historic preservation, small locally-owned businesses and cultural spaces and programming.

ED 1.5 Support ~~independently owned and operated retail and restaurants~~ small locally-owned businesses in commercial districts to reinforce local neighborhood and cultural identity and strengthen the local economy.

ED 1.6 Pursue strategies for community development that help meet the needs of marginalized populations in multicultural business districts, ~~where~~ to reinforce local neighborhood and cultural identity by preserving small locally-owned businesses are at risk of displacement due to increasing costs.

170 On page 121, add a new policy ED 1.7, as follows

ED 1.7 Seek new tools to support the creation of spaces attractive and affordable to businesses threatened with displacement so that small locally-owned businesses are able to remain in their neighborhoods.

171 On page 122, add a new policy ED 2.6, as follows

ED 2.6 Seek to identify and support innovative small locally-owned businesses that could form new industry clusters.

172 On page 123, add a new policy ED 3.9, from the current Comprehensive Plan's Economic Development Element, as follows

Council's Amendment

ED3.9 Support the retention and growth of the industrial sector, retain existing businesses and small firms, and actively seek to attract new industrial businesses.

173 On page 124, amend Policy ED 4.3, as follows

ED 4.3: Encourage all businesses to pay a living wage, provide necessary employment benefits, and train and hire local residents so that the existing workforce can share in the city's prosperity.

Attachment 11. Environment Element Amendments

Council's Amendment	
84	<p>On page 127, amend the Plan, as follows</p> <p>***</p> <p>This element of the Plan contains goals and policies that are relevant to all other elements of this Plan. And other elements also touch on environmental policies specific to those topics... or improve outcomes for the environment. <u>Significant among Seattle's efforts to implement environmental policies is the Equity and Environment Initiative, a partnership of the City, the community, several City departments, and private foundations to deepen Seattle's commitment to race and social justice in environmental work.</u></p> <p>***</p>
85	<p>On page 131, amend Policy EN 3.1, as follows</p> <p>***</p> <p>EN 3.1 Expand transit, walking, bicycling, and shared-transportation infrastructure and services to provide safe, <u>affordable</u> and effective options for getting around that produce low or zero emissions, <u>particularly for lower-income households and communities of color.</u></p> <p>***</p>
86	<p>On page 131, amend Policy EN 3.2, as follows</p> <p>***</p> <p>EN 3.2 Aspire to <u>Implement the urban village strategy with the goal of meeting the growing demand for conveniently located homes and businesses in pedestrian-friendly neighborhoods where residents can walk to a variety of recreation and service offerings, in order to increase the number of trips that do not require automobile use and increase access to opportunity for lower-income households and communities of color.</u></p> <p>***</p>
87	<p>On page 131, amend Policies EN 4.2 and 4.3, as follows</p> <p>***</p> <p>EN 4.2 Prioritize actions that reduce risk and enhance resilience in populations nearest the likely impacts of climate change, including <u>actions that are driven by the communities most impacted by climate change.</u></p> <p><u>EN 4.3 Focus strategies to address the impacts of climate change, in particular, on the needs of especially marginalized populations and seniors, since these groups</u></p>

Council's Amendment	
	<p>often have the fewest resources to respond to changing conditions and therefore may be more severely impacted.</p> <p>***</p>
88	<p>On page 131, add new policy EN 4.4, as follows</p> <p>***</p> <p><u>EN 4.4 Partner with communities most impacted by climate change to identify local community assets, including infrastructure, cultural institutions, community centers, and social networks that can be supported and leveraged in adaption planning.</u></p> <p>***</p>
89	<p>On page 132, add new policy EN 5.5, as follows</p> <p>***</p> <p><u>EN 5.5 Work towards achieving racial and social equity in health outcomes so that members of all communities have the opportunity to live long healthy lives.</u></p> <p>***</p>
174	<p>On page 128, add a new policy EN 1.9, from the current Comprehensive Plan's Economic Development element, related to industrial areas as follows</p> <p>***</p> <p><u>EN 1.9 Work with other levels of government and with the private sector to support and encourage the cleanup of contaminated soil and other environmental remediation associated with the re-use or expansion of industrial sites.</u></p> <p>***</p>
183	<p>On page 129, add a new policy EN 2.7, as follows</p> <p>***</p> <p><u>EN 2.7 Work to identify and reduce flooding through improvements to drainage and wastewater systems and reductions in impervious surfaces and runoff, particularly in traditionally underserved areas.</u></p> <p>***</p>

Attachment 12. Parks and Open Space Element Amendments

Council's Amendment	
90	<p>On page 135, delete policy P 1.4 (see edits to P 1.12, line 106)</p> <p>***</p> <p>P 1.4 Reduce health disparities by making investments that provide access to open space and recreation activities for marginalized communities.</p> <p>***</p> <p>Renumber policies P 1.5 through P 1.15 as P 1.5 through P 1.14 consecutively</p>
91	<p>On page 136, amend Policy P 1.7 (renumbered from P 1.8), as follows</p> <p>***</p> <p>P 1.8<u>7</u> Encourage or require private developers to incorporate on-site publicly accessible open space or to provide appropriate recreation opportunities for building tenants within new developments.</p> <p>***</p>
92	<p>On page 136, amend Policy P 1.8 (renumbered from P 1.9), as follows</p> <p>***</p> <p>P 1.9<u>8</u> Consider the use of open space impact fees and other financing mechanisms to help fund open space system improvements that will serve the expected growth.</p> <p>***</p>
93	<p>On page 136, amend Policy P 1.11 (renumbered from P 1.12), as follows</p> <p>***</p> <p>P 1.12<u>11</u> Use <u>Make</u> investments in park facilities and programs to reduce health disparities by providing access to open space and recreational activities for all Seattle residents, <u>especially marginalized populations, seniors, and children.</u></p> <p>***</p>
94	<p>On page 136, amend Policy P 1.14 (renumbered from P 1.15), as follows</p> <p>***</p> <p>P 1.15<u>14</u> <u>Provide for</u> Consider access by transit, bicycle, and foot when acquiring <u>siting and designing</u> new park facilities or improving existing ones.</p> <p>***</p>
95	<p>On page 136, add a new Policy P 1.15, as follows</p>

Council's Amendment

P 1.15 Engage with community members to design and develop parks and facilities based on the specific needs and cultures of the communities the park is intended to serve.

96 Move Policy P 3.6 from page 138 to page 135, and renumber Policy 3.6 as Policy P 1.16

P 3.6 1.16 Increase access to public land by assessing, managing, and cleaning up contaminated sites.

Renumber Policy P 3.7 as P 3.6 and Policy P 3.8 as P 3.7 consecutively

175 On page 136, add a new policy P 1.17, as follows

P 1.17 Create innovative opportunities to use existing public land, especially in the right of way, for open space and recreation, including street plazas, pavement to parks, parklets, lidding of reservoirs and highways, and community gardens.

Attachment 13. Arts and Culture Element Amendments

Council's Amendment	
97	<p>On page 143, amend Policy AC 2.1 as follows</p> <p>***</p> <p>AC 2.1 Recognize and expand the economic impact of arts and culture. <u>Consider ways to support arts and culture as part of an economic development strategy.</u></p> <p>***</p>
98	<p>On page 143, amend Policy AC 2.3, as follows</p> <p>***</p> <p>AC 2.3 Encourage access to affordable workspaces for artists, <u>musicians</u>, arts, and cultural organizations.</p> <p>***</p>
99	<p>On page 143, amend Policy AC 2.4, as follows</p> <p>***</p> <p>AC 2.4 Improve technical-and financial-assistance programs to better target and serve both artists and arts organizations, <u>musicians and live music venues</u> of various sizes and at various stages of growth, representing a broad range of cultures. <u>Consider ways to make the City's funding programs more accessible to small, independent artists, musicians and arts organizations particularly from underrepresented communities.</u></p> <p>***</p>
100	<p>On page 143, add a new policy AC 2.2, as follows</p> <p>***</p> <p><u>AC 2.2 Recognize and regularly assess the economic impact of Seattle's music and nightlife sector.</u></p> <p>***</p> <p>renumber policies AC 2.2 through AC 2.5 consecutively</p>
101	<p>On page 143, add a new policy AC 2.7, as follows</p> <p>***</p> <p><u>AC 2.7 Work with public, not-for-profit and private organizations to support artists, arts organizations and cultural organizations to help them thrive.</u></p>

Council's Amendment	
102	<p>On page 144, Amend the title of Section 3 of the Element as follows</p> <p>***</p> <p><u>"Youth Development and Arts Education"</u></p> <p>***</p>
103	<p>On page 144, amend Goal AC G3, as follows</p> <p>***</p> <p>AC G3 Improve access to arts <u>and music</u> education in all schools and outside the school setting so that students are prepared to be successful in school and life.</p> <p>***</p>
104	<p>On page 144, amend Policy AC 3.3, as follows</p> <p>***</p> <p>AC 3.3 Expand partnerships with educational institutions, arts <u>and music</u> institutions, youth service agencies, libraries, foundations, businesses, and arts and cultural organizations to increase participation in arts, <u>music</u> and culture-cultural programs, creative learning opportunities, and creative economy careers.</p> <p>***</p>
105	<p>On page 144, amend Policy AC 3.4, as follows</p> <p>***</p> <p>AC 3.4 Help make arts <u>and music</u> education available in areas of high violence and poverty or where school performance is poor.</p> <p>***</p>
106	<p>On page 145, amend Policies AC 4.2 through AC 4.4, as follows</p> <p>***</p> <p>AC 4.2 Create incentives to preserve or expand space for artists, arts organizations, <u>musicians, and music organizations</u>, and other cultural uses.</p> <p>AC 4.3 Consider making surplus City-owned property available to both artists, <u>musicians</u>, and arts and cultural organizations.</p> <p>AC 4.4 Consider public-private partnerships as a way to provide affordable space to both artists and arts, <u>musicians</u>, and cultural organizations.</p> <p>***</p>

Council's Amendment

107 On page 146, amend Policy AC 4.11, as follows

AC 4.11 Enhance access to a variety of arts, music and cultural institutions and programs for at-risk youth, non-English-speaking residents, seniors, the visually and hearing impaired, and people with other disabilities.

108 page 146, add a new policy AC 4.12, as follows

AC 4.12 Recognize the importance of live music and entertainment venues to the vibrancy of the city's culture. Support the viability of these small businesses and nonprofits in areas undergoing development through policies that proactively engage and balance the interests of music venues and new residents.

176 On page 141, amend the Plan, as follows

Experiencing arts and culture should be fun and challenging. It should also be accessible so that it can be enjoyed regularly by all. There are so many ways to experience art. It can be created or observed or collaborated on. From tangible, physical objects, books, and digital works to experiences, gatherings, performances, and oral histories, the Seattle arts scene has many different points of entry. Cultural spaces are varied and can range from traditional theaters, galleries, and studios to schools, parks, libraries, and coffee shops.

~~Historic preservation recognizes and protects aspects of our shared cultural heritage— buildings, districts, and designed landscapes that link to Seattle's past. From the Native Americans who first established trading centers along the Duwamish River to the latest waves of newcomers from around the world, all have left their mark. Over time, Seattle has acquired historic features that have become part of the city's civic identity. Through the preservation of icons and historic locations such as the Space Needle, the Olmsted network of parks and boulevards, and Pioneer Square, the city can continue to celebrate its heritage and maintain its unique sense of place.~~

~~The benefits of historic preservation are not merely aesthetic. Preservation is integral to our economic development planning, and it also enhances our city's identity as a center for tourism, itself an important source of local jobs. Preserving historic buildings can help incubate small businesses, revitalize commercial districts, and generate local jobs. Historic preservation promotes sustainability through the reuse, repair, and upgrading of existing built resources. Historic preservation policies are contained in the Land Use element of this Plan.~~

Council's Amendment

As noted in the Historic Preservation and Cultural Resources section contained in the Land Use element of this Plan, historic and cultural resource preservation recognizes and protects aspects of our shared cultural heritage— buildings, districts, and designed landscapes that link to Seattle's past. Older buildings, sites and objects play a vital role in defining Seattle's sense of place and the character of its neighborhoods.

177 On page 145, add a new policy AC 4.4, as follows

AC 4.4 Encourage the adaptive reuse of historic community structures, such as meeting halls, schools, and religious buildings, for uses that continue their role as neighborhood anchors.

Renumber policies AC 4.4 through AC4.11 as policies AC 4.5 through AC 4.12, accordingly

178 On page 145, amend Policy AC 4.5, as follows

AC 4.5 Encourage partnerships to use ~~using~~ public and institutional spaces, such as parks, community centers, libraries, hospitals, schools, universities, and City-owned places, for arts, musicians, and culture.

179 On page 145, amend Policy AC 4.8, as follows

AC 4.8 Create a toolkit, in partnership with City departments and communities, to assist ~~Share a tool kit of ways communities can make in making~~ their own art, music, and culture, ~~created in partnership with City departments and community interests.~~

Attachment 14. Community Well-Being Element Amendments

Council's Amendment	
109	<p>On page 149, add new policy CW 1.7, as follows</p> <p>***</p> <p><u>CW 1.7 Collaborate with marginalized communities on strategies they identify to reduce and ameliorate displacement and related issues specific to those communities.</u></p> <p>***</p>
110	<p>On page 151, amend policy CW 3.3, as follows</p> <p>***</p> <p>CW 3.3 Collaborate with Public Health—Seattle & King County, private hospitals, and community health clinics to maximize access to health care coverage for preventive care, behavioral health, <u>family planning</u>, and long-term care.</p> <p>***</p>
111	<p>On page 157, amend policy CW 7.5 as follows</p> <p>***</p> <p>CW 7.5 Consider related issues, such as transportation, <u>access to frequent transit</u>, and the need for dependent care, urban planning for health, human services, employment, education, and recreation programs.</p> <p>***</p>
112	<p>On page 157, amend policy CW 7.7, as follows</p> <p>***</p> <p>CW 7.7 Site new human service facilities in or near urban centers and villages, <u>considering access to frequent transit</u>, and use good-neighbor guidelines that consider the needs of consumers and the community.</p> <p>***</p>
184	<p>On page 156, add a new policy CW 6.6</p> <p>***</p> <p><u>CW 6.6 Support community development activities in areas with low access to opportunity and high displacement risk.</u></p> <p>***</p>

Attachment 15. Glossary Amendments

Amend the Glossary to the Plan on pages 184 through 190, by adding the following terms in alphabetical order, as follows

Council's Amendment	
113	Define the term "boulevard network" as "the roadways designated in the early 20th century Olmsted open space plan for the city, that generally include generous landscaping and medians"
114	Define the term "community involvement" as "Outreach (bringing information to communities), engagement (building ongoing relationships with communities) and other actions taken to identify and/or address issues of interest to a community."
115	Define the term "community" as " a group of people sharing a common experience or interest; e.g., residents of a neighborhood, faith-based congregations, business owners along a commercial corridor, members of ethnic and cultural groups, gardeners at a P-Patch, school-based organizations."
116	Define the term "complete corridor" as "two or more parallel roadways that together serve all types of travel – cars, transit, freight, pedestrian and bicycle."
117	Define the term "equal" as "a solution or outcome where every community or community member receives the same level of resources, regardless of their level of need."
118	Define the term "equitable" as "a solution or outcome where resources are allocated according to each community or community member's level of need."
119	Define the term "equity" as "Everyone has fair and unbiased access to the resources they need to meet their fundamental needs and fully participate in the life of their community."
120	Define the term "flex area" or "flex zone" as "the portion of a right-of-way between vehicle travel lanes and the pedestrian area that can accommodate parking, loading, plantings, and street furniture."
121	Define the term "green infrastructure" as "the use of vegetation to absorb, slow and cleanse stormwater"
122	Define the term "Level of Service" as "a standard used to measure the performance of a system, such as the transportation system."
123	Define the term "local access street" as "a non-arterial street that provides direct access to destinations."

Council's Amendment	
124	Define the term "mode-share" as "the percentage of all trips made by a certain method or 'mode' of travel, such as single-occupant vehicles."
125	Define the term "neighborhood" as "a geographically localized district within a city; e.g., Ballard, South Park, Columbia City, Greenwood."
126	Define the term "on-street parking pricing" as "the amount of money charged to park a vehicle along a street; in some locations in the city, the amount may vary by time of day or day of the week"
127	Define the term "regional transportation pricing" as "coordinated effort among governments in the region to set prices for parking, roadways or transit"
128	Define the term "roadway pricing strategies" as "fees charged for the use of a road, including tolls, or time- and distance-based charges to help fund improvements and to encourage efficient use of the roads"
129	Define the term "shared use" as "in the right-of-way, this refers to two or more uses that occur in the same space at either the same or different time, such a curb lane that is used for parking most of the day, but for vehicle travel during the peak commute time."
130	Define the term "transportation demand management" as "strategies to reduce the number of single-occupant car trips, such as by providing more transit, or improving pedestrian and bicycle facilities."
131	Define the term "underrepresented population" as "Communities and groups provided with insufficient or inadequate representation relative to their proportion of the total population."
132	Define the term "underserved population" as "Communities and groups provided with insufficient or inadequate resources or services relative to their needs and/or proportion of the total population."
133	Define the term "vibrant pedestrian environment" as "an area where transit, shops, restaurants, entertainment and other uses attract a variety of people traveling on foot."
134	Define the term "vision zero" as "a program to improve roadway safety with the goal of having no fatalities and serious injuries"

Council's Amendment	
135	Define the term "walking distance" as: "generally assumed that people are willing to walk up to ½ mile to frequent, reliable transit and up to ¼ mile to other types of transit."
186	Define the term "neighborhood plan" as "the goals and policies adopted in the Comprehensive Plan, consistent with the Growth Management Act, that detail how the vision, goals and policies of the elements of the Comprehensive Plan apply to a specific geographic area."
	Define the term "community plan" as "a plan developed in collaboration with a community around a shared vision that includes a set of strategies to meet community and city goals."

Attachment 16. Amendments to Neighborhood Plans

Council's Amendment	
Central Area Neighborhood Plan	
136	<p>On page 220, amend Policy CA-P34, as follows</p> <p>***</p> <p>CA-P34 Provide development incentives <u>or requirements to multi-family housing developers for the provision of affordable housing units within market rate housing projects.</u></p> <p>***</p>
Downtown Neighborhood Plan	
137	<p>On page 245, amend Goal DT G10, as follows</p> <p>***</p> <p>housing goal</p> <p>DT-G10 Seek to significantly expand housing opportunities in downtown Seattle for people of all income levels with the objectives of:</p> <ol style="list-style-type: none">1. accommodating household growth;2. at a minimum, maintaining the <u>preserving</u> existing number of occupied low-income units; and3. developing a significant supply of affordable housing opportunities in balance with the market resulting from the growth in downtown employment. <p>Allow housing in all areas of the Downtown Urban Center except over water and in industrial areas, where residential use conflicts with the primary function of these areas. Target public resources, <u>requirements imposed on new development, and private development incentives, such as density regulations and development standards that encourage housing,</u> to promote the amount and type of housing development necessary to achieve downtown neighborhood housing goals. Address, in part, the impact of high-density commercial development on the downtown housing supply by allowing increased development density through voluntary agreements to produce and/or preserve housing through cash contributions, floor area bonuses or the transfer of development rights <u>the need for affordable housing through a range of strategies including both incentive-based and non-incentive-based strategies.</u></p> <p>***</p>
138	<p>On pages 252 and 253, amend Policies DT-LUP8 through DT LUP10, as follows</p>

Council's Amendment

DT-LUP8 Generally limit the density of uses that generate employment through a floor area ratio (FAR), and the density of residential uses generally through the combination of height and bulk regulations.

~~Apply a base and maximum limit on permitted density, as expressed by a floor area ratio (FAR), in areas able to accommodate more intensive development provided that impacts associated with the added density are addressed. Reflect in the base FAR limit the density of employment that the City will accommodate without additional mitigation measures.~~

~~Reflect in the maximum FAR limit the additional density above the base that may be allowed through bonuses or TDR, or both, as appropriate for the zone or district, if appropriate measures are taken to mitigate specified impacts. Consider density incentives to encourage development on smaller lots to add diversity to the scale of development in high density office core areas.~~

~~Floor Area Limit Exemptions. Allow exemptions from floor area ratio FAR limits to recognize the lower impacts of certain uses and encourage certain uses that generate minimal peak period commute trips, support pedestrian activity, and transit use, and contribute to the overall diversity of activity downtown, increasing its attractiveness as a place to live, work, and recreate.~~

DT-LUP9 Allow additional floor area ~~above the base densities~~, and consider adding greater height where appropriate, up to maximum limits, in specified downtown areas where it is desirable to accommodate growth, ~~through bonuses and transfer of development rights. In determining conditions for bonus floor area,~~ Consider measures to mitigate impacts of higher density development on the downtown environment, including such resources such as affordable housing, public open space, child care, human services, and pedestrian circulation.

Allow transfer of development potential from one site to another in certain circumstances, consistent with policy ~~LU 11~~**DT-LUP11**. When transferable, development potential is referred to for convenience as "transferable development rights," or "TDRs," but such terms do not mean that there is any legal right vested in the owner of TDRs to use or transfer them. The conditions and limitations on the transfer or use of TDRs may be modified from time to time as the City may find appropriate to implement the policies of the Comprehensive Plan in light of experience and changing conditions.

Allow transfer of development rights from eligible sending sites to project sites in combination with the use of bonuses. Consider allowing TDRs to be used for all floor area above the base FAR under some conditions.

Council's Amendment

Recognize different impacts associated with density increases achieved through different options for increasing floor area.

~~Priorities for granting floor area increases~~

Consider allowing greater use of incentives for open space and other neighborhood amenities in mixed use residential areas where floor area incentive programs apply to respond to the greater impact of growth on these public resources in high density residential environments.

~~DT-LUP10 Consider allowing~~ Allow voluntary agreements to mitigate the impact of development-earn floor area increases above the base density in certain downtown zones, and also consider adopting non-mitigation-based strategies for the provision of low-income housing. Consider allowing such options as:

1. providing low-income housing,
2. providing child care facilities,
3. making payments to the City to fund such facilities,
4. providing certain amenity features, combined with the use of options 1 and 2 or with the use of TDRs, or both.

- Consider allowing ~~bonus~~ floor area for certain amenity features, such as open space, on or near the development site that directly benefit both the public and the project by serving the increased employment population and improving conditions in the immediate environment to support the increased density allowed.

~~Some facilities and amenity features that may be eligible for bonuses are identified under the following Policies:~~

- ~~1. Policy HO 3: Housing Bonus Program~~
- ~~2. Policy OS 5: Open Space Bonus Amenity Features~~
- ~~3. Policy HS 1: Child Care Bonus~~

- If ~~bonus~~ cash contributions are provided under a mitigation rationale, they should be used to address impacts associated with downtown development, such as impacts on housing resources and child care.

~~Amount of B~~ benefits for Floor Area Increases. The nature and quantity of housing and child care facilities or contributions for such facilities under voluntary agreements, in relation to the ~~additional~~ floor area allowed, should generally reflect a portion of what is necessary to mitigate the impacts of increased development and the cost to provide these facilities. Facilities provided ~~for bonuses~~ are not expected to fully mitigate such impacts. Additional types of facilities or amenity features may be added to address future needs, and existing

Council's Amendment

types of facilities or features may be no longer be eligible for bonuses, based on changing assessments of impacts, needs, capacity, and public priorities.

Special Criteria. Because of their complexity and the need to adapt them to special circumstances, subject certain bonus features to special criteria and review by the Director of DPD. Include among bonus features subject to special criteria urban plazas, transit station access, and public atriums.

139 On pages 261-262, amend Policies DT-HP3 through DT-HP5, as follows

DT-HP3 Address the demand for housing for low-income households downtown, including that generated by downtown growth that is not being met by the private market, and help offset the pressure of downtown growth on existing affordable housing resources, through provisions to encourage or require the development of affordable housing, especially for households with incomes between 0 percent and 80 percent of the median income for the region. To this end, within downtown office, retail, mixed use commercial, and mixed use residential areas ~~with established base and maximum density limits, generally allow bonus floor area,~~ consider, among other strategies, conditioning floor area upon a voluntary agreement for the provision of lower-income housing or a payment to a fund for that purpose. To further downtown housing goals, limit housing developed through ~~the bonus such a~~ program to areas permitting housing within the boundaries of the Downtown Urban Center, except that additional areas may be included if such an expansion of the program would be consistent with the goals of both the Downtown Urban Center Plan and the adopted policies of other relevant neighborhood plans. Density bonuses shall not be granted for any housing developed within the Pike Market Mixed zone, where other mechanisms are available to achieve the housing objectives of this land use district.

Require that housing provided ~~for density bonuses~~ serve a range of lower-income households, particularly those with incomes below 80 percent of median income. Where housing is provided under a mitigation rationale, it should be based on the estimated additional needs resulting from new commercial or residential development. ~~Take into account, in determining the amount of housing to be provided, the value of the increased development potential in relation to the cost to the developer, and the extent to which use of bonus floor area is desirable in light of the City's planning goals. Review bonus provisions for housing periodically to consider changes in impacts on housing need, land prices, housing production costs, progress towards planning goals, and other factors.~~

DT-HP4 Promote the integration of downtown residents of different income levels by encouraging new development that includes units affordable to households with a

Council's Amendment

range of incomes, including low-income residents. Seek through the administration of funds available for new low-income housing to encourage projects with units affordable to households with a range of incomes, and consider additional incentives or requirements for promoting this type of development.

DT-HP5 Pursue the following strategies for maintaining existing downtown housing resources, including but not limited to the following:

~~Housing Transfer of Development Rights (TDR). Allow the transfer of unused development rights from structures providing at least a minimum amount of low-income housing, which may be mixed with low-moderate income housing and/or other uses, to sites located elsewhere in the downtown to provide an incentive for maintaining this housing resource. Condition the use of this mechanism to address issues such as the use of subsidies or tax benefits that may reduce or eliminate the need for preservation incentives, required rehabilitation and compliance with housing and building codes, and the length of time the housing is to be maintained at specified affordability levels.~~

~~Preservation of Project-Based Section 8 Housing. Seek to promote preservation of federally-assisted housing units in downtown Seattle that are at risk of conversion to market rate rentals or other uses.~~

~~Minimum Housing Maintenance. To prevent the deterioration and abandonment of sound downtown housing units, consider and evaluate alternatives for a minimum maintenance program including incentives to discourage the neglect of sound housing.~~

~~Publicly Supported Housing Programs. Aggressively seek funds and target programs as appropriate to rehabilitate existing structures, construct new low and low-moderate income units and provide rent subsidies. Review annually public housing resources and the findings of the housing monitoring program and programs targeted to the most cost-effective actions to achieve goals for the number of low-income units to be provided by the year 2014.~~

Fremont

140 On page 295, amend Policy F-P14, as follows

housing policies

~~F-P14 Make use of existing tools in striving to assure that the impacts of new growth are mitigated~~ to address affordable housing needs.

Council's Amendment	
North Beacon Hill	
141	<p>On pages 326-327, amend Policies NBH-P3 and NBH-P4, as follows</p> <p>***</p> <p>NBH-P3 Encourage a mix of unit prices and sizes through active-use of incentives, <u>requirements on development</u>, direct City funding, and/or surplus property programs.</p> <p>NBH-P4 Encourage affordable, family-sized homes through incentives, <u>requirements on development</u>, direct City funding, and/or surplus property programs. In particular, strive to preserve, or when needed, replace affordable family-sized apartments.</p> <p>***</p>
North Rainier	
142	<p>On page 340, amend Policy NR-P13, as follows</p> <p>***</p> <p>NR-P13 Encourage a mix of home prices and sizes through active-use of incentives, <u>requirements on development</u>, and/or funding.</p> <p>***</p>
Rainier Beach	
143	<p>On page 366, amend Policy RB-P12, as follows</p> <p>***</p> <p>RB-P12 Seek to preserve the economic, racial/ethnic, and cultural diversity of Rainier Beach's population by providing affordable housing, including home-ownership opportunities, through capital funding, and incentive programs (e.g. Multifamily Tax Exemption), and/or land use/zoning use/zoning tools, including, where appropriate, rezones <u>and other measures encouraging or requiring provision of affordable housing by new development</u>.</p> <p>***</p> <p>RB-P16 Encourage affordable family-sized units through incentives, <u>requirements on development</u>, direct City funding, and/or reuse of publicly owned property.</p> <p>***</p>
South Lake Union	

Council's Amendment

144 On page 382, amend Policy SLU-P33, as follows

SLU-P33 Provide incentives ~~to encourage or requirements~~ for provision of housing for people across a range of incomes in a variety of housing types, particularly in mixed-income buildings.

Attachment 17. Amendments to the Appendices

Council's Amendment	
145	On page 405-408, add housing and jobs development capacity figures for each urban center and village to Growth Strategy Appendix Figures A-1 and A2. The numbers can be found in Table 2-2, page 2-15 from the "Final Environment Impact Statement for the Seattle Comprehensive Plan Update."
146	On pages 405-406, add numerical growth estimates to Growth Strategy Appendix Figure A-1, derived by: For Urban Centers: adding the Estimated Urban Center Growth in Housing Units from Growth Strategy Figure 2 on page 29 of the Plan to the 2015 Year-End Total Housing Units from Growth Strategy Appendix Figure A-1 on pages 405 and 406 For Hub Villages and Residential Villages: multiplying the Expected Housing Growth Rate from Growth Strategy Figure 3 on page 30 by the 2015 Year-End Total Housing Units from Growth Strategy Appendix Figure A-1 on pages 405 and 406; reduce any housing estimates to 80% of the development capacity figures described above, if the numerical growth estimate is equal to more than 80% of the development capacity figure for that village
147	On pages 407-408, update Growth Strategy Appendix Figure A-2, by replacing 2014 Covered Employment figures with 2015 Covered Employment numbers and add numerical growth estimates, derived by: For Urban Centers and Manufacturing/Industrial Centers: adding the Estimated Urban Center Growth in Jobs from Growth Strategy Figure 2 on page 29 of the Plan to the 2015 figure from Growth Strategy Appendix Figure A-1 on page 405 and 406 For Hub Villages: multiplying the Expected Job Growth Rate from Growth Strategy Figure 3 on page 30 by the 2015 figure from Growth Strategy Appendix Figure A-2 on pages 407 and 408; reduce any housing estimates to 80% of the development capacity figures described above, if the numerical growth estimate is equal to more than 80% of the development capacity figure for that village
148	On pages 413 and 414, remove the columns showing total population in 2010 and the Population/Acre from Land Use Appendix Figure A-3 titled Jobs per Acre by Urban Center and Urban Village.
149	On page 439, edit the title of Transportation Appendix Figure A-11 as follows: SOV Mode Share 2015 Performance and 2035 SOV Mode Share Targets by City Geographic Sector And, replace Figure A-11 with the amended version of Figure A-11 shown below:

Council's Amendment

Amended Figure A-11

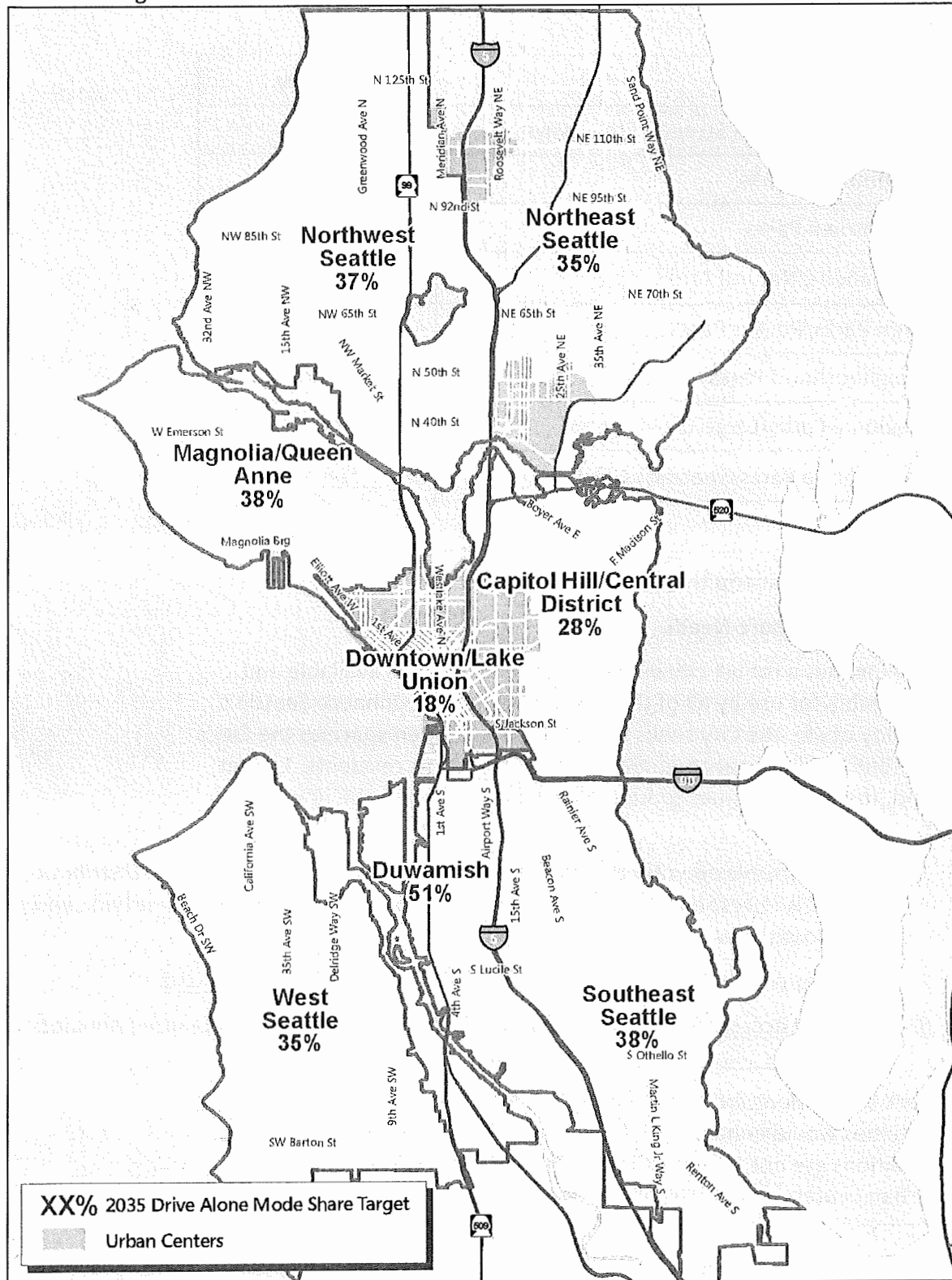

Council's Amendment

150 On pages 525 and 526, update Capital Facilities Appendix Figure A-5, Table of Parks by Type, as follows

Park Type	Size of Facility
Boulevards/Green Streets/Greenways	340 <u>348</u> acres
Community Parks	606 <u>699</u> acres
Downtown Parks	23 acres
Greenbelts/Natural Areas	1,285 <u>1,492</u> acres
Mini Parks/Pocket Parks	41 <u>58</u> acres
Neighborhood Parks	717 <u>568</u> acres
Regional Parks/Large Urban Parks	2,716 <u>1,446</u> acres
Special-Use Parks/Specialty Gardens	384 <u>1,366</u> acres

151 On page 529, amend the Plan, as follows

Forecast of Future Needs

The City has a robust citywide park system, which is available and accessible for use by all of the City's residents. To enhance Seattle's quality of life, the City seeks to add parks and open space to the City's system as additional amenities for all of the City's residents. To that end, the City continues to fund park acquisition with the primary goals of:

1. *pursuing usable open space acquisition in areas where the acreage and distribution of parks is lowest on a per capita basis. These are mostly found within urban centers and villages; ~~and~~*
2. *acquiring properties that can complete or expand existing parks; and*
3. *providing access to open space and recreation activities for marginalized populations and in areas that have been traditionally underserved.*

Park acquisitions are opportunity-driven. Additions to the park facilities would enhance the City's quality of life. However, such additions are not necessary to accommodate new households in urban centers, urban villages, or citywide.

Council's Amendment

Planned investments in the maintenance of existing facilities are provided in the CIP and updated annually according to asset management priorities and available funds.

152 On page 551, Amend the list of Plan as follows

Fire

- South Lake Union Fire Station development
- Freshwater Marine Station relocation
- Fire Administration Building relocation
- Fire Marshal's Office relocation
- Warehouse Space replacement
- Joint Training Facilities expansion

180 On page 552, amend the list of Potential Future Discretionary Projects, under "General Facilities" as follows

- Material storage facilities
- Municipal Broadband
