

Seattle Department of Transportation

PARKLET HANDBOOK



CONTENTS

	SEATTLE'S PARKLET HANDBOOK		
5	Why Build a Parklet?	39	TECHNICAL DEVELOPMENT
5	Parklet Origins	40	Construction Documents
6	Program Goals & Objectives	40	Construction Use Permit
			Liability Insurance
8	PARKLET PROCESS		
	PRE-PLANNING		BUILDING YOUR PARKLET
11	General Considerations & Guidelines	42	Permit Issuance & Fees
14	Costs	42	Installing Your Parklet
16	Funding	43	Off-Site Construction
		43	Parklet Safety Elements
	APPLICATION	44	Parklet Signs
18	Application Process	44	On-Street Bicycle Parking
21	Selection Criteria	45	Celebration!!
	DESIGN DEVELOPMENT		POST-INSTALLATION
23	Assembling a Team	47	Maintenance
24	Draft Concept Design	47	Permit Renewal
26	Concept Design Review	47	Parklet Evaluation
26	Public Space Permitting	48	Making Changes to Your Parklet
26	Public Notice	48	Change of Ownership
27	Parklet Design Guidelines	48	Parklet Removal
			SUPPLEMENTS
			Forms & Samples Supplement
			Streatery Supplement



SEATTLE'S PARKLET HANDBOOK

This handbook tells you everything you need to know about designing, permitting, and building a parklet in Seattle. It will help you figure out what's required to make your parklet dreams a reality. Whether you're a business owner or a member of a community group, a designer or a contractor, you'll find information about parklet permitting and review processes, siting and design guidelines, and parklet host responsibilities in the following chapters.

There's also a supplement to this handbook that introduces our Streatery Pilot Program. While a streatery is a lot like a parklet—it turns a few on-street parking spots into space for people—it has some important differences. Be sure to read the supplement to decide whether a parklet or a streatery is best for you and your neighborhood.

We're glad you're thinking about a parklet or streatery, and we look forward to working with you and seeing your creative ideas take shape. If you have additional questions that we haven't answered, please contact us at parklets@seattle.gov or (206) 684-5267 or visit www.seattle.gov/transportation/parklets.htm.

WHY BUILD A PARKLET?

Parklets convert a few on-street parking spaces into public open space and are a cost-effective way to activate streets, create more vibrant neighborhoods, and promote economic vitality. Parklets are privately funded and maintained by a hosting organization or business, but serve as public space that is accessible to all. Although parklets are not considered permanent, they are approved under a Public Space Permit that can be renewed from year to year if the parklet serves the neighborhood well.

Parklet programs have been created in cities around the world as a way to support community-driven projects that allow people to use streets differently. These programs support creative spaces that add “people places” to the public right of way. Parklets also encourage walking and biking and create more attractive and inviting commercial districts.

Along with community groups, Seattle businesses are enthusiastic about adding public space to their blocks. Parklets can increase foot traffic and add seating space near local businesses, while still maintaining on-street parking nearby.

PARKLET ORIGINS

The term “parklet” originated in San Francisco to describe the conversion of a parking space into a small public park. A San Francisco design studio created the first parklet in San Francisco in 2005—it was open for just 2 hours and is credited with launching [PARK\(ing\) Day](#). PARK(ing) Day is now an annual worldwide event on the third Friday of September during which anyone can create a one-day parklet. The success of PARK(ing) Day led San Francisco planners to consider parklets that would last an entire summer or even longer, and the City adopted a formal program in 2009.

Cities around the world, including Los Angeles, Philadelphia, Chicago, London, São Paulo, and Vancouver have launched individual parklets and full-fledged parklet programs, with each city putting its own spin on the concept. Los Angeles has introduced exercise equipment in parklets, which they call “active parklets.” San Francisco has built “mobile parklets” that can move from block to block and has also allowed parklet corridors that stretch for entire blocks. Other cities, like Montreal and Portland, have parklets that serve as extended sidewalk cafés, allowing restaurants and bars to provide table service in the parklets, much like Seattle’s streateries.

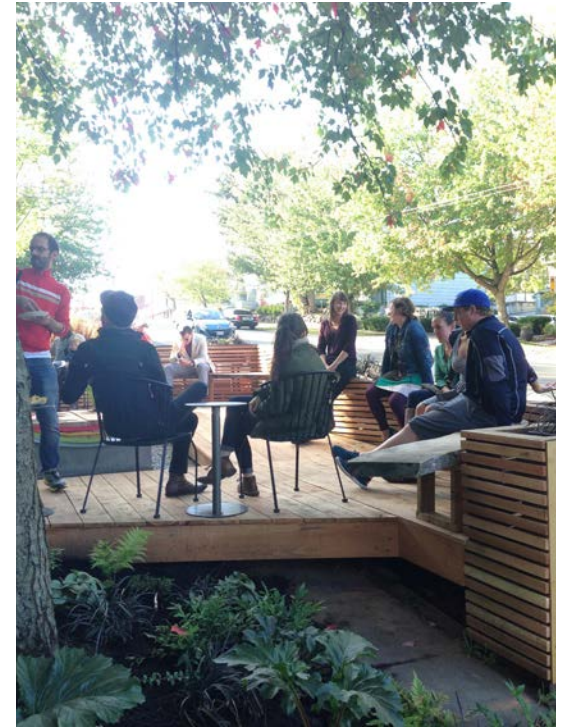

DISCLAIMER

All parklet requirements, review processes and fees, application evaluation criteria, and host responsibilities listed in this handbook are subject to change. SDOT reserves the right to amend any aspect of these guidelines at any time. Program applicants who do not agree with the amended terms may withdraw their applications.

PROGRAM GOALS AND OBJECTIVES

SEATTLE DEPARTMENT OF TRANSPORTATION

MISSION

Delivering a first-rate transportation system for Seattle

VISION

A vibrant Seattle with connected people, places, and products

Safe City

Eliminate serious and fatal crashes in Seattle

Interconnected City

Provide the most effective choices in transportation of any North American city

Vibrant City

Improve Seattle's health, prosperity, and happiness

Affordable City

Provide high-quality, low-cost travel options for everyone

Innovative City

Think big and provide great service



PUBLIC SPACE MANAGEMENT PROGRAM

The public right of way, which includes streets, sidewalks, and street trees, makes up 27% of Seattle’s land area, providing many opportunities to expand and activate public spaces. The Public Space Management Program supports creative improvements in our streets and sidewalks and makes it easier for community groups and businesses to enliven the city’s public spaces.

The program is driven by 4 goals that help us promote and regulate a vibrant, safe, accessible, and attractive shared right of way:

ENCOURAGE: Promote the activation of public space

IMPLEMENT: Ensure that opportunities to activate the right of way are not missed due to perceived obstacles or implementation hurdles

INNOVATE: Identify opportunities for activation

REGULATE: Manage our public spaces in a transparent and predictable way

PARKLET PROGRAM BACKGROUND

The Public Space Management Program began exploring parklets with its Pilot Parklet Program, launched in summer 2013. The pilot started with 3 Seattle organizations. Montana Bar on Capitol Hill was the first business to complete its parklet, followed by the Chinatown/International District Business Improvement Area. City Hostel in Belltown is currently planning for the construction of its parklet. We worked with each of these applicants to develop a parklet review process.

To evaluate parklets in more diverse conditions, we extended the pilot in 2014 and added 12 more parklet hosts to the program. The Pilot Parklet Program was successful, with positive responses citywide from businesses and community members. The Parklet Program was then made permanent in 2015 and we continue to work with businesses and community groups that want to provide active community amenities in the public right of way.

PROGRAM OBJECTIVES

Seattle’s Parklet Program is guided by the following objectives:

- 1) Activate Seattle’s streets through unique, community-driven projects
- 2) Support local businesses and promote economic vitality in commercial districts
- 3) Supply new spaces for community interaction
- 4) Encourage walking, biking, and the use of transit
- 5) Provide safe, comfortable, and useful public spaces within the public right of way



PARKLET PROCESS

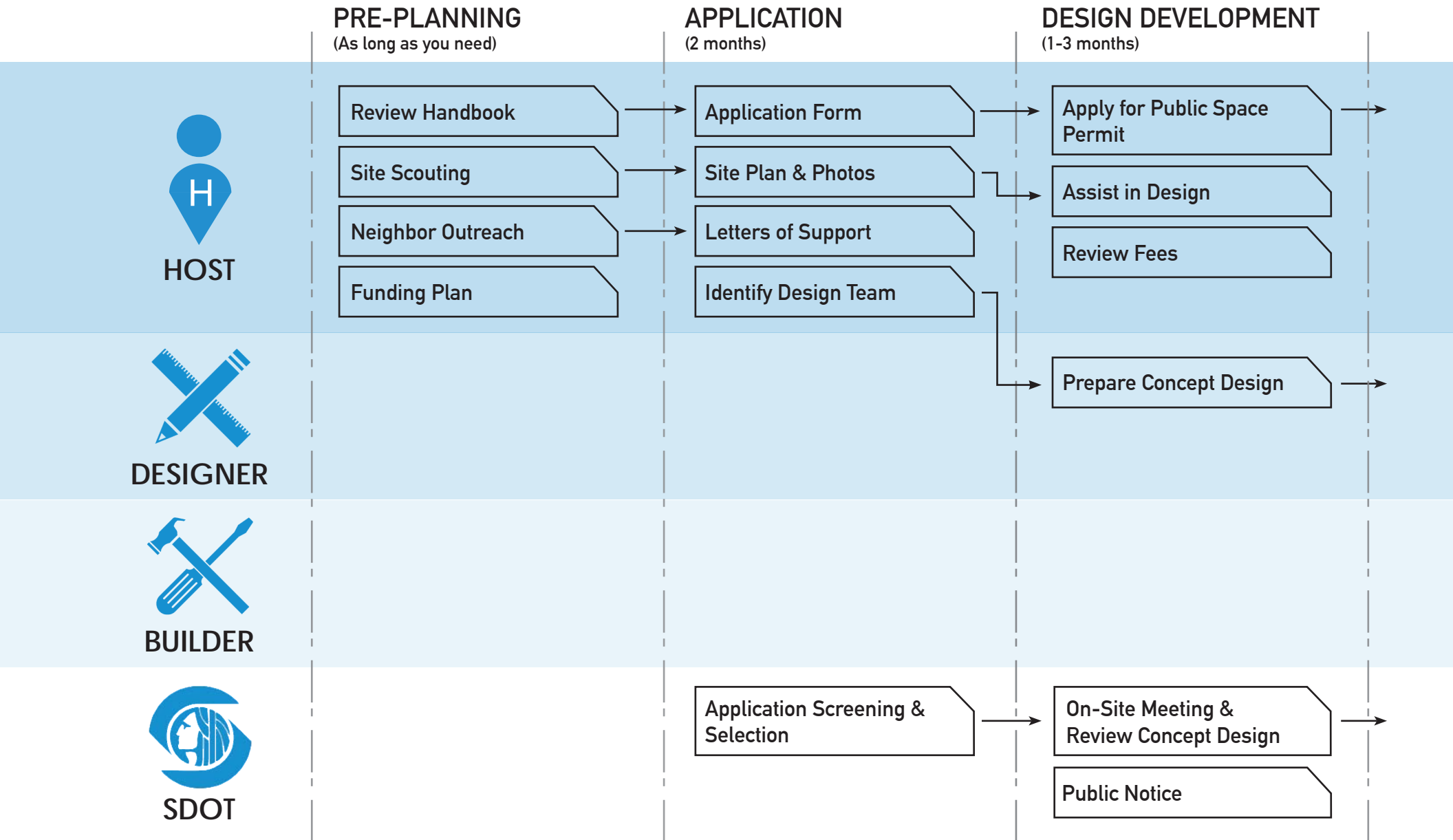

*Timelines are rough estimates. For example, some parklets may advance quickly through design but take longer to install. The more complete your proposals and documents, the faster you'll be able to move through the parklet process. The entire parklet process from initial application to parklet opening will take about 4 to 12 months.

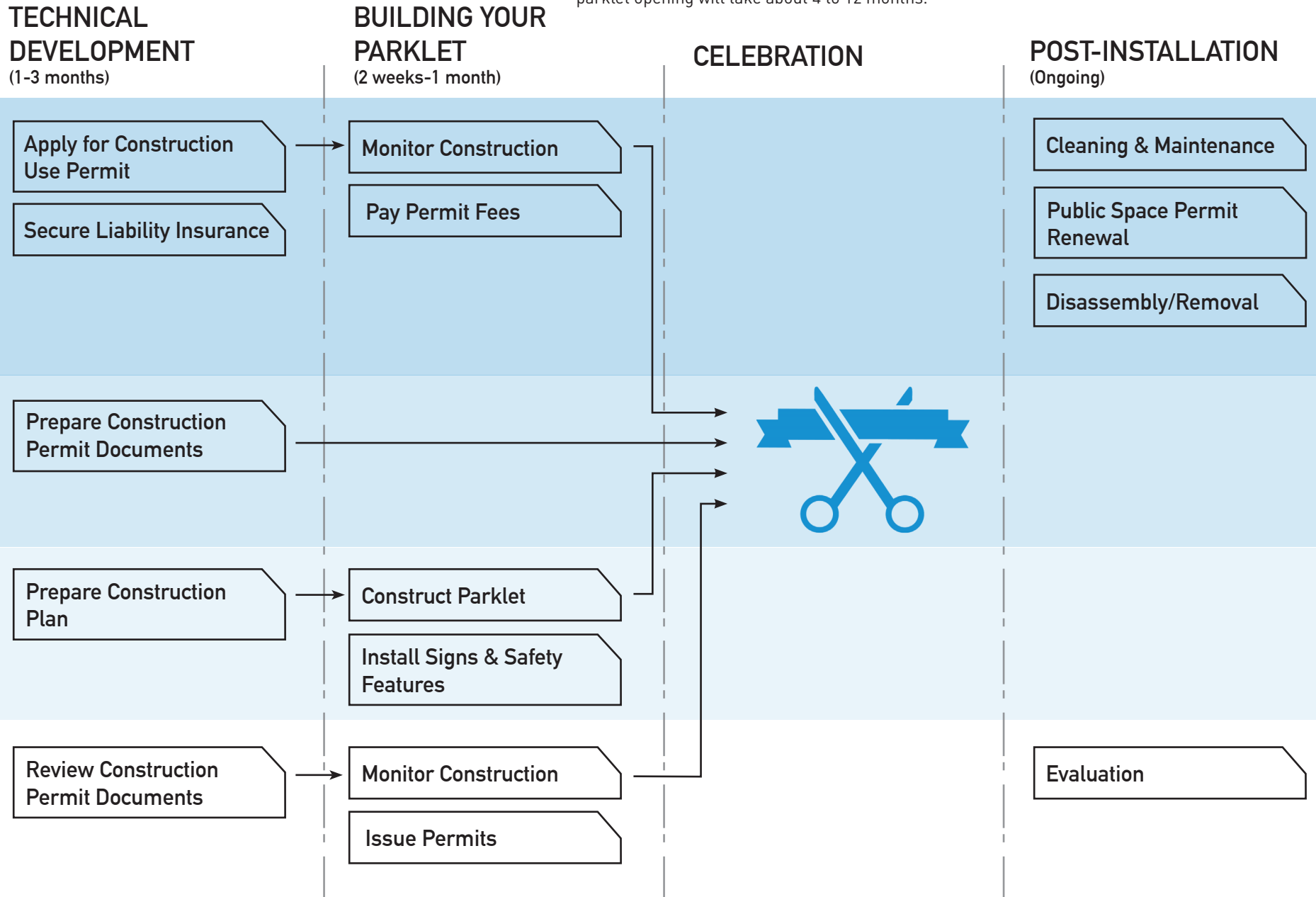



PRE-PLANNING

Review Handbook

Site Scouting

Neighbor Outreach

Funding Plan

PRE-PLANNING

GENERAL CONSIDERATIONS & GUIDELINES

The first step in creating a successful parklet is making sure that it has a good home. This means finding a location where a parklet fits into the neighborhood and where a community will support and use the parklet throughout the year.

Designing a parklet will take time and effort. Therefore, you need to think about the following elements when selecting your parklet location. Parklets can work well on many types of streets in Seattle, but some streets are better than others. In short, you're probably in good shape if you don't build on a steep hill, don't choose a highway, and don't block anything that looks important: driveways, utilities, public transit, or fire hydrants.

Once your initial application has been approved, we'll schedule an on-site meeting with you to look at the specific opportunities and constraints at your site. However, you'll first need to choose a location that will support the parklet's success without creating substantial impacts for the street.



NEIGHBORHOOD CONTEXT

Parklets work best in places where people frequently walk. In areas where sidewalks are narrow, they provide supplemental space for pedestrians. You want people to notice your parklet and use it, so think about the type of neighborhood and block that will support the parklet. Think about what people will be doing near your parklet, how many people will be walking on the street, and where they might like to stop for a while.



LOCATION ON THE BLOCK

Safety is our most important consideration, so all parklet locations must be chosen to keep sightlines clear for people on streets and sidewalks. Corner locations can be great for visibility of the parklet; however, the closer you are to a corner, the more complicated siting a parklet becomes due to pedestrian and driver visibility. A parklet's location along a block will impact how tall it can be and the design features it can include.



STREET SLOPE

You may have noticed that Seattle is a hilly city. In general, it's much easier to build a parklet on a flat site, as the base of a parklet can have a maximum slope of 5% to allow for access of all people. So, while it is okay to build a parklet on a street that is steeper than 5%, it will require additional engineering work, which can be costly.



CURB USE

Since parklets use space along the curb, you need to think about who else and what else uses the space that you want. For example, you can't put a parklet at a fire hydrant or bus stop. You should also try to avoid load, taxi zones, disabled parking, and other designated zones. While it's possible to work with us and with your neighbors to relocate these zones, they are critical for deliveries and drop-offs for nearby businesses and residents. Also, if there's paid parking on the block, place the parklet where it will leave 4 parking spaces in a row. That will keep remaining spaces grouped close to a parking pay station.



UTILITIES

Streets in Seattle move more than people and cars. Under the street, you'll find water, sewer, and electric pipes and vaults. City workers and private utility owners need access to these utilities, so parklets can't block utility covers or equipment. Make note of any utility covers or boxes that might conflict with where you'd like to build your parklet. You can also [contact us](#) if you have any questions about where utilities are located at your parklet site. You should be aware that if utility providers need to excavate the street or maintain the overhead infrastructure around your parklet, your parklet may need to be temporarily removed.



STREET TREES & PLANTING STRIPS

Putting a parklet near trees and other plantings can be a great way to shade your parklet in the summer and add a little greenery year-round. But it's important to remember that plants need space to grow, and street trees are carefully managed by SDOT. You should avoid locations that would force people to walk through a tree pit or landscaping to get to the parklet. When locating your parklet near trees or overhead utilities, you should also consider how droppings from trees and animals might impact your parklet users.



PROXIMITY TO OTHER STREET USES

Like you, lots of people use the right of way to create places to gather, play, and eat. Check around for other parklets, sidewalk cafés, outdoor vending, bike share stations, and other uses of the street that would be good neighbors for your parklet. You may also want to look for areas that don't have much activity; your parklet could play a big role in fixing that.



NEIGHBORHOOD SUPPORT

Finding a location where your parklet will be embraced and enjoyed by the community is as important as any of the physical elements of your site. The more support your parklet has from nearby neighbors, the more support you can expect to help design, fund, take care of, and use it. While you don't need the permission of all of your neighbors, you do need to contact them and let them know what you want to build.



COORDINATION WITH CITY PROJECTS

The City of Seattle has a lot of projects planned—not to mention all of the private development underway—which may require replacing or reconfiguring the street. If a City project is in the works for the street on which you want a parklet, you may have to remove the parklet so we can do our work. You should look at the lists of upcoming projects in the City’s [freight](#), [transit](#), [bicycle](#), and [pedestrian](#) master plans and our [Capital Projects Dashboard](#) so you know where we’ll be working in the near future.

COSTS

Parklets are funded entirely by the parklet host, and the total cost of installing a parklet depends on the size and design of your parklet. Parklet costs can range from \$15,000 to \$50,000 or more, including all design, review and permitting fees, materials, and construction. Keep in mind that smaller, simpler parklets on flatter sites are much less expensive to design and construct than larger, intricately-designed parklets on sloped streets.

Check out the parklets on the following page to get an idea of how much you should budget for the installation of your parklet. In addition to the initial capital costs of installing a parklet, hosts also need to budget for ongoing expenses such as parklet maintenance and removal, if needed. While the costs of building a parklet may seem high, there are various funding strategies that you can consider to help support your project (see page 16).

PERMITTING FEES

Fee Purpose	Fee*	Payment Time	Process Phase
Public Space Permit Review Fee	\$588	Submittal of Public Space Permit Application	Design Development
Public Space Permit Issuance Fee	\$146	Issuance of Public Space Permit	Building Your Parklet
Traffic Control Plan Review Fee (if applicable)	\$98	Submittal of Construction Use Permit Application	Technical Development
Inspection Deposit	\$196	Issuance of Construction Use Permit	Building Your Parklet
Construction Use Permit Issuance Fee	\$305	Issuance of Construction Use Permit	Building Your Parklet
Public Space Permit Renewal Fee	\$140	Annually	Post-Installation
TOTAL	~\$1,300		

* Fees are subject to change

PILOT PARKLET COST ESTIMATES

MONTANA BAR

23' long, 8% slope



Design	\$4,000
Materials/ Construction	\$19,000
Permits	\$1,000
TOTAL	\$24,000

MOLLY MOON'S

20' long, 5% slope

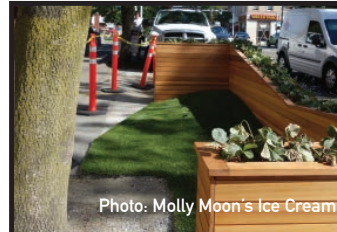

Design	\$5,000
Materials/ Construction	\$31,000
Permits	\$1,000
TOTAL	\$37,000

CHROMER BUILDING

116' long, 4% slope



Design	donated
Materials/ Construction	\$90,000
Permits	\$1,000
TOTAL	\$91,000

Less Costly



More Costly

OASIS TEA ZONE

24' long, 1% slope



Design	donated
Materials/ Construction	\$17,000
Permits	\$1,000
TOTAL	\$18,000

CORTONA CAFE

27' long, 8% slope



Design	\$3,600*
Materials/ Construction	\$28,000*
Permits	\$1,000
Events	\$1,900
TOTAL	\$34,500

*Does not include donated services

FUNDING

In addition to personal and business investment, you may be able to get some services or materials donated to reduce costs—for example, a design consultant or college design student might be willing to work pro bono for the chance to be involved in a parklet project. We can help to connect you with these opportunities and even have a list of design firms on our [website](#) that are interested in providing free or reduced-cost work for applicants.

You might also consider applying for a grant through the [Department of Neighborhoods](#) to cover some of your costs. Online crowdfunding tools, such as [Kickstarter](#) or [Fundly](#), are also an effective way to raise money for parklet projects. Local organizations, like the [Seattle Parks Foundation](#) and local business districts, might also offer grants to support parklet projects. As you talk with your neighbors about your parklet proposal, you may want to ask them to contribute so that they can play a role in the parklet's development.

Also remember that there are ongoing costs associated with parklet upkeep. You'll be responsible for parklet maintenance costs as well as annual permit renewal fees and costs to keep your liability insurance policy current. Make sure that you'll have the financial resources and staff or volunteers available to keep your parklet in good shape throughout the year.

CORTONA CAFE: FUNDRAISING EXAMPLE

While some businesses are able to cover the costs of a parklet on their own, most of the time it takes more than one source of funding to make a project like this a success. One great way to cover parklet costs is to crowd fund! Cortona Cafe in the Central District raised more than \$10,000 through an online fundraising site. They supplemented this with community fundraising events, like pop-up dinners with local chefs and art auctions. They also received a Small & Simple grant from the Department of Neighborhoods, which they matched with community time and other donations.





APPLICATION

Application Form

Site Plan & Photos

Letters of Support

Application Review

APPLICATION

APPLICATION PROCESS

Applications to join the Parklet Program are accepted on a rolling basis and are easy to complete. We require just a few pieces of information (detailed below) to determine whether your proposed parklet site is feasible and to learn about why you want to build a parklet. You may apply for multiple locations, but note that each parklet will be evaluated based on its individual merits.

Application materials may be submitted in person on the 23rd floor of the Seattle Municipal Tower (700 5th Ave) or electronically to parklets@seattle.gov before the deadline. The following materials are required for a complete application:



PARKLET APPLICATION FORM

The parklet application form asks for detailed information about the proposed location of your parklet and an explanation of your interest in building a parklet.

Use this form to list the number and type of parking spaces that you want to use for the parklet, as well as the addresses of the properties next to the proposed parklet. We also ask for a 2 paragraph description of your parklet to help reviewers understand what you're planning for the space.

DOCUMENTATION OF COMMUNITY SUPPORT

Successful parklet applicants are supported by their local communities. To demonstrate this support, you must submit at least 3 letters from businesses, residents, community groups, or property owners in the neighborhood. At least one letter must come from a business or resident located on the same block as the proposed parklet.

The letters don't need to be long, but they should explain the local community's interest in a parklet and support for your application. Additionally, you must provide us with a copy of a letter or email that shows you have contacted the local business or community association in your neighborhood (if applicable) to notify them of your desire to construct a parklet.

Reaching out to other businesses and residents in the neighborhood will make your application more competitive. We strongly recommend collecting signatures on a petition or support log to show widespread community backing for your parklet proposal and to generate excitement among your neighbors (samples are provided in the Supplements).

SITE PLAN

To help us understand how your parklet would fit within the street, you must submit a site plan of the proposed location. The site plan does not need to be drawn by a design professional—it can be a simple hand- or computer-drawn graphic that shows the exact location of the parklet, the area around the parklet, the proposed layout and dimensions, and where parklet amenities (e.g., seating and landscape features) would be placed.

At this stage, we’re primarily trying to determine if your selected site is appropriate for a parklet and how the parklet would integrate into the neighborhood context.

Your site plan must include the following information:

- 1) Location of existing street fixtures (e.g., utility poles and vaults, parking pay stations, bus shelters, sign posts, tree pits) and their distance from the nearest edge of the proposed parklet
- 2) Width of the adjacent sidewalk
- 3) Distance from the proposed parklet to the nearest crosswalk or intersection
- 3) Name and location of adjoining streets or alleys
- 4) North arrow
- 5) Parklet dimensions

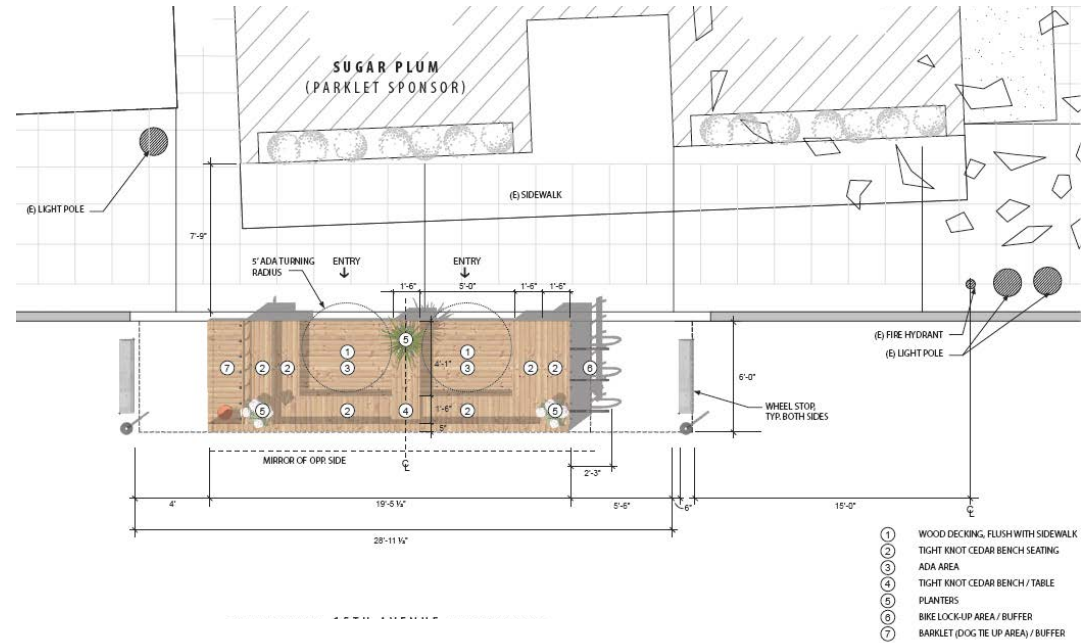

Image: Graham Baba Architects

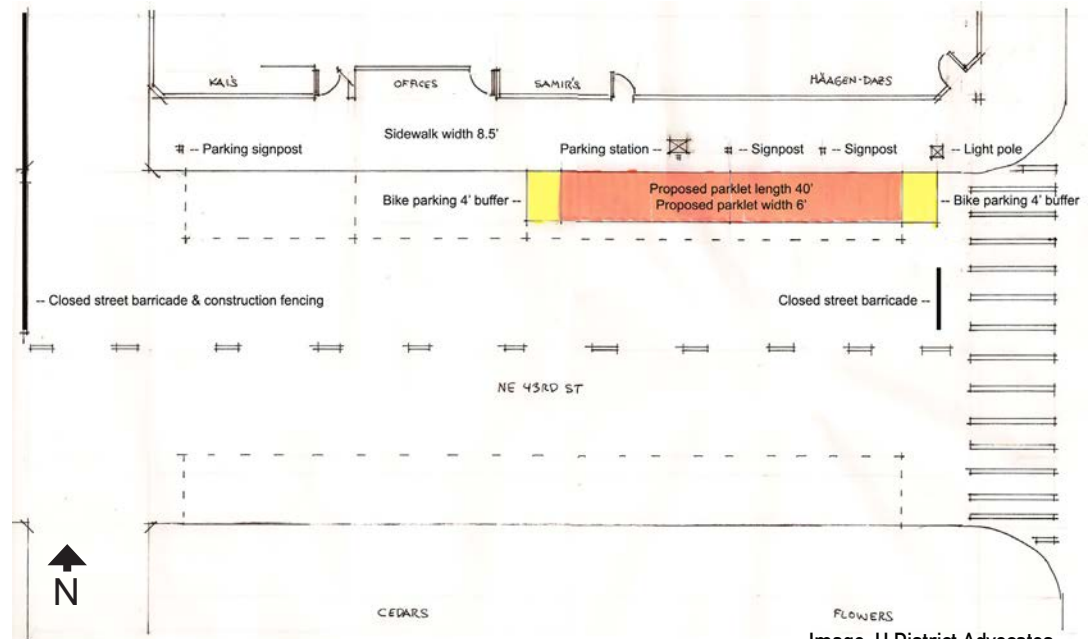

Image: U District Advocates

PHOTOS OF THE AREA

The application should include at least 3 photos showing the proposed parking space(s) that would be converted into a parklet, along with the adjacent street and sidewalk. At a minimum, please provide one photo from across the street and one photo from each end of the proposed parklet. Photos of nearby parking signs that show the parking restrictions for the spaces you'd like to use are also helpful.



SELECTION CRITERIA

Once we receive your application, we'll evaluate it based on its proposed location, the demonstrated level of community support, and the programming intentions for the space. This review allows us to ensure that your proposed parklet is supporting the goals of the program. Our review team uses the following criteria to assess the applications before we formally accept you into the Parklet Program:

PARKLET LOCATION—Is the parklet sited in a feasible location that would successfully activate the public right of way without negatively impacting businesses, residents, and other users of the street?

PROGRAM AND DESIGN APPROACH—Would the proposed program and design for the parklet enable it to provide a valuable and attractive public space?

COMMUNITY SUPPORT—Are neighborhood businesses, residents, and/or community groups supportive of the proposal?

RACE AND SOCIAL JUSTICE—Would the proposed parklet bring a positive community amenity to an underserved area of the city? Would it seem open and welcoming to all?

PARKLET HOST—Does the host demonstrate an understanding of the intent and function of parklets? Do they have a plan for managing and maintaining their parklet?

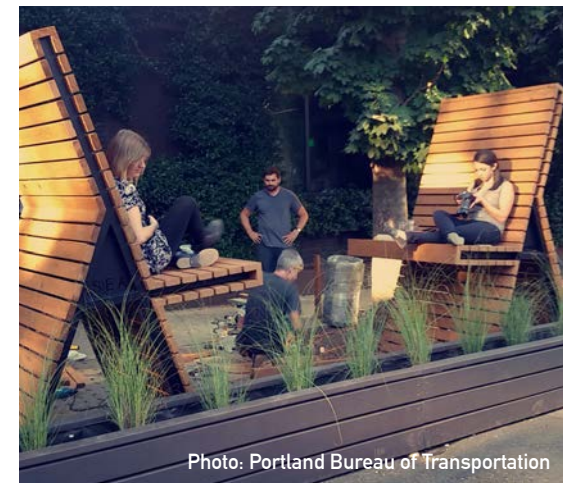

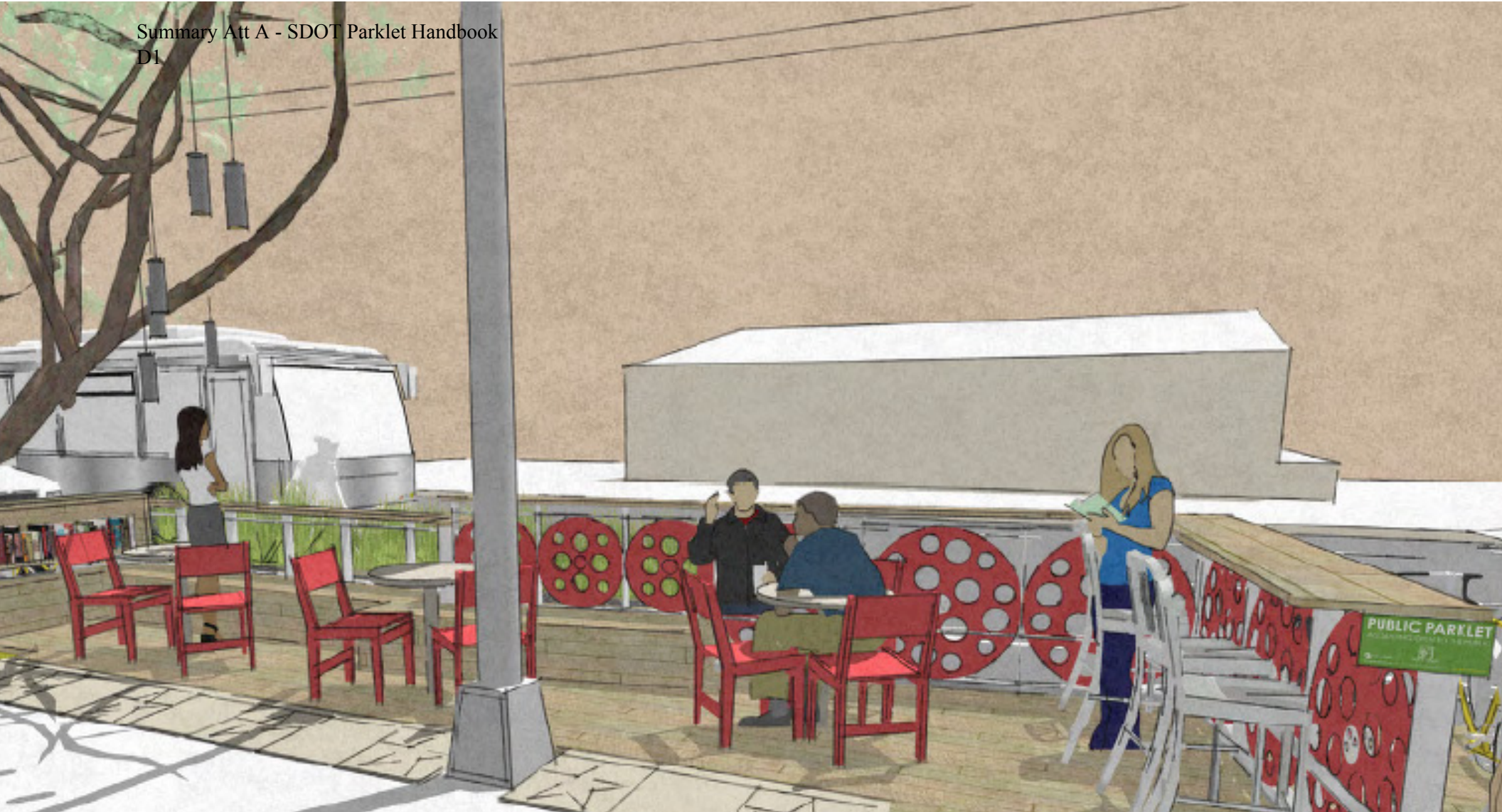

DESIGN DEVELOPMENT

Assemble a Design Team

Prepare Concept Design

Public Space Permitting

Public Notice

DESIGN DEVELOPMENT

ASSEMBLING A TEAM

Ok, your application has been accepted and you've got the green light to start design! Now what? Hopefully you've already been thinking about this, because it's time to assemble your design team.

What if you're a designer who's familiar with building structures and applying for permits? Well, that makes your team selection easy! But since not everyone has that expertise, this is where your design team comes in. There are 2 roles that need to be filled. Whether it's you, someone you hire, or a volunteer, the design team will take your initial idea and turn it into a concept design that meets the parklet standards. And then your builder eventually will be the one to bring your design to life.

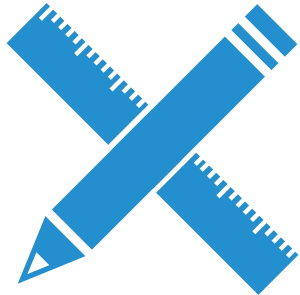

1) **DESIGNER:** This person or team will take the sketches and doodles you've made and turn them into concept design graphics. The designer must be familiar with measuring dimensions, drawing site plans and elevations, and producing graphics. They will make sure that the parklet design fits where it's supposed to and that it looks good. They will also be thinking about what materials to use for the parklet and how to integrate plantings into the parklet's design.



2) **BUILDER:** This person or team will figure out where to get materials and how to put them together. They should be familiar with detailed construction documents and understand how to make sure the parklet structure will stay up and look good during the wear and tear of weather and regular use.

DRAFT CONCEPT DESIGN

Now that your team is in place, the next step is to prepare and submit your draft concept design. Parklet concept designs are hand drawings or computer renderings of your parklet that show how the parklet will be built and how it will function. These graphics allow us to review how well your proposed parklet integrates with the surrounding street and sidewalk features and determine if the design should be modified to improve the parklet's function, safety, or aesthetics.

Parklet concept designs must include a detailed, fully dimensioned plan (overhead) view, as well as a dimensioned section (side) view drawing, and 2 or more perspective views. At a minimum, you should prepare a perspective from the sidewalk next to the parklet and another from across the street. Examples of a site plan and the types of drawings and perspectives that are required for the concept design are provided on the next page. Be sure to follow the parklet design guidelines listed in this chapter when preparing your concept drawings.

The concept drawings must show the following features:

- Dimensions of the parklet, including the width and length of the parklet and the height of all vertical elements
- Arrangement of all attached and removable furniture, amenities, and landscaping
- Basic materials used for the parklet surface, railing, and other attached elements (note that specific details about materials, such as the type of wood used for the surface or the diameter of fencing cable, do not need to be provided at this phase)
- Parklet entrances, including Americans with Disabilities Act (ADA) access points
- Proposed installations adjacent to the parklet (e.g., bike racks, wheel stops)
- Adjacent street elements (e.g., trees, tree pits, utility poles, signs) with distance from the parklet
- Adjacent sidewalk, bike lane, vehicle travel lane, and buildings
- Setback dimensions from adjacent parking spaces and the nearest crosswalk or intersection



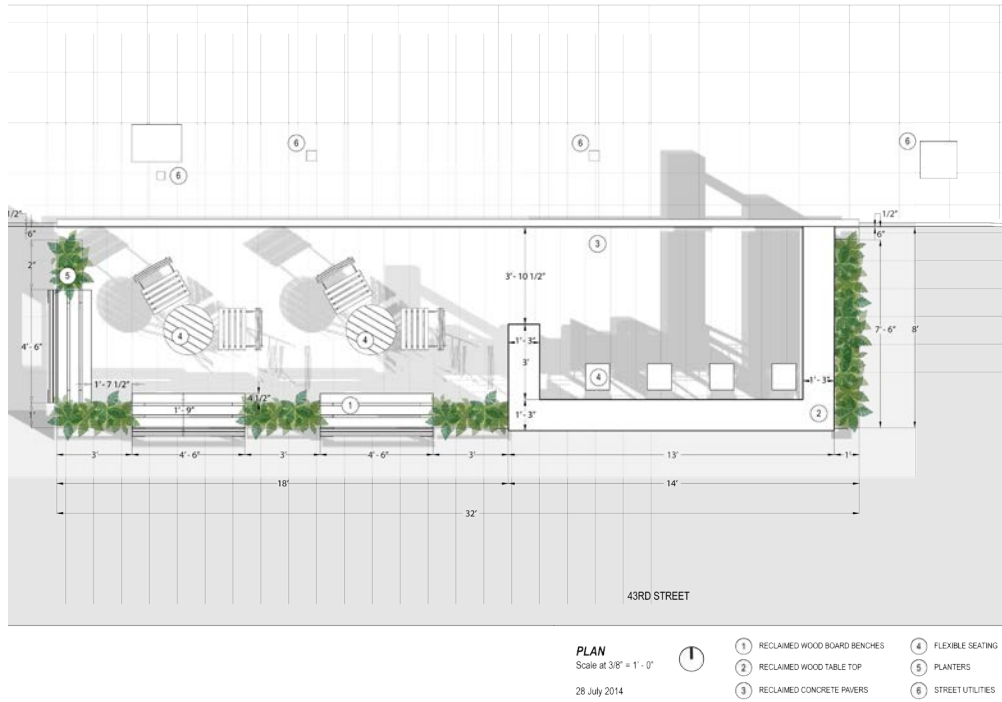

Sample Site Plan

Sample Perspective View

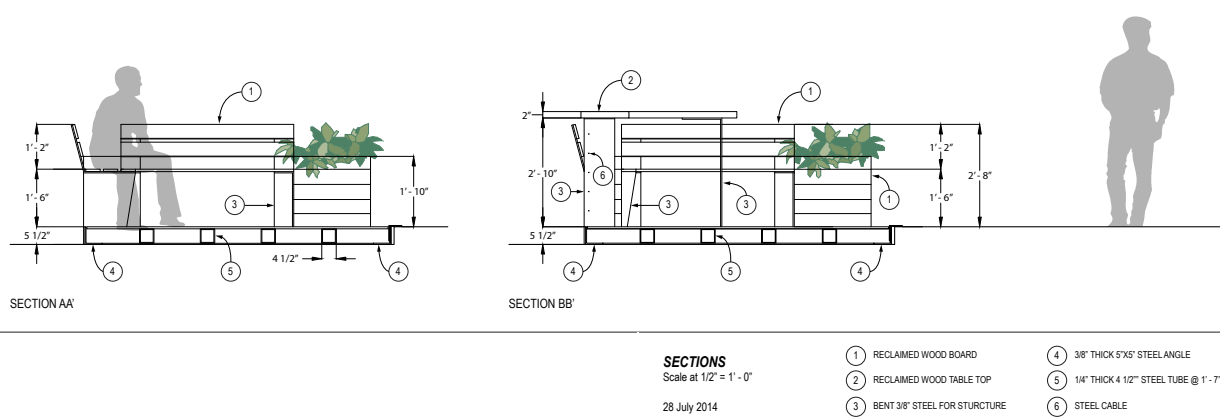

Sample Section Drawing

Images: Jordan Lewis, Stella Chen, and U District Advocates

CONCEPT DESIGN REVIEW

Once your initial concept design is submitted, we'll review the drawings and give you feedback. Concept designs are reviewed to assess the parklet's safety, accessibility, aesthetics, basic materials, and overall function. The turnaround time for reviews is generally about 2 to 3 weeks but can be longer depending on the availability of staff time and the complexity of your site.

When we provide feedback on your concept design, we'll ask you to revise your design and resubmit the drawings. Remember that design is an iterative process—it may take several rounds of review before we can consider your concept design "final."



Photo: Capitol Hill Seattle Blog

HISTORIC/LANDMARK DISTRICT APPROVAL

If your proposed parklet is located within one of Seattle's [landmark or historic districts](#), you must receive a Certificate of Approval from the district board before we can issue any permits for your parklet. It's a good idea to begin discussions with the district board early in the design process so that you can incorporate the board's feedback into your concept design and expedite their approval.

PUBLIC SPACE PERMITTING

Once your concept design has been approved, you can apply for your Public Space Permit. This requires the following materials:

- Two 11"x17" printed copies of your concept design
- A \$516 review fee
- A signed and completed Public Space Permit form (see Supplements document)

These documents must be submitted to the Street Use permit counter on the 23rd floor of the Seattle Municipal Tower (700 5th Ave).

PUBLIC NOTICE

After you've applied for your Public Space Permit, we will issue a public notice of your parklet application and hold a 14-day public comment period. Notices of your application will be posted to the SDOT Street Use website, mailed to businesses and residents within 200 feet of the proposed parklet site, and posted in a window adjacent to the site so that it is visible from the sidewalk. The notice forms include detailed information on the proposed parklet, comment period dates, and information about how the public can submit a comment.

After the close of the public comment period, we will carefully review each of the comments we receive and then issue a decision to approve, modify, or deny the Public Space Permit application. We will post the decision on our website and send a note to everyone who commented on the application. The public then has 10 calendar days to request a review or reconsideration of the decision.

PARKLET DESIGN GUIDELINES

The following design guidelines ensure that all parklets are safe, accessible, attractive, and functional. To make your parklet a welcoming gathering space, it should feature high-quality materials and built-in elements like benches or seats and landscaping. You should think about what people will do in your parklet and the kinds of activities you want to promote. Locally-sourced or reclaimed materials are strongly encouraged.

FOOTPRINT

LENGTH: The minimum length for a parklet and its required safety features is 20 feet. With 4-foot buffers on each end (see below), this means the smallest parklet structure would be 12 feet long. While there is no maximum length for a parklet, proposals that use more than 2 parking spaces (more than 40 feet) will require additional SDOT review.

WIDTH: In locations with parallel parking, the maximum parklet width is 6 feet, measured from the curb. There must be a 1-foot setback from the edge of an adjacent bike lane or vehicle travel lane. A wider parklet may be possible on streets with back-in angle parking.



MINIMUM DIMENSIONS

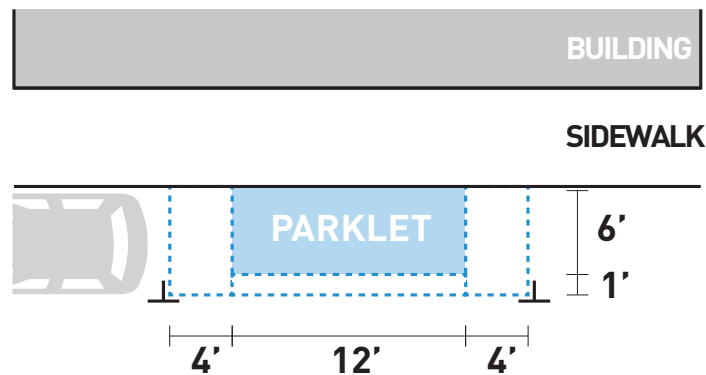

DOUBLE SPACE DIMENSIONS

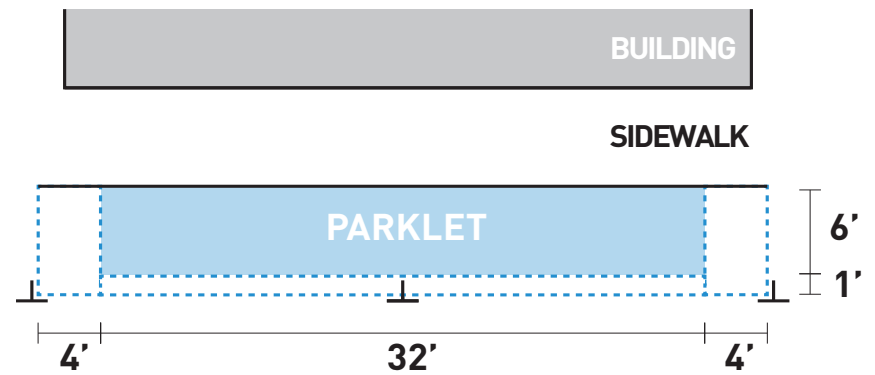

BUFFER

To ensure visibility and to protect your parklet from parking cars, we require a minimum 4 foot buffer on both ends of the parklet. If your parklet is at a corner, the buffer is not required, but you must leave at least 5 feet between your parklet and the stop bar at an intersection.

Wheel stops must be installed at the back of the buffers to prevent people from parking too close to your parklet. To enhance visibility, reflector posts are required at the outside corners of the buffers.

We encourage you to install amenities, such as bike racks or large planters between your parklet and the wheel stops. However, these amenities will increase the size of your buffers, and the wheel stops must be set back at least 4 feet from any amenities in the space. Please see the Building Your Parklet chapter for additional details.



MID-BLOCK BUFFER

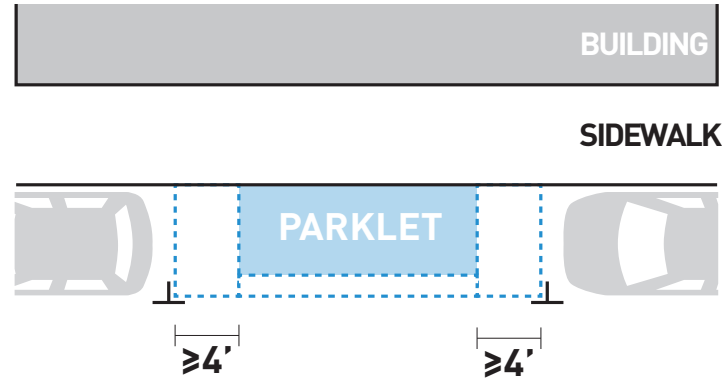

CORNER BUFFER

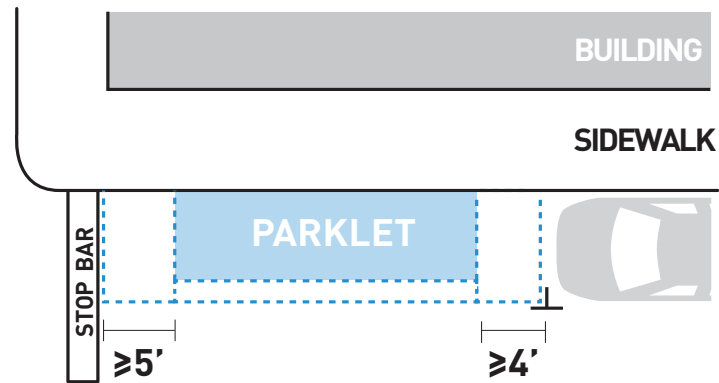

WHEEL STOP & REFLECTOR POSTS

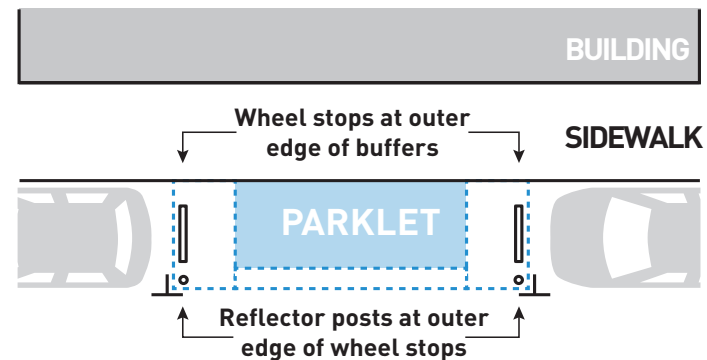

VERTICAL ELEMENTS

The parklet must have a continuous edge along the travel lane, such as railings, planters, or seat walls. This edge helps to increase visibility for road users and should be at least 30 inches tall, as measured from the street surface.

Any portion of your parklet that is located within 20 feet of a crosswalk must be visually transparent and may not exceed 36 inches in height (including plantings). This ensures that sight lines for pedestrians remain clear at crosswalks. Please be aware that legal crosswalks at intersections are not always marked.

Overhead weather protection is a great feature that can be included in your parklet design. Overhead features may not extend beyond the street edge of the parklet and must be at least 8 feet high if over the sidewalk. If Metro trolley wires are present, there needs to be 11 feet clear between the wires and the top of your parklet.



MAXIMUM HEIGHT NEAR CORNERS

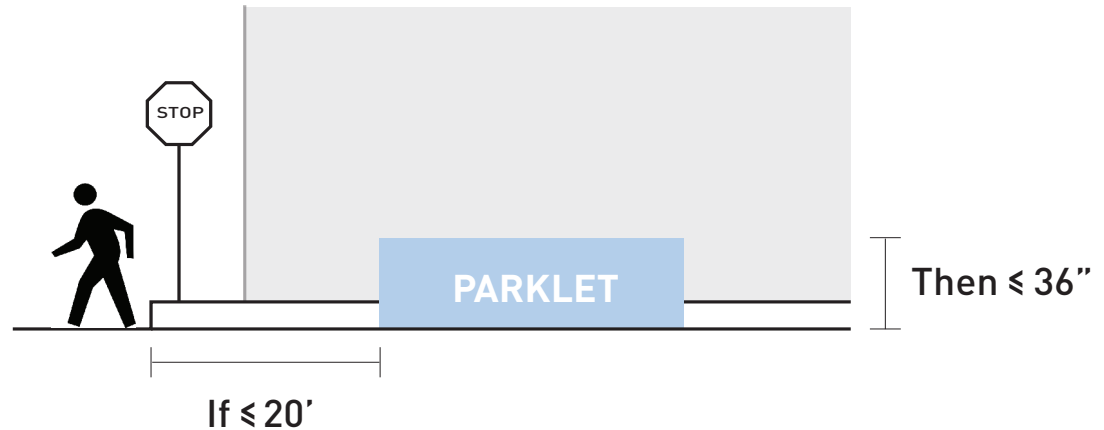

MINIMUM HEIGHT

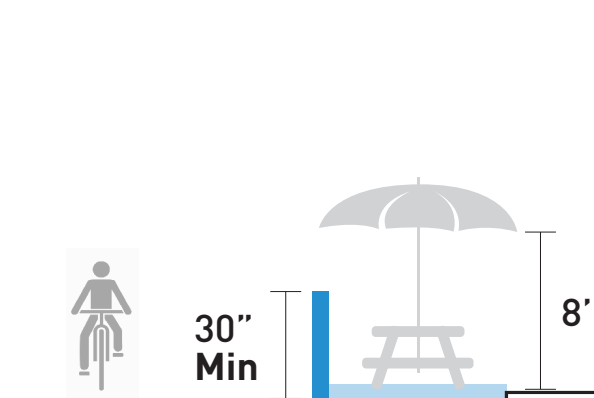

DISTANCE TO TROLLEY WIRES

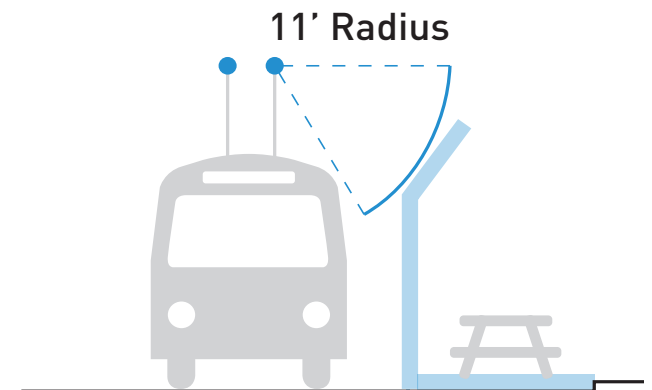

FRAME AND DECK

The parklet frame should be a freestanding structural foundation that rests on the street surface. This frame can't be permanently attached to the street, curb, or adjacent planting strip. You may, however, use small pin bolts to attach the parklet to the street.

The parklet must be designed to allow rainwater to flow along the curb without obstructions. To satisfy this requirement, you should use a pedestal support system for the parklet frame so that rainwater can pass underneath the entire width of the structure. There must also be a minimum 6-inch horizontal gap between the curb and the base of the frame and a minimum 2-inch vertical gap between the street surface and the bottom of the parklet decking.

The entire parklet structure should be built to allow for easy removal of the parklet if necessary. Concrete may be used as long as you use a plastic slip-sheet or similar material to prevent the concrete from binding to the street. The weight of the deck should be less than 200 pounds per square foot.

The height of the deck surface should be flush with the adjacent sidewalk. A maximum horizontal gap of 1/2 inch between the curb and the deck is allowed (exceptions can be made to address Americans with Disabilities Act (ADA) requirements). Slatted lumber, wood tiles, and precast concrete pavers allow rainwater to drain off the parklet surface and are good choices for decking material.



DRAINAGE & DECK GAP

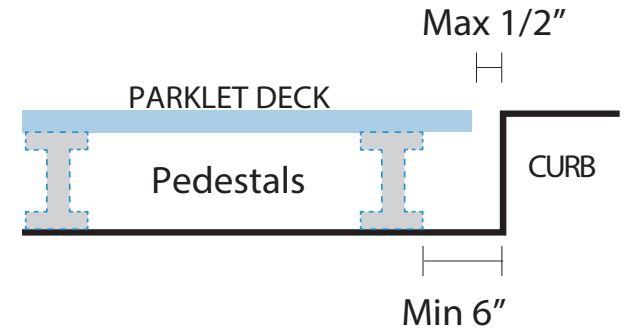

ATTACHING TO THE STREET

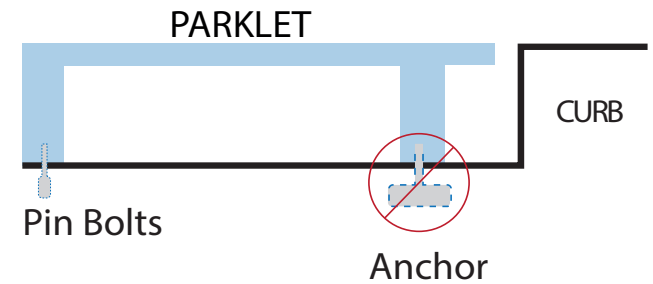

VERTICAL DRAINAGE GAP

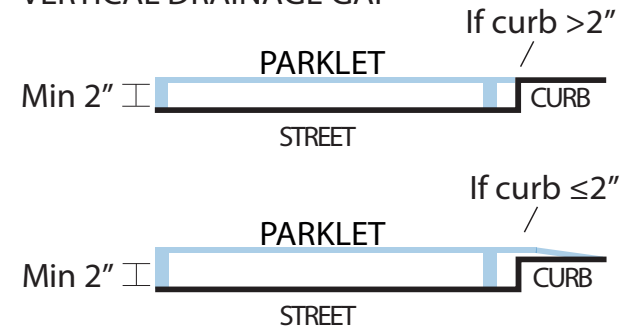

MATERIALS

The parklet should be constructed of high-quality, durable, non-reflective, and aesthetically-pleasing materials. Steel, finished woods, salvaged building materials, and sustainably sourced materials are recommended.

All walking surfaces should be non-slip and weather resilient to ensure safety and accessibility. Since parklets are intended to be temporary structures, it is also important to consider the ease of disassembly and potential for recycling or reuse of materials.



Photo: Matarozzi Pelsinger Builders and Wells Campbell Photography



Photo: Samuel Heller and SF Planning

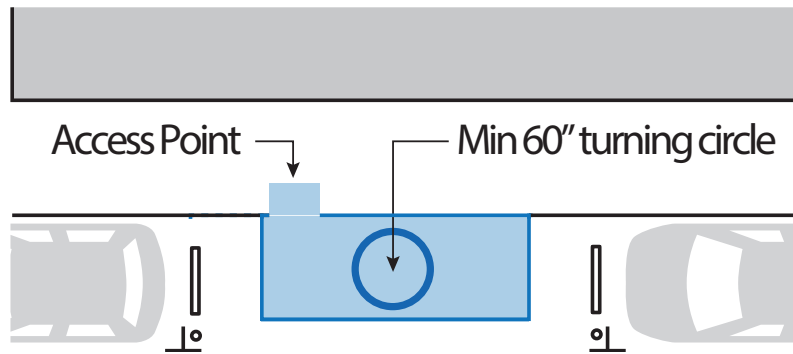

Photo: Portland Bureau of Transportation

ACCESSIBILITY AND ADA

We want everyone to be able to use and enjoy parklets, whether they are on foot, in a wheelchair, using a walker, or in a stroller. To achieve this goal, the parklet must be accessible as required by the Americans with Disabilities Act (ADA). The design should incorporate at least one ADA access point for each parking space used for the parklet. Seating must be accessible and meet ADA requirements for the turning movement (60" diameter turning circle) and the resting space of a wheelchair. The maximum vertical difference between the curb and the parklet decking is $\frac{1}{4}$ inch. Additional ADA treatments, such as a ramp or beveled edge, may be required if the vertical gap exceeds $\frac{1}{4}$ inch.

ADA ACCESS



MAXIMUM VERTICAL DIFFERENCE

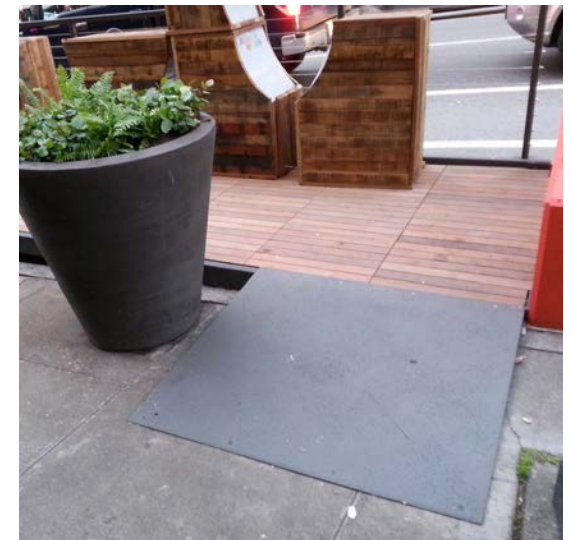
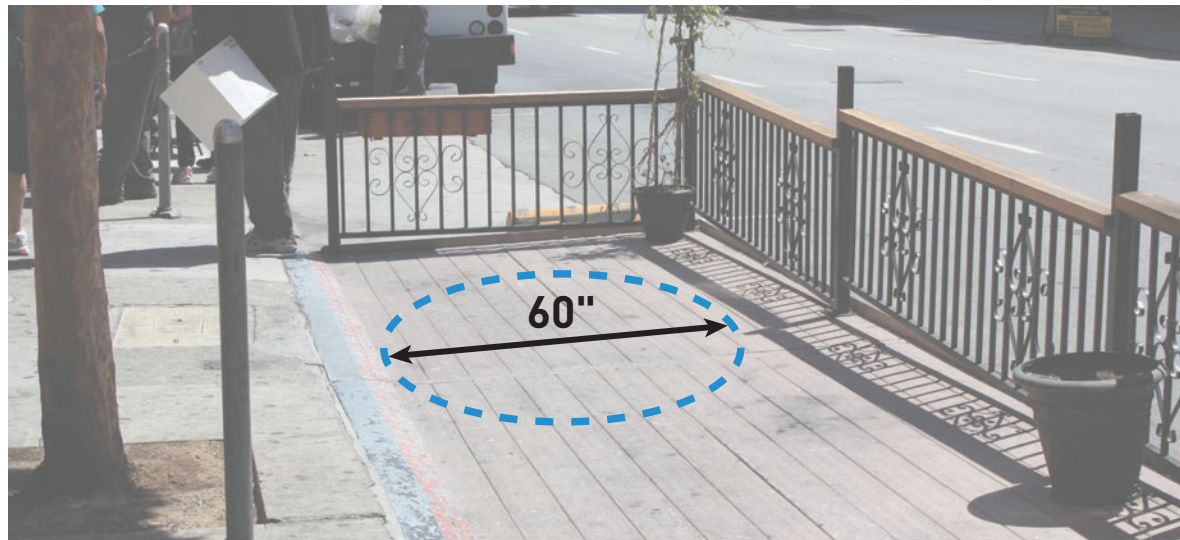

USE OF PARKING AND LOAD ZONES

Parklets that use more than 2 parking spaces will require additional review so that we can look closely at parking needs nearby, such as the number of load zones, on-street, and off-street parking spaces and how full they tend to be.

If you are considering putting a parklet in a load zone or another designated zone, we recommend that you talk with other businesses on your block about how they use that space. Load zones are used for deliveries and passenger drop-offs, so we'll need to ensure that these functions can be maintained if the load zone is relocated or removed. You may need to provide written acknowledgment from your neighbors if you're planning to use a load zone for your parklet.



USE OF THE SIDEWALK OR PLANTING STRIP

In some locations, it may be possible to extend your parklet onto the adjacent planting strip or sidewalk. Proposals will be considered on a case-by-case basis to ensure that adequate sidewalk width is maintained and that street trees are protected. There are a few rules to consider if you'd like to include the planting strip or sidewalk in your parklet.

Street trees provide greenery, shade, and habitat for urban wildlife. If there is an existing street tree and vegetated planting strip at your parklet site, our priority is to protect the tree. When designing your parklet, access to the space should be planned in a way that does not direct foot traffic through the tree pit. Placing benches, planter boxes, and other structures in the tree pit is not allowed.

Where the existing planting strip is paved, it may be possible to extend the parklet onto the pavement. We'll work with you to evaluate the feasibility of your proposal and ensure that minimum sidewalk clearances are maintained.



AMENITIES



SEATING

All parklets must incorporate built-in seating, which can be integrated in a variety of creative ways. These seats can be a part of the parklet structure, planters, or creative features within the parklet. Comfortable places to sit are important to creating welcoming and inviting public spaces.

Additional movable seating is recommended as well. This seating can be removed and stored at the end of the day or locked with cables to the parklet structure.

Parklet furnishings should be distinct from any furnishings used by the hosting business or organization. If the parklet host is a business with a sidewalk café, the tables and chairs must be a different style from the ones used in the café. It is important to remember that the parklet is a public amenity, and as such, should be easily distinguishable from nearby private property.

LANDSCAPING

Your parklet must have some type of landscaping. Landscape plantings help soften the space and can serve as a pleasant buffer along the street-facing parklet edge. Landscape elements may be incorporated as planter boxes, hanging planters, green walls, or ADA-accessible raised beds, for example. Drought-tolerant and native plants are good choices for ease of maintenance. Edible plants and plants with fragrance, texture, and seasonal interest are also recommended.

Refer to the Supplements document for additional plant recommendations and resources.



LIGHTING

Lighting is allowed but may require a [Utility Permit](#), depending on what you propose. Self-contained low-voltage systems, such as solar or battery-powered lights, are a good choice. Decorative or seasonal lighting may be allowed in street trees near the parklet, but requires an [Urban Forestry Permit](#). Flashing lights and cords that extend over the sidewalk are not allowed.



BICYCLE PARKING

Whether integrated into the parklet structure or installed on the street next to the parklet, bike parking is encouraged. In fact, we can provide on-street bicycle racks at no charge. Please see the Building Your Parklet chapter for additional details.



SIGNS

All parklets must feature SDOT-provided signs indicating the space is public. These signs should be mounted to both ends of the parklet and should be visible from the adjacent sidewalk. Signs acknowledging sponsorship, logos, or designs that “brand” the parklet must comply with the City of Seattle sign code ([SMC 23.55](#)).



ARTWORK

Art can enhance the attractiveness of and create identity for your parklet. Some parklet hosts have integrated permanent artwork into the design of their parklets, while others have dedicated spaces in their parklets for rotating installations.

The space for and programming of your art installations should be clearly indicated in your concept drawings. Some art, depending on size, design, and placement, may require additional review.



HEATING AND GAS POWER

Outdoor heaters and elements that use gas or propane fuel can help to make your parklet more comfortable throughout the year. Heating and gas-powered features are allowed in parklets but will require an additional [Seattle Fire Department Permit](#).



PLAY EQUIPMENT

The most successful parklets are those that are comfortable, accessible, and enjoyable for people all ages. We encourage you to incorporate play elements in your parklet to make it a fun place for children (and adults) to spend time.

Play equipment may include integrated toys, games, or swing seating. These features can be creatively integrated into the parklet structure or can be movable.



Photo: Thurston County Chamber of Commerce

OVERHEAD WEATHER PROTECTION

Adding weather protection over your parklet seating area is strongly encouraged to make the parklet comfortable to use throughout the year. Weather protection can be provided through a variety of fixed and retractable canopies, awnings, and umbrellas. If you're thinking of covering your parklet, you'll need to be aware of height restrictions and setbacks from Metro trolley wires. Please see the Vertical Elements section on page 29.



SURFACE PAINTING

Depending on the location, it may be possible to paint the street adjacent to your parklet. Street painting will be considered on a case-by-case basis and will require additional review.



ACTIVATION AND PROGRAMMING

Activation and programming, or how the parklet is used, is an important part of the parklet's design and an opportunity to get creative. The parklet may be a simple space for relaxation or it may have more interactive features, such as art, music, play equipment, or outdoor games.



TECHNICAL DEVELOPMENT



TECHNICAL DEVELOPMENT

CONSTRUCTION DOCUMENTS

Ok. You've got a good design, a location that could use a parklet, and a community that's on board with your idea. Now it's time to finish your permitting and get ready to build. The last step to getting your Public Space Permit is upgrading your conceptual design drawings to a technical level for final review and approval. We will review this last set of drawings in detail to make sure that your parklet will look and function as intended throughout its life in the public right of way.

Examples of the required construction documents are in the Supplements, and you're welcome to schedule a visit to the SDOT Street Use Office on the 23rd floor of the Seattle Municipal Tower (700 5th Ave) if you'd like additional guidance on the drawings you'll need to prepare and the fees you'll need to pay.

For the technical review, we'll need a complete set of construction documents that are drawn to scale, showing the dimensions, materials, assembly details, and landscape plan for the parklet. A detailed checklist of requirements is available in the Supplements. For

this review, we prefer PDF documents in tabloid (11" x 17") format. Your construction documents must include:

1) LOCATION AND CONTEXT PLAN

This plan should show your parklet in relation to the surrounding context, including buildings, property lines, intersections, driveways, bike and traffic lanes, and street features (e.g., trees, utilities, fire hydrants). This plan should also display dimensions of the parklet footprint, the adjacent sidewalk, and surrounding parking spaces.

2) ACCESSIBILITY PLAN

The plan should show elevations on the sidewalk and street as well as wheelchair paths, rest areas, and turnaround spaces within and next to your parklet.

3) DETAILED SITE PLAN

This top-view drawing of your parklet should show the dimensions of your parklet and its various elements, along with the different plant species and materials included in the design.

4) ELEVATIONS

These side-view drawings of your proposed design should display parklet dimensions (including height), materials, parklet elements, and buffers.

5) SECTION DIAGRAMS

These "cut-through" drawings are similar to the section drawings submitted with your concept design package, but should more clearly articulate complex design elements, such as how accessibility and drainage are accommodated.

6) CONSTRUCTION DETAILS

The construction detail diagrams should show the nuts and bolts (literally!) of how you plan to assemble your parklet. These drawings should highlight the hardware and fasteners that you will use in the construction process, as well as how you will maintain drainage flow along the curb.

7) PERSPECTIVE RENDERINGS (optional)

Additional three-dimensional perspective drawings of the completed parklet are helpful, but not required.

CONSTRUCTION USE PERMIT

During this phase of the process, we'll also need to learn how you plan to use the street and sidewalk when you install your parklet. Since some of your assembly work will occur in the right of way, you'll need to obtain a Construction Use Permit before installation begins. For this permit, you must submit a Construction Use Permit Application form and a site plan showing the area in the right of way that you plan to use during construction. A traffic control plan (TCP) will also be required if your work will impact mobility on an arterial street or is located in a [construction hub](#). The review of the TCP will incur an \$98 fee. Templates and samples of these documents are provided in the Supplements.

We recommend submitting your permit application materials at least 3 weeks in advance of construction on non-arterial streets or 4 weeks in advance of construction on arterial streets. If you're unsure whether your parklet will be on an arterial street, check SDOT's [street classification maps](#).

In order to minimize the impacts of construction and expedite your permit approval, we suggest that you avoid closing bike paths, vehicle travel lanes, and sidewalks during construction. However, in some cases, you may need to close these areas, which will require submitting a TCP.

LIABILITY INSURANCE

As with most types of Street Use Permits, you must carry \$1 million in commercial general liability insurance for your business or organization and add the City of Seattle as an "additional insured" to your policy. This is a minimal cost for businesses or organizations that already have liability insurance, although you must provide us with a certificate of liability insurance before we can issue your permit. All insurance requirements are detailed in Client Assistance Memo 2102, which is included in the Supplements.





BUILDING YOUR PARKLET

Pick Up Permits & Pay Fees

Installation

Safety Elements & Bike Parking

Opening Celebration!

BUILDING YOUR PARKLET

PERMIT ISSUANCE & FEES

After the technical review of your construction documents is complete we'll be ready to issue your Public Space and Construction Use permits.

The last thing we'll need is payment of your permit fees.

The fees due at this time will be either \$647 or \$745, depending on whether a traffic control plan is required. All fees can be paid either in person at the Permit Counter on the 23rd floor of the Seattle Municipal Tower (700 5th Ave) or on the SDOT Street Use website (http://www.seattle.gov/transportation/stuse/permits_online.htm).

See the Pre-Planning chapter for a breakdown of the fees.

INSTALLING YOUR PARKLET

When we issue your final Construction Use Permit, our staff will advise you on site-specific considerations related to your permit:

- Prior to starting construction, you will be responsible for placing temporary “No Parking” signs adjacent to the parking spaces you plan to use for the parklet. This is a 2 step process that requires you to rent “No Parking” sign easels from a traffic control vendor and attach a self-verification form to the easels. The signs must be placed in the right of way 72 hours in advance of the day you start building. See Client Assistance Memos 2112 and 2114 in the Supplements for additional information.
- You'll also be responsible for ensuring that all nearby trees in planting strips and tree pits are protected during parklet construction. The tree root zone should not be used to stage equipment or stockpile materials. Tree protection fencing should be used to mark a minimum 4-foot tree protection root zone around the trunk.





Photo: SF Planning

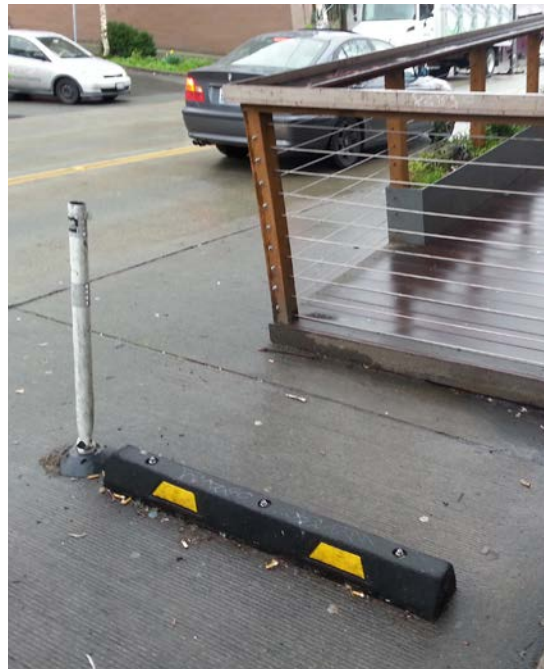

OFF-SITE CONSTRUCTION

We recommend that you spend as little time building in the right of way as possible by starting your parklet construction off site. Contractors often find that they can prepare materials and build the parklet frame on private property before delivering it to the parklet site.

PARKLET SAFETY ELEMENTS

During construction, you must install wheel stops and reflective delineator posts at the outside edges of your parklet buffer. Wheel stops must be placed on each end of the parklet that borders a parking space. The wheel stops must be mounted 4 feet back from the edge of the parklet and 1 foot out from the curb, although this distance may be increased to accommodate bike racks or other amenities. The delineator posts must be placed 6 inches out from the corners of the wheel stops (see diagrams in the Design Development chapter).

You must purchase wheel stops that are 4 feet long and bolt-mounted. Recycled rubber wheel stops are recommended. Delineator posts must be 36-inch tall, cylindrical, white flexible posts and must include reflective striping. These posts should use a surface mount pin-lock base and be attached to the street with either an adhesive pad or epoxy kit. There are several local vendors that sell these items; it's a good idea to purchase them well in advance of your construction in case they're not in stock.

PARKLET SIGNS

We'll provide you with 2 "Public Parklet" signs to install on both ends of your parklet. These required signs should be installed in places that are highly visible to passing pedestrians. The signs can either be bolted to the parklet or mounted using their adhesive backing.



ON-STREET BICYCLE PARKING

Many parklet hosts choose to include on-street bike parking in their parklet designs, and we love that. Parklets and bikes go great together! If you would like bike parking next to your parklet—and if your parklet is on a street where this is possible—you can either design and install the bike racks yourself or request a standard SDOT rack. While host-designed racks are often more artistic and unique than the standard SDOT racks, SDOT racks can be installed by our crews free of charge and are a good option if you're on a tight budget. Please let us know early in the design process if you'd like a standard SDOT rack.

We need to approve all non-standard bike racks, so be sure to include them in your plans. Also, if you choose to install a rack yourself, be sure to leave at least 4 feet of space on either end of the rack to give people biking plenty of space to use the rack.



Photo: Molly Moon's Ice Cream





CELEBRATION!!

Once your parklet is built and ready to open to the public, it's time to celebrate with your team and neighborhood! You've all put in time, effort, and funding to make this happen, so think about creative ways to show off your shiny new public space (ribbon-cutting ceremony, potluck, music performance, dance party...) and thank all of the people who helped make it possible. Be sure to let us know about the plans for your opening celebration so we can help get the word out.



Photo: Alex Garland





POST-INSTALLATION

Cleaning & Maintenance

Permit Renewal

Disassembly & Removal

Evaluation

POST-INSTALLATION

MAINTENANCE

Parklet hosts manage the upkeep of their parklets. This means that you're responsible for all maintenance duties and costs to keep your parklet in good condition. You should clean your parklet and the surrounding area on a daily basis, clear the drainage channel, stow or lock movable furniture every night, and repair any damage to the parklet. Proper maintenance is a condition of the parklet permit, and we will ask you to sign a maintenance agreement before the permit is issued. A copy of this agreement is provided in the Supplements.

Prior to submitting an application, please be sure that you will have sufficient resources and staff available to keep your parklet clean and in a state of good repair. If you're hosting the parklet as a community group, you may need to work with nearby businesses or community members to ensure that your parklet is monitored on a regular basis and that all cleaning and maintenance is covered.

PERMIT RENEWAL

Parklets are permitted under a Public Space Permit, which must be renewed once a year. The annual renewal fee is \$140, and we'll send you a renewal notice and invoice prior to the anniversary date of your permit.

An inspector will visit your parklet around the time of permit renewal and will work with you to ensure that any maintenance, safety, or accessibility issues get resolved. Also, remember to make sure your liability insurance policy is up to date before renewing your permit.



PARKLET EVALUATION

After you install your parklet, we want to know how it's doing! To better understand how parklets are serving Seattle's neighborhoods, we need parklet hosts to help us by providing some basic information. We'll be visiting your parklet regularly after it's installed to count the number of people in the parklet and record how it's being used.

In addition to the observational data we collect, we'll ask you to respond to a few surveys and provide us with sales data (if you're a business) from before and after the parklet installation. This information will help us measure the impact of parklets on business success and evaluate how they add to the economic vitality of Seattle's commercial districts.

CHANGE OF OWNERSHIP

If your business changes ownership or your community group dissolves, you may choose to either transfer the parklet permit to a new host or remove the parklet.

Please contact us at parklets@seattle.gov or (206) 684-5267 if you would like to transfer your permit.

MAKING CHANGES TO YOUR PARKLET

As a parklet host, you're welcome to make minor changes to your parklet after it's installed. This might include changing the type of movable furniture in the parklet or putting in new plants. However, anything that changes the materials, function, footprint, and/or significantly alters the appearance of the parklet must be reviewed by SDOT to ensure compliance with your permit.

Major modifications, such as extending a parklet's decking, may require a new permit.

PARKLET REMOVAL

A parklet must be constructed and installed in a way that allows you to easily remove it when needed.

In rare circumstances, we may require that you temporarily or permanently remove your parklet. You must be able to do so within 30 days of our notice. The City reserves the right to remove your parklet if emergency work needs to be conducted. As the parklet host, you are responsible for all costs associated with the disassembly and removal of your parklet.

The Parklet Support and Maintenance Agreements in the Supplements document specify several conditions under which removal may be required.

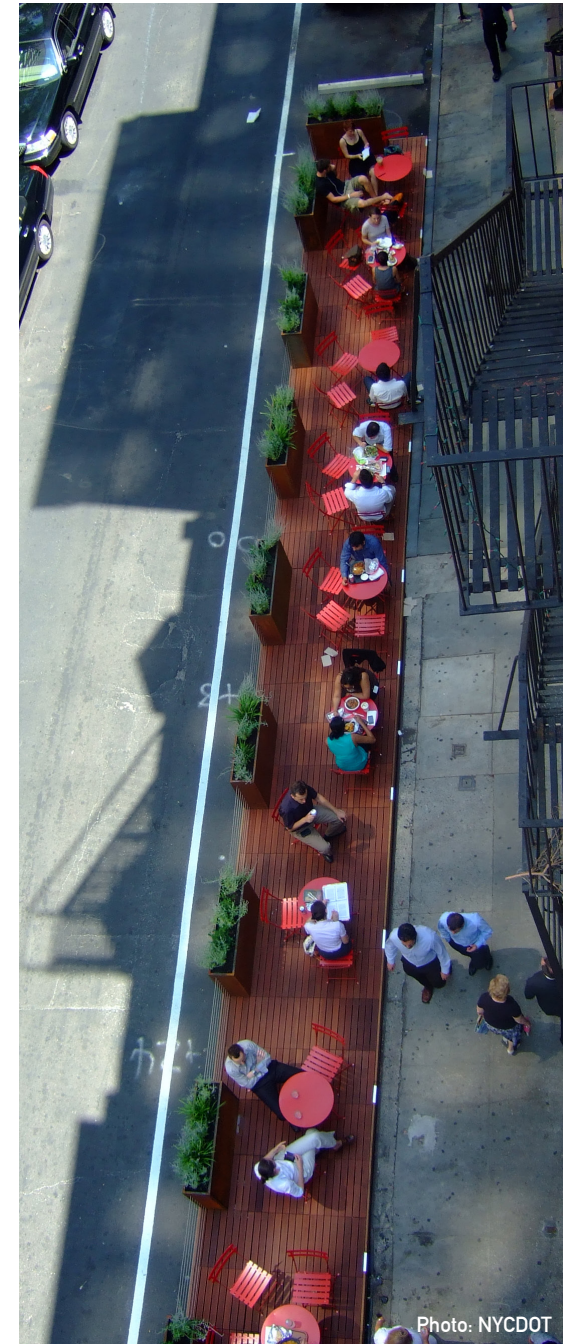



The Seattle Department of Transportation
700 5th Avenue, Suite 3800
PO Box 34996
Seattle, WA 98124-4996
(206) 684-ROAD (7623)
www.seattle.gov/transportation

