

**THE CITY OF SEATTLE - SEATTLE PUBLIC UTILITIES DEPARTMENT
GROUND LEASE AGREEMENT
T14-802**

THIS GROUND LEASE AGREEMENT (“Ground Lease”) is made by and between The City of Seattle, a municipal corporation of the State of Washington, by and through its Seattle Public Utilities Department, having offices for the transaction of business at 700 Fifth Avenue, Suite 5200, Seattle, Washington 98124-4689 (collectively, “SPU”), and King County, a political subdivision of the State of Washington, having offices for the transaction of business at 500 Fourth Avenue, Suite 830, Seattle, Washington 98104 (“Lessee”). SPU and Lessee may jointly be referred to herein as the "Parties," or individually a “Party.” The “Effective Date” of this Ground Lease shall be the last date signed by an authorized Party representative.

WHEREAS, SPU is the owner of a series of contiguous real property parcels that geographically link the Tolt Watershed to the City of Seattle and together make up the necessary and critical corridor for the Tolt Water Supply System located within King County, Washington (the “Tolt Water Corridor”); and

WHEREAS, Lessee desires to lease from SPU a portion of one of the parcels located within the Tolt Water Corridor, which parcel is more specifically set forth in Exhibit A annexed hereto (“Property”), to construct, operate and maintain a communication facility, including but not limited to a tower, communications equipment shelter, auxiliary power generator and associated equipment and improvements, as well as obtain the rights from SPU to access the property and install utilities in conjunction therewith; and

WHEREAS, the Lessee plans to fund and procure sites for such communication facilities, and along with other municipalities in King County establish the Puget Sound Emergency Radio Network (the “PSERN System”) to eventually provide service in King County as authorized by Proposition 1 and King County Ordinances 17993, 18074 and 18075; and

WHEREAS, the Lessee plans to later assign this Ground Lease and the communication facilities to a governmental entity or to any entity existing now or in the future that will be responsible for the operation, maintenance, management, updating and upgrade or replacement of the PSERN System as authorized by law.

NOW THEREFORE, for and in consideration of the mutual promises set forth hereinafter and as provided for in the above-referenced recitals, which are made a part of this Ground Lease, the Parties do hereby agree:

Section 1. Land

1.1 Leased Land. Subject to the terms and conditions set forth below, SPU leases to Lessee and Lessee leases from SPU, a portion of the Property, situated in King County, Washington, consisting of a 104' x 77' area, approximately 8,008 square feet (“Leased Land”) for Lessee’s exclusive use for the construction, operation and maintenance of a communication facility, including but not limited to a tower and associated equipment, necessary utilities for the PSERN System’s facilities, a drainage field and improvements (the “Tower Facilities”), along with non-

exclusive routes for ingress, egress, access and electric utilities over, under and across the Property, as more particularly described and depicted in Exhibit B annexed hereto, to conduct the Authorized Activities set forth in Section 4 and for no other purpose.

The Leased Land is leased from SPU to Lessee in an “as is, with all faults” condition, without warranty and without regard to Lessee’s intended uses. Lessee acknowledges it has had the right and opportunity to inspect such Leased Land and that it relies on its own or its experts’ knowledge in regard to the Leased Land.

Section 2. Consideration

2.1 Rent. Lessee agrees to pay the following fees for the rights and privileges set forth in this Ground Lease:

a. The annual rental fee to be paid SPU for the use of said Leased Land shall be TWENTY THOUSAND DOLLARS (\$20,000.00), commencing on the first day of the month following the earlier of the date Lessee commences construction of the Tower Facilities or twenty-four (24) months after the Effective Date (“Rent Commencement Date”). From and after the Rent Commencement Date, all of the annual rental fee shall be paid in lawful money of the United States of America in advance of or on the first day of January for each year of the Term (defined in Section 3.4). If the commencement, expiration or termination of the Term does not coincide with the calendar year, then the annual rental fee for such partial year shall be prorated. Notwithstanding anything in this Ground Lease to the contrary, provided SPU receives the first rental fee within forty-five (45) days after the Rent Commencement Date, such rental fee shall not be deemed past due and Lessee shall not be deemed to be in Default (defined in Section 7.1) of this Ground Lease.

b. If Lessee fails to make payment on or before January 1st of each year during the Term, and such failure is not cured within ten (10) business days after Lessee’s receipt of written notice that such amount is past due, a late payment charge shall be assessed in the amount of FIVE HUNDRED DOLLARS (\$500.00). SPU shall notify Lessee of any assessment of late fees if rental fees are late. Late payment charges shall be paid within thirty (30) days of Lessee’s receipt of SPU’s written notice that a late fee has been assessed based on the late payment of the annual rental fee.

c. The Parties agree that they shall acknowledge in writing the Rent Commencement Date as follows: Lessee shall notify SPU in writing of the Rent Commencement Date and within ten (10) business days of receipt thereof, SPU shall acknowledge such date in writing as the Rent Commencement Date and return such signed written instrument to Lessee.

d. To assure proper posting of payments, Lessee shall note on its checks "SPU Ground Lease P.M. #T14-802." Annual rental fee payments shall be sent to:

Seattle Public Utilities
Accounts Receivable
PO Box 34018
Seattle WA 98124-4018

e. The rental fee will be subject to an annual escalation of one and one-half percent (1.5%), commencing on the first day of January after the first full year of the Term, and on each January first thereafter during the Term.

f. Lessee hereby acknowledges and agrees that, in the event of an increase of rental fee either pursuant to Section 2.1.e or mutually agreed upon in writing by the Parties, all other provisions of this Ground Lease shall remain in full force, changed only by such alterations in the amount of the rental fee and not otherwise.

2.2 SPU's Right to Utilize Lessee's Facilities. Provided the Parties first enter into a mutually acceptable sublease agreement, SPU shall have the right to attach its own facilities on, to and within Lessee's Tower Facilities and/or occupy space within the Leased Land; provided such use and operations do not unreasonably interfere with the operation and maintenance of Lessee's Tower Facilities and Lessee's use of the Leased Land by Lessee or any pre-existing tenants thereon; and provided further that the Tower Facilities are structurally capable of supporting SPU's facilities without exceeding radio frequency ("RF") emission limits and there is sufficient space on the Leased Land to accommodate SPU's facilities. SPU shall provide Lessee with a written notice of intent to enter into a sublease with Lessee for the uses provided in this Section, and Lessee shall provide a draft sublease agreement to SPU for such attachment or use of space within a reasonable period of time thereafter. SPU and Lessee shall both use commercially reasonable efforts to negotiate and enter into a mutually acceptable sublease agreement for SPU's proposed use.

2.3. Lessee's Obligation to Remove Lessee's Tower Facilities and Personal Property.

a. Except as otherwise provided in this Ground Lease, all portions of the Tower Facilities brought and/or erected onto the Property by Lessee, including the tower itself and its foundation, will be and remain Lessee's personal property during the Term of this Ground Lease ("Personal Property"). During the Term of this Ground Lease and upon termination, Lessee shall have the right to remove some or all of its Personal Property, whether or not attached to the Leased Land, provided that such may be removed without serious damage to the Property. All damage to the Property caused by removal of Lessee's Personal Property shall be promptly restored or repaired by Lessee.

b. Lessee specifically acknowledges that as part of the consideration required for this Ground Lease, Lessee shall remove its Personal Property, including the tower itself and its foundations, from the Property within forty-five (45) days after the expiration or earlier termination of this Ground Lease, or within one (1) year after any written notice of early termination given pursuant to the terms of this Ground Lease, whichever is later. Lessee acknowledges and agrees that Lessee is obligated to pay the rental fee to SPU for the Leased Land until such time as the Lessee's Personal Property has been removed from the Leased Land or ownership thereof has transferred to SPU, in accordance with Section 2.3(e).

c. Upon the expiration or earlier termination of this Ground Lease, to the extent that Lessee has failed to comply with its obligation to remove its Personal Property from the Property, as provided in this Section, SPU shall have the right, but not the obligation, to remove

and dispose of some or all of the Personal Property at Lessee's sole cost and expense; provided that Lessee need only reimburse SPU for its reasonable direct costs incurred to remove and dispose of the Personal Property.

d. Within forty-five (45) days after the expiration or earlier termination of this Ground Lease, or within one (1) year after any written notice of early termination given pursuant to the terms of this Ground Lease, whichever is later, Lessee shall at Lessee's sole cost and expense restore the Leased Land to the condition that existed prior to Lessee's occupancy, reasonable wear and tear excepted, including removal of the Personal Property in accordance with the terms of this Section, but excluding the replacement of trees or other landscaping that was removed during the construction process. To the extent that Lessee fails to restore the Leased Land to its original condition in accordance with this Section, and has failed to comply with this obligation within a reasonable period of time after receipt of written notice thereof, SPU shall have the right, but not the obligation, to restore the Leased Land, as provided for in this Section, at Lessee's sole cost and expense.

e. To the extent that Lessee fails to remove any of its Personal Property as provided in this Section, SPU shall have the right but not the obligation, and at its sole discretion, to take ownership of such property or a portion thereof "as is, with all faults" upon written notice to Lessee and at no cost to SPU.

2.4 Payment of Taxes. The Parties acknowledge there are no real estate taxes assessed against the Leased Land, but there may be a leasehold tax. Provided Lessee is not otherwise exempt, Lessee will pay .1284% annual leasehold tax, and any taxes that may be imposed on the leasehold interest of the Lessee in the future, on an annual basis, unless a different payment schedule is approved by SPU.

2.5 Payment of Electric Utility Consumption Charges. All charges for electricity consumption by the Lessee are included in the annual rental fee paid by Lessee to SPU.

2.6 Pro Rata Return for Termination. In the event that the rights granted by this Ground Lease are terminated prior to the expiration of the Term, Lessee shall be entitled to a refund or credit, whatever the case may be, of the pro rata share of any consideration paid to SPU and attributable to the unexpired Term of this Ground Lease; provided that Lessee shall remain obligated to pay the rental fee to SPU after the termination of this Ground Lease in accordance with the terms of Section 2.3 herein above.

2.7 Remaining in Possession/Holdover. In the event Lessee holds over on the Leased Land, in accordance with Section 3.3, provided the Parties are actively, in good faith, negotiating a new ground lease for Lessee's continued use of the Leased Land, Lessee shall continue to pay the rental fee in effect immediately prior to the expiration of this Ground Lease for such holdover period. In the event the Parties do not mutually agree on a new ground lease for Lessee's continued use of the Leased Land within six (6) months after the expiration of this Ground Lease, then Lessee shall pay on a monthly basis from that time going forward, as consideration for the continuing holdover, the equivalent of one hundred twenty-five percent (125%) of the equivalent monthly rental rate during the last month of the final Extension Term (defined in Section 3.2).

Section 3. Term

3.1 Initial Term. The initial term of this Ground Lease shall be twenty-five (25) years, commencing on the Rent Commencement Date and shall terminate on the twenty-fifth anniversary of the Rent Commencement Date, unless terminated sooner under the terms of this Ground Lease.

3.2 Extension Terms. Lessee shall have the right to extend the term of this Ground Lease for an additional three (3) periods of five (5) years each (each an "Extension Term"). Each Extension Term shall be exercised automatically, unless Lessee provides SPU written notice of its intent not to extend the term at least ninety (90) days prior to the expiration of the then-current initial term or Extension Term.

3.3 Holdover. In the event Lessee continues to utilize and occupy the Leased Land after the expiration of the initial term and all Extension Terms and such continued use is permitted by SPU, the Term of this Ground Lease shall convert to a month-to-month tenancy, terminable by either Party on thirty (30) days written notice. During such holdover term both Parties shall continue to remain bound and subject to all the terms and provisions of this Ground Lease.

3.4 Term. The initial twenty-five (25) year term, the Extension Terms and any holdover term whereby Lessee remains in possession of the Leased Land and continues operations of the Tower Facilities thereon, may be collectively referred to herein as the "Term."

Section 4. Lessee's Authorized Activities

4.1 Authorized Activities. Lessee's use of the Leased Land shall only be for the construction, installation, operation, maintenance, repair, replacement, modification, upgrade, update and removal of the Tower Facilities for the PSERN System as it is presently designed or may hereinafter be modified or changed, as well as the right to access the Leased Land across the Property from a public right-of-way, and the right to install one electric service line to the Leased Land from existing SPU electric facilities located on the Property, for a communications system to be used primarily for government use, including emergency services, public safety and other governmental purposes. Private uses of the Leased Land are not permitted without SPU's prior written consent. Lessee's proposed use of the Leased Land is subject to plan review and approval by SPU. From and after the date Lessee's plans have been approved by SPU, the use depicted thereon shall be referred to herein as the "Authorized Activities". No other activities may be conducted on the Leased Land without the prior written permission of SPU. Lessee shall have the continuing obligation to keep its Tower Facilities in a structurally safe, secure, and good working order. Lessee shall remove any antennae, dishes, cables, and related appurtenances that are no longer actively being used, or being maintained for contingent purposes. Not included in this Ground Lease are any rights to harvest, collect, or damage any natural resource, including aquatic life or living plants, unless required to facilitate Lessee's Authorized Activities on the Leased Land.

4.2 Compliance with Laws. Lessee shall, at all times, keep current and comply with all conditions and terms of any permits, licenses, certificates, regulations, ordinances, statutes, and

other government rules and regulations regarding the use of the Leased Land, including any authorized use of Hazardous Substances (defined in Section 4.4.d.) by Lessee. Lessee shall, at its sole expense, obtain all regulatory or proprietary consents or approvals required to be obtained from any federal, state or local entity in connection with the Authorized Activities on the Leased Land or Lessee's use and/or occupation of the Leased Land (collectively referred to hereinafter as "Government Approvals").

4.3 No Unlawful Use. Lessee shall not use or permit the Leased Land or any part thereof to be used for any purpose in violation of any municipal, county, state or federal law, ordinance or regulation. Lessee shall promptly comply, at its sole cost and expense, with all laws, ordinances and regulations now in force or hereafter adopted (but only if such newly adopted law, ordinance or regulation requires pre-existing uses to come into compliance therewith), relating to or affecting the condition, use or occupancy of the Leased Land.

4.4 No Hazardous Substances.

a. SPU is not aware of any Hazardous Substances (defined in Section 4.4.d) located on the Property in the soil, groundwater, or other environmental media, in violation of applicable laws. Lessee and SPU agree that they will not place, dispose of or store any Hazardous Substance on the Property in violation of applicable laws. The Parties acknowledge that, consistent with this Section, Lessee may be installing on the Property backup power devices such as batteries in quantities normal and customary for such use.

b. In addition to and without limiting the obligation under Section 8.2, Lessee shall indemnify, defend and hold harmless SPU with respect to any and all Claims (defined in Section 8.2) arising from the release of any Hazardous Substances on the Property caused by Lessee, its employees or agents, except to the extent that such Claims are caused by SPU, its employees or agents, another tenant, its employees or agents, or a third-party.

c. Without limiting the Lessee's obligation under Section 8.2, SPU shall indemnify, defend and hold harmless Lessee with respect to any and all Claims arising from the presence or release of any Hazardous Substances on the Property caused by SPU or its employees or agents, except to the extent that such Claims are caused by Lessee, its employees or agents. In addition, SPU hereby agrees to indemnify and hold harmless Lessee with respect to any and all Claims arising from the presence of any Hazardous Substances on the Property as of the Effective Date; provided that such Claims do not arise from, and are not otherwise exacerbated by, any of Lessee's actions or work on the Property.

d. For purposes of this Ground Lease, "Hazardous Substances" shall mean any substance subject to regulation under the Washington Hazardous Waste Management Act (Ch. 70.105 RCW) and implementing regulations, any "hazardous substance" under the Washington Model Toxics Control Act (Ch. 70.105D RCW) and implementing regulations, and any "hazardous substance" or "hazardous waste" as defined by the Comprehensive Environmental Response, Compensation and Liability Act of 1980 (42 USC §§ 9602 et seq.) and implementing regulations, as these laws are amended from time to time; underground storage tanks, whether empty, filled or partially filled with any substance; asbestos; urea formaldehyde foam insulation; PCBs; and any other substance, waste, material or chemical deemed or defined as hazardous,

toxic, a pollutant, contaminant, dangerous or potentially dangerous, noxious, flammable, explosive, or radioactive, the removal of which is required or the manufacture, preparation, production, generation, use, maintenance, treatment, storage, transfer, handling, or shipment of which is restricted, prohibited, regulated or penalized by any federal, state, county, municipal or other local governmental statute, regulation, ordinance or resolution as these laws are amended from time to time.

4.5 Lessee's Restrictions on Use. Lessee shall not cause or permit any damage to natural resources on the Leased Land, except as contemplated by the Authorized Activities. Lessee shall also not cause or permit any filling activity to occur on the Leased Land. This prohibition includes any deposit of rock, earth, ballast, refuse, garbage, waste matter (including chemical, biological or toxic wastes), hydrocarbons, any other pollutants, or other matter in or on the Leased Land, except as approved in writing by SPU. Lessee shall neither commit nor allow waste to be committed to or on the Leased Land. If Lessee fails to comply with all or any of the restrictions in use set out in this Section 4.5, SPU may take any steps reasonably necessary to remedy such failure. Upon demand by SPU, Lessee shall pay all costs of such remedial action, including but not limited to the costs of removing and disposing of any material deposited improperly on the Leased Land.

4.6 Due Diligence. For a period of thirty (30) days beginning from the Effective Date of this Ground Lease, Lessee shall have the right to obtain a title report or commitment for a leasehold title policy from a title insurance company of its choice and to have the Property surveyed by a surveyor of its choice. Lessee may also perform and obtain during this thirty (30) day period, at Lessee's sole cost and expense, soil borings, percolation tests, engineering procedures, environmental investigation or other tests or reports on, over, and under the Property, necessary to determine if Lessee's use of the Leased Land will be compatible with Lessee's engineering specifications, system, design, operations or Government Approvals. In the event that Lessee determines that the Leased Land is incompatible for Lessee's Authorized Activities, Lessee may terminate this Ground Lease upon written notice to SPU within this thirty (30) day period.

4.7 Access and Utilities.

a. As part of the consideration for this Ground Lease, SPU hereby grants Lessee non-exclusive access routes on, over, under and across the areas designated in Exhibit B for ingress and egress, between the public right of way and the Leased Land, along the Tolt Pipeline Road, adequate to construct, install, operate, maintain, repair, replace, upgrade, update, and remove the Tower Facilities, and to service the Leased Land at all times during the Term of this Ground Lease. The right to use the access route provided hereunder shall have the same Term as this Ground Lease, commencing upon the Effective Date; provided that Lessee shall retain its access rights across the Property to and from the Leased Land after the effective expiration or termination date for the sole purpose of compliance with the removal and restoration terms of this Ground Lease. Such access route is provided in an "as is" condition, without warranty and without regard to Lessee's intended uses. Lessee acknowledges it has had the right and opportunity to inspect the access route identified in Exhibit B and that it relies on its own or its experts' knowledge in regard to such access rights.

b. Lessee shall have the right to access the Leased Land, seven (7) days a week, twenty-four (24) hours a day, on foot, motor vehicle, including trucks, or by air over or along the access route depicted in Exhibit B.

c. Lessee shall have the right to construct a fence, lighting, cameras or alarm systems to secure the Leased Land. SPU shall not allow the placement, construction, or installation of any equipment or materials in the Leased Land without Lessee's prior written consent, which consent may not be unreasonably withheld, conditioned or delayed.

d. Intentionally omitted.

e. Lessee shall have the right to construct and maintain, at Lessee's expense, an underground electric utility conduit and supporting utility facilities, for electric power delivery to the Leased Land, the locations for which are generally depicted in Exhibit B. The design and construction of such electric service facilities shall be subject to SPU's written consent, which shall not be unreasonably withheld, conditioned or delayed. Both Parties acknowledge and agree that Lessee's annual rental fee includes Lessee's submetered electricity usage.

f. SPU agrees to provide Lessee at least twenty-four (24) hours advance written notice of any planned interruptions of electrical service that Lessee is submetering from existing electrical utilities located on the Property; provided SPU has actual knowledge of such planned interruption. SPU acknowledges that Lessee provides emergency communication services that require electrical power to operate and must operate twenty-four (24) hours per day, seven (7) days per week. SPU will not be responsible for interference with, interruption of or failure, beyond the reasonable control of SPU, of such services to be furnished or supplied by SPU facilities.

Section 5. SPU's Retained Rights and Continuing Operations

5.1 SPU's Retained Rights Continuing Operations. SPU reserves for itself, its officials, agents, contractors, employees, successors and assigns the right to construct, operate, test, repair and maintain existing and additional overhead and/or underground transmission and/or distribution and/or service lines, together with but not limited to, the facilities which are necessary and convenient for utility purposes on the Leased Land ("SPU Facilities"); provided such construction, operation, testing, repair and maintenance of the SPU Facilities does not unreasonably interfere with Lessee's physical use of the Leased Land or physical operation of the Tower Facilities thereon.

5.2 SPU Access and Right to Exclude. SPU shall maintain the right to access all areas of the Leased Land, including access and utility routes permitted herein, as necessary and convenient for its utility purposes. SPU's rights shall include the right to exclude Lessee, and Lessee's officials, employees, agents, consultants, contractors, representatives, licensees, invitees, or visitors from certain areas of the Property (not including the Leased Land) and the access route, as necessary and convenient for utility purposes. In the event SPU exercises its right to exclude, (a) SPU shall use commercially reasonable efforts to cooperate with Lessee to obtain access to the Leased Land from a public right-of-way, at no cost to SPU; and (b) SPU shall endeavor to give Lessee as much advanced written notice as is reasonably possible, but in

no event less than twenty-four (24) hours advance written notice; provided that in the case of emergencies, SPU shall be relieved of any prior written notice requirements, but shall give Lessee written notice of such access as soon as reasonably possible thereafter.

5.3 Intentionally omitted.

Section 6. Eminent Domain

6.1 Taking. If all of the Leased Land is taken by Eminent Domain (defined below), this Ground Lease shall terminate as of the date Lessee is required to vacate the Leased Land and all rental fees and any other additional fees owing shall be paid to that date; any unearned prorated portion of the pre-paid fees (including but not limited to rental fees) shall be returned to Lessee prior to the effective date of such taking. The term "Eminent Domain" shall include the taking or damaging of property by, through or under any governmental or statutory authority, and any purchase or acquisition in lieu thereof, whether the damaging or taking is by government or any other person. If a taking of any part of the Leased Land by Eminent Domain renders the remainder thereof unusable by Lessee, the Ground Lease may, at the option of Lessee, be terminated by written notice given to SPU not more than sixty (60) days after Lessee's receipt of written notice of the taking, and such termination shall be effective as of the date when Lessee is required to vacate the portion of the Leased Land so taken. Whenever any portion of the Leased Land is taken by Eminent Domain and this Ground Lease is not terminated, rental fees hereunder shall be reduced from the date Lessee is required to partially vacate the Leased Land in the same proportion that the Leased Land taken bears to the total Leased Land prior to taking.

6.2 Award.

a. SPU reserves all rights to the entire damage award or payment for any taking by Eminent Domain, and Lessee waives all claims for damages for termination of its leasehold interest in the Leased Land or for interference with its business. Lessee hereby grants and assigns to SPU any right Lessee may now have or hereafter acquires to such damage award, excluding such damages Lessee has a right to under Section 6.2.b herein below.

b. Notwithstanding anything herein to the contrary, Lessee shall have the right to claim from the condemning authority all compensation that may be recoverable by Lessee on account of any loss incurred by Lessee for business interruption and in removal or relocation of Lessee's structures and equipment on and from the Property; provided, however, that Lessee may claim such damages only if they are awarded separately in the Eminent Domain proceeding and not out of or as part of SPU's damages.

Section 7. Default

7.1 Definition.

a. If either Party violates or breaches or fails to keep or perform any covenant, term or condition of this Ground Lease, or if Lessee is adjudicated insolvent, such Party shall be deemed in default hereunder ("Default"). If a Default continues for or is not remedied within forty-five (45) days after written notice thereof has been given by the non-defaulting Party to the

defaulting Party specifying the Default, then the non-defaulting Party shall have the right, at its option, in addition to and not exclusive of any other remedy the non-defaulting Party may have under this Ground Lease or by operation of law, to terminate this Ground Lease upon written notice to the defaulting Party; provided that, if the Default cannot reasonably be cured within such forty-five (45) day period, and the defaulting Party has commenced to cure such Default within such forty-five (45) day period and such efforts are prosecuted to completion with reasonable diligence, then the non-defaulting Party shall not exercise its right to terminate this Ground Lease. In the event of termination pursuant to this Section, Lessee shall only be responsible for the rental fee until the date all Personal Property has been removed from the Leased Land, or ownership thereof has transferred to SPU, in accordance with the terms of Section 2.3 herein above.

b. In the event that Lessee is in Default of this Ground Lease beyond any applicable cure period, SPU shall have the following nonexclusive rights and remedies in addition to those set forth in Section 7.1.a, at its option: (i) to terminate this Lease and, provided Lessee is not in compliance with the terms of Section 2.3, reenter the Leased Land, take possession thereof, and remove all persons and property therefrom, for which actions Lessee shall have no claim thereon or hereunder; or (ii) subject to the terms of Section 13, to cure such Default on Lessee's behalf and at Lessee's sole expense, and to charge Lessee for all reasonable direct costs and expenses incurred by SPU in effecting such cure, including but not limited to attorneys' fees and costs.

c. In the event that SPU is in Default of this Ground Lease beyond any applicable cure period, Lessee shall have the right, in addition to those rights and remedies set forth in Section 7.1.a, at its option to cure such Default on SPU's behalf and at SPU's sole expense. In such event, within forty-five (45) days after SPU's receipt of an invoice setting forth Lessee's expenses incurred to cure SPU's Default, SPU shall repay Lessee the amount therein.

7.2 Reentry. If SPU terminates this Ground Lease and reenters the Leased Land under option (i) of Section 7.1.b, to obtain possession of the Leased Land and exclude Lessee from use thereof, Lessee shall be liable for and shall reimburse SPU upon demand for all reasonable costs and expenses incurred in retaking possession of the Leased Land and all other losses suffered by SPU as a consequence of Lessee's Default. In the event of any entry or taking possession of the Leased Land, SPU shall have the right, but not the obligation, to remove therefrom all or any part of the Personal Property, as defined in Section 2.3, located therein and may place the same in storage at a public warehouse at the expense and risk of Lessee.

7.3 Termination. If SPU elects to terminate this Ground Lease pursuant to the provisions of Section 7.1.a, Lessee shall be liable to SPU for any amount necessary to compensate SPU for all the detriment caused by Lessee's failure to perform its obligations under this Ground Lease, including but not limited to, any reasonable direct costs or expenses incurred by SPU in retaking possession of the Leased Land, including reasonable attorneys' fees therefore; repairing the Leased Land after such Default; returning the Leased Land to its condition prior to the Rent Commencement Date of this Ground Lease, including repairs or alterations to the Leased Land for such return; and any other reasonable costs directly necessitated by such Default.

7.4 Consequential Damages. Notwithstanding anything in this Ground Lease to the contrary, under no circumstances shall the defaulting Party be liable to the non-defaulting Party

for consequential, incidental or punitive damages that result from a Default, including, but not limited to, rental fees that would have accrued after the date all Personal Property has been removed from the Leased Land, or ownership thereof has transferred to SPU, in accordance with the terms of Section 2.3, costs incurred to re-let the Leased Land, and such other amounts in addition to or in lieu of the foregoing as may be permitted from time to time by the laws of the State of Washington.

Section 8. Release and Indemnification

8.1 Release. SPU makes no covenant, representation, or warranty to the Lessee that any pre-existing or subsequent user of the Property will not cause interference with or interruption of the Lessee's use of the Tower Facilities or the Leased Land. So long as SPU complies with its obligations under Section 28 and takes reasonable steps to cause any third-party users to comply with the requirements under Section 28, Lessee hereby releases SPU from any Claims arising from interference with Lessee's permitted use of the Leased Land for its Tower Facilities caused by third parties, except to the extent caused by SPU's negligence or willful misconduct.

8.2 Mutual Indemnification. As used in this Ground Lease, "Claims" means all claims, lawsuits, losses, damages, costs (including but not limited to reasonable attorney's fees), expenses and liabilities of any kind arising from damage to property or bodily injury, including death. The Lessee shall defend, indemnify and hold harmless SPU and its directors, officers, elected officials, employees, and contractors from and against any and all Claims to the extent caused by the Lessee's breach of this Ground Lease or the negligent acts or omissions of the Lessee, or its employees, elected officials, servants, contractors, licensees or invitees. SPU shall defend, indemnify and hold harmless the Lessee and its directors, officers, elected officials, employees, and contractors from and against any and all Claims to the extent caused by SPU's breach of this Ground Lease or the negligent acts or omissions of SPU, or its employees, elected officials, servants, contractors, licensees or invitees.

8.3 Waiver of Immunity under Title 51. Each Party agrees that the foregoing indemnity specifically covers actions brought by its own employees and that this indemnity shall survive termination or expiration of this Ground Lease. The foregoing indemnity is specifically and expressly intended to constitute a waiver of each Party's immunity under Washington's Industrial Insurance Act, Revised Code of Washington ("RCW") Title 51, but only with respect to the other and to the extent necessary to provide a full and complete indemnity from Claims as required under Section 8.2. Each Party shall promptly notify the other of casualties or accidents occurring in or about the Property.

Section 9. Insurance

9.1 Lessee's Insurance Coverages and Limits. Lessee shall, at its sole cost and expense, maintain, and cause its subtenant(s), if any, to maintain in full force and effect the following minimum limits of insurance or self-insurance, and adhere to all terms and conditions set forth below, throughout the entire Term:

a. **Commercial General Liability ("CGL")** written on an occurrence form at least as broad as ISO CG 00 01, with minimum limits of liability:

\$1,000,000 per Occurrence
\$2,000,000 General Aggregate
\$2,000,000 Products/Completed Operations Aggregate
\$1,000,000 Personal/Advertising Injury Liability
\$1,000,000 Damage to Premises Rented to You

Employers Liability / Washington Stop Gap

\$1,000,000 Each Accident / Each Disease / Policy Limit

Alternatively, coverage may be evidenced as Employer's Liability insurance under Part B of a Workers Compensation insurance policy.

CGL Coverage shall include: Premises and Operations; Broad Form Property Damage (Including Completed Operations); Liability assumed under an Insured Contract, subject to standard policy exclusions (including tort liability of another assumed in a business contract); Personal Injury and Advertising Liability; Independent Contractors; Severability of Interest Clause; Waiver of Subrogation endorsement in favor of Owner as required by contract; "Claims Made" and "Modified Occurrence" policy forms are not acceptable.

The limits of liability described above are minimum limits of liability only. Regardless of provisions to the contrary under the terms of any insurance policy maintained by Lessee, the specification of any such minimum limits shall neither be (1) intended to establish a maximum limit of liability to be maintained by Lessee regarding this Ground Lease, nor (2) construed as limiting the liability of any of Lessee's insurers, which must continue to be governed by the stated limits of liability of the relevant insurance policies.

b. **Automobile Liability** insurance at least as broad as ISO CA 00 01 including coverage for owned, non-owned, leased or hired vehicles, as applicable, with a minimum limit of \$1,000,000 each accident for bodily injury and property damage.

c. **Workers' Compensation** insurance, or qualified self-insurance, securing Lessee's liability for industrial injury to its employees in accordance with the provisions of Title 51 of the RCW.

d. **Umbrella or Excess Liability** insurance if and as necessary to maintain total CGL and Automobile Liability insurance limits of \$5,000,000 each occurrence and be no less broad than coverages described above.

e. **Property** insurance under which the Lessee's Tower Facilities and all alterations, additions and improvements that Lessee makes to the Leased Land are insured throughout the Term in an amount not less than the replacement cost new thereof, against the following hazards: (i) loss from the perils of fire and other risks of direct physical loss (earthquake optional), not less broad than provided by the insurance industry standard "Causes of Loss - Special Form" (ISO form CP 1030 or equivalent); (ii) loss or damage from water leakage or sprinkler systems now or hereafter installed in or on the Leased Land; (iii) loss or damage by explosion of steam boilers, pressure vessels, or above-ground oil or gasoline storage tanks or similar apparatus now

or hereafter installed on the Leased Land; and (iv) loss from business interruption or extra expense, with sufficient coverage to provide for the payment of the annual rental fee and other costs during any interruption of Lessee's business. SPU shall be named as an additional loss payee, as its interest may appear, as respects property insurance covering the alterations, additions and improvements under such policy.

f. In the event that SPU deems insurance to be inadequate to protect Lessee and SPU, Lessee shall reasonably increase coverages and/or liability limits as SPU shall deem reasonably adequate within sixty (60) days after the date of written notice.

9.2 Terms and Conditions for Lessee's Insurance.

a. **SPU as Additional Insured.** The CGL insurance and, in addition, excess and/or umbrella liability insurance, if any, shall include "SPU, its officers, officials, employees, agents and volunteers" as additional insureds. Lessee's insurance shall be primary and non-contributory to any insurance maintained by or available to SPU. If the Lessee's self-insurance program does not allow for additional insureds, this paragraph does not apply.

b. **Required Separation of Insured Provision; Cross-Liability Exclusion and other Endorsements Prohibited.** Lessee's CGL insurance policy shall include a "separation of insureds" or "severability" clause that applies coverage separately to each insured and additional insured, except with respect to the limits of the insurer's liability. Lessee's CGL insurance policy shall not contain any provision, exclusion or endorsement that limits, bars, or effectively precludes SPU from coverage or asserting a claim under the Lessee's CGL insurance policy on the basis that the coverage or claim is brought by an insured or additional insured against an insured or additional insured under the policy.

c. **Cancellation Notice.** Coverage shall not be cancelled without forty-five (45) days written notice of such cancellation, except ten (10) days written notice as respects cancellation for non-payment of premium, to SPU at its notice address set forth in Section 14 below, except as may otherwise be specified in RCW 48.18.290 (Cancellation by insurer). SPU and the Lessee mutually agree that for the purpose of RCW 48.18.290(1)(a), for both liability and property insurance, SPU is deemed to be a "mortgagee, pledge, or other person shown by (the required insurance policies) to have an interest in any loss which may occur thereunder."

d. **Minimum Security Requirements.** Each insurance policy required hereunder shall be: (1) subject to reasonable approval by SPU that it conforms with the requirements of this Section, and (2) be issued by an insurer rated A-:VIII or higher in the then-current A. M. Best's Key Rating Guide and licensed to do business in the State of Washington unless procured under the provisions of Chapter 48.15 RCW (Unauthorized insurers).

e. **Deductible or Self-Insured Retention.** Any deductible or self-insured retention ("S.I.R.") must be disclosed to, and shall be subject to reasonable approval by, SPU. Lessee shall cooperate to provide such information as SPU may reasonably deem to be necessary to assess the risk bearing capacity of the Lessee to sustain such deductible or S.I.R. The cost of any claim falling within a deductible or S.I.R. shall be the responsibility of Lessee. If a deductible or S.I.R. for CGL or equivalent insurance is not "fronted" by an insurer but is funded and/or administered by Lessee or a contracted third-party claims administrator, Lessee agrees to defend and

indemnify SPU to the same extent as SPU would be protected as an additional insured for primary and non-contributory limits of liability as required herein by an insurer.

9.3 Property Insurance Coverage and Limits. During such time as Lessee is engaged in the performance of the initial installation or other structural renovation of the Property, the Lessee or its contractor(s) shall maintain in full force and effect “All Risks” builder’s risk property insurance or reasonable equivalent for the portion of the Property under structural renovation, including fire and flood, on a replacement cost new basis. In the event of a Claim under the builder’s risk policy, Lessee or its contractor(s) shall be responsible for paying any deductible under the policy if Lessee or any of its agents, employees, or contractors is responsible for the loss or damage. It shall be Lessee’s responsibility to properly coordinate with SPU’s Risk Management Division the placement of builder’s risk property insurance prior to any new construction on, or structural alteration of, the Property.

9.4 Waiver of Subrogation. Unless such waiver would void the property insurance coverage to be provided pursuant to this Section 9, SPU and Lessee waive all subrogation rights each may have against the other, or any subtenant, for damages caused by fire or other perils to the extent covered by property insurance obtained pursuant to this Section 9 or other property insurance applicable to the Property or other structures within the Tolt Water Corridor, except such rights as they have, to proceeds of such insurance held by SPU or the Lessee or both as fiduciary. This waiver of subrogation shall be effective to a person or entity even though that person or entity would otherwise have a duty of indemnification, contractual or otherwise, whether or not the person or entity paid the insurance premium directly or indirectly, and whether or not the person or entity has an insurable interest in the property damaged.

9.5 Evidence of Insurance. On or before the Rent Commencement Date, and thereafter not later than the last business day prior to the expiration date of each such policy, the following documents must be delivered to SPU at its notice address set forth in Section 14 below as evidence of the insurance coverage required to be maintained by Lessee:

a. Certification of insurance documenting compliance with the coverage, minimum limits and general requirements specified herein;

b. A copy of the policy’s declarations pages, showing the insuring company, policy effective dates, limits of liability, and the “Schedule of Forms and Endorsements” specifying all endorsements listed on the policy including any company-specific or manuscript endorsements;

c. A copy of the CGL insurance policy endorsements expressly including SPU and its officers, elected officials, employees, agents and volunteers as additional insureds (whether on ISO Form CG 20 26 or an equivalent additional insured or blanket additional insured policy wording), showing the policy number;

d. Pending receipt of the documentation specified in this Section 9.5, Lessee may provide a copy of a current complete binder. An ACORD certificate of insurance will not be accepted in lieu thereof; and

e. Evidence of insurance as set forth above, shall be issued to SPU, at SPU's notice address set forth in Section 14 below.

f. In lieu of the above documents, Lessee may provide SPU with a letter of self-insurance as adequate proof of coverage. Lessee is required to update such proof only upon substantial changes to its self-insurance program; provided that if the Lessee assigns this Ground Lease as permitted under Section 10, the Lessee or its assignee shall provide proof of coverage in compliance with the requirements of this Section 9 prior to or upon the effective date of the assignment.

9.6 Assumption of Property Risk. The placement and storage of Lessee's Tower Facilities in or about the Leased Land shall be the responsibility, and at the sole risk, of Lessee.

9.7 Adjustments of Claims. The Lessee shall provide for the prompt and efficient handling of all Claims for bodily injury, property damage or theft to the extent arising out of, and subject to the terms of Section 9.4, Waiver of Subrogation, the activities of the Lessee under this Ground Lease.

9.8 Lessee's Responsibility. The procuring of the policies of insurance required by this Ground Lease shall not be construed to limit the Lessee's liability hereunder. Notwithstanding said insurance, and subject to the terms of Section 9.4, Waiver of Subrogation, the Lessee shall be obligated for the full and total amount of any damage, injury or loss caused by the negligence of the Lessee, or any of its agents, officers and employees or through Lessee's use or occupancy of the Property.

9.9 Third-Party Insurance. Before authorizing any contractor or third-party to enter onto the Property to perform any activity on behalf of the Lessee, the Lessee shall be responsible for ensuring that all such parties are insured in the forms described in Section 9.5, Evidence of Insurance, herein above and meet all requirements in Sections 9.1.a, b, c, f, 9.2, 9.5, 9.6, 9.7, and 9.8.

9.10 The Lessee maintains a fully funded self-insurance program for the protection and handling of its liabilities including injuries to persons and damage to property. SPU acknowledges, agrees and understands that the Lessee is self-funded for all of its liability exposures for this Ground Lease. The Lessee agrees to provide SPU with at least thirty (30) days prior written notice of any material change in the Lessee's self-funded insurance program. SPU further acknowledges, agrees and understands that the Lessee does not purchase CGL insurance and is a self-insured governmental entity; therefore, the Lessee does not have the ability to name SPU as an additional insured.

Section 10. Assignment

Lessee shall not assign this Ground Lease without express written permission of SPU, which shall be at SPU's sole discretion. SPU acknowledges that Lessee and other municipalities participating in the PSERN System intend to establish a new governmental non-profit entity that will eventually own and operate the PSERN System ("PSERN Operator"). Notwithstanding anything in this Ground Lease to the contrary, Lessee may assign its interest in this Ground Lease, without SPU's consent, to the PSERN Operator, provided that such PSERN Operator is a

governmental agency and such agency agrees to assume in writing all of the rights, obligations and conditions of this Ground Lease without change. Once this Ground Lease has been assigned to the PSERN Operator, no further assignment of this Ground Lease shall be permitted without the express written permission of SPU, which shall be at SPU's sole discretion. In the event of an assignment in accordance with the terms herein, the assignor will be relieved of all future performance, liabilities and obligations under this Ground Lease to the extent of such assignment.

Section 11. No Liens or Encumbrances

Lessee acknowledges and agrees that it will not pledge or use in any fashion the rights and privileges granted herein as security for any purpose. Lessee further acknowledges and agrees not to permit any liens or encumbrances from any source or for any purpose whatsoever arising out of Lessee's use of the Leased Land to attach to the Property; provided however that SPU agrees to sign a short form memorandum of this Ground Lease that Lessee may record at Lessee's expense.

Section 12. Insolvency

In the event that Lessee becomes insolvent, voluntarily or involuntarily bankrupt, or if a receiver, assignee or other liquidating officer is appointed for the business of the Lessee, and such receiver, assignee or other liquidating offer is not discharged within thirty (30) days from the date of his appointment, then SPU may terminate this Ground Lease at its option.

Section 13. SPU May Perform

a. If the Lessee breaches or fails to do any covenant, act or thing required to be done by the Lessee under this Ground Lease, except to pay rental fees, SPU may notify the Lessee of such failure, and give Lessee forty-five (45) days to correct such breach or perform such act or thing. In the event Lessee fails to perform within said forty-five (45) days, SPU shall have the right, at its sole option, but not the obligation, to do such act or thing on behalf of the Lessee, and within forty-five (45) days after Lessee's receipt of an invoice from SPU, including reasonably acceptable documentation supporting SPU's reasonable expenditure in connection therewith, the Lessee shall repay SPU the amount thereof. All such monies due shall be subject to interest at the rate of twelve percent (12%), or the maximum amount permitted at law, whichever is less, per annum, from the date that is forty-five (45) days after Lessee's receipt of SPU's invoice for said expenditure to the date of the Lessee's repayment.

b. Except as expressly set forth in this Ground Lease, SPU shall not maintain, repair or otherwise touch or interfere with Lessee's Tower Facilities without Lessee's prior consent; provided that, in the event of an emergency posing an imminent threat of bodily injury or property damage, SPU may take action necessary to abate the threat and shall give Lessee written notice of such actions taken as soon as is reasonably possible thereafter.

Section 14. Notices

Any notice, consent, request, or other communication provided for in this Ground Lease shall be in writing and shall be sent by registered or certified mail to the addresses listed below, unless a different address shall be designated in writing and delivered to the other Party.

If to SPU: Seattle Public Utilities
Facilities & Real Property
Seattle Municipal Tower, Suite 4900
700 5th Avenue
Seattle WA 98104

With a copy to: Seattle Public Utilities
Facilities & Real Property
PO Box 34018
Seattle WA 98124-4018

If to Lessee: King County Facilities Management Division
Real Estate Services
Attention: Leasing Supervisor
Re: Swan PSERN Lease
500 Fourth Avenue, Suite 830
Seattle, WA 98104

With a copy to: King County Facilities Management Division
Director's Office
Attention: Gail Houser
RE: Swan PSERN Lease
500 Fourth Avenue, Suite 800
Seattle, WA 98104

With a copy to: King County
Emergency Radio Communications Division - KCIT
Attention: Marlin Blizinsky
RE: Swan PSERN Lease
401 Fifth Avenue, Suite 600
Seattle, WA 98104

Notices shall be deemed to have been given when properly sent and received, refused or returned undelivered. Either Party may change their notice addresses set forth herein by giving the other Party thirty (30) days written notice thereof.

Section 15. Applicable Law and Venue

This Ground Lease shall be interpreted and construed pursuant to the laws of the State of Washington. Venue for any action arising out of or in connection with this Ground Lease shall be with King County Superior Court at Seattle.

Section 16. Intentionally omitted.

Section 17. Representation or Warranty

a. SPU makes no representations or warranties, and shall not in any way be liable for or, with respect to the condition of the Leased Land, or the Leased Land's suitability for Lessee's intended use, or for any use whatsoever and Lessee assumes the responsibility and risks of all defects and conditions in the Leased Land and surrounding areas, if any, that cannot be observed by casual inspection. Lessee acknowledges that Lessee has had the opportunity to inspect the Leased Land and Lessee will be relying entirely upon its own inspection and/or on any consultant Lessee may retain.

b. The Parties warrant that the officers and individuals executing below have been duly authorized to act for and on behalf of the Party for purposes of executing this Ground Lease and granting use of the access and utility routes set forth herein.

c. SPU represents, warrants and agrees that SPU's execution and performance of this Ground Lease will not violate any laws, covenants or the provisions of any mortgage, lease or other agreement binding on SPU.

Section 18. Quiet Enjoyment

Lessee understands and specifically acknowledges that this Ground Lease does not provide the normal quiet enjoyment provisions typical of other leases. If Lessee fully complies with and promptly performs all of the terms, covenants and conditions of this Ground Lease on its part to be performed, it shall have the right of quiet and peaceful use, possession and enjoyment of the Leased Land throughout the Term, subject, however, to SPU's retained rights and ongoing operations specifically set out in Section 5 herein above.

Section 19. Severability

In case any one or more of the provisions contained in this Ground Lease shall for any reason be held to be invalid, illegal, or unenforceable in any respect, such invalidity, illegality or unenforceability shall not affect any other provision hereof, and this Ground Lease shall be construed as if such invalid, illegal or unenforceable provision had never been contained herein.

Section 20. No Waiver

No waiver of any right under this Ground Lease shall be effective unless contained in a writing signed by an authorized representative of the Party sought to be charged with the waiver, and no waiver of any right arising from any breach shall be deemed to be a waiver of any future right or any other right arising under this Ground Lease.

Section 21. Force Majeure

Neither Party shall be deemed in Default hereof nor liable for damages arising from its failure to perform its duties or obligations hereunder, if such is due to any cause beyond its reasonable control, including, but not limited to an act of nature, act of civil or military authority,

fire, flood, windstorm, earthquake, strike or labor disturbance, civil commotion, delay in transportation, governmental delay, or war.

Section 22. Time

Time is of the essence of this Ground Lease.

Section 23. Other General Terms and Conditions

23.1 The Lessee shall assume all liability for any damage caused to SPU Facilities arising out of or resulting from Lessee's use of the Leased Land.

23.2 The Lessee agrees to submit plans furnishing details of any blacktopping, grading, cuts or fills on any part of the Property, for approval by the General Manager & Chief Executive Officer of SPU, or his or her authorized representatives, prior to the undertaking of any such blacktopping, grading, cuts or fills on the Property. Such approval will not be unreasonably withheld, conditioned or delayed.

23.3 After the initial installation of the Tower Facilities, Lessee shall obtain SPU's written consent prior to making any material changes to the Tower Facilities and the electric utility servicing the Tower Facilities that require a local governmental land use or building permit, which consent shall not be unreasonably withheld, delayed or conditioned. Except as provided herein above, after the initial installation of the Tower Facilities, SPU's consent shall not be required for any installation, maintenance, repair, replacement, addition, removal, update or upgrade of any of the Tower Facilities or the Leased Land, so long as it does not interfere with the then-current use of the Property by SPU.

23.4 SPU's execution of this Ground Lease will signify SPU's written approval of the site plans attached to this Ground Lease as Exhibit B, and will signify SPU's written approval of the Tower Facilities described in such site plans, including but not limited to Lessee's utility facilities, backup power batteries, generator(s) and fuel storage tank(s) depicted, listed or referenced thereon.

23.5 In all cases under this Ground Lease where SPU's prior written consent is required for any improvements to the Leased Land and/or the Tower Facilities, Lessee shall submit its written request for approval thereof to SPU, including proposed site plans therefor. If the General Manager & Chief Executive Officer of SPU, or his or her authorized representatives, fails to respond in writing to Lessee's proposed plans within thirty (30) days of their receipt, the plans will be deemed approved. After approval (or deemed approval), the plans will be considered incorporated into this Ground Lease as Exhibit C. If there is any discrepancy between the plans attached at Exhibit B and those of Exhibit C, the site plans approved (or deemed approved) by SPU last in time shall control. If SPU disapproves the plans, then Lessee will provide SPU with revised plans. In the event SPU disapproves the revised plans, Lessee may either: i) make further revisions to the plans and submit them to SPU for review, or ii) terminate this Ground Lease immediately by providing written notice to SPU.

23.6 The Lessee agrees to provide SPU a copy of all reports prepared by a qualified structural engineer that verify Lessee's tower is in compliance with the current standards of TIA/EIA 222. Lessee shall obtain such report at a minimum of once every five (5) years after the initial installation of its tower on the Leased Land.

23.7 Lessee agrees not to allow vehicles with loading in excess of the federal standard HS20 on the Property, unless specifically approved in writing by SPU.

23.8 Where this Ground Lease has provided Lessee use of roadways on the Property, such use of said roadways shall not be deemed or held to be an exclusive use, or prohibit SPU from granting other permits of like or other nature, or interfere with SPU's use of said access roadways, or affect its jurisdiction of all or any part of it.

23.9 The Lessee understands and agrees that its status under this Ground Lease is only that of interim tenants, with term of tenancy limited by the terms of this Ground Lease; that cancellation or nonrenewal of this Ground Lease for any reason specifically provided in this Ground Lease shall not render the Lessee a "displaced person" and does not qualify it to any benefits under present or future relocation assistance laws, rules or regulations, except as such benefits may be available in accordance with Section 6.2 herein.

23.10 The Lessee agrees to maintain the Leased Land in an orderly, fit and sanitary condition, and to leave the same in an orderly, fit and sanitary condition at the expiration of the Term of this Ground Lease, or upon an earlier termination thereof, and shall peacefully surrender such Leased Land and the use thereof in accordance with the terms of Section 2.3 herein.

23.11 The General Manager & Chief Executive Officer of SPU, or his or her authorized representatives, shall have the right at all reasonable times, upon not less than five (5) business days prior written notice to Lessee and an opportunity for Lessee's representatives to be present, to inspect the Tower Facilities for the purpose of observing the conditions thereof, and the manner of compliance by the Lessee with the terms and conditions of this Ground Lease. SPU may not authorize any third party to access the Tower Facilities without Lessee's consent and without a representative of Lessee being present at the time of such access, unless otherwise required by law, government regulation or court order.

23.12 The Lessee shall not at any time interfere with SPU's access to and over the Property, excluding the Leased Land.

23.13 The Lessee shall be responsible for maintenance of the Leased Land. Lessee shall not place debris outside the Leased Land. If debris is placed outside the Leased Land, SPU reserves the right to remove the debris. The direct cost of the cleanup shall be paid by the Lessee. After initial installation by Lessee, SPU shall maintain the portion of the gravel access road between the Pipe Line Road to the Leased Land in the same manner and condition as Pipe Line Road is currently maintained by SPU.

23.14 The Lessee agrees that use of the Leased Land must be consistent with applicable zoning laws and regulations; where the proposed use is not consistent with said laws, said use is

conditioned upon the Lessee obtaining conditional zoning, or if use is an existing non-conforming use and the local jurisdiction enforces the current zoning.

23.15 The placement of underground utility lines outside the Leased Land must be indicated above ground in a manner approved by the General Manager & Chief Executive Officer of SPU in his or her sole discretion.

23.16 This Ground Lease may be executed in any number of counterparts, each of which, when so executed and delivered, shall be an original, but such counterparts shall together constitute but one and the same.

23.17 Notwithstanding anything to the contrary contained in this Ground Lease, Lessee shall submit to SPU for approval prior to submittal to the granting agency all applications for government grant funds that could affect SPU's use of the Property, which approval shall be within the sole discretion of SPU.

Section 24. Binding Effect

The covenants and agreements of this Ground Lease shall be binding upon and inure to the benefit of SPU and the Lessee and their heirs, executors, administrators, successors and assigns.

Section 25. Entire Agreement

This Ground Lease and its exhibits set forth the entire agreement of the Parties as to the subject matter hereof and supersede all prior discussions and understandings between them. This Ground Lease may not be amended, except by instrument in writing signed by a duly authorized representative of each Party hereto.

Section 26. Non-Discrimination

a. Lessee and SPU, for themselves, their successors, and assigns, as a part of the consideration hereof, do hereby covenant and agree to comply with all civil rights and anti-discrimination requirements of federal, state or local laws applicable to the Property, including, without limitation, Chapter 49.60 RCW. Lessee and SPU shall not discriminate on the basis of race, color, marital status, national origin, religious affiliation, disability, sexual orientation, gender identity or expression or age except by minimum age and retirement provisions, unless based upon a bona fide occupational qualification, in the employment or application for employment or in the administration or delivery of services or any other benefits under King County Code Ch. 12.16.125. Lessee shall comply fully with all applicable federal, state and local laws, ordinances, executive orders and regulations that prohibit such discrimination. These laws include, but are not limited to, Chapter 49.60 RCW, and Titles VI and VII of the Civil Rights Act of 1964. Any violation of this provision shall be considered a Default of this Ground Lease and shall be grounds for cancellation, termination, or suspension, in whole or in part, of this Ground Lease and may result in ineligibility for further agreements between the Parties.

b. Furthermore, Lessee and SPU shall comply with all applicable equal employment opportunity and nondiscrimination laws of the City of Seattle, including but not limited to Chapters 14.04, 14.10 and 20.42 of the Seattle Municipal Code, as they may be amended from time to time, and rules, regulations, orders and directives of the associated administrative agencies and their officers.

Section 27. Termination by Lessee

Lessee retains the right to terminate this Ground Lease for no reason whatsoever upon one (1) year written notice to SPU. In the event of termination of this Ground Lease as provided for in this Section, Lessee shall remove all Personal Property and the Tower Facilities and repair any damage to the Property and the SPU Facilities that Lessee causes, at its sole expense, as provided for in Section 2.3.

Section 28. Interference

a. Where there are existing radio frequency user(s) on the Property, SPU will provide Lessee with a list of all existing radio frequency user(s) on the Property and the frequencies used by each to allow Lessee to evaluate and avoid the potential for interference. Lessee warrants that its use of the Leased Land will not interfere with existing radio frequency user(s) so disclosed by SPU at the time Lessee begins its use of the Leased Land, as long as the existing radio frequency user(s) operate and continue to operate within their respective frequencies and in accordance with all applicable laws, licenses and manufacturers' specifications. Lessee shall perform a radio frequency intermodulation study prior to the installation of the Tower Facilities on the Leased Land to confirm that such proposed installation will not create interference with any existing radio frequency user(s) on the Property.

b. Without Lessee's prior written consent, which shall not be unreasonably withheld, conditioned or delayed, SPU will not grant a lease, license or any other right to any third party for the use of the Property if such use may in any way adversely affect or interfere with Lessee's equipment, Lessee's operations, or Lessee's rights under this Ground Lease.

c. SPU further agrees to include in all future leases, licenses and agreements to utilize the Property the requirement to comply with terms that are substantially equivalent to the following: (i) comply with the rules, regulations, and licenses of the Federal Communications Commission ("FCC"); (ii) cease operating any equipment which causes interference within twenty-four (24) hours after receipt of written notice of interference, except for intermittent testing to determine the cause of such interference, until the interference has been corrected; (iii) perform radio frequency intermodulation studies prior to the installation of additional equipment or radio frequencies to confirm that the proposed installation will not create interference with existing uses; (iv) reasonably cooperate with other users in order to troubleshoot the cause of any radio frequency interference which may arise; and (v) the last user to add equipment on the Property that causes radio frequency interference shall have primary responsibility to investigate the cause of the interference and to incur the expense to cure the interference. If the interference cannot be cured using commercially reasonable efforts, such user shall remove from the Property the equipment that causes the interference.

d. Lessee acknowledges and agrees that the primary purpose of the Property is for the continued operation and maintenance of the City of Seattle’s water and electric utility facilities and that the permissions granted herein are subject to those operations. In the event that any non-communications facilities create any interference, SPU agrees to cooperate with Lessee in determining the cause of the interference. Notwithstanding any laws or regulation to the contrary, Lessee agrees that SPU shall not be required to cease operation of any of the SPU Facilities, nor shall it be required to pay for costs associated with studying or modifying Lessee’s equipment to accommodate the SPU Facilities.

e. For the purposes of this Ground Lease, “interference” includes harmful interference as defined by the FCC, and any use on the Property or surrounding property that causes physical obstruction with the use of the Leased Land.

Section 29. Disaster

In the event the Tower Facilities or Leased Land are destroyed or damaged by fire, earthquake or other casualty so as to render the Tower Facilities or Leased Land unfit for use as provided for herein, Lessee may terminate this Ground Lease upon written notice to SPU given within forty-five (45) days after the date of the damage or destruction, the effective termination date for which shall be retroactive to the date of damage or destruction. If the Lessee believes it is feasible to relocate the Tower Facilities to a different location on the Property, SPU will endeavor to provide an interim site for Lessee to locate temporary, mobile Tower Facilities and equipment as necessary to continue service during repair or relocation of the Leased Land or Tower Facilities. Unless otherwise agreed in writing by SPU, the permission for any interim site shall cease one (1) year after the date of the damage or destruction.

Section 30. Exhibits

The following Exhibits are attached hereto and hereby incorporated and made a part of this Ground Lease:

- Exhibit A: Legal Description of SPU’s Property
- Exhibit B: Legal Description and Depiction of Leased Land and Depiction of Tower Facilities
- Exhibit C: SPU approved Site Plans (to be attached upon SPU approval, which need not be prior to the Effective Date of this Ground Lease)

[SIGNATURES ON FOLLOWING PAGE]

GRANTED as of the Effective Date.

KING COUNTY,
a political subdivision of the State of Washington

THE CITY OF SEATTLE,
a municipal corporation of the State of
Washington, by and through its Seattle
Public Utilities Department

By: _____
Name: Anthony O. Wright
Its: Director, Facilities Management Division
Date: _____

By: _____
Name: _____
Its: General Manager & Chief Executive Officer
Date: _____

Approved as to form:

Busch Law Firm PLLC

EXHIBIT A
(Legal description of Property)

Legal Description of SPU's Property:

THOSE PORTIONS OF SECTIONS 29, 30, 31 AND 32, TOWNSHIP 26 NORTH, RANGE 8 EAST, W.M., IN KING COUNTY, WASHINGTON, LYING SOUTHERLY OF THE SOUTHERLY LINE OF THAT TRACT OF LAND CONVEYED TO THE CITY OF SEATTLE BY DEED RECORDED UNDER RECORDING NUMBER 4987895, EASTERLY OF THE THREAD OF THE STOSSEL CREEK, NORTHERLY OF THE THREAD OF THE TOLT RIVER, NORTHERLY AND NORTHWESTERLY OF THE THREAD OF THE NORTH FORK OF THE TOLT RIVER AND WESTERLY OF THE THREAD OF NORTH FORK CREEK.

SITUATE IN THE COUNTY OF KING, STATE OF WASHINGTON.

APN: 292608 9004

Address: 39025 NE North Fork Road, Duvall, WA 98019

EXHIBIT B
(Legal Description and Depiction of Leased Land and Depiction of Tower Facilities)
(Page 1 of 3)

Legal Description of the Leased Land:

A PORTION OF SECTION 29 TOWNSHIP 26 NORTH, RANGE 8 EAST, W.M., IN KING COUNTY, WASHINGTON IS BEING MORE PARTICULARLY DESCRIBED AS FOLLOWS:

COMMENCING AT THE WESTERLY QUARTER CORNER OF SAID SECTION 29;
THENCE SOUTH 00°14'23" WEST, A DISTANCE OF 872.34 FEET ALONG THE WEST LINE OF SAID SECTION TO THE BEGINNING OF A NON-TANGENT CURVE TO THE LEFT FROM WHICH THE CENTER BEARS NORTH 85°04'17" EAST, SAID CURVE HAVING A RADIUS OF 999.21 FEET; THENCE ALONG THE ARC OF SAID CURVE A DISTANCE OF 287.00 FEET THROUGH A CENTRAL ANGLE OF 16°27'24 TO A CONCRETE MONUMENT;
THENCE NORTH 76°50'35" EAST, A DISTANCE OF 780.59 FEET TO A CONCRETE MONUMENT;
THENCE SOUTH 12°59'18" EAST, A DISTANCE OF 135.59 FEET TO THE POINT OF BEGINNING;
THENCE SOUTH 10°54'37" EAST, A DISTANCE OF 77.00 FEET;
THENCE SOUTH 79°05'23" WEST, A DISTANCE OF 104.00 FEET;
THENCE NORTH 10°54'37" WEST, A DISTANCE OF 77.00 FEET;
THENCE NORTH 79°05'23" EAST, A DISTANCE OF 104.00 FEET TO THE POINT OF BEGINNING.



Depiction of Leased Land & Tower Facilities:
See following 2 pages of Exhibit B.

EXHIBIT B
(Page 2 of 3)

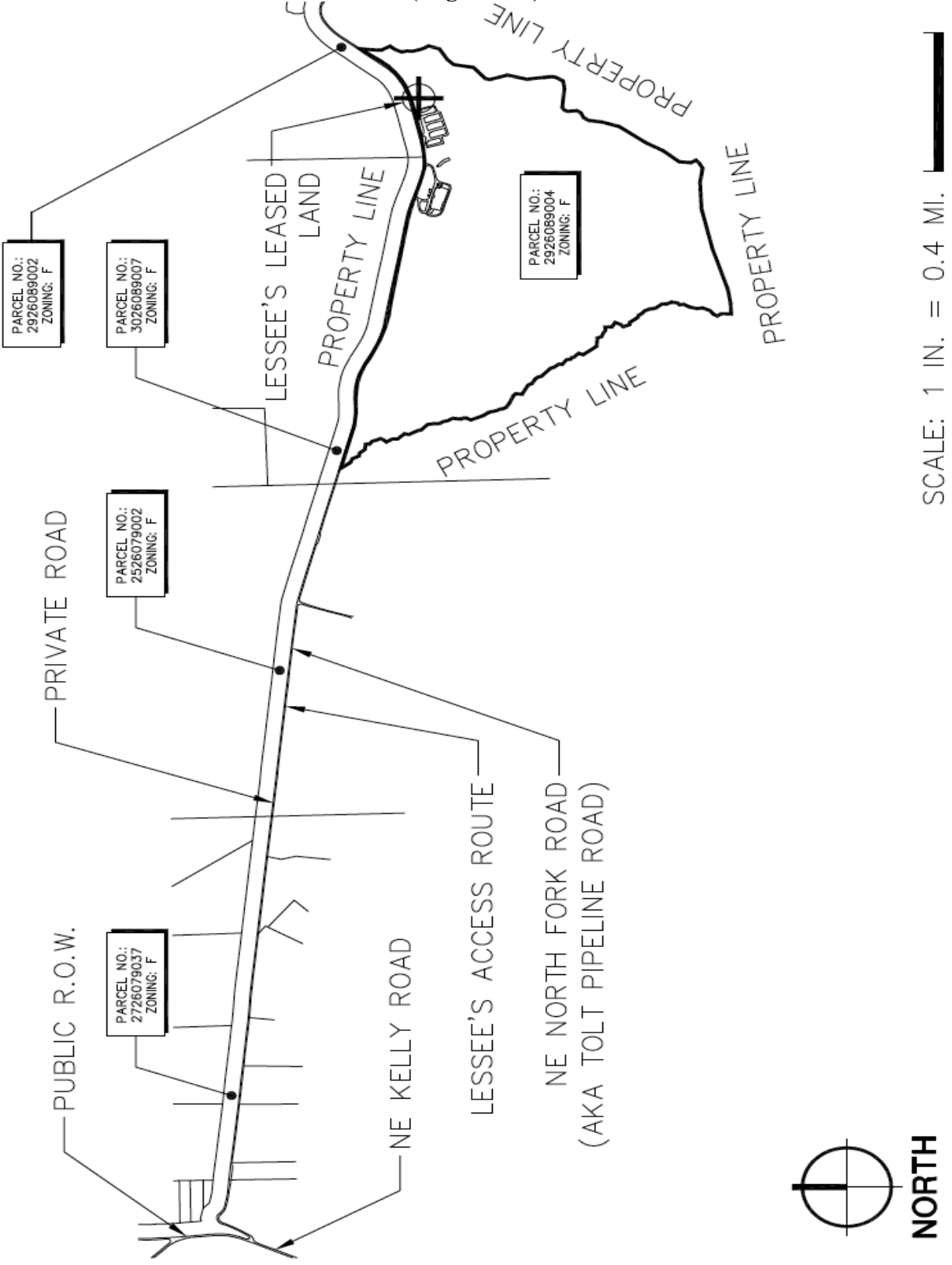

EXHIBIT B
(Page 3 of 3)

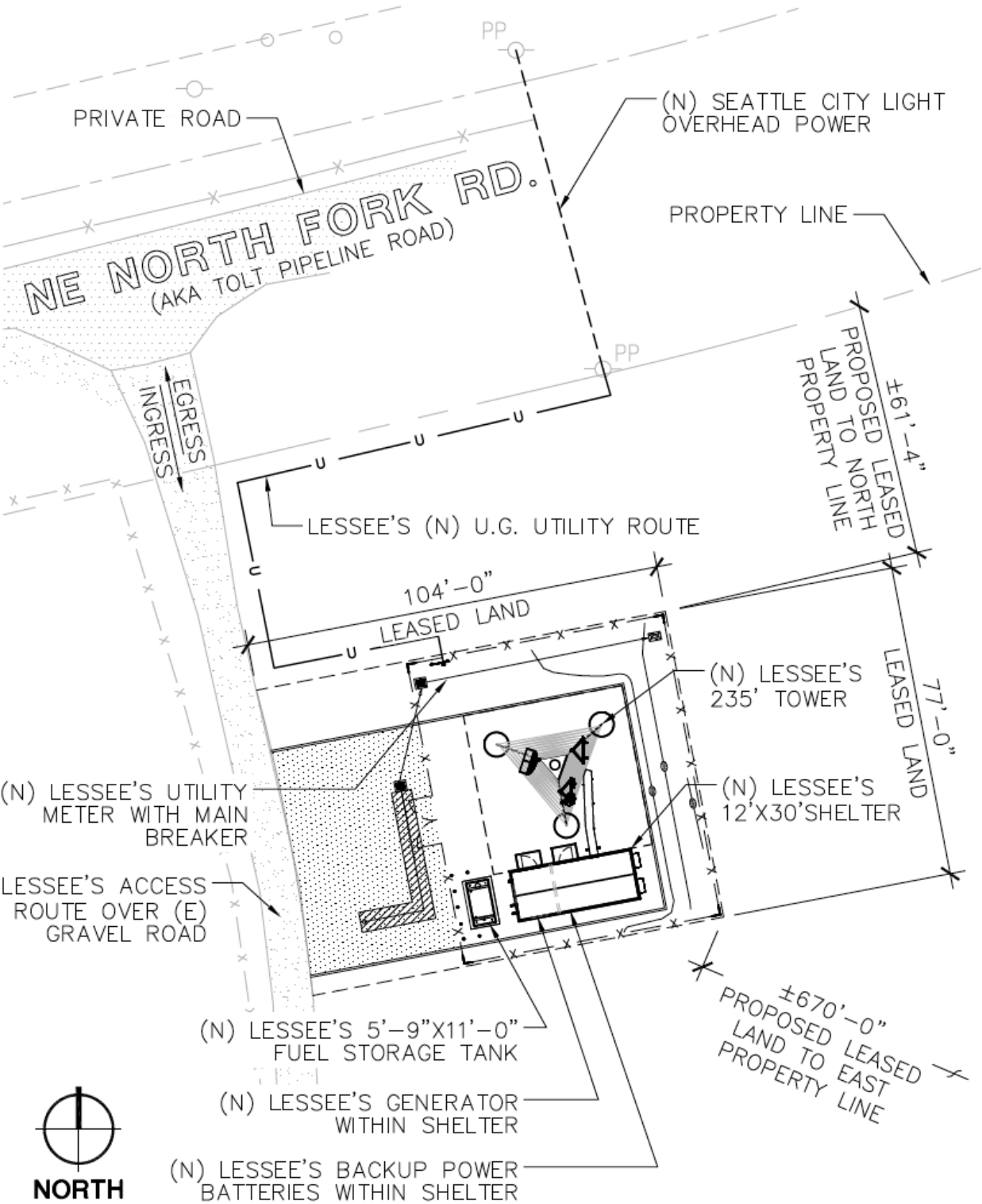

EXHIBIT C
(SPU approved Site Plans)

See attached 28 pages.

SHEET INDEX

ARCHITECTURAL	T-1	TITLE SHEET
	SP-1	GENERAL NOTES
	SV-1	SPECIAL INSPECTIONS
	CV-1	CIVIL SURVEY
	SV-1.0	COVER SHEET AND GENERAL NOTES
	C2.1	TEMPORARY EROSION CONTROL PLAN
	C2.2	TEMPORARY EROSION CONTROL DETAILS
	C3.1	GRADING AND DRAINAGE PLAN
	A-1.0	OVERALL PROPOSED SITE PLAN
	A-1.1	ENLARGED PROPOSED SITE PLAN
	A-2	ANTENNA PLAN
	A-3	PROPOSED ELEVATIONS
	A-4.0	DETAILS
	A-4.1	DETAILS
	A-4.2	DETAILS
	A-4.3	SHELTER PLAN AND ELEVATIONS
	A-4.4	GENERATOR DETAIL
	A-4.5	BATTERY SYSTEM

STRUCTURAL	FT.1	BUILDING AND FUEL TANK FOUNDATIONS
	F2.1	STRUCTURAL NOTES
		BUILDING AND TANK FOUNDATION PLANS AND DETAILS

TOWER	D-143905	SLAB FOUNDATION INSTALLATION
	B-143904	STRESS ANALYSIS

MECHANICAL	M1.0	FUEL SYSTEM PIPING PLAN
------------	------	-------------------------

ELECTRICAL	E-1	ELECTRICAL SITE PLAN
	E-2	ONE LINE DIAGRAM & PANEL SCHEDULE
	E-3.0	GROUNDING PLANS & NOTES
	E-3.1	GROUNDING PLANS & NOTES
	E-3.2	BOUNDARY DETAILS & NOTES

WASHINGTON STATE CODE COMPLIANCE:

2015 IBC, STANDARDS AND AMENDMENTS, WAC 51-50
 2015 IMC, STANDARDS AND AMENDMENTS, WAC 51-52
 2015 IFC, STANDARDS AND AMENDMENTS, WAC 51-54
 2015 UPC, STANDARDS AND AMENDMENTS, WAC 51-56, 51-57
 2014 NEC, STANDARDS AND AMENDMENTS, WAC 296-46B
 2015 IECC/WASHINGTON STATE ENERGY CODE, WAC 51-11C

PROJECT SUMMARY

PROJECT MANAGER:
 KING COUNTY DEPARTMENT OF INFORMATION TECHNOLOGY (KOT)
 5505 6TH AVENUE S, SUITE 202
 SEATTLE, WA 98108
 CONTACT: BRYSON BURGHARDT
 OFFICE: 206-460-3084
 CELL: 206-550-3084
 PHONE: 206-263-7846
 EMAIL: Hai.Phung@KingCounty.gov

PERMITTING CONTACT:
 ODELIA PACIFIC CORPORATION
 5505 6TH AVENUE S, SUITE 202
 SEATTLE, WA 98108
 CONTACT: MARK RILEY
 PHONE: 425-443-2128
 EMAIL: MRiley@Odella.com

A/E/VENDOR:
 ODELIA PACIFIC CORPORATION
 5505 6TH AVENUE S, SUITE 202
 SEATTLE, WA 98108
 CONTACT: MARK RILEY
 PHONE: 425-443-2128
 EMAIL: MRiley@Odella.com

DESIGN CONSULTANT:
 CAMP + ASSOCIATES, INC.
 19401 40TH AVE W, SUITE 304
 LYNNWOOD, WA 98036
 CONTACT: ERIC CAMP
 PHONE: 425-740-6392
 OFFICE: 206-477-3772
 MOBILE: 206-822-4272
 EMAIL: Robert.Camp@KingCounty.gov

SITE NAME: SWAN
SITE ADDRESS: 39025 NE NORTH FORK RD.
 DUVALL, WA 98019

LAND OWNER: SEATTLE CITY OF SPU-WTR

JURISDICTION: KING COUNTY

PARCEL NUMBER: 292608-9004

PARCEL SIZE: 19,920,000 SQ. FT. (457.3 ACRES)

ZONING: F (FOREST)

OCCUPANCY: U (UNOCCUPIED)

CONSTRUCTION TYPE: V-B

NEW IMPERVIOUS SURFACES: 4,931 SQ. FT.

PROJECT DESCRIPTION:

(THE SCOPE OF WORK INCLUDES)
 NEW KING COUNTY PUGET SOUND EMERGENCY RADIO NETWORK
 NEW KING COUNTY PUGET SOUND EMERGENCY RADIO NETWORK
 (P-SERN). 235' TOWER AND ASSOCIATED EQUIPMENT TO PROVIDE
 EMERGENCY RADIO COMMUNICATIONS TO REACH AND COORDINATE
 WITH EMERGENCY RESPONDERS.

PUGET SOUND EMERGENCY RADIO NETWORK

(NEW BUILD)

SWAN

39025 NE NORTH FORK RD.

DUVALL, WA 98019

LATITUDE: 47°42'23.62" N (NAD 83)

LONGITUDE: 121°49'01.66" W (NAD 83)

GROUND ELEVATION: 698.70' (NAVD 88)

SEPARATE PERMITS TO BE OBTAINED FROM FIRE DEPARTMENT:

- FUEL TANKS
- GENERATOR
- FUEL PIPING
- FIRE SUPPRESSION SYSTEM: FM200

CONFIDENTIAL AND PROPRIETARY

SIGNATURE BLOCK

TITLE	SIGNATURE	DATE
CONSTRUCTION MANAGER		
RF ENGINEER		
REAL ESTATE		
SITE ACQUISITION		
PROPERTY OWNER		
TOWER OWNER		

AREA MAP

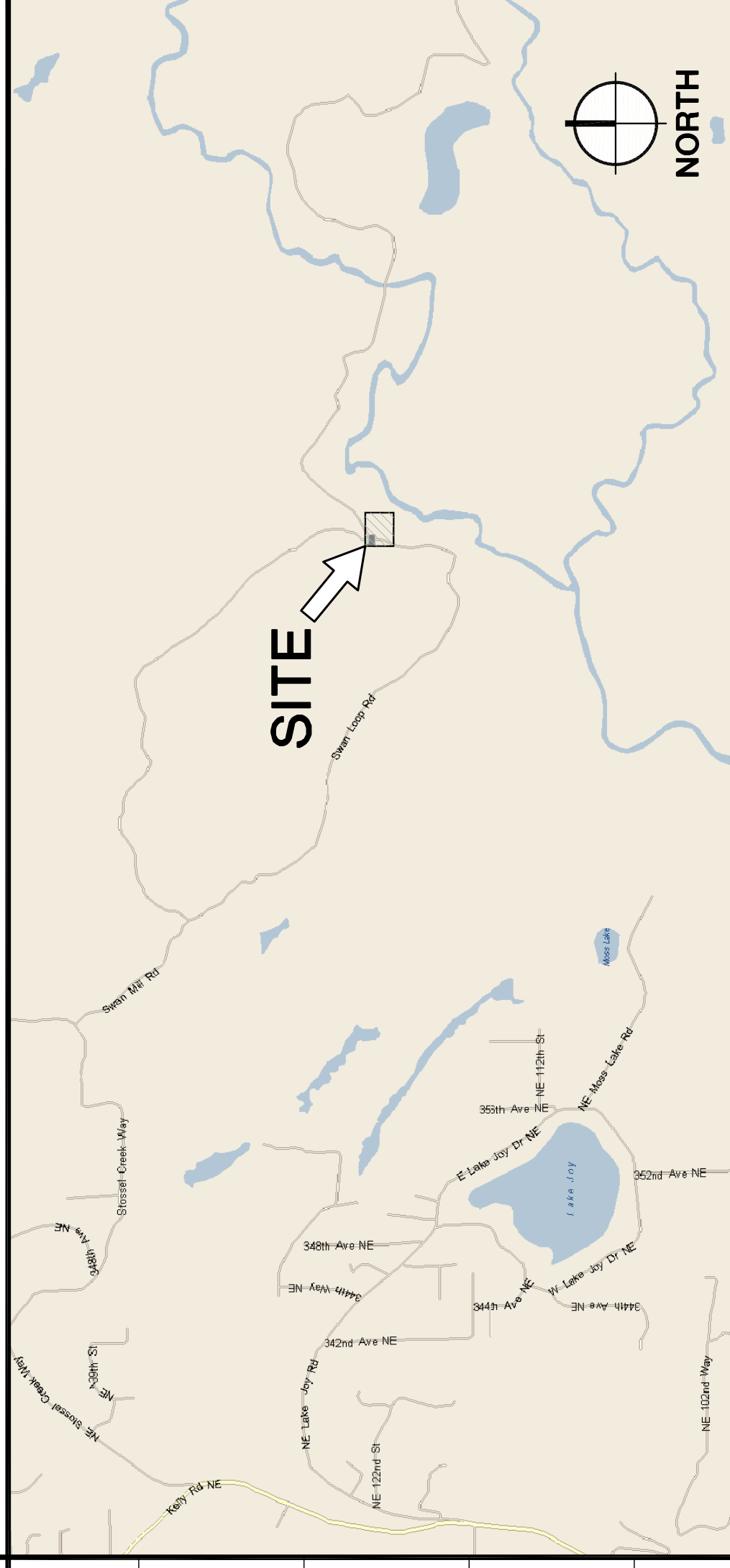

DRIVING DIRECTIONS:

1) DEPART 401 5TH AVE. ON 5TH AVE. S (SOUTH) [0.2 MI.] 2) TURN RIGHT (WEST) ONTO S JACKSON ST. [164 YDS] 3) TURN LEFT (SOUTH-EAST) ONTO 2ND AVE. EXIT S THEN IMMEDIATELY BEAR RIGHT (SOUTH) ONTO 4TH AVE. S [0.4 MI.] ROAD NAME CHANGES TO WA-519 [0.1 MI.] 4) KEEP STRAIGHT ONTO 4TH AVE. S [21 YDS] 5) KEEP RIGHT ONTO RAMP [0.1 MI.] 6) TURN LEFT (EAST) ONTO EDGAR MARTINEZ DR. S [32 YDS] 7) KEEP STRAIGHT ONTO RAMP [0.2 MI.] 8) AT EXIT 2A, TAKE RAMP (RIGHT) ONTO [0.1 MI.] 9) AT EXIT 149, TURN RIGHT ONTO RAMP [0.3 MI.] 10) TURN LEFT (EAST) ONTO WA-516 [2.9 MI.] 11) TAKE RAMP (RIGHT) ONTO WA-167 [12.6 MI.] 12) TAKE RAMP (RIGHT) ONTO WA-410 [11.2 MI.] 13) TURN RIGHT (SOUTH) ONTO MUNDT LOSS RD. E [1.2 MI.] 14) BEAR LEFT (SOUTH-EAST) ONTO WA-162 [0.2 MI.] 15) BEAR RIGHT (SOUTH) ONTO WA-165 [2.2 MI.] 16) KEEP STRAIGHT ONTO WA-165 [0.1 MI.] 17) KEEP STRAIGHT ONTO WA-165 [0.6 MI.] 18) BEAR LEFT (SOUTH-EAST) ONTO RAILROAD AVE. [0.3 MI.] 19) ROAD NAME CHANGES TO QUINNON EXT. RD. E [0.4 MI.] 20) TURN RIGHT (SOUTH-EAST) ONTO LOCAL ROAD [0.4 MI.] 21) BEAR LEFT (EAST) ONTO SNELL LAKE RD. [0.3 MI.] ROAD NAME CHANGES TO S PRAIRIE CREEK RD. [0.4 MI.] ROAD NAME CHANGES TO NF-7710 [3.2 MI.] 22) TAKE LOCAL ROADS TO SITE.

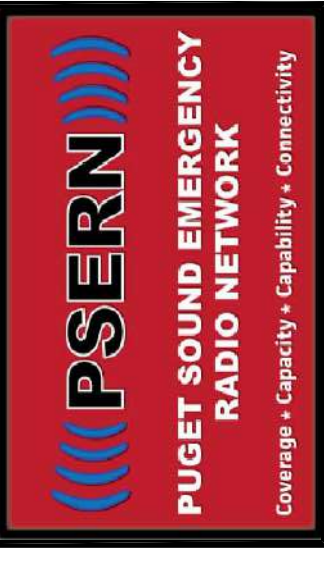

SWAN
 (NEW BUILD)
 39025 NE NORTH FORK RD.
 DUVALL, WA 98019

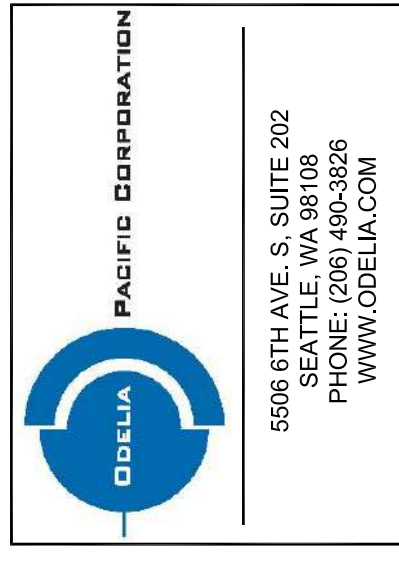

PROJECT MANAGER: EJC
PREPARED BY: AID/EAT

APPROVED BY: PN

07/31/17	UPDATED SURVEY
07/27/17	DEPER COMMENTS
06/27/17	ELECTRICAL TIE-IN W/ SCL
06/15/17	ISSUED FOR PERMIT

PLAN REVIEWERS SIGNATURE

ARCHITECTS STAMP
 7727 REGISTERED ARCHITECT
 ODELIA PACIFIC CORPORATION
 STATE OF WASHINGTON

SHEET NAME
TITLE SHEET
SHEET NUMBER
T-1

CONTRACTOR NOTES:

THE ARCHITECTS/ENGINEERS HAVE MADE EVERY EFFORT TO SET FORTH IN THE CONSTRUCTION AND CONTRACT DOCUMENTS THE COMPLETE SCOPE OF WORK. CONTRACTORS BIDDING ON THE DRAWINGS AND SPECIFICATIONS SHALL NOT COMMISSIONS OR ERRORS IN THE DRAWINGS AND OR SPECIFICATIONS SHALL NOT EXCUSE SAID CONTRACTOR FROM COMPLETING THE PROJECT AND IMPROVEMENTS IN ACCORDANCE WITH THE INTENT OF THESE DOCUMENTS. THE BIDDER SHALL BEAR THE RESPONSIBILITY OF NOTIFYING (IN WRITING) THE ARCHITECT/ENGINEER OF ANY CONFLICTS, ERRORS, OR OMISSIONS PRIOR TO THE SUBMISSION OF CONTRACTOR'S PROPOSALS. IN THE EVENT OF DISCREPANCIES BETWEEN THE DRAWINGS AND MORE COSTLY OR EXTENSIVE WORK, UNLESS DIRECTED OTHERWISE.

GENERAL NOTES:

DRAWINGS ARE NOT TO BE SCALED. WRITTEN DIMENSIONS TAKE PRECEDENCE, AND THIS SET OF PLANS IS INTENDED TO BE USED FOR DIAGRAMMATIC PURPOSES ONLY, UNLESS NOTED OTHERWISE. THE GENERAL CONTRACTOR'S SCOPE OF WORK SHALL INCLUDE FURNISHING ALL MATERIALS, EQUIPMENT, LABOR, AND ANYTHING ELSE DEEMED NECESSARY TO COMPLETE INSTALLATIONS AS DESCRIBED HEREIN.

PRIOR TO THE SUBMISSION OF BIDS, THE CONTRACTORS INVOLVED SHALL VISIT THE JOB SITE AND FAMILIARIZE THEMSELVES WITH ALL CONDITIONS AFFECTING THE NEW PROJECT, WITH THE CONSTRUCTION AND CONTRACT DOCUMENTS, FIELD CONDITIONS AND CONFIRM THAT THE PROJECT MAY BE ACCOMPLISHED AS SHOWN PRIOR TO PROCEEDING WITH CONSTRUCTION. ANY ERRORS, OMISSIONS, OR DISCREPANCIES ARE TO BE BROUGHT TO THE ATTENTION OF THE ARCHITECT/ENGINEER IN WRITING.

THE GENERAL CONTRACTOR SHALL RECEIVE WRITTEN AUTHORIZATION TO PROCEED WITH CONSTRUCTION PRIOR TO STARTING WORK ON ANY ITEM NOT CLEARLY DEFINED BY THE CONSTRUCTION DRAWINGS/CONTRACT DOCUMENTS.

THE CONTRACTOR SHALL SUPERVISE AND DIRECT THE PROJECT DESCRIBED HEREIN. THE CONTRACTOR SHALL BE SOLELY RESPONSIBLE FOR ALL CONSTRUCTION MEANS, METHODS, TECHNIQUES, SEQUENCES AND PROCEDURES AND FOR COORDINATING ALL PORTIONS OF THE WORK UNDER THE CONTRACT.

THE CONTRACTOR SHALL INSTALL ALL EQUIPMENT AND MATERIALS ACCORDING TO MANUFACTURER'S/ VENDOR'S SPECIFICATIONS UNLESS NOTED OTHERWISE OR WHERE LOCAL CODES OR ORDINANCES TAKE PRECEDENCE.

ALL WORK PERFORMED ON PROJECT AND MATERIALS INSTALLED SHALL BE IN STRICT ACCORDANCE WITH ALL APPLICABLE CODES, REGULATIONS AND ORDINANCES. CONTRACTOR SHALL GIVE ALL NOTICES AND COMPLY WITH ALL LAWS, ORDINANCES, RULES, REGULATIONS AND LAWFUL ORDERS OF ANY PUBLIC AUTHORITY, MUNICIPAL AND UTILITY COMPANY SPECIFICATIONS, AND LOCAL AND STATE JURISDICTIONAL CODES BEARING ON THE PERFORMANCE OF THE WORK.

THE STRUCTURAL COMPONENTS OF THIS PROJECT SITE/FACILITY ARE NOT TO BE ALTERED BY THIS CONSTRUCTION PROJECT UNLESS NOTED OTHERWISE.

ANTENNA SUPPORTING TOWER IS FURNISHED BY OWNER. INSTALLED BY CONTRACTOR. CONTRACTOR SHALL BE RESPONSIBLE FOR THE PROTECTION OF ALL UTILITIES, AND SHALL BE RESPONSIBLE FOR PROTECTION OF PERSONNEL AND PROPERTY FROM HAZARDOUS EXPOSURE TO OVERHEAD DANGERS.

GENERAL CONTRACTOR SHALL PROVIDE AT THE PROJECT SITE A FULL SET OF CONSTRUCTION DOCUMENTS UPDATED WITH THE LATEST REVISIONS AND ADDENDA OR CLARIFICATIONS FOR THE USE BY ALL PERSONNEL INVOLVED WITH THE PROJECT.

DETAILS INCLUDED HEREIN ARE INTENDED TO SHOW END RESULT OF DESIGN. MINOR MODIFICATIONS MAY BE REQUIRED TO SUIT JOB CONDITIONS OR SITUATIONS, AND SUCH MODIFICATIONS SHALL BE INCLUDED AS PART OF THE SCOPE OF WORK.

THE CONTRACTOR SHALL MAKE NECESSARY PROVISIONS TO PROTECT EXISTING IMPROVEMENTS, EASEMENTS, PAVING, CURBING, ETC. DURING CONSTRUCTION UPON COMPLETION OF WORK. CONTRACTOR SHALL REPAIR ANY DAMAGE THAT MAY HAVE OCCURRED DUE TO CONSTRUCTION ON OR ABOUT THE PROPERTY.

CONTRACTOR SHALL ENSURE THE GENERAL WORK AREA IS KEPT CLEAN AND HAZARDOUS MATERIALS ARE NOT ACCUMULATED. RUBBISH, STUMPS, STONES AND OTHER REFUSE SHALL BE REMOVED FROM THE PROJECT SITE AND DISPOSED OF LEGALLY. ALL SURFACES SHALL BE LEFT IN CLEAN CONDITION AND FREE FROM PAINT SPOTS, DUST, OR SMUDGES OF ANY NATURE.

THE CONTRACTOR SHALL COMPLY WITH ALL LOCAL AND NATIONAL CODES, REGULATIONS AND SAFETY REGULATIONS, ALL OSHA REGULATIONS, ALL PUBLIC AND MUNICIPAL AUTHORITIES, AND ANY UTILITY COMPANIES' REGULATIONS AND DIRECTIVES.

THE DRAWINGS AND SPECIFICATIONS ARE A GENERAL DIRECTIVE FOR THE SCOPE OF WORK. EXACT DIMENSIONS AND LOCATIONS MAY CHANGE AND BE DIFFERENT FROM ALL DISCREPANCIES TO REPRESENTATIVE ANY MINOR ERRORS AND OMISSIONS IN THE DRAWINGS AND SPECIFICATIONS DOES NOT EXCUSE THE CONTRACTOR FROM COMPLETING THE PROJECT AND IMPROVEMENTS IN ACCORDANCE WITH THE INTENT OF THESE DOCUMENTS.

CONTRACTOR IS RESPONSIBLE FOR FIELD MEASUREMENTS TO CONFIRM LENGTHS OF CABLE TRAYS AND ELECTRICAL LINES AND ANTENNA MOUNTING.

VERIFICATION THAT EXISTING TOWER/POLE/STRUCTURE CAN SUPPORT THE PROPOSED ANTENNA, COAX & ADDITIONAL EQUIPMENT LOADING IS TO BE DONE BY OTHERS.

CIVIL NOTES:

1. ALL SITE WORK SHALL BE AS INDICATED ON THE DRAWINGS AND STIPULATED IN THE SPECIFICATION PROJECT SUMMARY.
2. RUBBISH, STUMPS, DEBRIS, STICKS, STONES AND OTHER REFUSE SHALL BE REMOVED FROM THE SITE AND DISPOSED OF LEGALLY.
3. THE SITE SHALL BE GRADED TO CAUSE SURFACE WATER TO FLOW AWAY FROM THE COMMUNICATIONS EQUIPMENT, TOWER AREAS, AND ADJACENT BUILDINGS.
4. NO FILL OR EMBANKMENT MATERIAL SHALL BE PLACED ON FROZEN GROUND. FROZEN MATERIALS, SNOW OR ICE SHALL NOT BE PLACED IN ANY FILL OR EMBANKMENT.
5. THE SUBGRADE SHALL BE COMPACTED AND BROUGHT TO A SMOOTH UNIFORM GRADE PRIOR TO THE CRUSHED STONE APPLICATION.

SUBGRADE AND BASE PREPARATION:

1. FOR SLAB-ON-GRADE CONSTRUCTION IT WILL BE NECESSARY TO OVEREXCAVATE THE SITE BY 2'-0" AND IMPORT AN APPROVED GRANULAR FILL. THE FILL SHALL BE COMPACTED TO AT LEAST 95% OF THE MAXIMUM DRY UNIT WEIGHT WITH A MOISTURE CONTENT WITHIN 2% OF THE OPTIMUM MOISTURE CONTENT AS DETERMINED BY THE MODIFIED PROCTOR TEST (ASTM D-1557). COMPACTON REQUIREMENTS APPLY TO BACKFILL FOR UTILITY TRENCHES AND FOUNDATION EXCAVATIONS WITHIN STRUCTURES, DRIVEWAYS, OR PARKING LOT AREAS.
2. COMPACTON SHALL BE ACCOMPLISHED BY PLACING THE FILL IN SUCCESSIVE HORIZONTAL LAYERS APPROXIMATELY SIX- TO EIGHT-INCH LOOSE LIFTS AND MECHANICALLY COMPACTING EACH LIFT TO AT LEAST THE SPECIFIED MINIMUM DRY DENSITY.
3. ANY ORGANIC MATERIAL, DELETERIOUS MATERIAL, OR DISTURBED SOIL SHALL BE REMOVED FROM FLATWORK AREAS.
4. THE GROUND SURFACE SURROUNDING EXTERIOR STRUCTURES SHALL BE SLOPED TO DRAIN AWAY IN ALL DIRECTIONS.

CONCRETE NOTES:

REFER TO STRUCTURAL DRAWINGS.

METAL NOTES:

PART 1 — GENERAL

1. SECTION INCLUDES:
STRUCTURAL STEEL FRAMING MEMBERS, BASE PLATES, PLATES, BARS AND GROUTING UNDER BASE PLATES.
2. SHOP DRAWINGS: INDICATE SIZES, SPACING, AND LOCATIONS OF STRUCTURAL MEMBERS, OPENINGS, CONNECTIONS, CAMBERS, LOADS, AND WELDED SECTIONS.
3. QUALITY ASSURANCE
A. FABRICATE STRUCTURAL STEEL MEMBERS IN ACCORDANCE WITH AISC SPECIFICATIONS FOR THE DESIGN, FABRICATION AND ERECTION OF STRUCTURAL STEEL FOR BUILDINGS.
B. PERFORM DESIGN UNDER DIRECT SUPERVISION OF A PROFESSIONAL STRUCTURAL ENGINEER LICENSED IN THE STATE.

PART 2 — PRODUCTS

1. MATERIALS:
A. STRUCTURAL STEEL MEMBERS: ASTM A572, GRADE 50
B. STRUCTURAL TUBING: ASTM A500, GRADE B
C. PIPE: ASTM A53, TYPE E OR S, GRADE B
D. BOLTS, NUTS, AND WASHERS: ASTM A325
E. ANCHOR BOLTS: ASTM A307
F. WELDING MATERIALS: AWS D1.1, TYPE REQUIRED FOR MATERIALS BEING WELDED
G. GROUT: NON-SHRINK TYPE, PREMIUM COMPOUND CONSISTING OF NONMETALLIC AGGREGATE, CEMENT, WATER REDUCING AND PLASTICIZING ADDITIVES, CAPABLE OF DEVELOPING A MINIMUM COMPRESSIVE STRENGTH OF 7000 psi AT 28 DAYS.
H. SHOP AND TOUCH-UP PRIMER: SSPC 15, TYPE 1, RED OXIDE
I. TOUCH-UP PRIMER FOR GALV. SURFACES: ZINC RICH TYPE
2. FABRICATION:
CONTINUOUSLY SEAL JOINTED MEMBERS BY CONTINUOUS WELDS. GRIND EXPOSED WELDS SMOOTH.
3. FINISH:
A. PREPARE STRUCTURAL COMPONENT SURFACES IN ACCORDANCE WITH SSPC SP-1 TO SP-10 PROCEDURES.
B. STRUCTURAL STEEL MEMBERS SHALL BE HOT DIPPED GALVANIZED.

PART 3 — EXECUTION

1. EXAMINATION AND PREPARATION:
VERIFY THAT THE FIELD CONDITIONS ARE ACCEPTABLE.
2. ERECTION:
A. ALLOW FOR ERECTION LOADS. PROVIDE TEMPORARY BRACING TO MAINTAIN FRAMING IN ALIGNMENT UNTIL COMPLETION OF ERECTION AND INSTALLATION OF PERMANENT BRIDGING AND BRACING.
B. FIELD WELD COMPONENTS INDICATED ON SHOP DRAWINGS.
C. DO NOT FIELD CUT OR ALTER STRUCTURAL MEMBERS WITHOUT APPROVAL OF THE ARCHITECT/ENGINEER.
D. AFTER ERECTION, TOUCH-UP WELDS, ABRASIONS, AND SURFACES NOT SHOP PRIMED OR GALVANIZED WITH TOUCH-UP PRIMERS AS SPECIFIED UNDER SECTION 05000-METALS, PART 2.1. PRODUCTS, H & I. SURFACES TO BE IN CONTACT WITH CONCRETE NOT INCLUDED.
3. FIELD QUALITY CONTROL:
FIELD INSPECTION OF MEMBERS, CONNECTIONS, WELDS AND TORQUING.

ELECTRICAL NOTES:

INSTALLATION OF SECONDARY POWER AND CONNECTION TO METER SHALL BE COMPLETED IN COMPLIANCE WITH NATIONAL ELECTRIC CODE, NFPA 70, AND THE STATE LAWS, RULES AND REGULATIONS FOR INSTALLING ELECTRIC WIRES & EQUIPMENT, ALL LATEST ISSUE, AND WITH SPECIFICATIONS PER A.S.T.M. B 231, B 400, I.C.E.A. S651-401, I.C.E.A. P81-570, & LOCAL PUD.

PROVIDE A METER BASE PER LOCAL UTILITY STANDARDS. MOUNT ON SIDE OF OWNER FURNISHED BACK BOARD.

UNDERGROUND CONDUIT SHALL BE RIGID POLYVINYL CHLORIDE CONDUIT: SCHEDULE 40, TYPE 1, CONFORMING TO UL ARTICLE 651: WESTERN PLASTICS OR CARLON MANUFACTURER. COUPLINGS SHALL BE SLIP-ON, SOLVENT SEALED T PIPE, SOLVENT, WESTERN TYPE COMPATIBLE WITH PVC DUCT. ALL BENDS SHALL BE "WIDE SWEEP" TYPE WITH A 24" MINIMUM RADIUS. ALL CONDUIT UNDER ROADS SHALL BE RGS, (OR PVC ENCASED IN 8"x18" RED CONCRETE DUCTBANK).

CONDUIT USED INDOORS SHALL BE E.M.T., AND RIGID GALVANIZED STEEL FOR OUTDOORS. COUPLINGS SHALL BE RIGID STEEL AND COMPRESSION TYPE FOR E.M.T. SET. SCREW FITTINGS ARE NOT PERMITTED. FOR ALL STUBS-UPS, USE RIGID GALVANIZED STEEL CONDUIT.

WIRE AND CABLE SHALL BE OF THE TYPE AND SIZE AS REQUIRED BY NEC. THERE WILL BE NO SPALCES ALLOWED.
PROVIDE HDPE PULLING HAND HOLES AS NEEDED.

CONTRACTOR SHALL PROVIDE TEST OF THE GROUNDING SYSTEM BY CERTIFIED TESTING AGENT. PROVIDE INDEPENDENT TEST RESULTS TO THE PROJECT REPRESENTATIVE FOR REVIEW. GROUNDING SYSTEM RESISTANCE TO GROUND SHALL NOT EXCEED 5 OHMS. ALL ELECTRICAL SYSTEMS SHALL BE GROUNDED TO THE SAME GROUNDING POINT. COMPRESSION TYPE INTERIOR AND EXTERIOR GROUNDING CONDUIT SHALL BE USED FOR ALL BELOW GRADE AND EXPOSED EXTERIOR GROUNDING CONNECTIONS TO PERMANENT EQUIPMENT AND FIXED BUILDING ELEMENTS SHALL BE CADDLED TYPE. CARE SHALL BE TAKEN TO REVIEW CONNECTION LOCATIONS AND MATERIAL TYPES TO AVOID POSSIBLE GALVANIC CORROSION. ALL EXPOSED GROUNDING CONNECTIONS TO BE COATED WITH ANTI-CORROSIVE AGENT SUCH AS "NO-OXY", "NOALOX" OR "PENETROX". VERIFY PRODUCT WITH PROJECT REPRESENTATIVE. ALL BOLTS, WASHERS AND NUTS USED ON GROUNDING CONNECTIONS SHALL BE STAINLESS STEEL.

ALL EXTERIOR GROUND BARS SHALL BE COATED WITH ANTI-CORROSIVE AGENT SUCH AS LPS-3 OR AS PER NOTE 6 ABOVE.

ALL JUNCTION AND OUTLET BOXES TO BE LABELED WITH KROY TAPE, OR EQUAL, DESIGNATING ALL CIRCUIT NUMBERS CONTAINED IN EACH BOX.

CONTRACTOR TO ENSURE ILC PROVIDED WITH (2) INTERNAL TVSS.

CONTRACTOR SHALL COORDINATE WITH SITE SURVEY TO LOCATE EXISTING UNDERGROUND UTILITIES. WHEREVER POTENTIAL CONFLICTS/ INTERFERENCES EXIST, HAND EXCAVATE TO AVOID DAMAGE. CONTACT ALL UTILITIES TO LOCATE UNDERGROUND PIPING IN PUBLIC ROW.

VERIFY THAT A.I.C. OF THE UTILITY DOES NOT EXCEED THE A.I.C. RATING OF THE PROVIDED EQUIPMENT SHELTER PACKAGE. IF OVER 10KAC, PROVIDE FUSIBLE SERVICE ENTRANCE SWITCH AND CONFIRM LOWERING OF AG TO ACCEPTABLE LEVELS.

UTILITY POINTS OF SERVICE AND WORK / MATERIALS SHOWN ARE BASED UPON PRELIMINARY INFORMATION PROVIDED BY THE UTILITY COMPANIES AND ARE FOR BID PURPOSES ONLY.

CONTRACTOR SHALL COORDINATE WITH UTILITY COMPANY FOR FINAL AND EXACT WORK / MATERIALS REQUIREMENTS AND CONSTRUCT TO UTILITY COMPANY ENGINEERING PLANS AND SPECIFICATIONS ONLY. CONTRACTOR SHALL FURNISH AND INSTALL ALL CONDUIT, PULL ROPE/S, CABLES, PULL BOXES, CONCRETE ENCASMENT OF CONDUIT (IF REQUIRED), TRANSFORMER PAD, BARRIERS, FENCE LINE/S, TELEPHONE BACKBILL, PAY ALL UTILITY COMPANY FEES AND INCLUDE ALL REQUIREMENTS IN SCOPE OF WORK.

GROUNDING NOTES:

1. ALL ELECTRICAL WORK SHALL BE PERFORMED IN ACCORDANCE WITH THE DESIGN AND CONSTRUCTION SPECIFICATIONS AND ALL APPLICABLE LOCAL CODES.
2. CONDUIT ROUTINGS ARE SCHEMATIC. CONTRACTOR SHALL INSTALL CONDUITS SO THAT ACCESS TO EQUIPMENT IS NOT BLOCKED.
3. THE CONTRACTOR IS RESPONSIBLE FOR PROPERLY SEQUENCING GROUNDING AND UNDERGROUND CONDUIT INSTALLATION AS TO PREVENT ANY LOSS OF CONTINUITY IN THE GROUNDING SYSTEM OR DAMAGE TO THE CONDUIT.
4. ALL GROUND CONNECTIONS BELOW GRADE SHALL BE EXOTHERMIC (CADWELD).
5. ALL GROUND CONNECTIONS ABOVE GRADE (INTERIOR & EXTERIOR) SHALL BE FORMED USING TWO (2) HIGH PRESS CRIMPS, UNLESS NOTED OTHERWISE.
6. ALL EXOTHERMIC CONNECTIONS TO THE GROUND RODS SHALL START AT THE TOP & HAVE A VERTICAL SEPARATION OF 6" FOR EVERY ADDITIONAL CONNECTION. RESISTANT MATERIAL.
7. ALL EXTERIOR GROUND CONNECTIONS SHALL BE COATED WITH A CORROSION RESISTANT MATERIAL.
8. ALL EXTERIOR GROUND CONDUCTORS SHALL BE #2 AWG SOLID TIN PLATED COPPER UNLESS OTHERWISE INDICATED.
9. GROUND RODS SHALL BE STAINLESS STEEL OR COPPER CLAD STEEL, 5/8"Ø 10-FT. LONG (OR NOTED OTHERWISE ON PLANS), AND SHALL BE DRIVEN VERTICALLY WITH THEIR TOPS 30" BELOW FINAL GRADE OR 6" BELOW FROST LINE FOR MAXIMUM DEPTH.
10. CONNECTIONS TO THE GROUND BUS SHALL NOT BE DOUBLED UP OR STACKED. PERMITTED BACK CONNECTIONS ON OPPOSITE SIDES OF THE GROUND BUS ARE PERMITTED.
11. USE OF 90° BENDS IN THE PROTECTION GROUNDING CONDUCTORS SHALL BE AVOIDED WHEN 45° BENDS CAN BE ADEQUATELY SUPPORTED.
12. GROUND RING SHALL BE LOCATED A MINIMUM OF 30" BELOW GRADE OR 6" MINIMUM BELOW THE FROST LINE.
13. INSTALL GROUND CONDUCTORS AND GROUND ROD MINIMUM OF 1'-0" FROM EQUIPMENT CONCRETE PAD, SPREAD FOOTING, OR FENCE.
14. EXOTHERMIC WELD GROUND CONNECTION TO FENCE POST: TREAT WITH A COLD GALVANIZED SPRAY.
15. OBSERVE N.E.C. AND LOCAL UTILITY REQUIREMENTS FOR ELECTRICAL SERVICE GROUNDING
16. GROUNDING ATTACHMENT TO TOWER SHALL BE AS PER MANUFACTURER'S RECOMMENDATIONS OR AT GROUNDING POINTS PROVIDED (2 MINIMUM)
17. MAXIMUM RESISTANCE OF THE COMPLETED GROUND SYSTEM SHALL NOT EXCEED 5 OHMS.
18. CONTRACTOR TO VERIFY CURRENT GROUNDING STANDARDS PRIOR TO CONSTRUCTION.

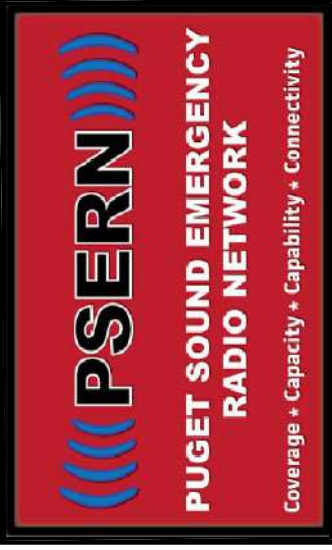

SWAN
(NEW BUILD)

39025 NE NORTH FORK RD.
DUVALL, WA 98019

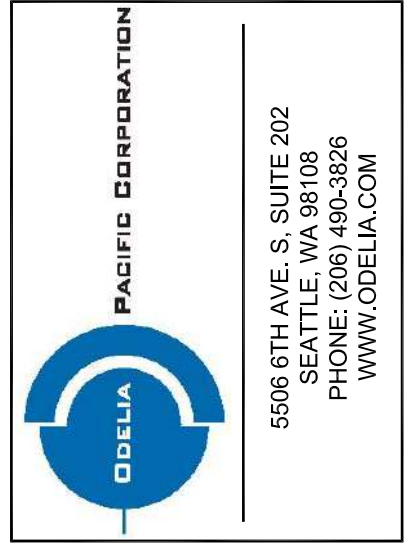

PROJECT MANAGER: EJC

PREPARED BY: AJO/EAT

APPROVED BY: PN

▲	07/31/17	UPDATED SURVEY
▲	07/21/17	DPER COMMENTS
▲	06/27/17	ELECTRICAL TIE-IN W/ SCL
▲	06/15/17	ISSUED FOR PERMIT

PLAN REVIEWERS SIGNATURE

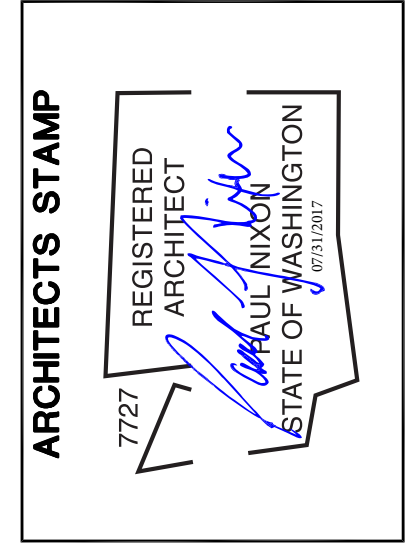

SHEET NAME

GENERAL NOTES

SHEET NUMBER
SP-1

1 - **GENERAL NOTES**

SWAN
(NEW BUILD)
39025 NE NORTH FORK RD.
DUVALL, WA 98019

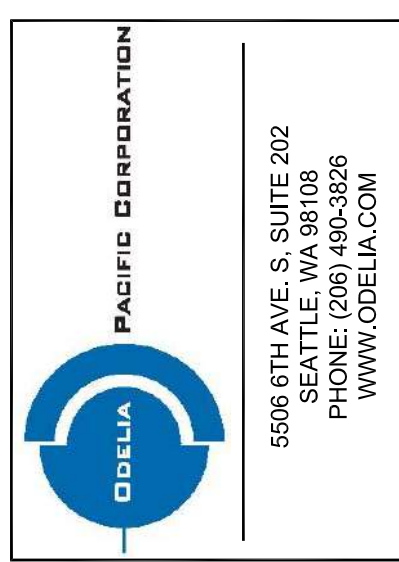

DELLA PACIFIC CORPORATION
5906 6TH AVE S, SUITE 202
SEATTLE, WA 98108
PHONE: (206) 490-3825
WWW.DODELIA.COM



CAMP+ ASSOCIATES
19401 40TH AVE. W, SUITE 304
LYNNWOOD, WA 98036
PHONE: (425) 740-6392
FAX: (425) 252-2860
WWW.CAMPASSOC.COM

PROJECT MANAGER: EJC

PREPARED BY: AJO/EAT

APPROVED BY: PN

07/31/17	UPDATED SURVEY
07/21/17	DPER COMMENTS
06/27/17	ELECTRICAL TIE-IN W/ SCL
06/15/17	ISSUED FOR PERMIT

PLAN REVIEWERS SIGNATURE

ARCHITECTS STAMP
7727
REGISTERED ARCHITECT
STATE OF WASHINGTON
JACOB NIXON
11/01/2017

SHEET NAME
SPECIAL INSPECTIONS

SHEET NUMBER
SP-2

TABLE 1705.3
REQUIRED SPECIAL INSPECTIONS AND TESTS OF CONCRETE CONSTRUCTION

TYPE	CONTINUOUS SPECIAL INSPECTION	PERIODIC SPECIAL INSPECTION	REFERENCED STANDARD	IBC REFERENCE
1. INSPECT REINFORCEMENT, INCLUDING PRESTRESSING TENDONS, AND VERIFY PLACEMENT.	-	X	ACI 318, CH. 20, 25.2, 25.3, 26.6.1-26.6.3	1908.4
2. REINFORCING BAR WELDING: A. VERIFY WELDABILITY OF REINFORCING BARS OTHER THAN ASTM A706; B. INSPECT SINGLE-PASS FILLET WELDS, MAXIMUM 5/16"; AND C. INSPECT ALL OTHER WELDS.	-	X	AMS D1.4 ACI 318: 26.6.4	-
3. INSPECT ANCHORS IN CAST CONCRETE.	-	X	ACI 318: 17.8.2	-
4. INSPECT ANCHORS POST-INSTALLED IN HARDENED CONCRETE MEMBERS. A. ADHESIVE ANCHORS INSTALLED IN HORIZONTALLY OR UPWARDLY INCLINED ORIENTATIONS TO RESIST SUSTAINED TENSION LOADS. B. MECHANICAL ANCHORS AND ADHESIVE ANCHORS NOT DEFINED IN 4.A.	X	-	ACI 318: 17.8.2.4	-
5. VERIFY USE OF REQUIRED DESIGN MIX.	-	X	ACI 318: CH. 19, 26.4.3, 26.4.4	1904.1, 1904.2, 1908.2, 1908.3
6. PRIOR TO CONCRETE PLACEMENT, FABRICATE SPECIMENS FOR STRENGTH TESTS, PERFORM SLUMP AND AIR CONTENT TESTS, AND DETERMINE TEMPERATURE OF THE CONCRETE.	X	-	ASTM C177 ASTM C178 ACI 318: 26.4, 26.12	1908.10
7. INSPECT CONCRETE AND SHOTCRETE PLACEMENT FOR PROPER APPLICATION TECHNIQUES.	X	-	ACI 318: 26.5	1908.6, 1908.7, 1908.8
8. VERIFY MAINTENANCE OF SPECIFIED CURING TEMPERATURE AND TECHNIQUES.	-	X	ACI 318: 26.5.3-26.5.5	1908.9
9. INSPECT PRESTRESSED CONCRETE FOR: A. APPLICATION OF PRESTRESSING FORCES; AND B. GROUTING OF BONDED PRESTRESSING TENDONS.	X	-	ACI 318: 26.10	-
10. INSPECT ERECTION OF PRECAST CONCRETE MEMBERS.	-	X	ACI 318: 26.8	-
11. VERIFY IN-SITU CONCRETE STRENGTH, PRIOR TO STRESSING OF TENDONS IN POST-TENSIONED CONCRETE AND PRIOR TO REMOVAL OF SHORES AND FORMS FROM BEAMS AND STRUCTURAL SLABS.	-	X	ACI 318: 26.11.2	-
12. INSPECT FORMWORK FOR SHAPE, LOCATION AND DIMENSIONS OF THE CONCRETE MEMBER BEING FORMED.	-	X	ACI 318: 26.11.1.2	-

TABLE 1705.7
REQUIRED SPECIAL INSPECTIONS AND TESTS OF DRIVEN DEEP FOUNDATION ELEMENTS

TYPE	CONTINUOUS SPECIAL INSPECTION	PERIODIC SPECIAL INSPECTION
1. VERIFY ELEMENT MATERIALS, SIZES AND LENGTHS COMPLY WITH THE REQUIREMENTS.	X	-
2. DETERMINE CAPACITIES OF TEST ELEMENTS AND CONDUCT ADDITIONAL LOAD TESTS, AS REQUIRED.	X	-
3. INSPECT DRIVING OPERATIONS AND MAINTAIN COMPLETE AND ACCURATE RECORDS FOR EACH ELEMENT.	X	-
4. VERIFY PLACEMENT LOCATIONS AND PLUMBNESS. CONFIRM TYPE AND SIZE OF ANCHORS. VERIFY PENETRATIONS TO ACHIEVE DESIGN CAPACITY. RECORD TIP AND BUTT ELEVATIONS AND DOCUMENT ANY DAMAGE TO FOUNDATION ELEMENT.	X	-
5. FOR STEEL ELEMENTS, PERFORM ADDITIONAL SPECIAL INSPECTIONS IN ACCORDANCE WITH SECTION 1705.3.	-	-
6. FOR CONCRETE ELEMENTS AND CONCRETE-FILLED ELEMENTS, PERFORM TESTS AND ADDITIONAL SPECIAL INSPECTIONS IN ACCORDANCE WITH SECTION 1705.3.	-	-
7. FOR SPECIALTY ELEMENTS, PERFORM ADDITIONAL INSPECTIONS AS DETERMINED BY THE REGISTERED DESIGN PROFESSIONAL IN RESPONSIBLE CHARGE.	-	-

TABLE 1705.8
REQUIRED SPECIAL INSPECTIONS AND TESTS OF CAST-IN-PLACE DEEP FOUNDATION ELEMENTS

TYPE	CONTINUOUS SPECIAL INSPECTION	PERIODIC SPECIAL INSPECTION
1. INSPECT DRILLING OPERATIONS AND MAINTAIN COMPLETE AND ACCURATE RECORDS FOR EACH ELEMENT.	X	-
2. VERIFY PLACEMENT LOCATIONS AND PLUMBNESS. CONFIRM ELEMENT DIAMETERS, BELL DIAMETERS (IF APPLICABLE), LENGTHS, EMBEDMENT INTO BEDROCK (IF APPLICABLE), AND ADEQUATE END-BEARING STRATA CAPACITY. RECORD CONCRETE OR GROUT VOLUMES.	X	-
3. FOR CONCRETE ELEMENTS, PERFORM TESTS AND ADDITIONAL SPECIAL INSPECTIONS IN ACCORDANCE WITH SECTION 1705.3.	-	-

TABLE 1705.6
REQUIRED SPECIAL INSPECTIONS AND TESTS OF SOILS

TYPE	CONTINUOUS SPECIAL INSPECTION	PERIODIC SPECIAL INSPECTION
1. VERIFY MATERIALS BELOW SHALLOW FOUNDATIONS ARE ADEQUATE TO ACHIEVE THE DESIGN BEARING CAPACITY.	-	X
2. VERIFY EXCAVATIONS ARE EXTENDED TO PROPER DEPTH AND HAVE REACHED PROPER MATERIAL.	-	X
3. PERFORM CLASSIFICATION AND TESTING OF COMPACTED FILL MATERIALS.	-	X
4. VERIFY USE OF PROPER MATERIALS, DENSITIES AND LIFT THICKNESSES DURING PLACEMENT AND COMPACTION OF COMPACTED FILL.	X	-
5. PRIOR TO PLACEMENT OF COMPACTED FILL, INSPECT SUBGRADE AND VERIFY THAT SITE HAS BEEN PREPARED PROPERLY.	-	X

STEEL SPECIAL INSPECTIONS

AISC 360 - TABLE NS.6-1
INSPECTION TASKS PRIOR TO BOLTING

INSPECTION TASKS PRIOR TO BOLTING	QC	QA
INSPECTION TASKS PRIOR TO BOLTING	0	0
MANUFACTURER'S CERTIFICATIONS AVAILABLE FOR FASTENER MATERIALS	0	0
FASTENERS MARKED IN ACCORDANCE WITH ASTM REQUIREMENTS	0	0
PROPER FASTENERS SELECTED FOR THE JOINT DETAIL (GRADE, TYPE, BOLT LENGTH IF THREADS ARE TO BE EXCLUDED FROM SHEAR PLANE)	0	0
PROPER BOLTING PROCEDURE SELECTED FOR JOINT DETAIL	0	0
CONNECTING ELEMENTS, INCLUDING THE APPROPRIATE FAYING SURFACE CONDITION AND HOLE PREPARATION, IF SPECIFIED, MEET APPLICABLE REQUIREMENTS	0	0
PROPER STORAGE PROVIDED FOR BOLTS, NUTS, WASHERS AND OTHER FASTENER COMPONENTS	0	0

AISC 360 - TABLE NS.6-2
INSPECTION TASKS DURING BOLTING

INSPECTION TASKS DURING BOLTING	QC	QA
FASTENER ASSEMBLIES, OF SUITABLE CONDITION, PLACED IN ALL HOLES AND WASHERS (IF REQUIRED) ARE POSITIONED AS REQUIRED	0	0
JOINT BROUGHT TO THE SNUG-TIGHT CONDITION PRIOR TO THE PRETENSIONING OPERATION	0	0
FASTENER COMPONENT NOT TURNED BY THE WRENCH PREVENTED FROM ROTATING	0	0
FASTENERS ARE PRETENSIONED IN ACCORDANCE WITH RCSC SPECIFICATION, PROGRESSING SYSTEMATICALLY FROM THE MOST RIGID POINT TOWARD THE FREE EDGES	0	0

AISC 360 - TABLE NS.6-3
INSPECTION TASKS AFTER BOLTING

INSPECTION TASKS AFTER BOLTING	QC	QA
DOCUMENT ACCEPTANCE OR REJECTION OF BOLTED CONNECTIONS	P	P

QC = QUALITY CONTROL TASKS TO BE PERFORMED BY STEEL FABRICATOR OR ERECTOR.
QA = QUALITY ASSURANCE TASKS TO BE PERFORMED BY A SPECIAL INSPECTION AGENCY OR INDIVIDUALS DEFINED BY AWS B5.1 OR INDIVIDUALS QUALIFIED UNDER THE PROVISIONS OF AWS D1.1/01.1M SUBCLAUSE 6.1.4.
O = OBSERVE THESE ITEMS ON A RANDOM BASIS. OPERATIONS NEED NOT BE DELAYED PENDING THESE INSPECTIONS.
P = PERFORM THESE TASKS FOR EACH BOLTED CONNECTION.

IBC 1704.6
STRUCTURAL OBSERVATIONS

STRUCTURAL OBSERVATIONS FOR SEISMIC RESISTANCE - STRUCTURE IS CLASSIFIED AS RISK CATEGORY IV.
STRUCTURAL OBSERVATIONS FOR WIND REQUIREMENTS - STRUCTURE IS CLASSIFIED AS RISK CATEGORY IV.

SPECIAL INSPECTIONS:
SPECIAL INSPECTIONS IN ACCORDANCE WITH IBC 110 AND CH. 17 SHALL BE PERFORMED (AS REQUIRED) BY A QUALIFIED TESTING AGENCY APPROVED BY THE ARCHITECT/ENGINEER. INSPECTION AGENCY SHALL BE RETAINED BY THE PROJECT OWNER OR THEIR RESPONSIBLE CHARGE. THE ARCHITECT, ENGINEER OF RECORD, AND BUILDING DEPARTMENT SHALL RECEIVE COPIES OF ALL INSPECTION AND TEST RESULTS. REFER TO DOCUMENTS FOR SPECIFIC INFORMATION.

P SERN - SWAN

SW 1/4, SEC. 29, T 26 N, R 8 E, W.M. KING COUNTY, WASHINGTON

SERVIENT PARCEL DESCRIPTION

SEVIER NATIONAL TITLE OF WASHINGTON, INC. / ESCROW NO. 20371586-410-120 / EFFECTIVE DATE: JULY 10, 2015 AT 8:00 A.M.

THOSE PORTIONS OF SECTIONS 29, 30, 31 AND 32, TOWNSHIP 26 NORTH, RANGE 8 EAST, W.M., IN KING COUNTY, WASHINGTON, LING SOUTHERLY OF THE SOUTHERLY LINE OF THAT TRACT OF LAND CONVEYED TO THE CITY OF SEATTLE BY DEED RECORDED UNDER RECORDING NUMBER 489789, EASTERLY OF THE THREAD OF THE STOSSEL CREEK, NORTHERLY OF THE THREAD OF THE TOLT RIVER, NORTHERLY AND NORTHWESTERLY OF THE THREAD OF THE NORTH FORK OF THE TOLT RIVER AND WESTERLY OF THE THREAD OF NORTH FORK CREEK.

SITUATE IN THE COUNTY OF KING, STATE OF WASHINGTON.

TITLE EXCEPTIONS

TITLE EXCEPTIONS AS SHOWN ON SCHEDULE B - SECTION 2

FIDELITY NATIONAL TITLE OF WASHINGTON, INC. / ESCROW NO. 20371586-410-120 / EFFECTIVE DATE: JULY 10, 2015 AT 8:00 A.M.

- SUBJECT TO AN EASEMENT AND THE TERMS AND CONDITIONS THEREOF DISCLOSED BY BOUNDARY SURVEY FROM PARCEL ACCESS, RECORDING NUMBER 9112028014, AND DEED ON CONVEYANCE FROM PARCEL ACCESS, RECORDING NUMBER 9112028014, (NOT PLOTTABLE).
- SUBJECT TO AN EASEMENT AND THE TERMS AND CONDITIONS THEREOF GRANTED FOR THE CONVEYANCE OF PARCEL ACCESS, RECORDING NUMBER 9112028014, (NOT PLOTTABLE).
- SUBJECT TO THE RIGHT OF THE STATE OF WASHINGTON IN AND TO THAT PORTION OF ANY OF THE LAND HEREIN DESCRIBED WHICH LIES BELOW THE LINE OF ORDINARY HIGH WATER OF STOSSEL CREEK, TOLT RIVER, NORTH FORK OF THE TOLT RIVER AND NORTH FORK CREEK. (NOT PLOTTABLE)
- SUBJECT TO ANY CHANGE IN THE BOUNDARY OR LEGAL DESCRIPTION OF THE LAND DESCRIBED HEREIN, DUE TO A SHIFT OR CHANGE IN THE COURSE OF STOSSEL CREEK, TOLT RIVER, NORTH FORK TOLT RIVER AND NORTH FORK CREEK. (NOT PLOTTABLE)
- SUBJECT TO RIGHTS AND EASEMENTS OF THE PUBLIC FOR COMMERCE, NAVIGATION, RECREATION AND FISHERIES. (NOT PLOTTABLE)
- SUBJECT TO ANY RESTRICTIONS ON THE USE OF THE LAND RESULTING FROM THE RIGHTS OF NEIGHBORS TO USE ANY PORTION WHICH IS NOW OR HAS BEEN COVERED BY WATER. (NOT PLOTTABLE)
- SUBJECT TO UNRECORDED LEASEHOLDS, IF ANY, RIGHTS OF VENDORS AND HOLDERS OF TENANTS TO REMOVE TRADE FIXTURES AT THE EXPIRATION OF THE TERM. (NOT PLOTTABLE)
- SUBJECT TO MATTERS RELATING TO THE QUESTIONS OF SURVEY, RIGHTS OF PARTIES IN INTEREST, AND THE DETERMINATION OF THE CORRECT LOCATION OF THE CORNERS AND DISPOSITION OF WHICH WILL BE FURNISHED BY SUPPLEMENTAL REPORT. (NOT PLOTTABLE)

LEASE AREA DESCRIPTION

A PORTION OF SECTION 29, TOWNSHIP 26 NORTH, RANGE 8 EAST, W.M., IN KING COUNTY, WASHINGTON IS BEING MORE PARTICULARLY DESCRIBED AS FOLLOWS:

COMMENCING AT THE WESTERLY QUARTER CORNER OF SAID SECTION 29;

THENCE NORTH 89°04'17" EAST, ALONG THE WEST LINE OF SAID SECTION TO THE BEGINNING OF A NON-TANGENT CURVE TO THE LEFT FROM WHICH THE CENTER OF SAID CURVE IS A DISTANCE OF 287.00 FEET THROUGH A CENTRAL ANGLE OF 82°72'24" THENCE NORTH 25°02'57" EAST, A DISTANCE OF 780.59 FEET TO A CONCRETE MONUMENT;

THENCE SOUTH 12°59'18" EAST, A DISTANCE OF 135.59 FEET TO THE POINT OF BEGINNING;

THENCE SOUTH 10°54'37" EAST, A DISTANCE OF 77.00 FEET;

THENCE NORTH 10°54'37" WEST, A DISTANCE OF 77.00 FEET;

THENCE NORTH 79°02'57" EAST, A DISTANCE OF 104.00 FEET TO THE POINT OF BEGINNING.

ACCESS & UTILITY EASEMENT DESCRIPTION

TO BE DETERMINED AFTER REVIEW.

SURVEYOR'S NOTES

- TITLE REPORT ISSUED BY FIDELITY NATIONAL TITLE OF WASHINGTON, INC. / ESCROW NO. 20371586-410-120 / EFFECTIVE DATE: JULY 10, 2015 AT 8:00 A.M.
- LATITUDE AND LONGITUDE TAKEN AT PROPOSED TOWER.
- MAGNETIC NORTH RECOMPUTATION OF APPROXIMATELY 15.98° E FOR THE DATE OF 9-15-15, COMPUTED BY USING THE MAGNETIC FIELD CALCULATOR ON THE NOAA NATIONAL GEOPHYSICAL DATA CENTER WEBSITE AND DOES NOT ACCOUNT FOR ANY LOCAL VARIATION OR ANOMALY.

UTILITY NOTES

THE LOCATION OF EXISTING UTILITY FACILITIES WAS NOT BEEN RESEARCHED. SURVEYOR DOES NOT GUARANTEE THAT ALL UTILITIES ARE SHOWN OF THEIR LOCATIONS. IT IS THE RESPONSIBILITY OF THE CONTRACTOR TO VERIFY THE LOCATION OF UTILITIES ON THE GROUND. THE SURVEYOR HAS AND/OR REPLACES TO THE BEST OF HIS KNOWLEDGE AND BELIEF THE LOCATION AND/OR REPLACEMENT OF SUCH UTILITIES. THE SURVEYOR ASSUMES NO RESPONSIBILITY FOR THE DETERMINATION OF SUCH UNDERGROUND UTILITIES, NOR FOR THE EXISTENCE OF BURIED OBJECTS WHICH ARE NOT SHOWN ON THE MAP.

BOUNDARY DISCLAIMER

THIS SURVEY HAS BEEN PREPARED FOR THE EXCLUSIVE USE OF PARTIES WHOSE NAMES APPEAR HEREON ONLY, AND DOES NOT EXTEND TO ANY UNNAMED THIRD PARTIES WITHOUT EXPRESS RECONVEYANCE BY THE LAND SURVEYOR.

BOUNDARY LINES SHOWN AND CORNERS SET REPRESENT DEED LOCATIONS; OWNERSHIP LINES MAY VARY. NO GUARANTEE OF OWNERSHIP IS EXPRESSED OR IMPLIED.

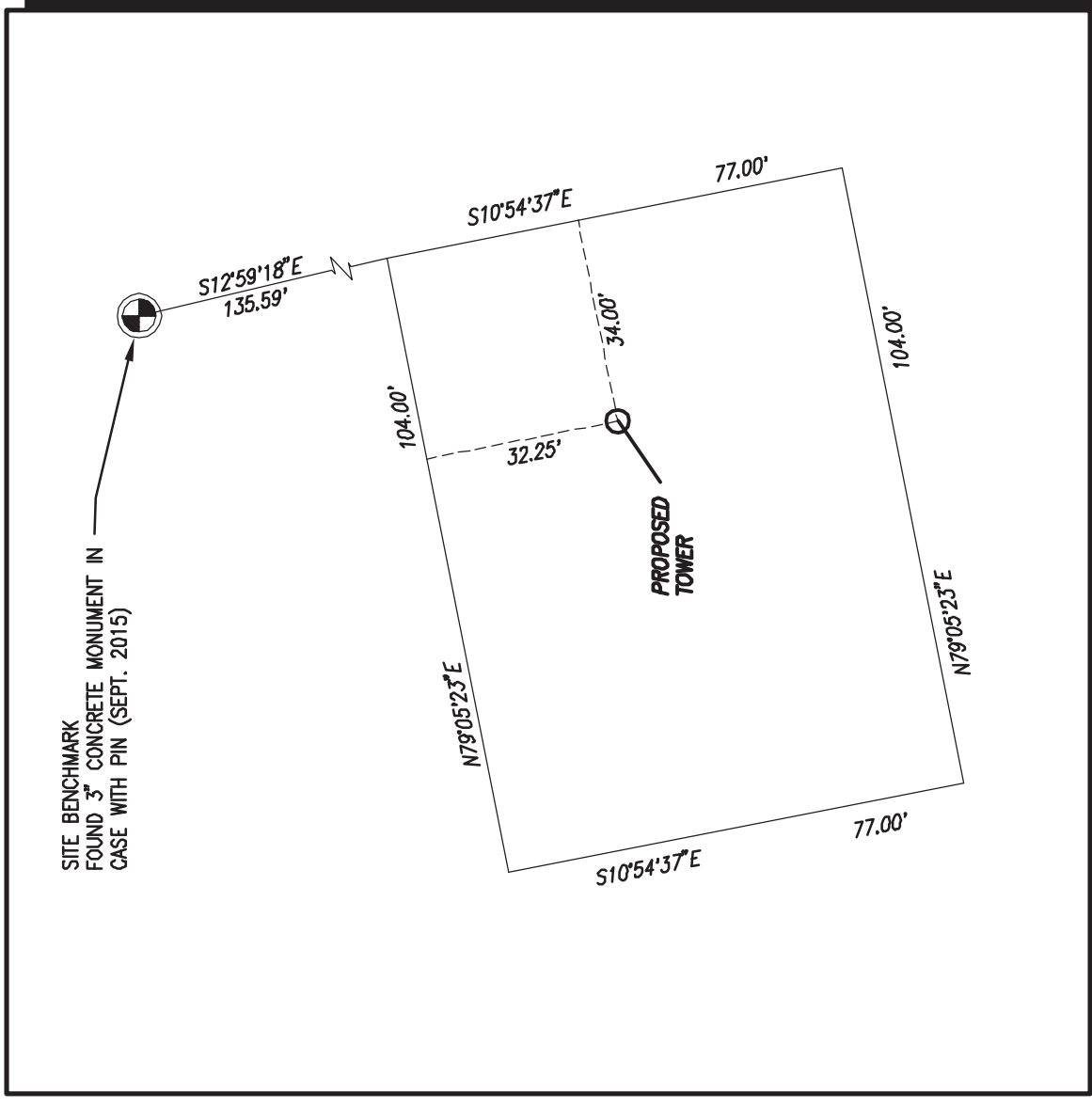
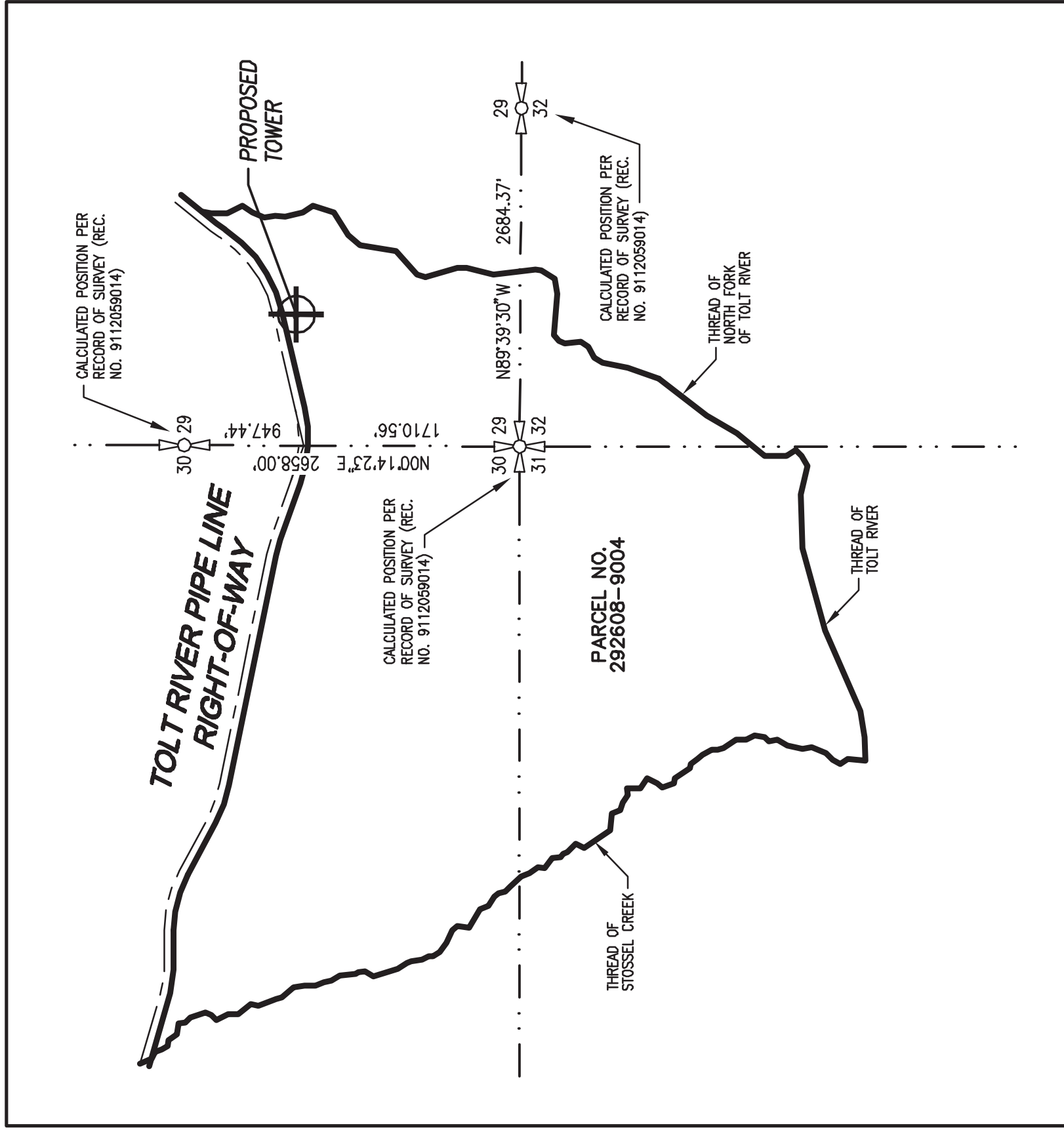

PROJECT INFORMATION

SITE NAME:	P SERN - SWAN	GROUND ELEVATION:	689' (CENTER OF PROPOSED TOWER)
SITE ADDRESS:	39025 NE NORTH FORK RD DUVALL, WA 98019	SITE BENCHMARK:	FOUND 3" CONCRETE MONUMENT IN CASE WITH PIN (AS SHOWN ON PLAN) ELEV. = 689.68
OWNER'S NAME:	SEATTLE CITY OF (SPU)	VERTICAL DATUM:	NAVD 88 BASED ON GPS OBSERVATION
OWNER'S ADDRESS:	N/A	BASES OF BEARINGS:	WASHINGTON STATE PLANE, NORTH ZONE, MAG 83
PARCEL NUMBER(S):	292608-9004	PROJECT LEASE AREA:	5,008 SF
PROPOSED TOWER COORDINATES:	47422.79' N 12149017.6' W (47706608' N) (121817156' W)		

BASIS OF BEARING

ELEVATION ESTABLISHED FROM GPS DERIVED ORTHOMETRIC HEIGHTS, APPLYING GEOID OR SEPARATIONS USING WSON SOLUTION. ACCURACY MEETS OR EXCEEDS IN STANDARDS AS DEFINED ON THE PM 1056 INFORMATION SHEET 91003.

SURVEY DATE

SEPTEMBER 8, 2015

LEGEND

- PP POWER POLE
- WM WATER MAIN
- WM WATER METER
- WM WATER VALVE
- ET EXISTING BUILDING
- ET EXISTING TREE
- ET EXISTING CONIFEROUS TREE
- ET EXISTING DECIDUOUS TREE
- ET EXISTING FIRE HYDRANT

TREE TABLE

NUMBER	DIAMETER	TYPE	HEIGHT
16	4"	ALDER	35'
17	4"	ALDER	35'
18	12"	MAPLE	45'
19	8"	MAPLE	45'
20	4"(2)	MAPLE	30'
21	12"	MAPLE	40'
22	12"	ALDER	40'
23	12"	ALDER	30'
24	8"	ALDER	35'
25	24"	FIR	121'
26	24"	CEDAR	118'
27	24"	CEDAR	118'
28	36"	CEDAR	118'
29	12"	FIR	130'
30	24"	FIR	119'

TREE TABLE

NUMBER	DIAMETER	TYPE	HEIGHT
1	8"	ALDER	40'
2	8"	ALDER	45'
3	8"	ALDER	40'
4	6"	ALDER	30'
5	12"	FIR	45'
6	10'(6)	ALDER	35'
7	10'(2)	ALDER	35'
8	10"	ALDER	35'
9	10"	ALDER	35'
10	12"	ALDER	45'
11	12'(2)	ALDER	45'
12	12"	MAPLE	45'
13	4'(5)	ALDER	35'
14	10'(2)	ALDER	40'
15	8"	MAPLE	40'

BOUNDARY DETAIL

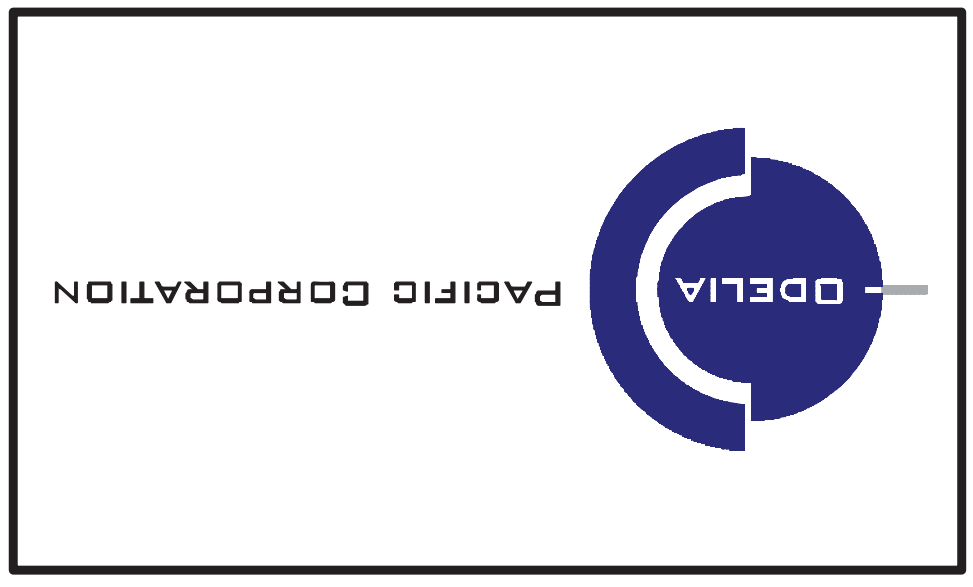
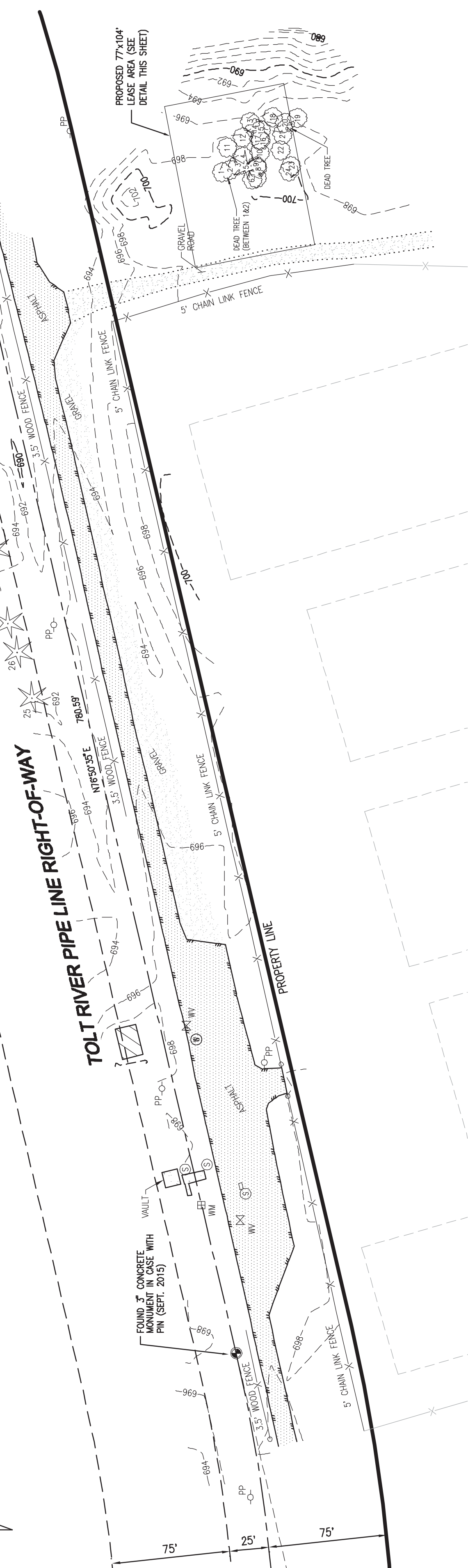
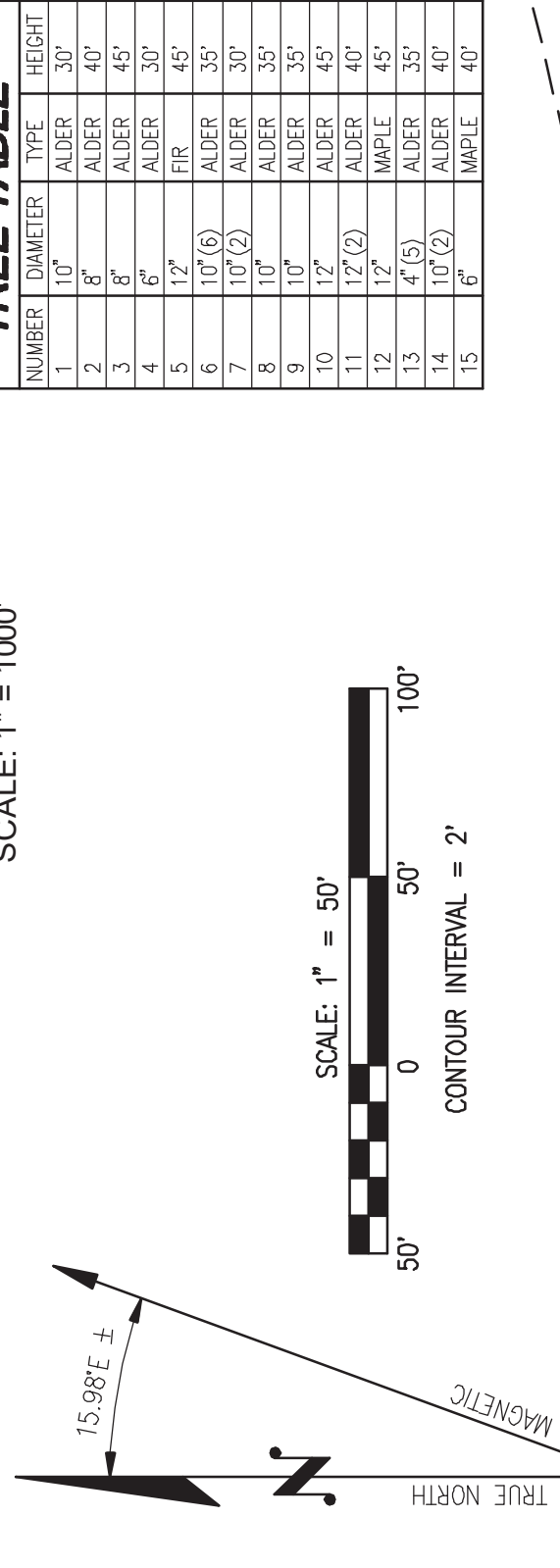

LDC Architectural Engineering Structural Survey

THE CIVIL ENGINEERING GROUP
Woodinville, WA 98072
Ph. 425.805.1889
Fax. 425.482.2893
www.LDCcorp.com

DATE: 9-15-15
DRAWN BY: VJT
CHECKED BY: MRM

REVISIONS

REV	DATE	DESCRIPTION	BY
1	5-16-17	SURVEY	COO
2	7-18-17	REVISE LEASE AREA	MFM
3	7-21-17	REVISE LEASE AREA	MFM

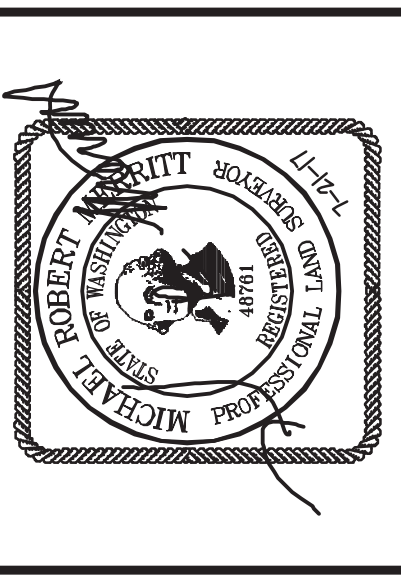

SITE
P SERN
SWAN
NE NORTH FORK ROAD
DUVALL, WA

SHEET TITLE
CIVIL SURVEY

SHEET NUMBER
SV-1.0



SWAN
(NEW BUILD)
39025 NE NORTH FORK RD.
DUWALL WA 98019

DBELIA PACIFIC CORPORATION
5906 6TH AVE. S. SUITE 202
SEATTLE, WA 98108
PHONE: (206) 490-3826
WWW.DBELIA.COM

ENGINEERING
250 4TH AVE. S. SUITE 200
EDMONDS, WASHINGTON 98020
PHONE (425) 778-8500
FAX (425) 778-5536
CG PROJECT# 16015.917

PROJECT MANAGER VD

PREPARED BY ZOS

APPROVED BY JPU

REV	DATE	DESCRIPTION
△	07/29/17	PERMIT RESUBMITTAL
△	05/08/17	PERMIT RESUBMITTAL
△	10/10/16	PERMIT SUBMITTAL

PLAN REVIEWERS SIGNATURE

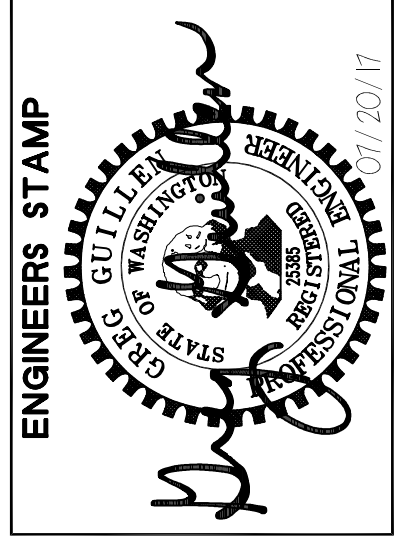

SHEET NAME
TEMPORARY EROSION CONTROL PLAN

SHEET NUMBER
C2.1

EROSION CONTROL NOTES

- APPROVAL OF THIS EROSION AND SEDIMENTATION CONTROL (ESC) PLAN DOES NOT CONSTITUTE AN APPROVAL OF PERMANENT ROAD OR DRAINAGE DESIGN (E.G., SIZE AND LOCATION OF ROADS, PIPES, RESTRICTORS, CHANNELS, RETENTION FACILITIES, UTILITIES, ETC.).
- THE IMPLEMENTATION OF THESE ESC PLANS AND THE CONSTRUCTION MAINTENANCE AND MONITORING OF THESE ESC FACILITIES IS THE RESPONSIBILITY OF THE APPLICANT/ESC SUPERVISOR UNTIL ALL CONSTRUCTION IS APPROVED.
- THE BOUNDARIES OF THE CLEARING LIMITS SHOWN ON THIS PLAN SHALL BE CLEARLY FLAGGED BY SURVEY TAPE OR FENCING. IF REQUIRED, PRIOR TO CONSTRUCTION (SWDM APPENDIX D). DURING THE CONSTRUCTION PERIOD, NO DISTURBANCE BEYOND THE CLEARING LIMITS SHALL BE PERMITTED. THE CLEARING LIMITS SHALL BE MAINTAINED BY THE APPLICANT/ESC SUPERVISOR FOR THE DURATION OF CONSTRUCTION.
- STABILIZED CONSTRUCTION ENTRANCES SHALL BE INSTALLED AT THE BEGINNING OF CONSTRUCTION AND MAINTAINED FOR THE DURATION OF THE PROJECT. AFTER CONSTRUCTION IS COMPLETE, ALL CONSTRUCTION AREAS SHALL BE KEPT CLEAN AND TRACK OUT TO ROAD RIGHT OF WAY DOES NOT OCCUR FOR THE DURATION OF THE PROJECT.
- THE ESC FACILITIES SHOWN ON THIS PLAN MUST BE CONSTRUCTED PRIOR TO OR IN CONJUNCTION WITH ALL CLEARING AND GRADING SO AS TO ENSURE THAT THE TRANSPORT OF SEDIMENT TO SURFACE WATERS, DRAINAGE SYSTEMS, FLOW CONTROL BMP LOCATIONS (EXISTING AND PROPOSED), AND ADJACENT PROPERTIES IS MINIMIZED.
- THE ESC FACILITIES SHOWN ON THIS PLAN ARE THE MINIMUM REQUIREMENTS FOR ANTICIPATED SITE CONDITIONS. DURING THE CONSTRUCTION PERIOD, THESE ESC FACILITIES SHALL BE MAINTAINED AND MODIFIED TO ACCOUNT FOR CHANGING SITE CONDITIONS (E.G. ADDITIONAL COVER MEASURES, ADDITIONAL SUMP PUMPS, RELOCATION OF DITCHES AND SILT FENCES, PERIMETER PROTECTION ETC.) AS DIRECTED BY KING COUNTY.
- THE ESC FACILITIES SHALL BE INSPECTED DAILY BY THE APPLICANT/ESC SUPERVISOR AND MAINTAINED TO ENSURE CONTINUED PROPER FUNCTIONING. WRITTEN RECORDS SHALL BE KEPT OF WEEKLY REVIEWS OF THE ESC FACILITIES.
- ANY AREAS OF EXPOSED SOILS, INCLUDING ROADWAY EMBANKMENTS, THAT WILL NOT BE DISTURBED FOR TWO CONSECUTIVE DAYS DURING THE WET SEASON OR SEVEN DAYS DURING THE DRY SEASON SHALL BE IMMEDIATELY STABILIZED WITH THE APPROVED ESC METHODS (E.G., SEEDING, MULCHING, AND COVERING ETC.).
- ANY AREA MEETING ESC MEASURES THAT DO NOT REQUIRE IMMEDIATE ATTENTION SHALL BE ADDRESSED WITHIN SEVEN (7) DAYS.
- THE ESC FACILITIES ON INACTIVE SITES SHALL BE INSPECTED AND MAINTAINED A MINIMUM OF ONCE A MONTH DURING THE DRY SEASON, BI-MONTHLY DURING THE WET SEASON, OR WITHIN TWENTY FOUR (24) HOURS FOLLOWING A STORM EVENT.
- AT NO TIME SHALL MORE THAN ONE (1) FOOT OF SEDIMENT BE ALLOWED TO ACCUMULATE WITHIN A CATCH BASIN. ALL CATCH BASINS AND CONVEYANCE LINES SHALL BE CLEANED PRIOR TO PAVING. THE CLEANING OPERATION SHALL NOT FLUSH SEDIMENT-LADEN WATER INTO THE DOWNSTREAM SYSTEM.
- ANY PERMANENT RETENTION/DETENTION FACILITY USED AS A TEMPORARY EROSION CONTROL MEASURE SHALL PROVIDE ADEQUATE STORAGE CAPACITY. IF THE FACILITY IS TO FUNCTION ULTIMATELY AS AN INFILTRATION SYSTEM, THE TEMPORARY FACILITY MUST BE ROUGH GRADED SO THAT THE BOTTOM AND SIDES ARE AT LEAST THREE FEET ABOVE THE FINAL GRADE OF THE PERMANENT FACILITY. FLOW CONTROL BMP AREAS (EXISTING OR PROPOSED) SHALL NOT BE USED AS TEMPORARY FACILITIES AND SHALL BE PROTECTED FROM SEDIMENTATION AND INTRUSION.
- COVER MEASURES WILL BE APPLIED IN CONFORMANCE WITH APPENDIX D OF THE KING COUNTY SURFACE WATER DESIGN MANUAL.
- PRIOR TO THE BEGINNING OF THE WET SEASON (OCT. 1), ALL DISTURBED AREAS SHALL BE SEEDING AND MULCHING. DISTURBED AREAS SHALL BE SEEDING WITHIN ONE WEEK FOR THE WINTER BANS. DISTURBED AREAS SHALL BE SEEDING WITHIN ONE WEEK OF THE BEGINNING OF THE WET SEASON. A SKETCH MAP OF THOSE AREAS TO BE SEEDING AND THOSE AREAS TO REMAIN UNCOVERED SHALL BE SUBMITTED TO THE DPR INSPECTOR.

SUGGESTED TEMPORARY EROSION CONTROL BMPs

REFER TO APPENDIX D OF THE KING COUNTY SURFACE WATER DESIGN MANUAL FOR BMP DETAILS AND FOR ADDITIONAL BMP MEASURES. BMP NUMBERING FOR ESC PLAN REFERS TO 2012 DEPARTMENT OF ECOLOGY MANUAL, VOLUME II, SECTION 4

1. PLASTIC OR METAL FENCE (BMP C103)
2. NETS & BLANKETS (BMP C121)
3. TEMPORARY & PERMANENT SEEDING (BMP C122)
4. PLASTIC COVERING (BMP C123)
5. SILT FENCE (BMP C233)
6. MULCHING (BMP C121)
7. STABILIZED CONSTRUCTION ENTRANCE (BMP C105)
8. DUST CONTROL (BMP C140)
9. CONCRETE HANDLING (BMP C151)
10. STORM DRAIN INLET PROTECTION (BMP C220)

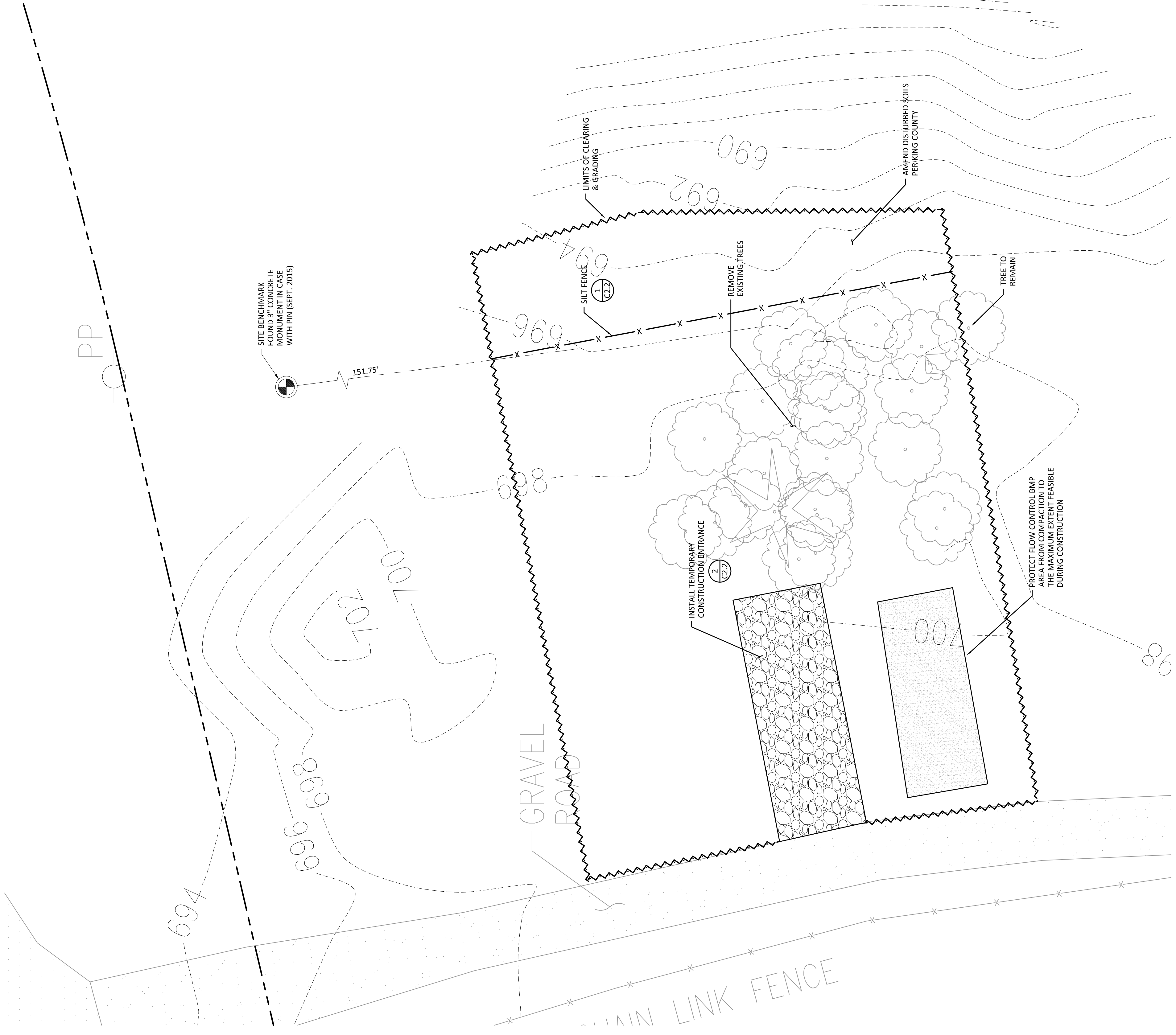

1 TEMPORARY EROSION CONTROL PLAN
SCALE: 1" = 10'

REV	DATE	DESCRIPTION
△	07/29/17	PERMIT RESUBMITTAL
△	05/08/17	PERMIT RESUBMITTAL
△	10/10/16	PERMIT SUBMITTAL

PLAN REVIEWERS SIGNATURE

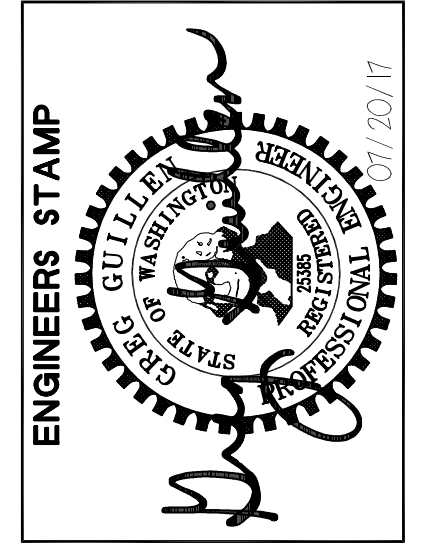

SHEET NAME
GRADING AND DRAINAGE PLAN

SHEET NUMBER
C3.1

FLOW CONTROL BMP(S):
1. GRAVEL FILLED INFILTRATION TRENCH FOR LID PERFORMANCE STANDARD PER SECTION C.2.2.3 OF THE 2016 KING COUNTY SURFACE WATER DESIGN MANUAL

GRADING QUANTITIES	
TOTAL EXCAVATION (CUT) -	15 CU YDS TOTAL
EMBANKMENT (FILL) -	50 CU YDS
TOTAL	65 CU YDS

THE QUANTITIES SHOWN ABOVE ARE FOR THE PERMIT PROCESS ONLY. THESE VALUES ARE APPROXIMATE. DO NOT USE FOR BIDDING, PAYMENT, OR ESTIMATING PURPOSES.

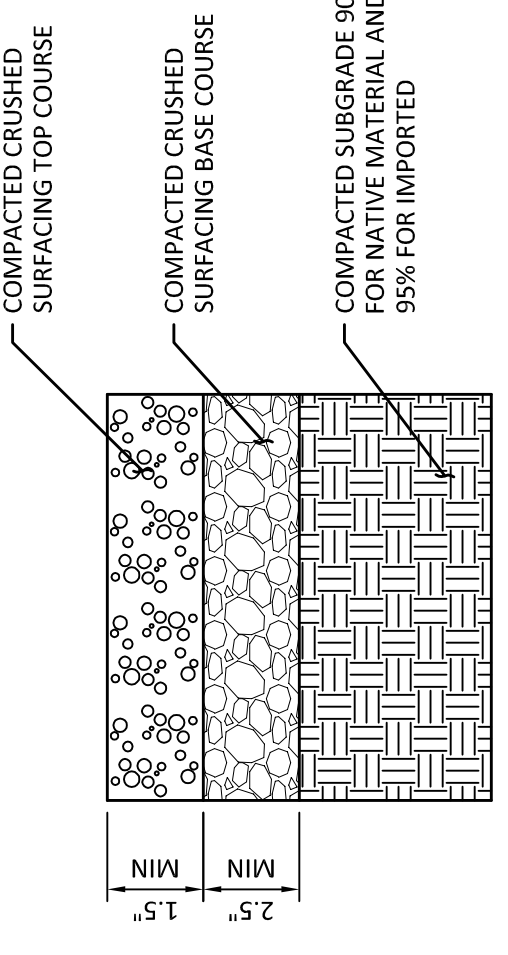

2 GRAVEL PAVING DETAIL
SCALE: NTS

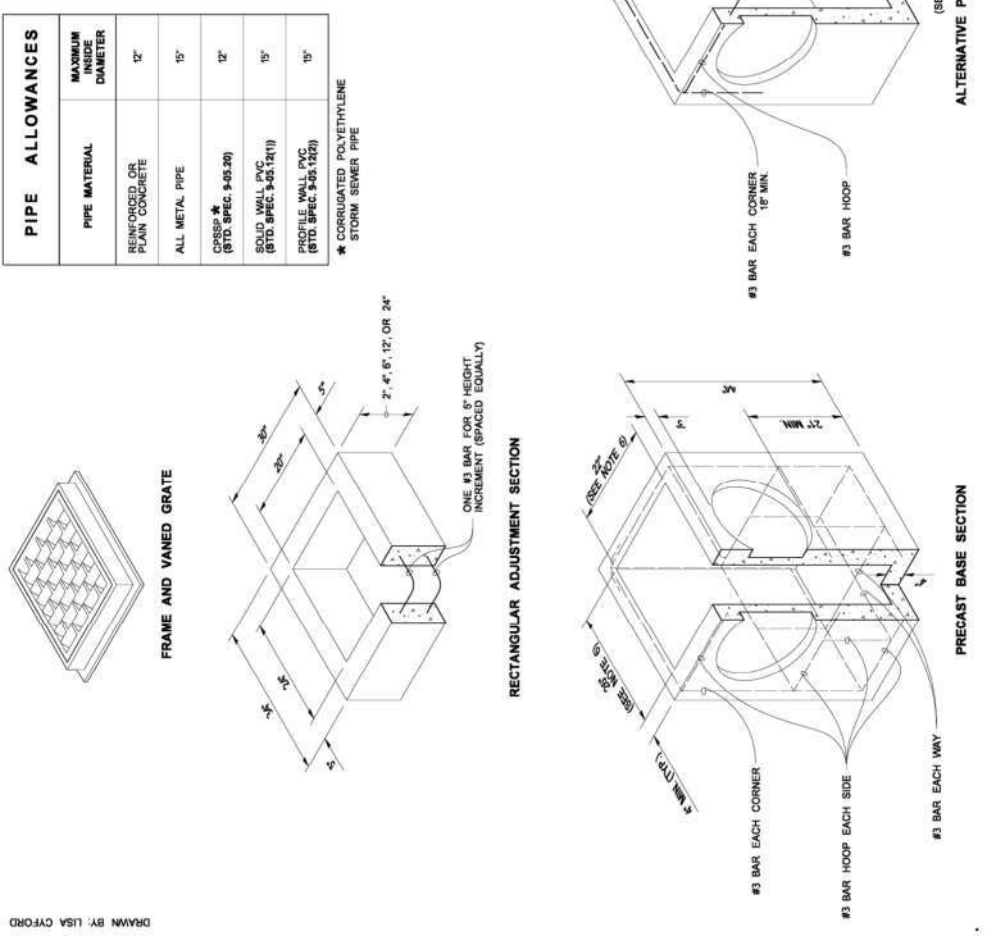

4 WSDOT STANDARD DETAIL
SCALE: NTS

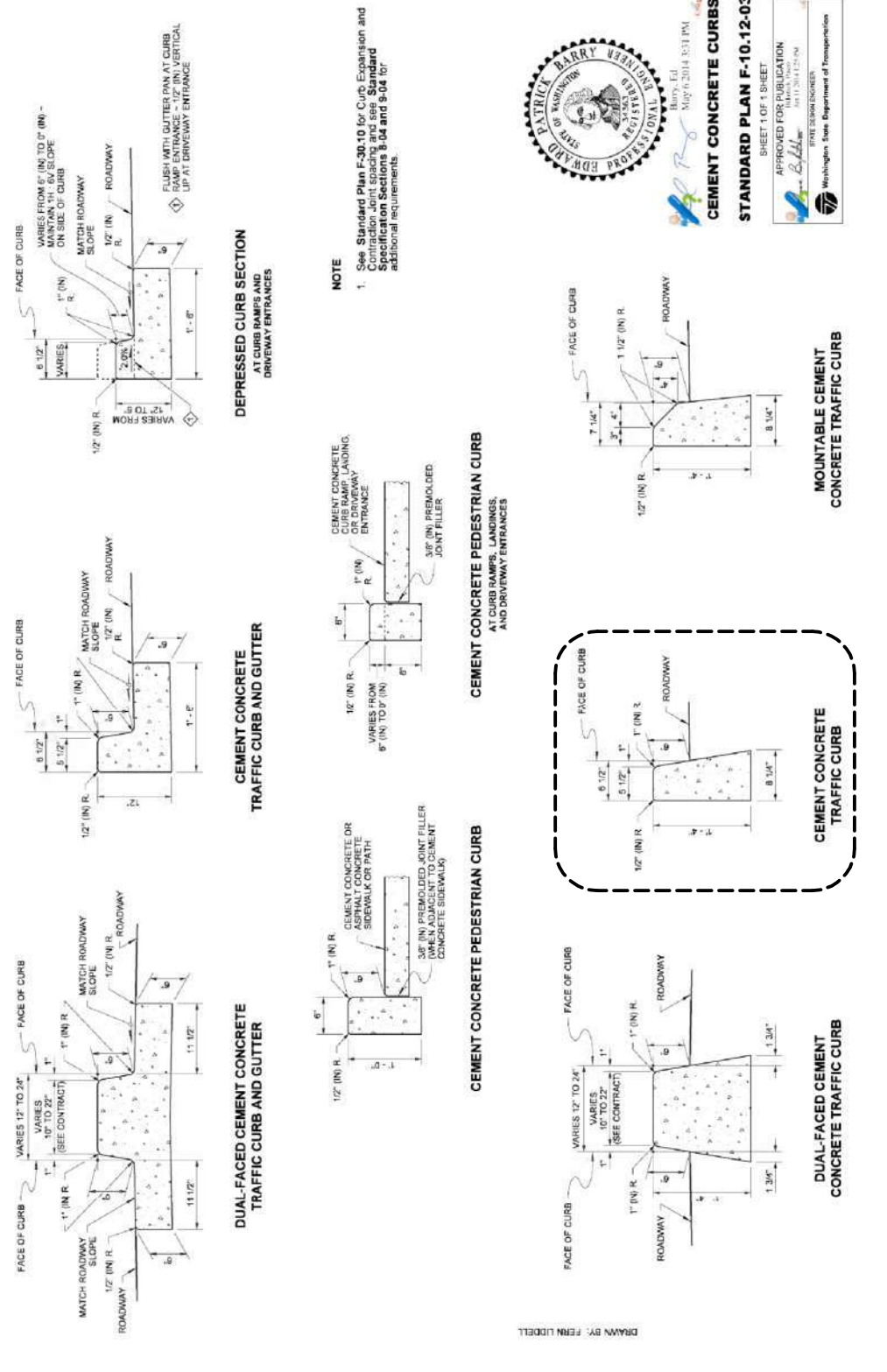

6 WSDOT STANDARD DETAIL
SCALE: NTS

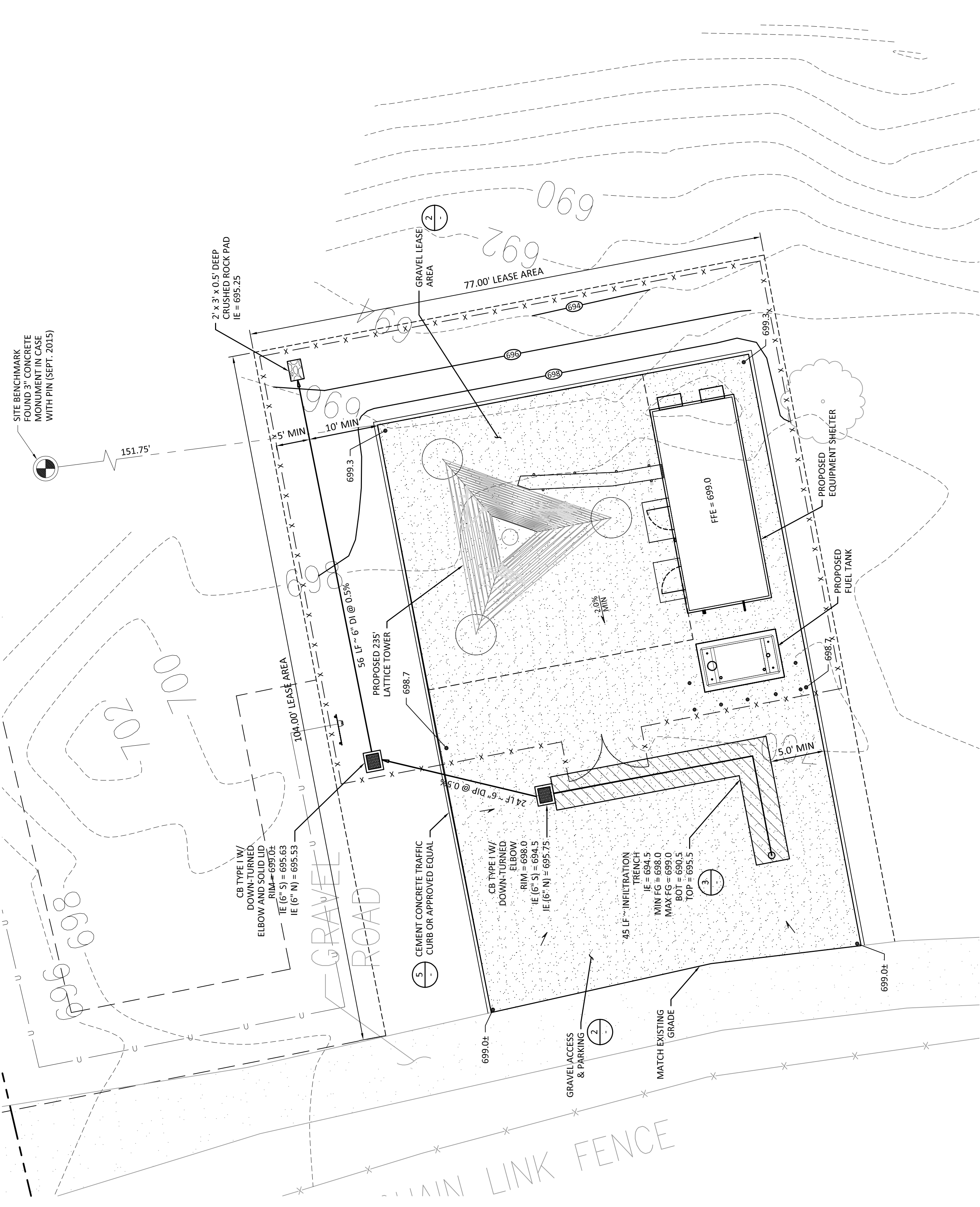

1 GRADING AND DRAINAGE PLAN
SCALE: 1" = 10'

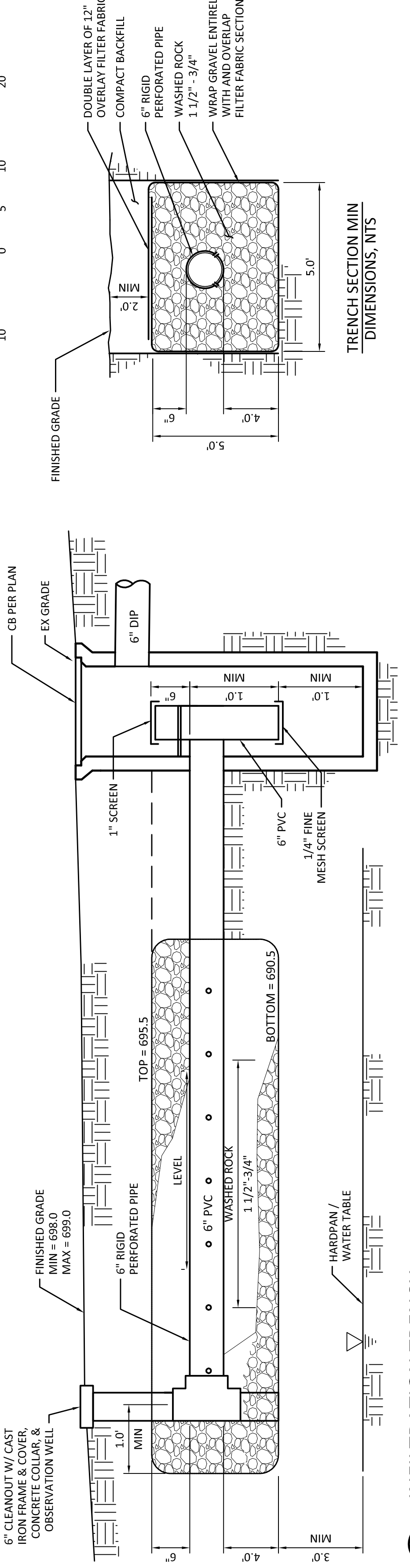

3 INFILTRATION TRENCH
SCALE: NTS



SWAN
(NEW BUILD)
39025 NE NORTH FORK RD.
DUVALL, WA 98019

DEBELA PACIFIC CORPORATION
5506 6TH AVE. S. SUITE 202
SEATTLE, WA 98108
PHONE: (206) 460-3826
WWW.DBELA.COM

CAMP+ ASSOCIATES
19401 40TH AVE. W. SUITE 304
BLISS, WA 98005
PHONE: (425) 740-8392
FAX: (425) 252-2880
WWW.CAMPASSOC.COM

PROJECT MANAGER: EJC

PREPARED BY: AIO/EAT

APPROVED BY: PN

- 07/31/17 UPDATED SURVEY
- 07/31/17 DPER COMMENTS
- 06/27/17 ELECTRICAL TIE-IN W/ SCL
- 06/15/17 ISSUED FOR PERMIT

PLAN REVIEWERS SIGNATURE

ARCHITECTS STAMP
7727
REGISTERED ARCHITECT
CAROL NIXON
STATE OF WASHINGTON
(6010487)

SHEET NAME
OVERALL
PROPOSED
SITE PLAN

SHEET NUMBER
A-1.0

PARCEL SIZE: 457.3 ACRES (100.00%)
NEW IMPERVIOUS: 4,931 SQ. FT. (0.025%)
REPLACED IMPERVIOUS: 0.00 SQ. FT. (0.00%)
NEW PLUS REPLACED IMPERVIOUS: 4,931 SQ. FT. (0.025%)

BEFORE WORK CAN COMMENCE A MANDATORY PRE-CONSTRUCTION MEETING SHALL BE HELD. THE REQUIRED ATTENDEES SHALL INCLUDE:
- PSE&N CONSTRUCTION MANAGER
- GENERAL CONTRACTOR
- SEATTLE PUBLIC UTILITIES REPRESENTATIVE
- SEATTLE CITY LIGHT REPRESENTATIVE

PARCEL:
292608-9002
ZONING: F

SUBJECT PARCEL:
292608-9004
ZONING: F



2 TREE REMOVAL PLAN

SCALE: 1/16" = 1'-0" (22x34), 1/32" = 1'-0" (11x17)

TOTAL TREES TO BE REMOVED: 24

TREES TO BE REMOVED					
NUMBER	TRUNK DIAMETER	TYPE	HEIGHT	QTY.	HEIGHT QTY.
1	10"	ALDER	30'	1	35'
2	8"	ALDER	40'	1	40'
3	8"	ALDER	45'	1	40'
4	6"	ALDER	30'	1	35'
5	12"	FIR	45'	1	35'
6	10"	ALDER	35'	1	45'
7	10"	ALDER	30'	1	45'
8	10"	ALDER	35'	1	30'
9	10"	ALDER	35'	1	40'
10	12"	ALDER	45'	1	40'
11	12"	ALDER	40'	1	30'
12	12"	MAPLE	45'	1	15'

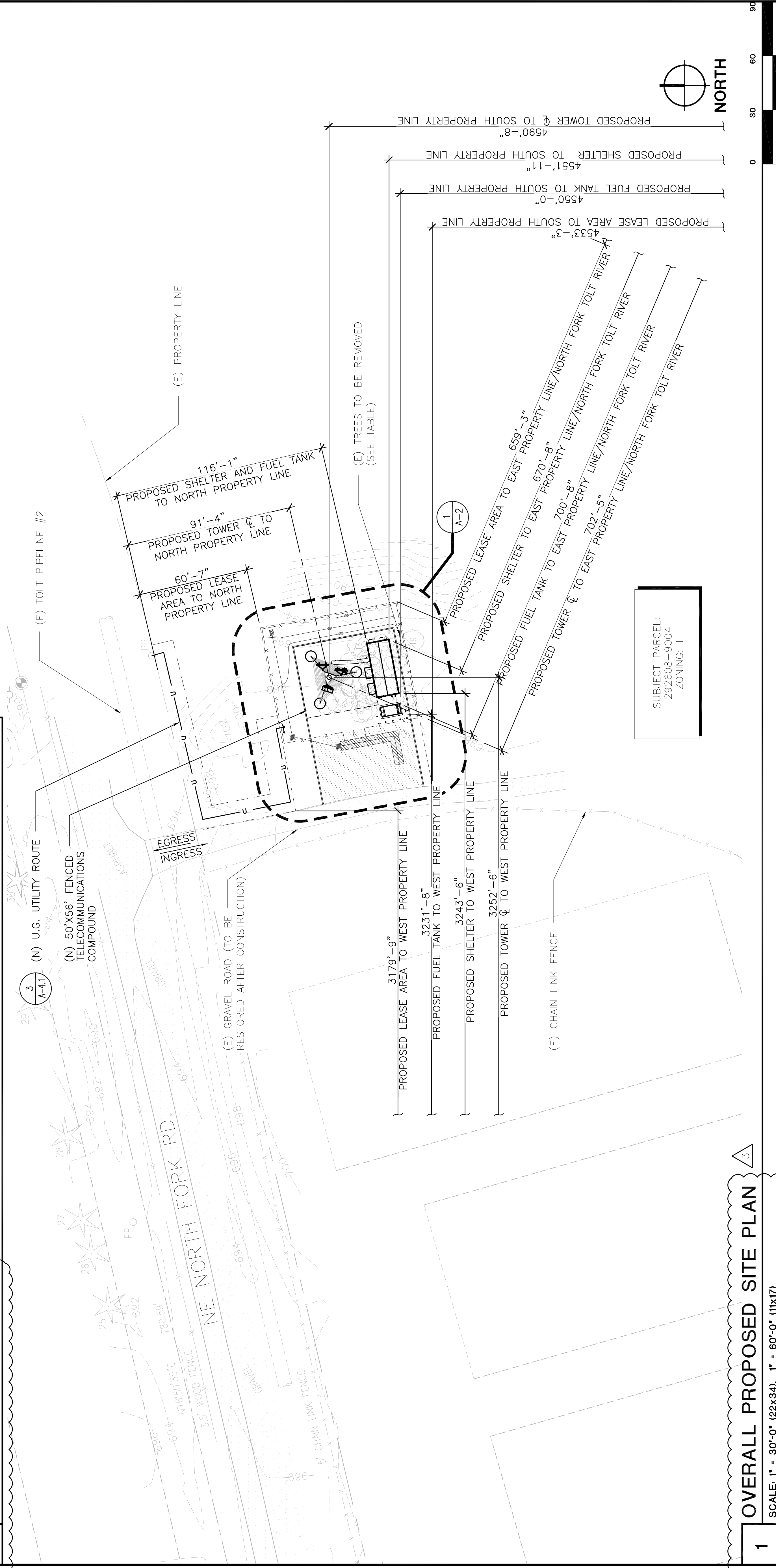

1 OVERALL PROPOSED SITE PLAN

SCALE: 1" = 30'-0" (22x34), 1" = 60'-0" (11x17)

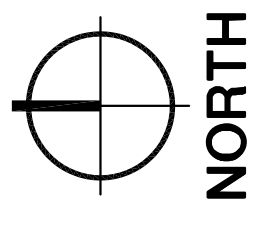

0 30 60 90

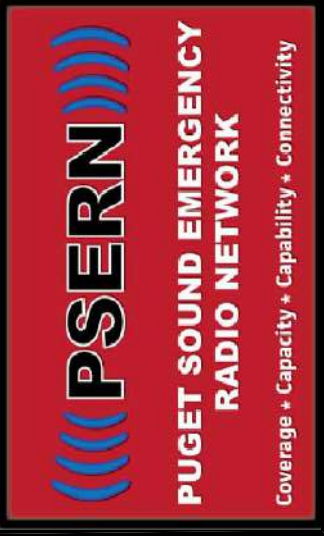

SWAN
(NEW BUILD)
39025 NE NORTH FORK RD.
DUVALL, WA 98019

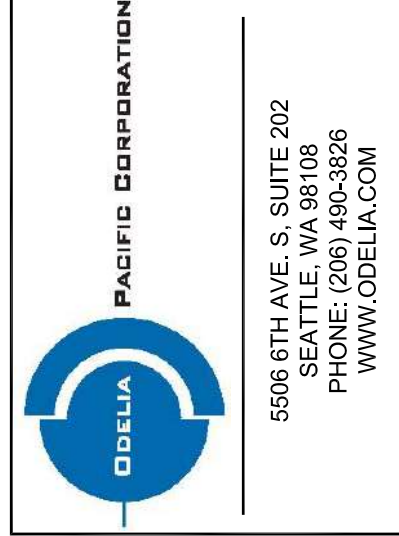

PROJECT MANAGER: EJC

PREPARED BY: AIO/EAT

APPROVED BY: PN

▲	07/31/17	UPDATED SURVEY
▲	07/21/17	PIPER COMMENTS
▲	06/27/17	ELECTRICAL TIE-IN W/ SCL
▲	06/15/17	ISSUED FOR PERMIT

PLAN REVIEWERS SIGNATURE

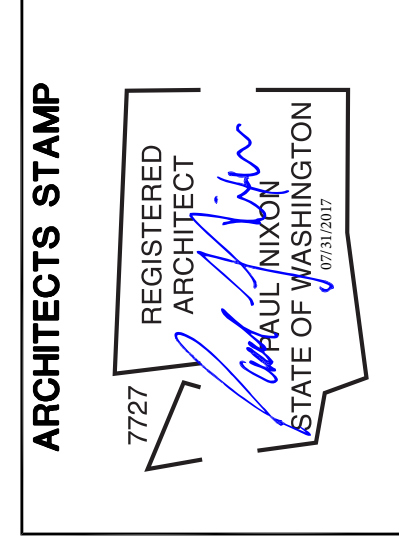

SHEET NAME
ANTENNA PLAN

SHEET NUMBER
A-2

ANTENNA / COAX SCHEDULE

RAD CENTER	PATH	MOUNTING HEIGHT	AZIMUTH	TOWER LEG	QTY.	DESCRIPTION	COAX	COAX LENGTH
230'-0"	RING HILL	-	288°	NW	1	6' HIGH PERFORMANCE MICROWAVE ANTENNA	EW63	±265'
100'-0"	TOLT	-	110°	SE	1	3' HIGH PERFORMANCE MICROWAVE ANTENNA	EW90	±135'
-	-	170'-0"	90°	NE	2	18'-0" ENCLOSED DIPOLE RX ANTENNAS	AVAS-50FX	±205'
-	-	150'-0"	90°	SE	2	4'-5" ENCLOSED DIPOLE TX ANTENNA	AVAS-50FX	±185'

NOTE:
PROVIDE (1) DUAL DIVERSITY TOWER TOP AMPLIFIER SYSTEM.
SYSTEM SHALL INCLUDE: (1) DUAL DIVERSITY TOWER TOP AMPLIFIER (TTA).
(4) 7/8" COAXIAL CABLES (2 LINES ARE JUMPERS FROM THE TTA TO ANTENNAS).
(1) 1/2" COAXIAL CABLE (FSJ4-50B).

- GENERAL NOTES**
- VERIFY EACH COAXIAL CABLE LENGTH, DIAMETER, ROUTING, AND ALL MOUNTING APPURTENANCES WITH OWNER PRIOR TO ORDER.
 - THE MAXIMUM COAXIAL CABLE LENGTH HAS BEEN ESTIMATED IN THE TABLE ABOVE. THIS CABLE LENGTH IS APPROXIMATE AND IS TO BE USED FOR CONSTRUCTION. ACTUAL ANTENNA CABLE LENGTHS MAY VARY FROM ESTIMATED MAXIMUM LENGTH AND MUST BE VERIFIED.
 - TAG ALL MAIN CABLES AT THREE (3) LOCATIONS:
A - ANTENNAS
B - ANTENNA ENTRY PORT
C - EQUIPMENT CABINET
 - EACH COAX SHALL BE GROUNDED AT (3) THREE LOCATIONS; ANTENNA, TOWER BASE AND BUILDING ENTRY PORT.

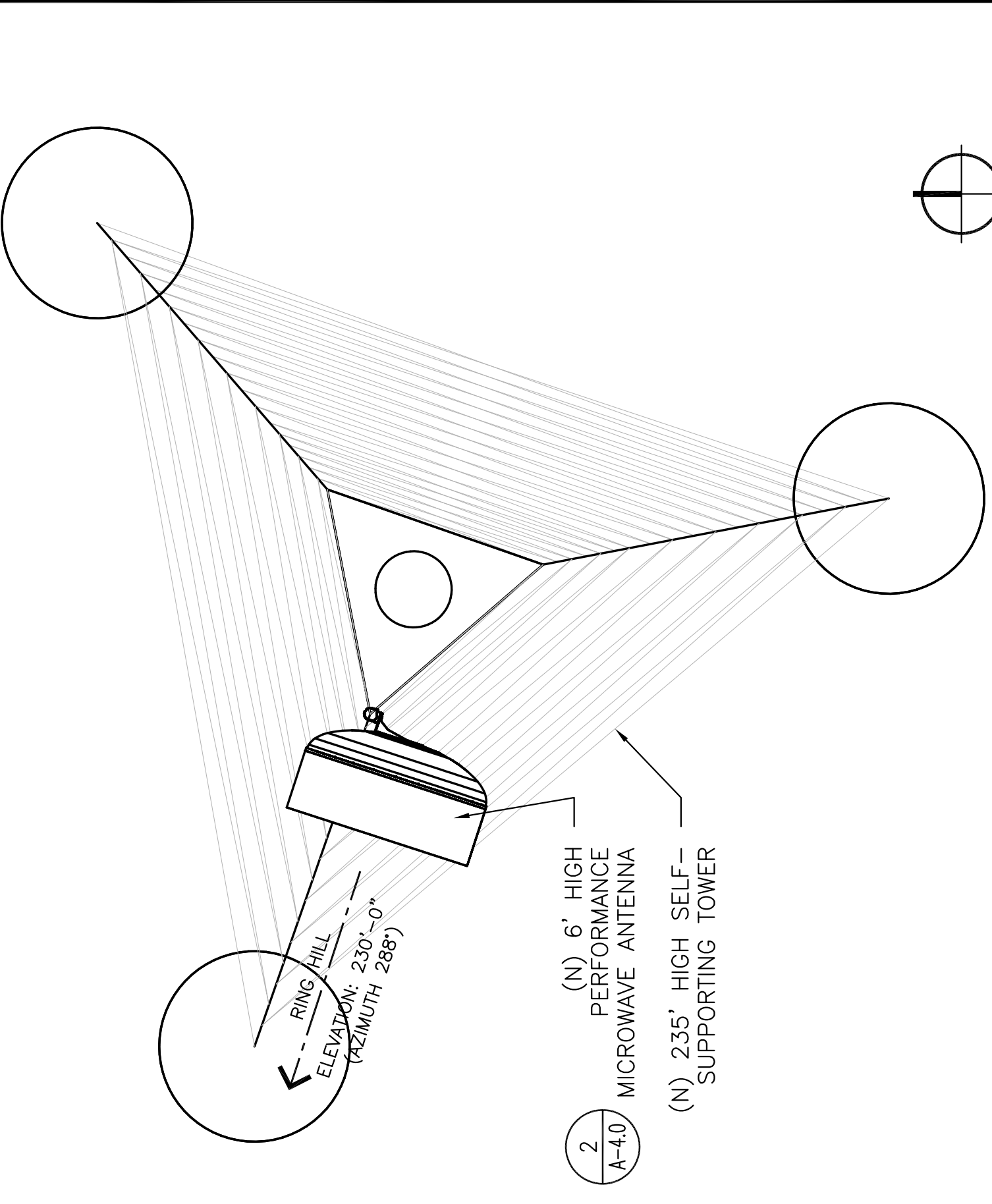

1 ANTENNA PLAN @ 230'-0"
SCALE: 1/4" = 1'-0" (22x34), 1/8" = 1'-0" (11x17)

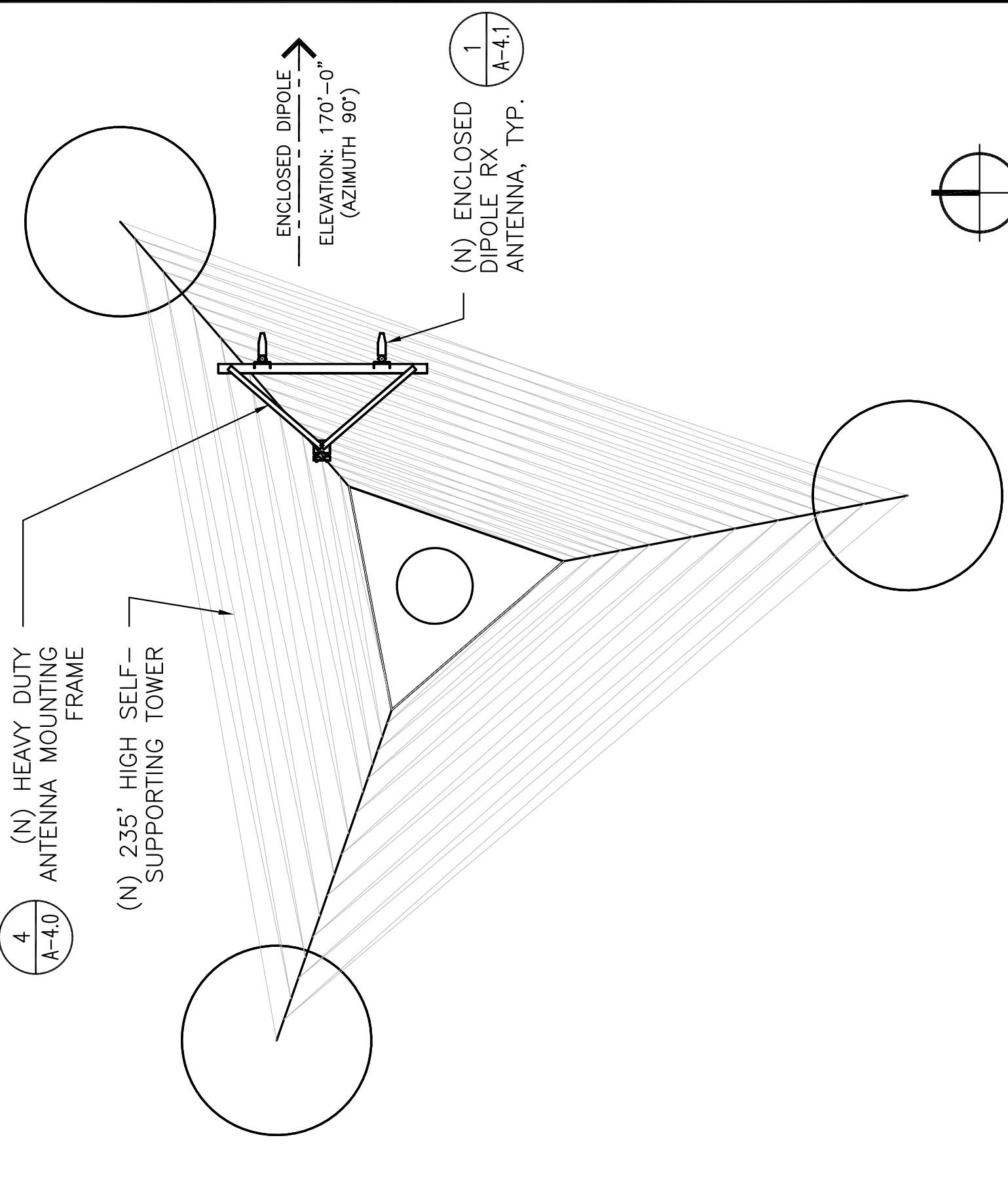

2 ANTENNA PLAN @ 170'-0"
SCALE: 1/4" = 1'-0" (22x34), 1/8" = 1'-0" (11x17)

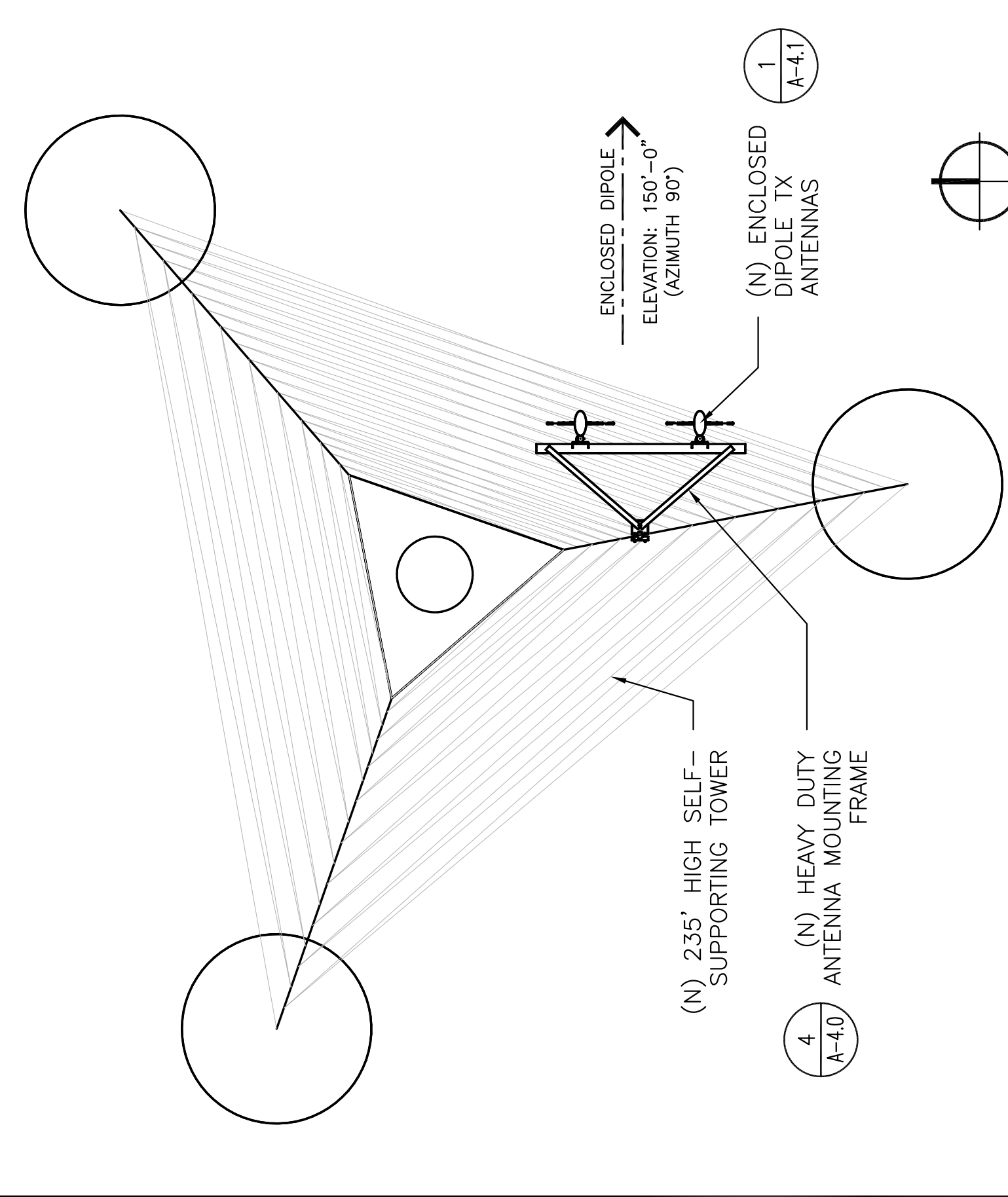

3 ANTENNA PLAN @ 150'-0"
SCALE: 1/4" = 1'-0" (22x34), 1/8" = 1'-0" (11x17)

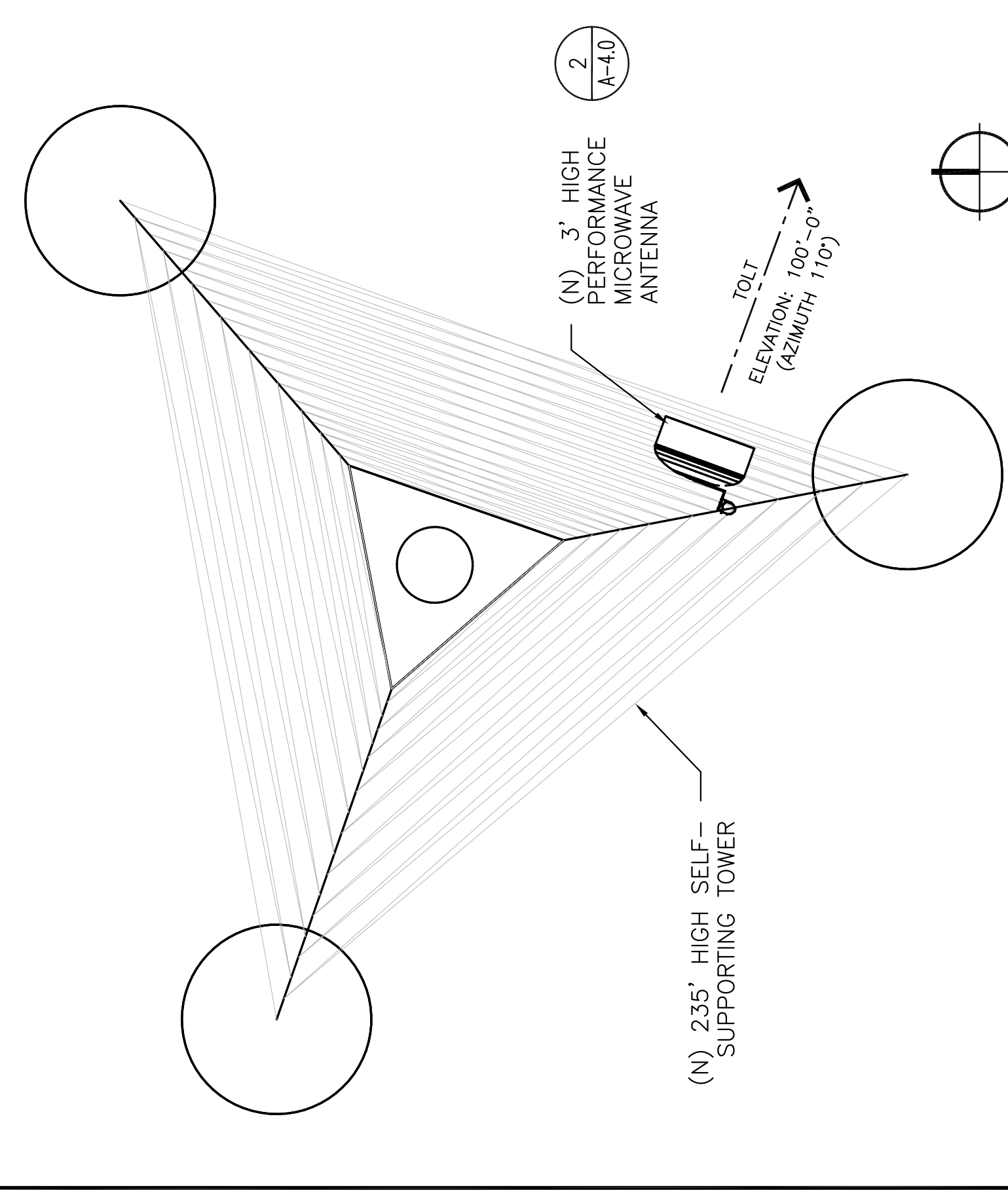

4 ANTENNA PLAN @ 100'-0"
SCALE: 1/4" = 1'-0" (22x34), 1/8" = 1'-0" (11x17)

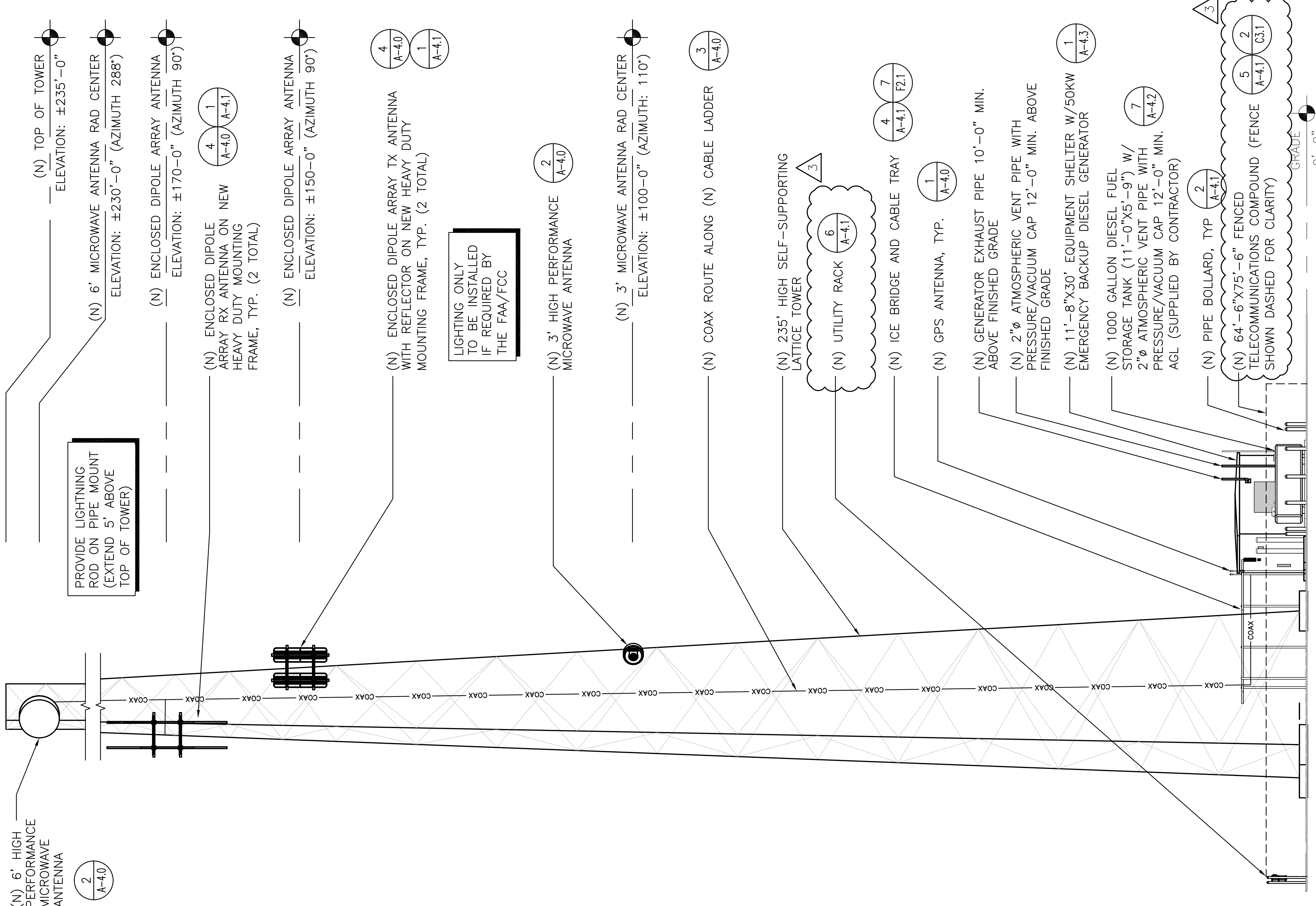
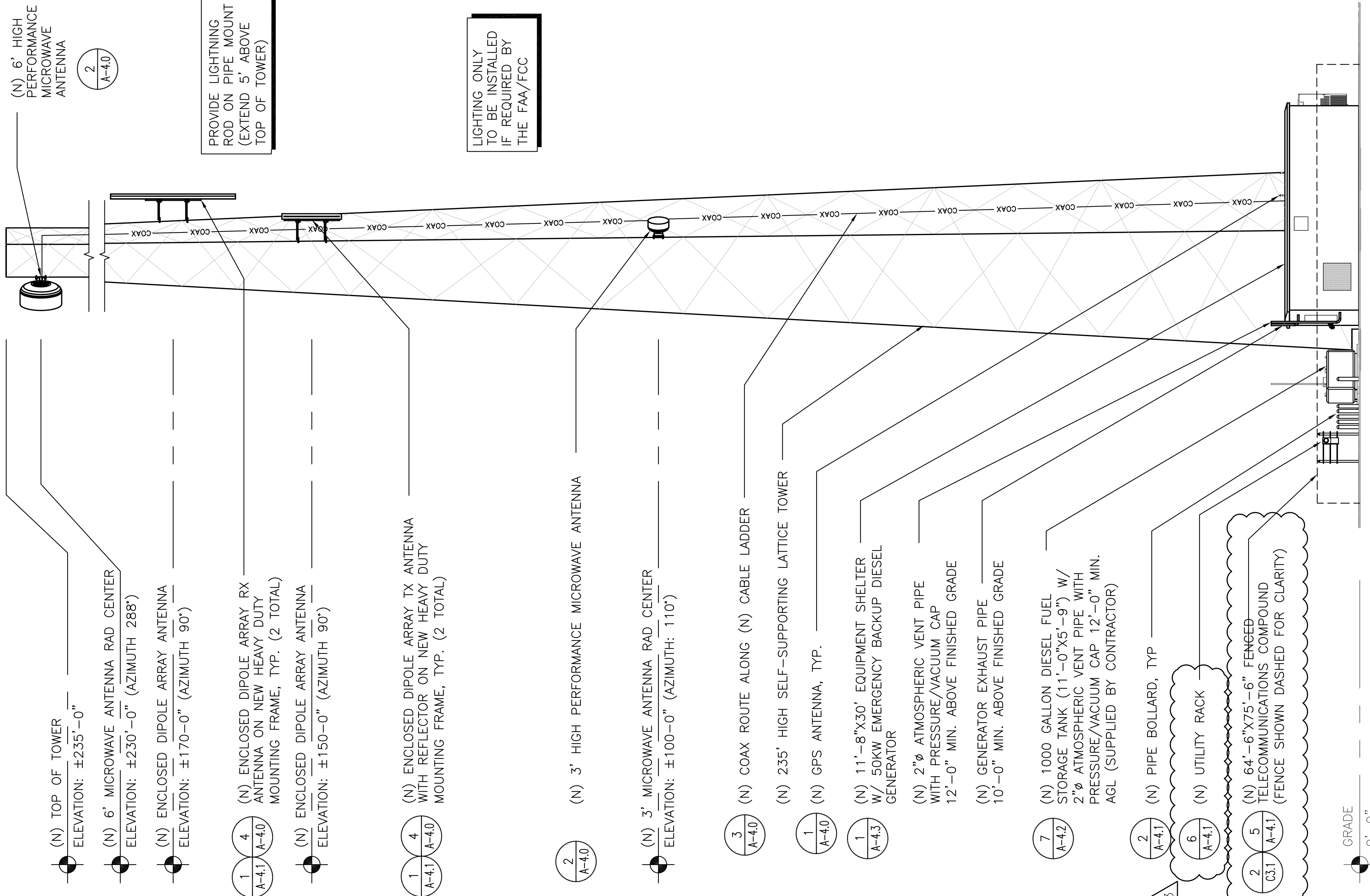

King County
PSERN
PUGET SOUND EMERGENCY RADIO NETWORK
Coverage • Capacity • Capability • Connectivity

SWAN
 (NEW BUILD)
 39025 NE NORTH FORK RD.
 DUVALL, WA 98019

DELLA PACIFIC CORPORATION
 5606 6TH AVE S, SUITE 202
 SEATTLE, WA 98108
 PHONE: (206) 490-3826
 WWW.DELLA.COM

CAMP+ ASSOCIATES
 19401 40TH AVE. W, SUITE 304
 LYNNWOOD, WA 98036
 PHONE: (425) 740-6392
 FAX: (425) 252-2860
 WWW.CAMPASSOC.COM

PROJECT MANAGER: EJC

PREPARED BY: AJO/EAT

APPROVED BY: PN

▲	07/31/17	UPDATED SURVEY
▲	07/21/17	PIPER COMMENTS
▲	06/27/17	ELECTRICAL TIE-IN W/ SCL
▲	06/15/17	ISSUED FOR PERMIT

PLAN REVIEWERS SIGNATURE

ARCHITECTS STAMP

SHEET NAME
 PROPOSED ELEVATIONS

SHEET NUMBER
 A-3

1 **PROPOSED SOUTH ELEVATION**
 SCALE: 1" = 10'-0" (22x34), 1" = 20'-0" (11x17)

2 **PROPOSED WEST ELEVATION**
 SCALE: 1" = 10'-0" (22x34), 1" = 20'-0" (11x17)

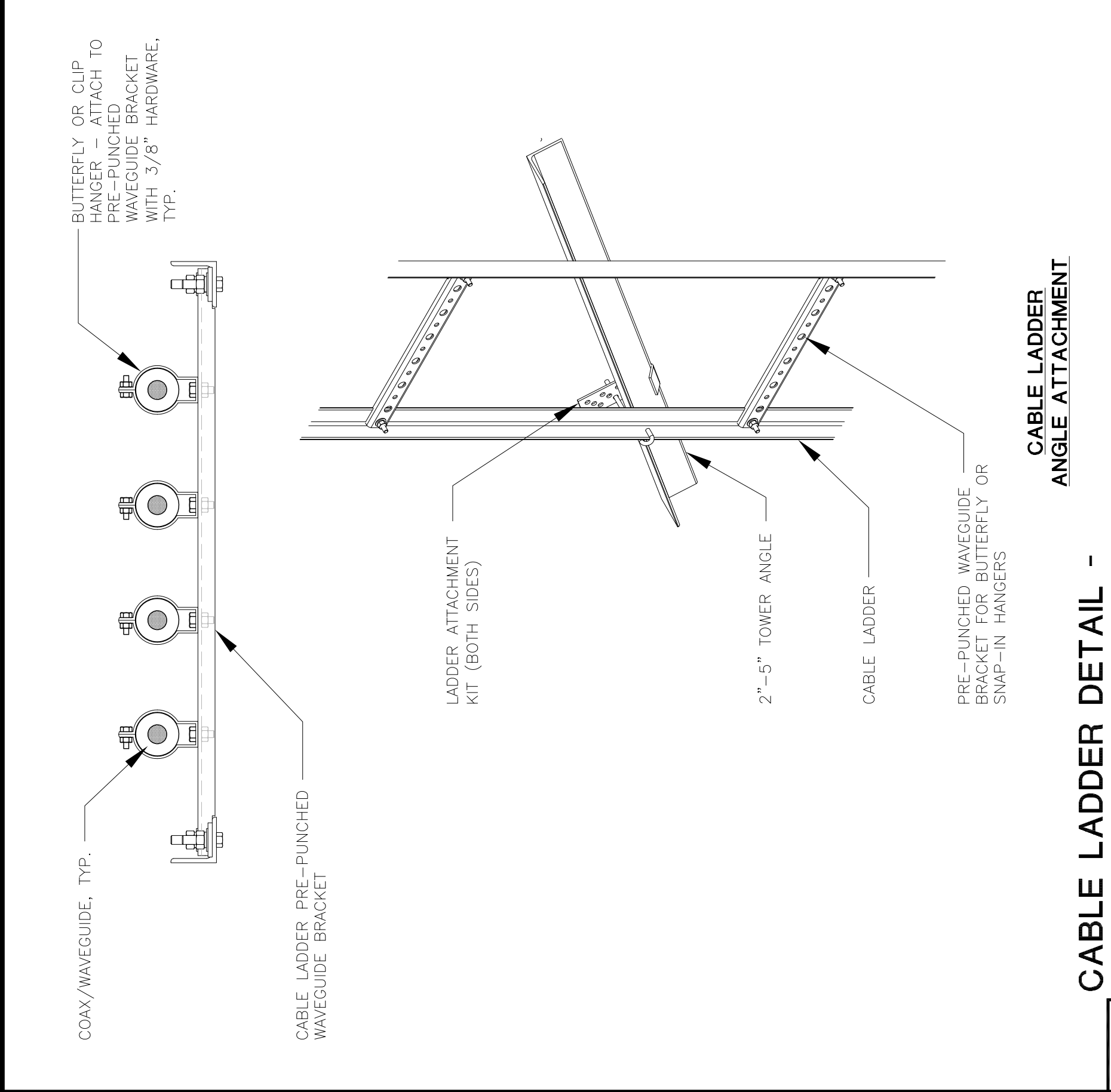

3
CABLE LADDER DETAIL - LATTICE TOWER
 NOT TO SCALE

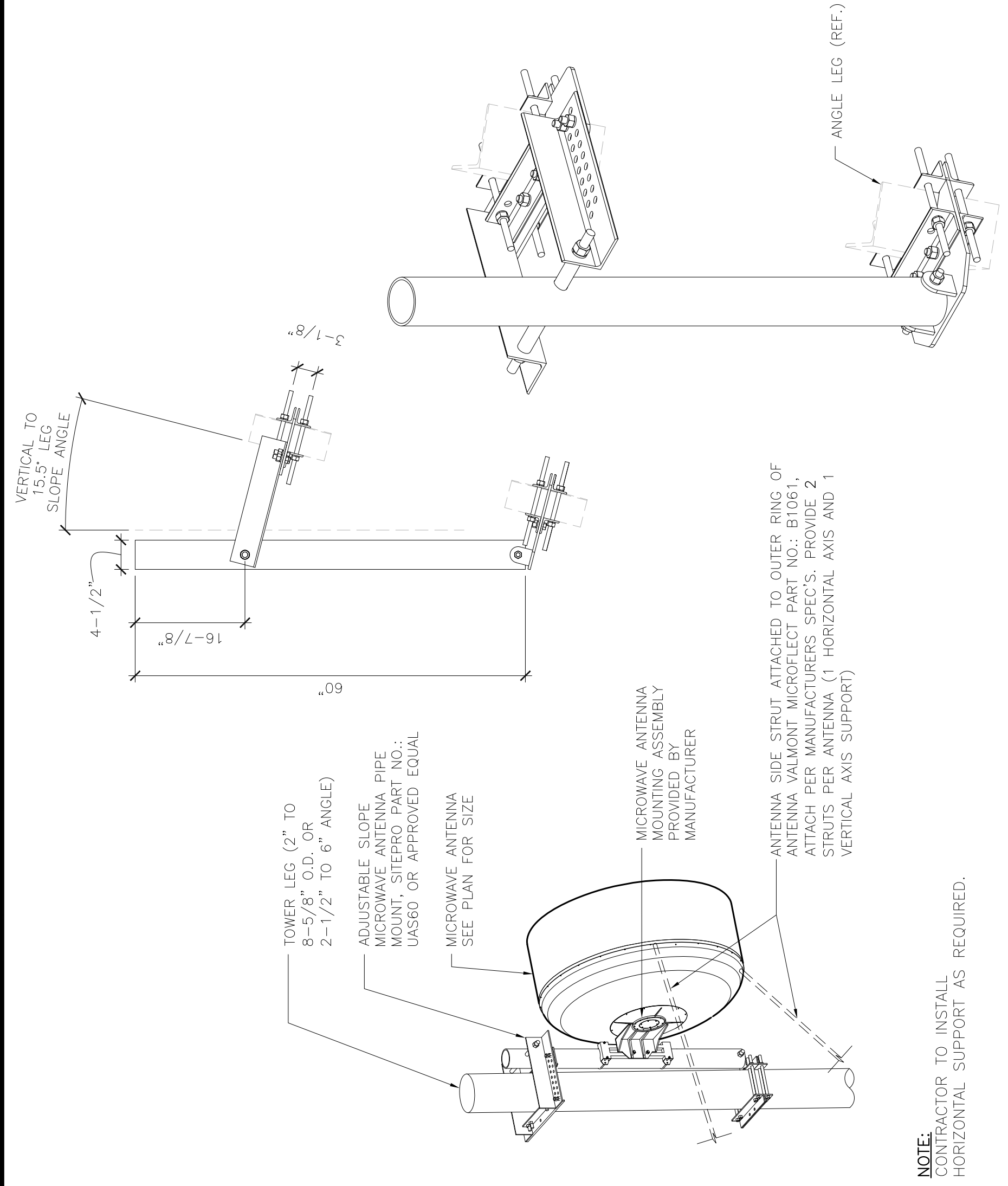

2
MW ANTENNA MOUNT ASSEMBLY
 NOT TO SCALE

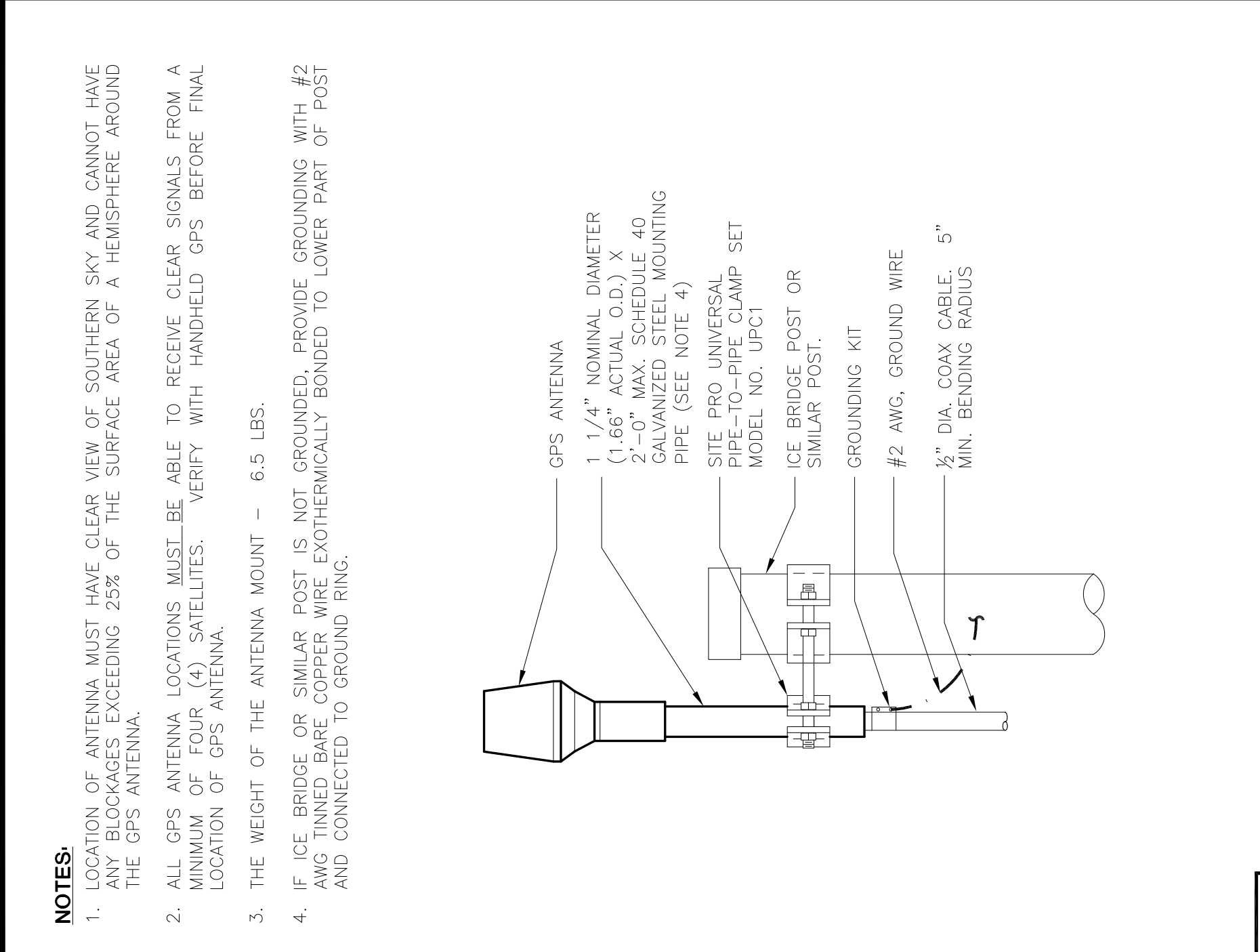

1
GPS ANTENNA MOUNTING DETAIL
 NOT TO SCALE

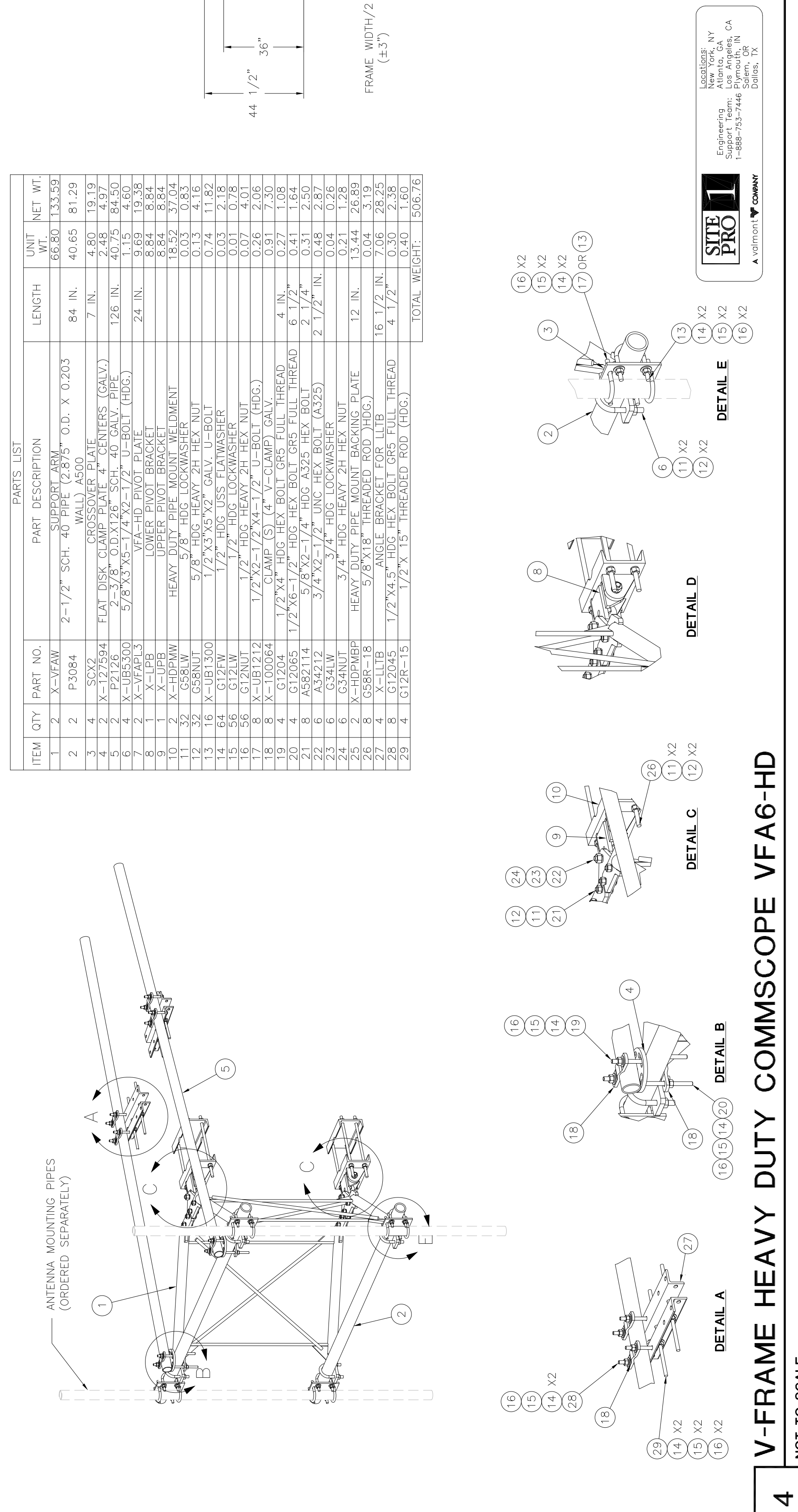
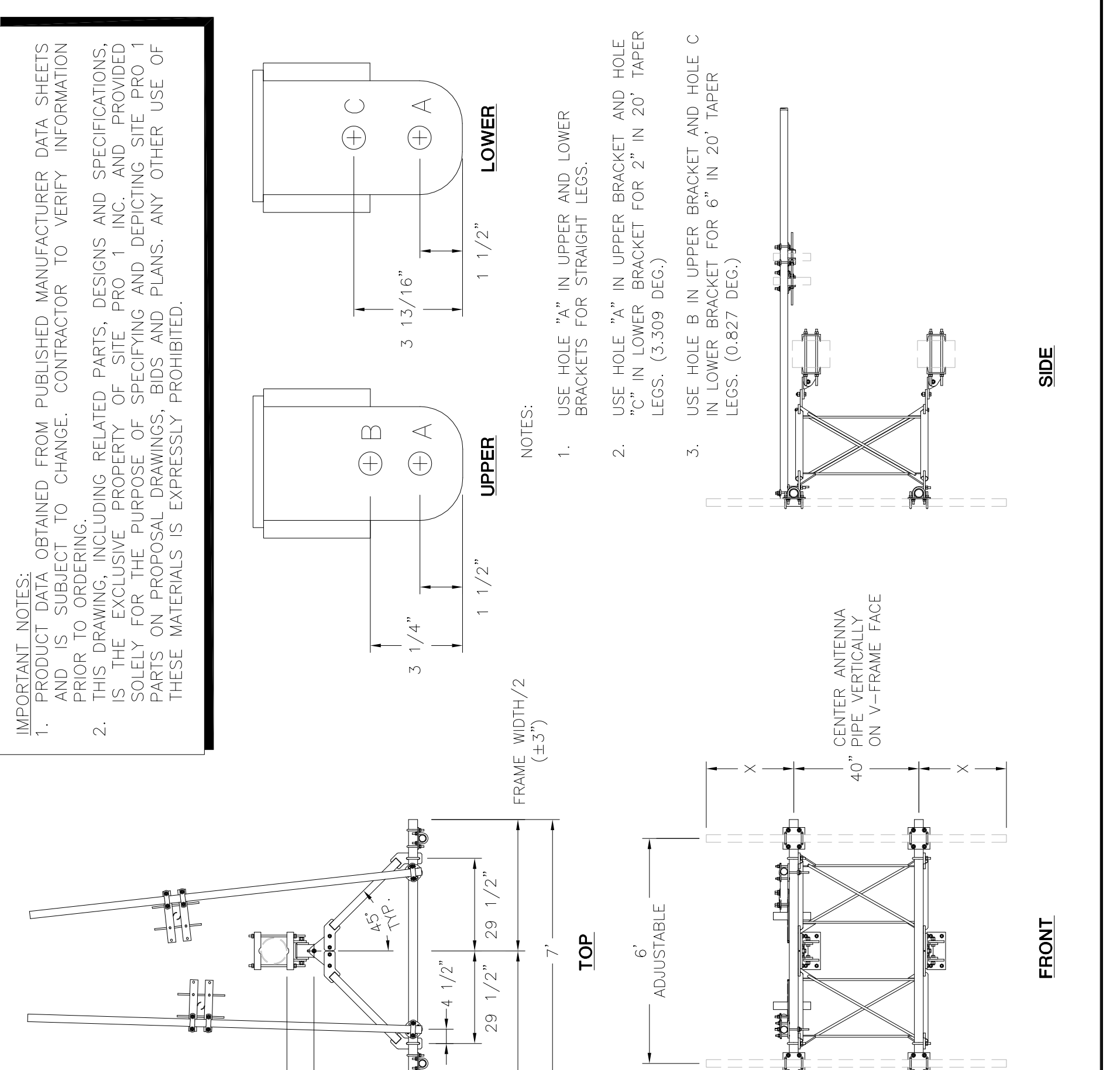

4
V-FRAME HEAVY DUTY COMMSCOPE VFA6-HD
 NOT TO SCALE

SITE PRO 1
 A valmont COMPANY
 Locations: New York, NY; Los Angeles, CA; Plymouth, IN; Dallas, TX
 Engineering Support Team: 1-888-753-7448

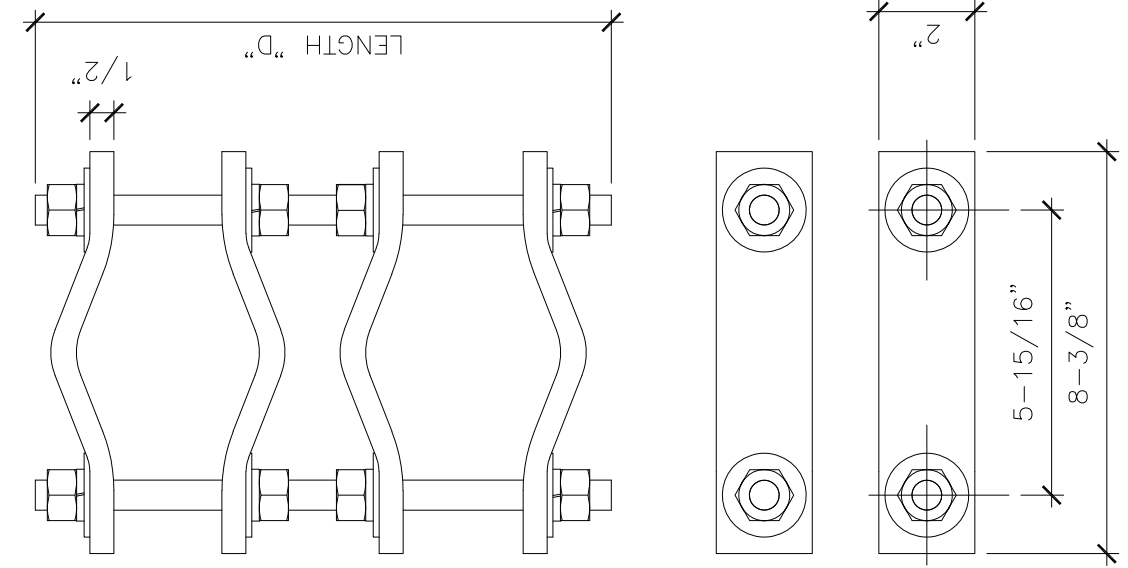

1 SITE PRO DCP12K PIPE TO PIPE CLAMP SET

NOT TO SCALE

NOTES:

1. ALL CORNER POSTS SHALL HAVE BARB WIRES/ARMS LEANING OUT.
2. ALL CENTRAL DROP BAR ASSEMBLIES SHALL HAVE AN ALUMINUM TYPE MUSHROOM HEAD, PART NO. 15912 MANUFACTURED BY MASTER HALCO, INC. OR APPROVED EQUAL. THE MUSHROOM HEAD SHALL BE EMBEDDED INTO FOUNDATION CONCRETE AS SHOWN.
3. ALL STEEL MATERIAL SHALL BE HOT-DIPPED GALVANIZED AND CONFORM TO FEDERAL SPECIFICATION RL-F 91; FENCING WIRE AND POST METAL (GATES, CHAIN LINK, FENCE FABRIC AND ACCESSORIES).
4. GATE HINGE BOLTS SHALL HAVE THEIR THREADS PEENED OR WELDED TO PREVENT UNAUTHORIZED REMOVAL.

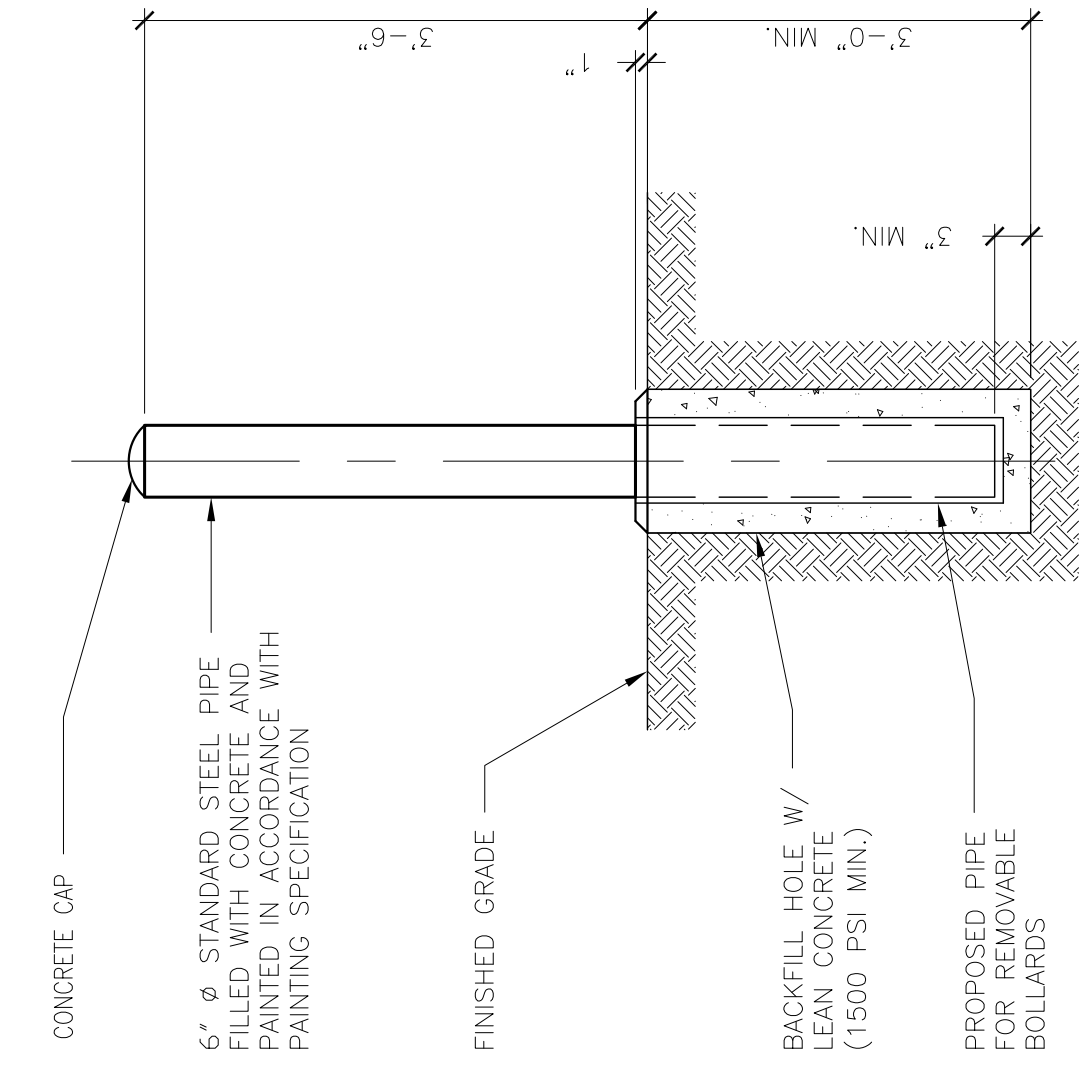

2 BOLLARD DETAIL

NOT TO SCALE

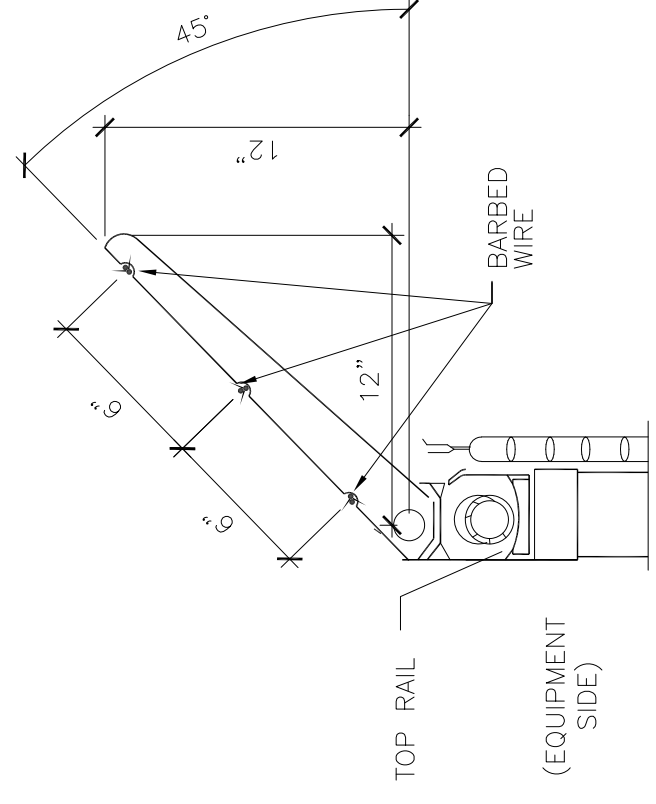

A BARBED WIRE ARM DETAIL

SCALE: 1 1/2" = 1'-0"

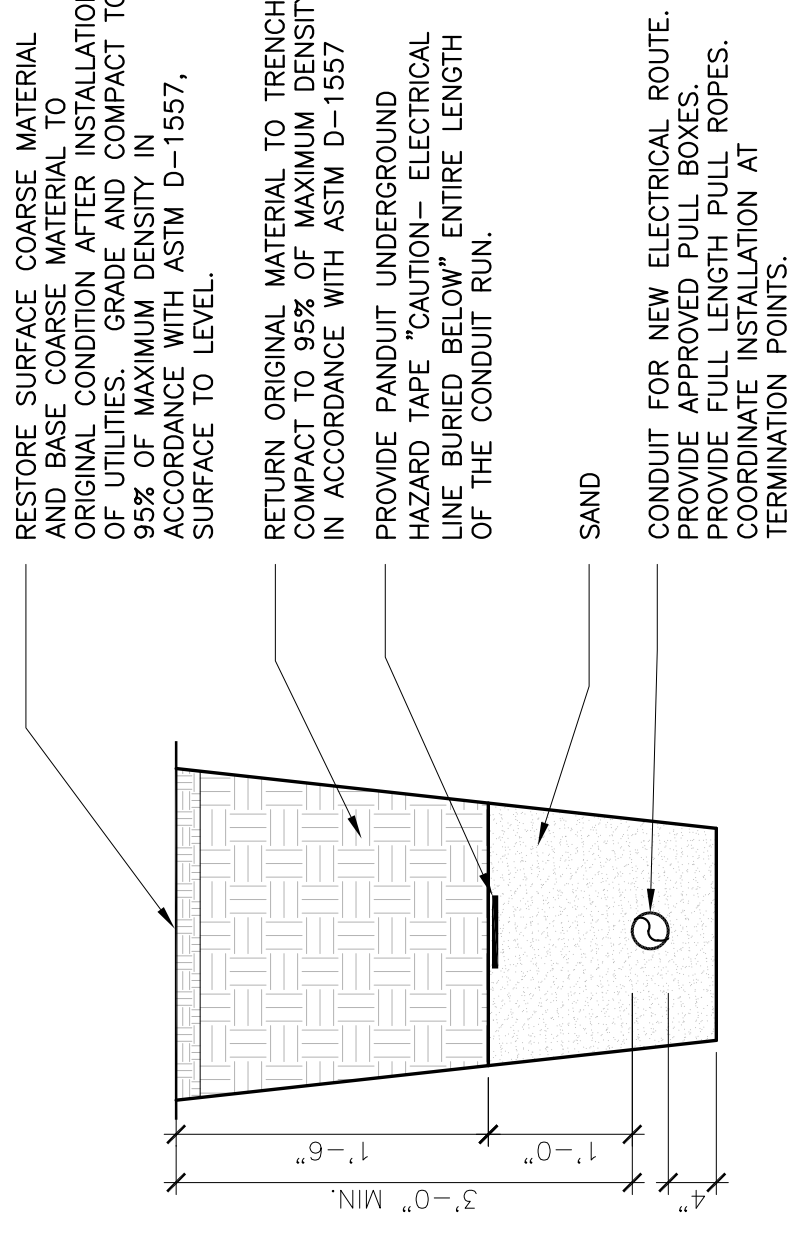

NOTE:
BACKFILL MATERIAL SHOULD BE SUITABLE MATERIAL FREE OF ORGANIC MATERIAL WITHOUT ANY ROCK GREATER THAN 4" IN SIZE IN THE GREATEST DIMENSION.

3 UTILITY TRENCH DETAIL

NOT TO SCALE

- NOTES:**
- CONNECT EACH SUPPORT LEG TO GROUND RUNS PER GROUNDING DETAILS AND SPECS.
 - ALL STEEL PLATES, BOLTS, PIPES OR OTHER COMPONENTS TO BE HOT ROLLED GALVANIZED AND CONFORM W/ THE STANDARD FENCE SPECS.
 - CABLE SUPPORT SPACING EVERY 3'-0" O.C.
 - WAVEGUIDE BRIDGE TO BE SUPPLIED BY CONTRACTOR.

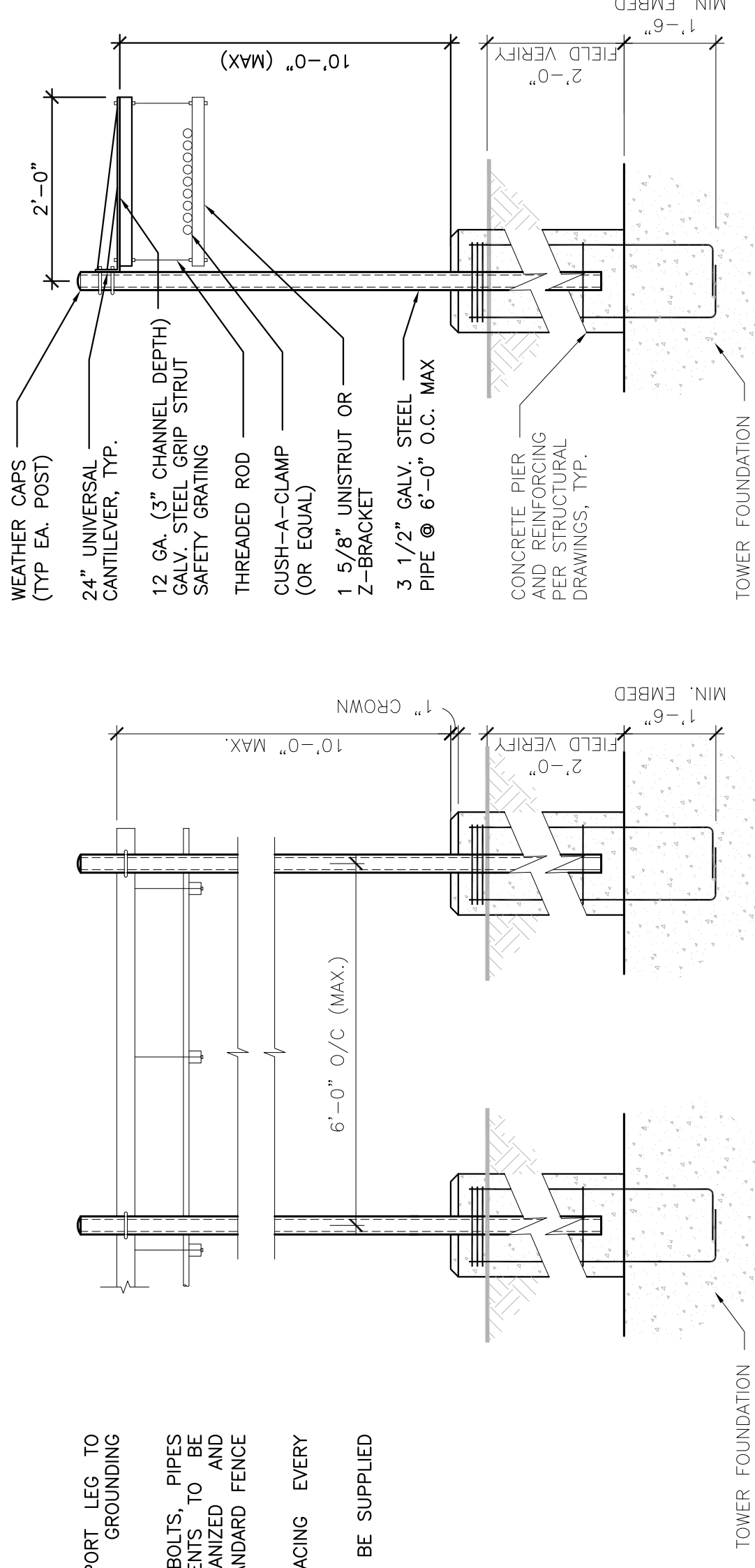

4 ICE BRIDGE DETAIL

NOT TO SCALE

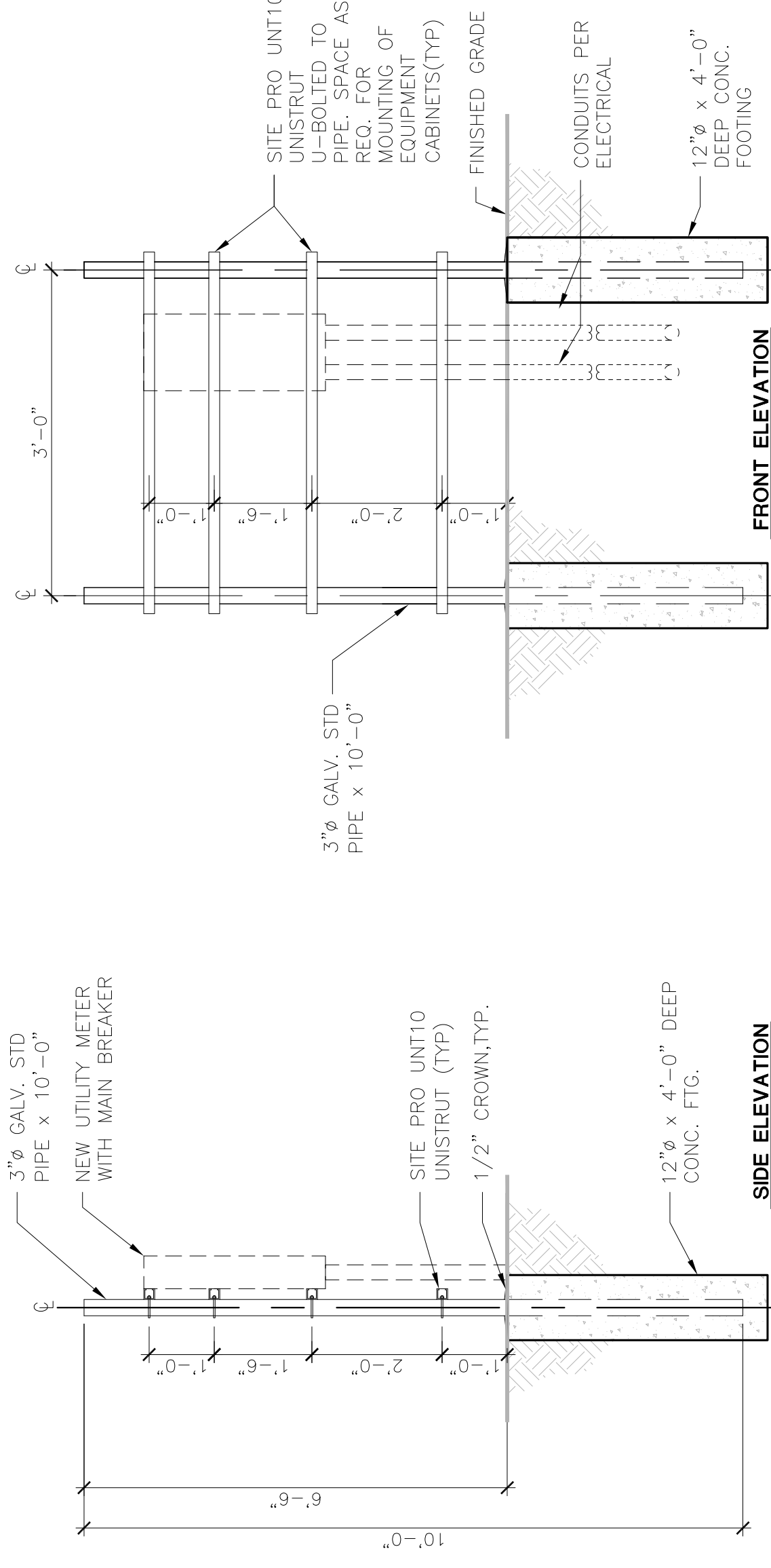

6 UTILITY RACK DETAIL

NOT TO SCALE



SWAN

(NEW BUILD)

39025 NE NORTH FORK RD.
DUVALL, WA 98019



5506 6TH AVE. S. SUITE 202
SEATTLE, WA 98108
PHONE: (206) 461-3636
WWW.ODEBIA.COM



19401 40TH AVE W. SUITE 304
LYNNWOOD, WA 98036
PHONE: (425) 749-6392
FAX: (425) 252-2880
WWW.CAMPASSOC.COM

PROJECT MANAGER: EJC

PREPARED BY: AO/EAT

APPROVED BY: PN

▲	07/31/17	UPDATED SURVEY
▲	07/21/17	DPER COMMENTS
▲	06/27/17	ELECTRICAL TIE-IN W/ SCL
▲	06/15/17	ISSUED FOR PERMIT

PLAN REVIEWERS SIGNATURE

ARCHITECTS STAMP

REGISTERED ARCHITECT
PAUL NIXON
STATE OF WASHINGTON
7727

SHEET NAME

DETAILS

SHEET NUMBER

A-4.1

5 FENCE AND FENCE POST DETAIL

NOT TO SCALE

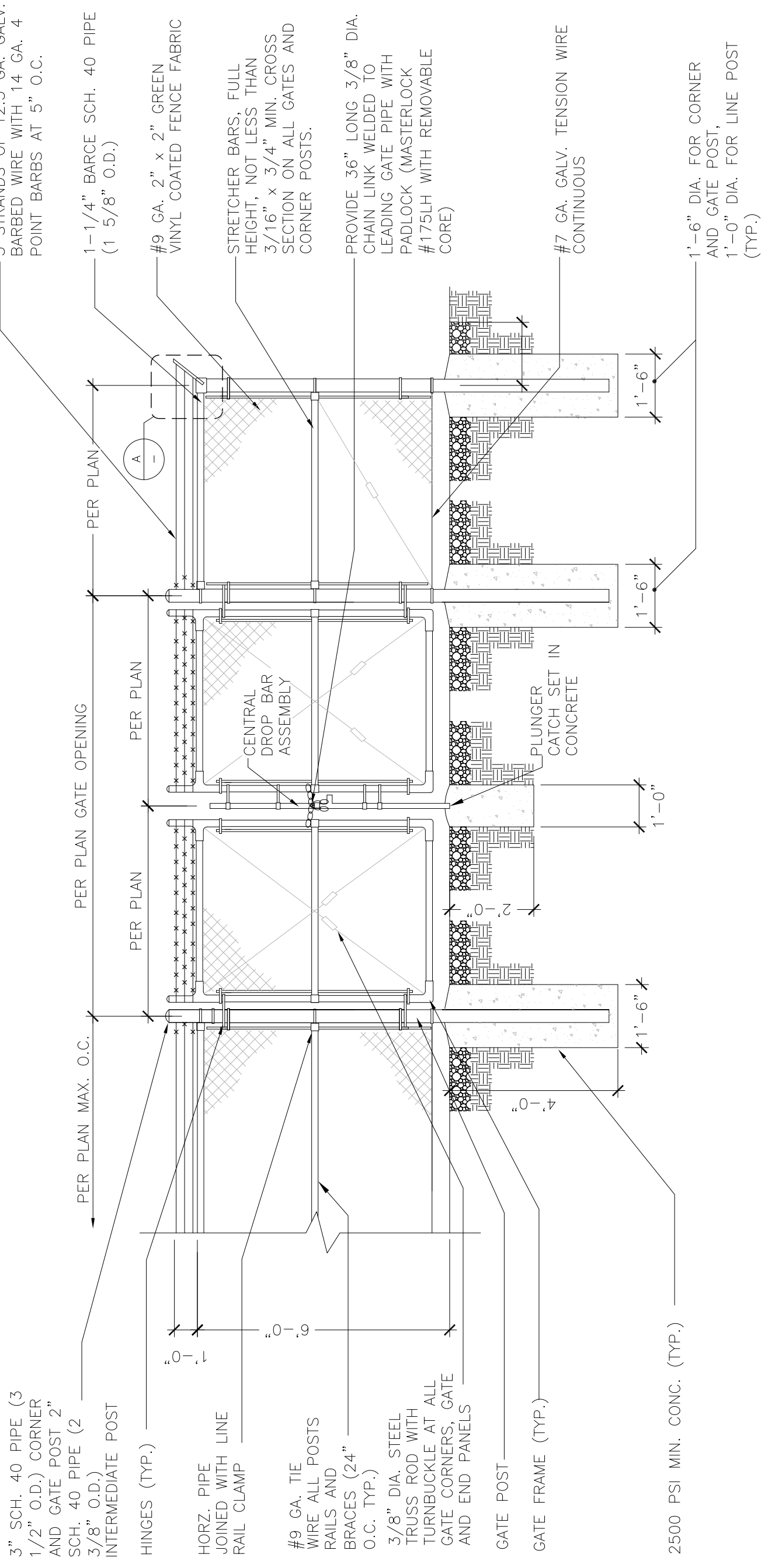

King County

PSERN
PUGET SOUND EMERGENCY
RADIO NETWORK
Coverage • Capacity • Capability • Connectivity

SWAN
(NEW BUILD)
39025 NE NORTH FORK RD.
DUVALL, WA 98019

5606 6TH AVE. S. SUITE 202
SEATTLE, WA 98108
PHONE: (206) 490-3826
WWW.ODELIA.COM

19401 40TH AVE. W. SUITE 304
LYNNWOOD, WA 98036
PHONE: (425) 740-6392
FAX: (425) 252-2860
WWW.CAMPASSOC.COM

PROJECT MANAGER: EJC

PREPARED BY: AJO/EAT

APPROVED BY: P/N

▲	07/31/17	UPDATED SURVEY
▲	07/21/17	PIPER COMMENTS
▲	06/27/17	ELECTRICAL TIE-IN W/ SCL
▲	06/15/17	ISSUED FOR PERMIT

PLAN REVIEWERS SIGNATURE

ARCHITECTS STAMP

SHEET NAME
DETAILS

SHEET NUMBER
A-4.2

1 NOT USED

4 RF WARNING SIGN
NOT TO SCALE

NOTE: INSTALL PER MANUFACTURER SPECIFICATIONS AND FCC GUIDELINES

2 NOT USED

5 RF WARNING SIGN
NOT TO SCALE

NOTE: INSTALL PER MANUFACTURER SPECIFICATIONS AND FCC GUIDELINES

3 NOT USED

6 RF NOTICE SIGN
NOT TO SCALE

8 HAZARDOUS MATERIAL CLASSIFICATION SIGN (DIESEL)
NOT TO SCALE

RED (FIRE HAZARD - FLASH POINT BELOW 200°)
YELLOW (INSTABILITY - STABLE)
WHITE (SPECIFIC HAZARD)
BLUE (HEALTH HAZARD - SLIGHTLY HAZARDOUS)

9 COMBUSTIBLE LIQUIDS SIGN
NOT TO SCALE

7 CONVAULT FUEL TANK DETAIL (1000 GAL.)
NOT TO SCALE

SIDE VIEW
15 GAL. INTEGRAL SPILL CONTAINER, 1 1/2" Ø DRAIN VALVE, 2" Ø NIPPLE STICK PORT, 4" Ø FILL PIPE
11'-0 1/2"
12'-0" MIN. (AGL)
4'-0 1/2"
4"
2" Ø ATMOSPHERIC VENT PIPE WITH PRESSURE/VACUUM CAP (SUPPLIED BY CONTRACTOR)
6" Ø x 9" EMERGENCY VENT PIPE
STEEL TANK

END VIEW
4'-4 1/2"
6"
2" Ø ATMOSPHERIC VENT NIPPLE (SPARE)
4" Ø NIPPLE (SPARE)
30 MIL. POLYETHYLENE GEO MEMBRANE
1/4" POLYSTYRENE
STEEL TANK
STEEL REINFORCEMENT ON CENTER OF WALL

PLAN VIEW
1" Ø COMMUNICATION PORT (CONVAULT USE ONLY)
2" Ø THRU-TANK LEAK DETECTOR WITH ELECTRONIC PROBE FOR MONITORING

CONVAULT 1000-GAL. TANK NOTES:

- STEEL TANK SHALL BE U.L. 142 LISTED FOR ABOVE GROUND STORAGE OF FLAMMABLE LIQUIDS.
- STEEL TANK SKIN SHALL BE 5/16" THICK A.S.T.M. A-36 STEEL PLATE.
- STEL EXPOSED METAL WITH THE EXCEPTION OF STAINLESS STEEL MUST BE POWDER COATED TO INHIBIT CORROSION.
- STEEL TANKS AND SECONDARY CONTAINMENT SHALL BE CONTINUOUSLY WELDED ON THE OUTSIDE.
- STEEL TANK SHALL BE PRESSURE TESTED AT 5 P.S.I.G. FOR 24 HOURS WITHOUT PRESSURE DROP.
- STEEL TANK SHALL BE PRESSURE TESTED AT 5 P.S.I.G. FOR 24 HOURS WITHOUT PRESSURE DROP.
- TANK WALL SYSTEM SHALL BE LISTED IN ACCORDANCE WITH U.L. STANDARD 2085 AND SHOWN TO HAVE A TWO HOUR FIRE RATING.
- Vaults shall have the capability of physical monitoring between the primary and the secondary containment.
- THE SECONDARY CONTAINMENT SHALL CONSIST OF A 30 MIL. HIGH DENSITY POLYETHYLENE GEO MEMBRANE.
- THE VAULT SHALL BE OF A MONOLITHIC (SEAMLESS AND CONTINUOUS) CONCRETE POUR AND CONTAIN NO COLD JOINTS OR HEATH SINKS (HEAT TRANSFER POINTS) ON THE BOTTOM OR SIDES TO RESIST WEATHER AND REFLECT SUNLIGHT
- VAULT SHALL HAVE COATED CONCRETE EXTERIOR TO RESIST WEATHER AND REFLECT SUNLIGHT

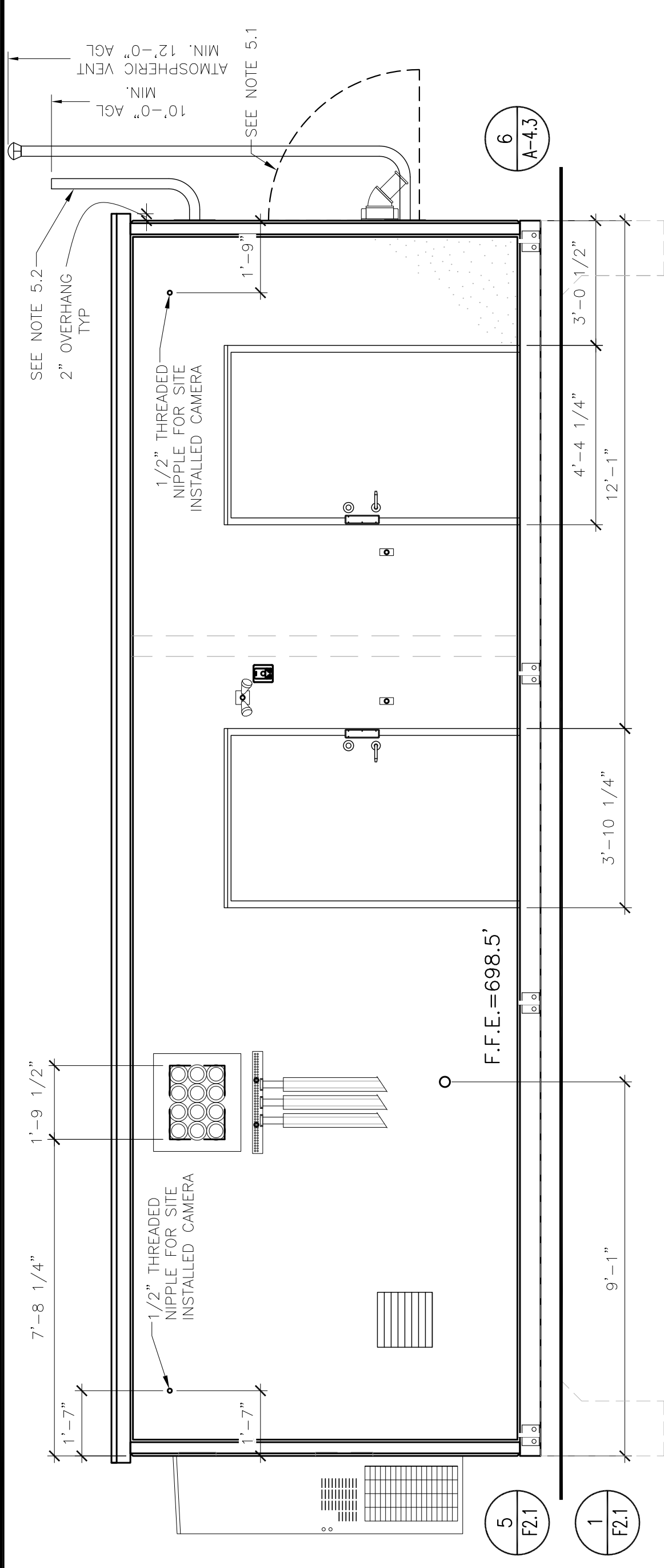

2 FRONT ELEVATION
 SCALE 3/8" = 1'-0" (22x34) 3/16" = 1'-0" (11x17)

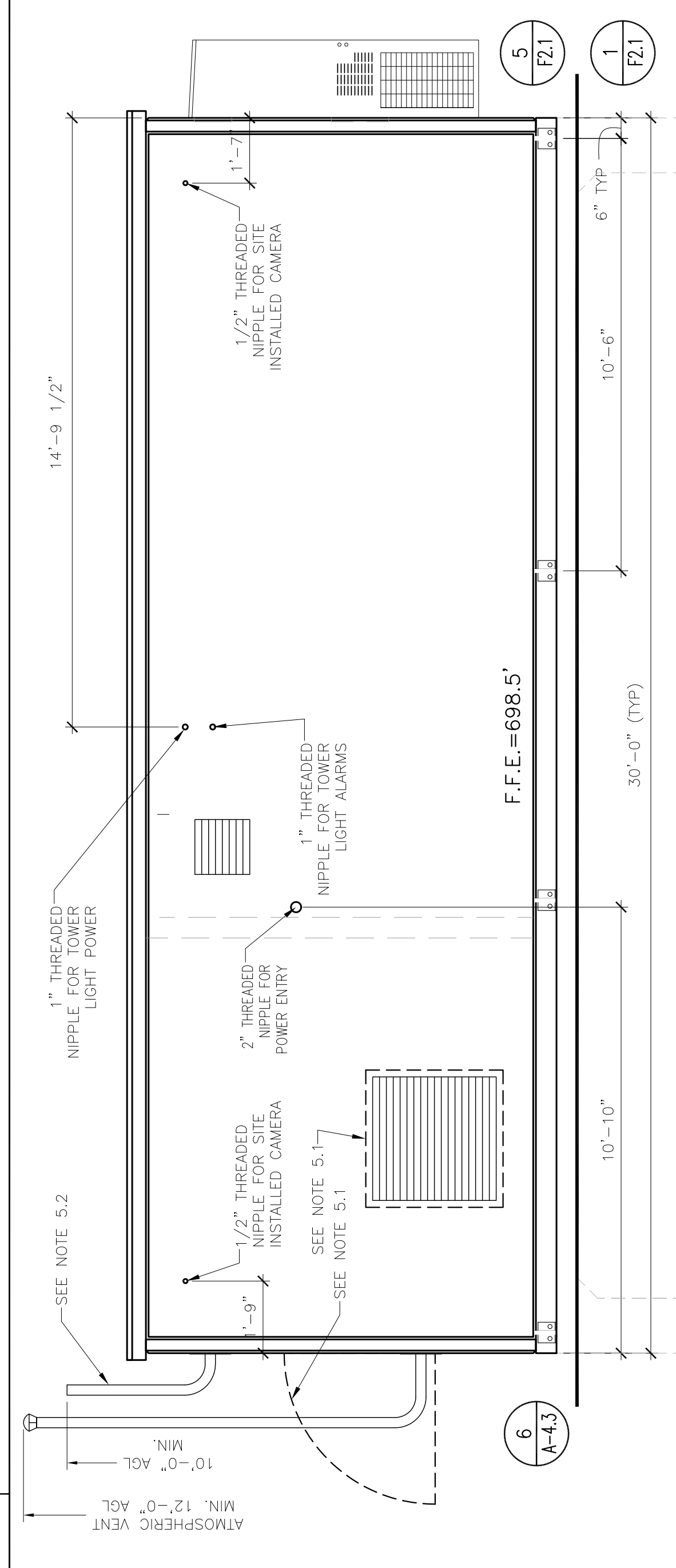

3 REAR ELEVATION
 SCALE 3/8" = 1'-0" (22x34) 3/16" = 1'-0" (11x17)

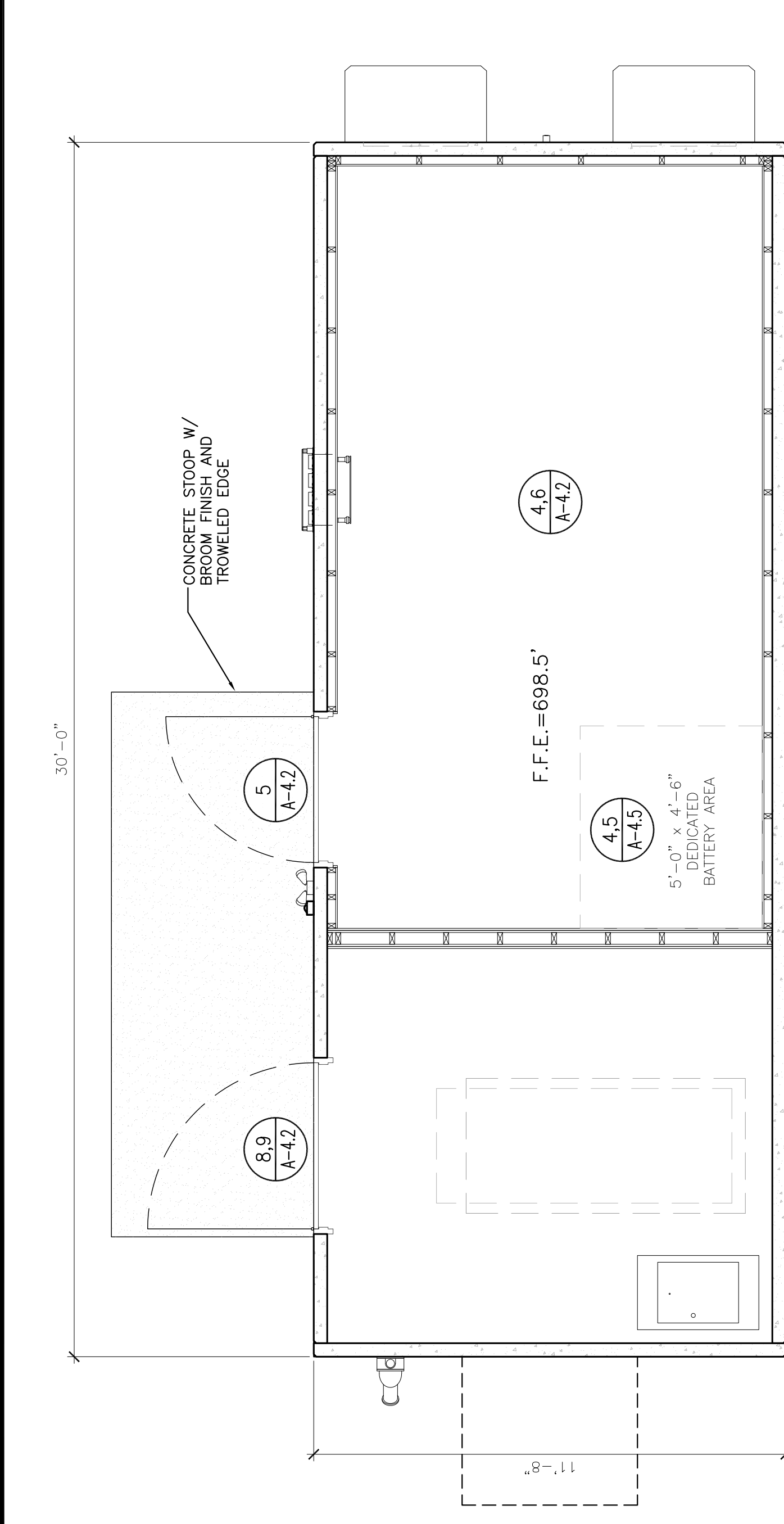

4 LEFT ELEVATION
 SCALE 3/8" = 1'-0" (22x34) 3/16" = 1'-0" (11x17)

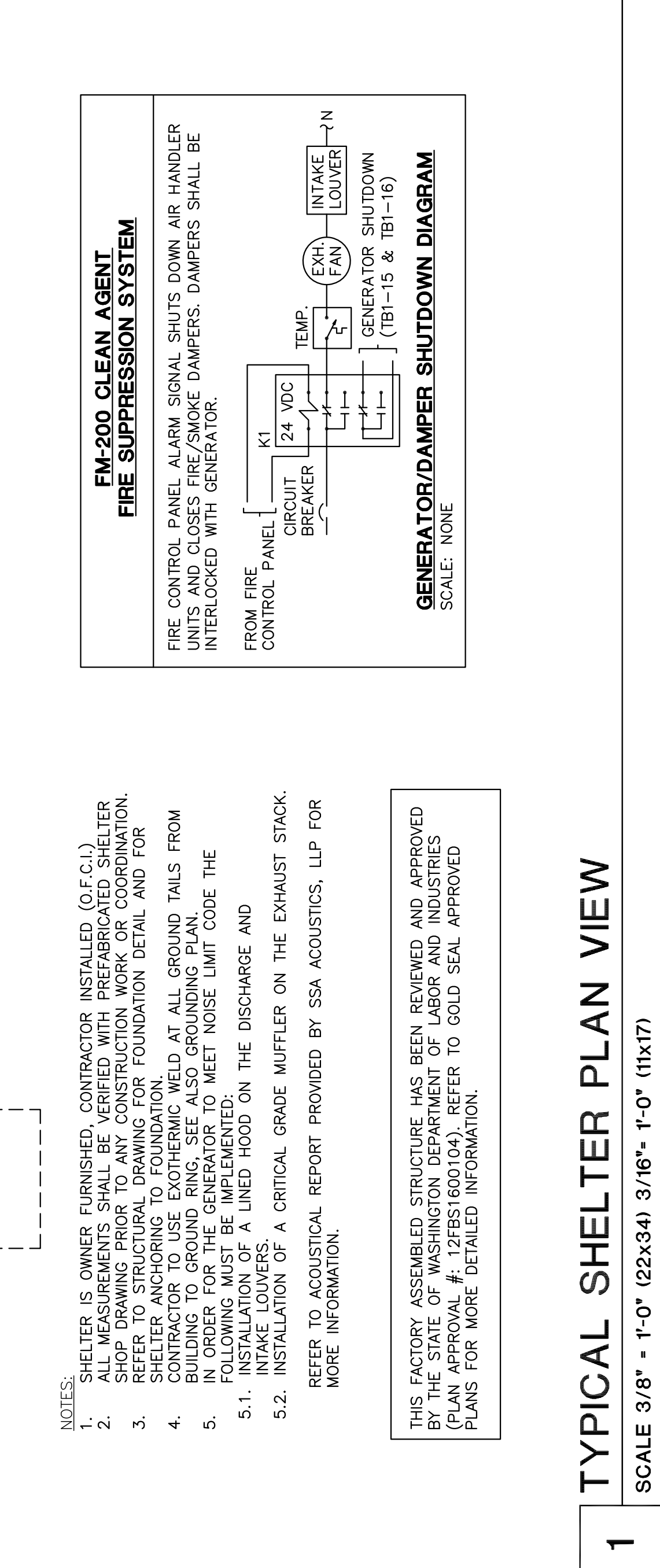

5 RIGHT ELEVATION
 SCALE 3/8" = 1'-0" (22x34) 3/16" = 1'-0" (11x17)

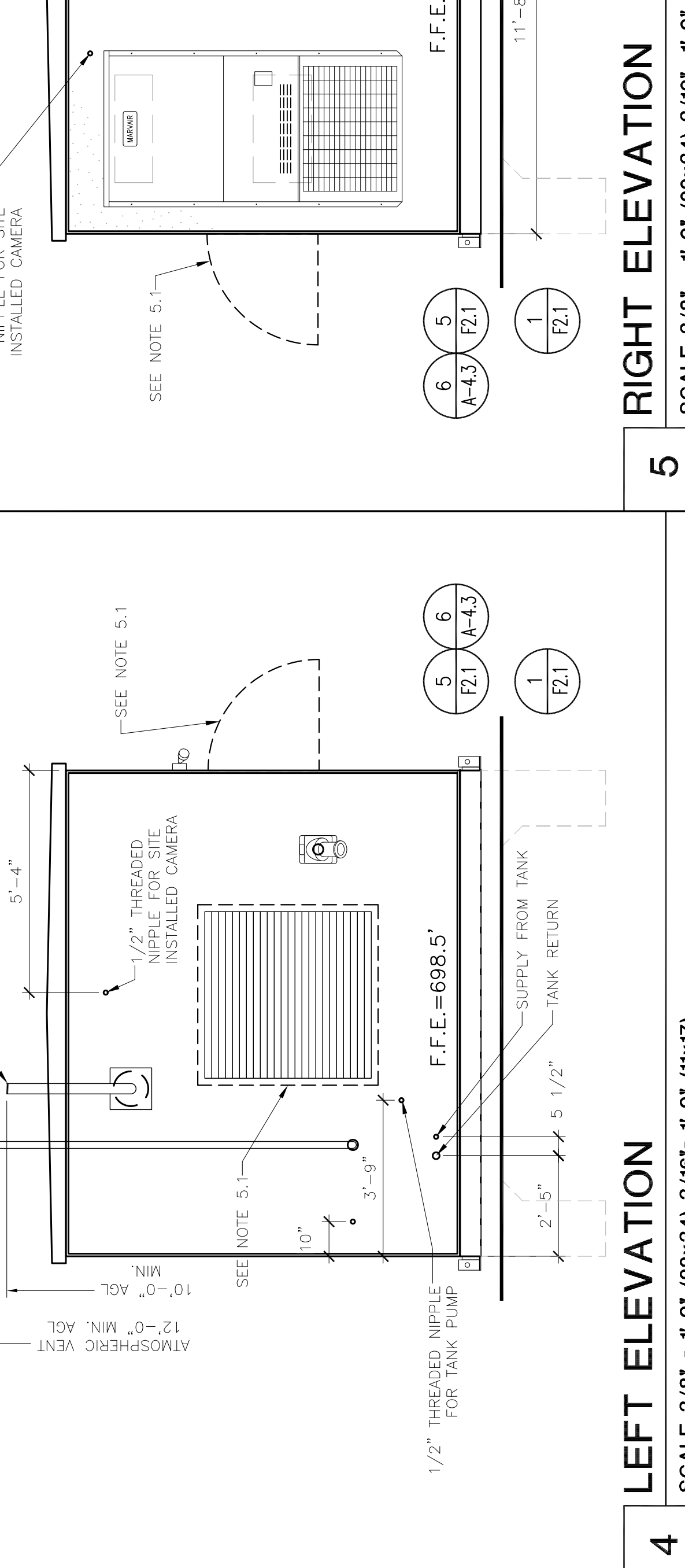

1 TYPICAL SHELTER PLAN VIEW
 SCALE 3/8" = 1'-0" (22x34) 3/16" = 1'-0" (11x17)

NOTES:
 1. SHELTER IS OWNER FURNISHED, CONTRACTOR INSTALLED. (O.F.C.I.)
 2. ALL MEASUREMENTS SHALL BE VERIFIED WITH PREFABRICATED SHELTER SHOP DRAWINGS PRIOR TO ANY CONSTRUCTION WORK OR COORDINATION. REFER TO STRUCTURAL DRAWING FOR FOUNDATION DETAIL AND FOR SHELTER ANCHORING TO FOUNDATION.
 3. CONTRACTOR TO USE EXOTHERMIC WELD AT ALL GROUND TAILS FROM BUILDING TO GROUND RING. SEE ALSO GROUNDING PLAN.
 4. IN ORDER FOR THE GENERATOR TO MEET NOISE LIMIT CODE THE FOLLOWING MUST BE IMPLEMENTED:
 5.1. INSTALLATION OF A LINED HOOD ON THE DISCHARGE AND INSTALLATION OF A CRITICAL GRADE MUFFLER ON THE EXHAUST STACK.
 5.2. REFER TO ACOUSTICAL REPORT PROVIDED BY SSA ACOUSTICS, LLP FOR MORE INFORMATION.

THIS FACTORY ASSEMBLED STRUCTURE HAS BEEN REVIEWED AND APPROVED BY THE STATE OF WASHINGTON DEPARTMENT OF LABOR AND INDUSTRIES (PLAN APPROVAL # 12FBS1600104). REFER TO GOLD SEAL APPROVED PLANS FOR MORE DETAILED INFORMATION.

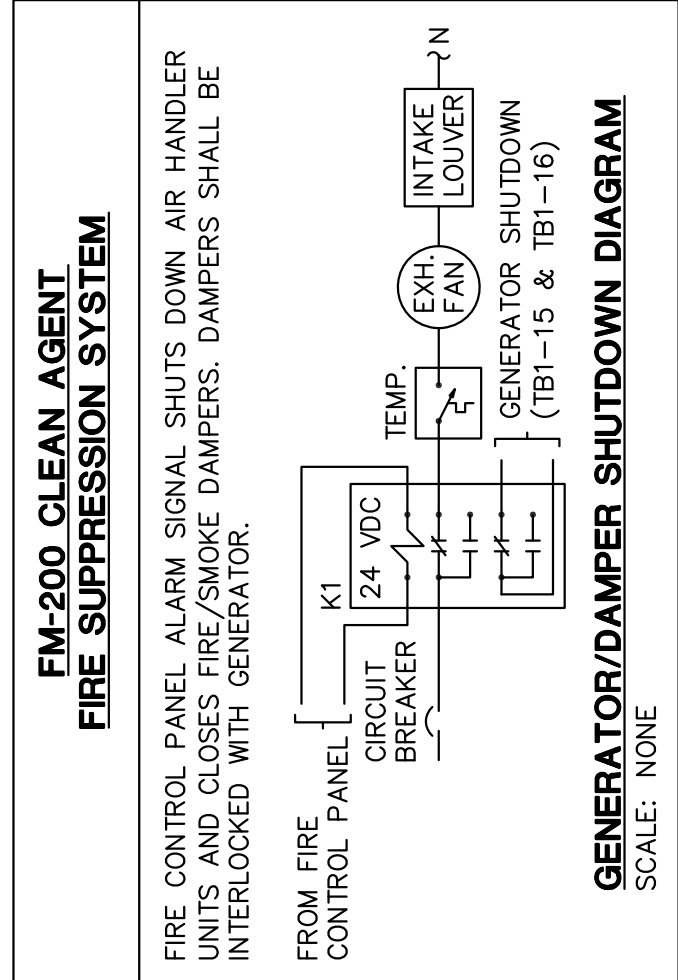

6 SHELTER ATTACHMENT
 SCALE 3/8" = 1'-0" (22x34) 3/16" = 1'-0" (11x17)

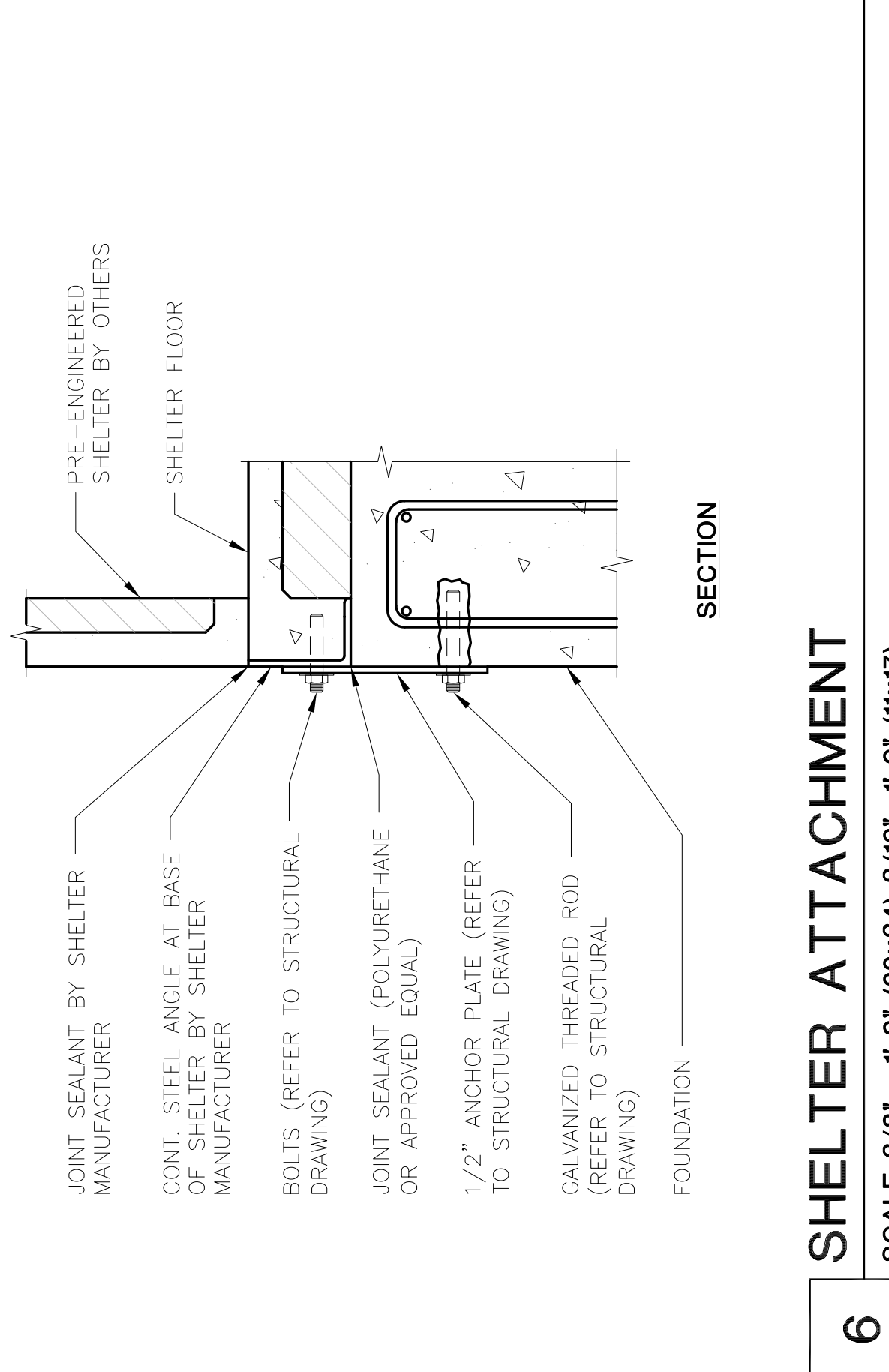



SWAN
(NEW BUILD)
39025 NE NORTH FORK RD.
DUVALL, WA 98019

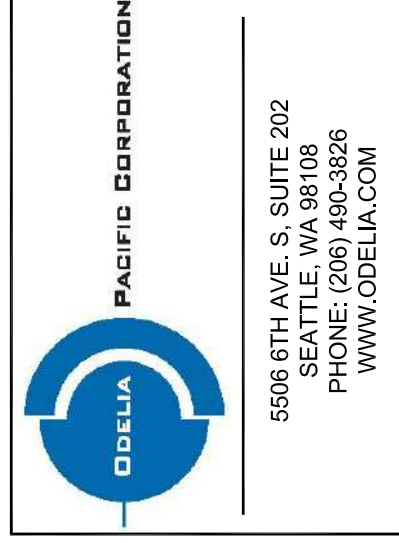

PROJECT MANAGER: EJC

PREPARED BY: AJO/EAT

APPROVED BY: PN

▲	07/31/17	UPDATED SURVEY
▲	07/21/17	DRER COMMENTS
▲	06/27/17	ELECTRICAL TIE-IN W/ SCL
▲	06/15/17	ISSUED FOR PERMIT

PLAN REVIEWERS SIGNATURE

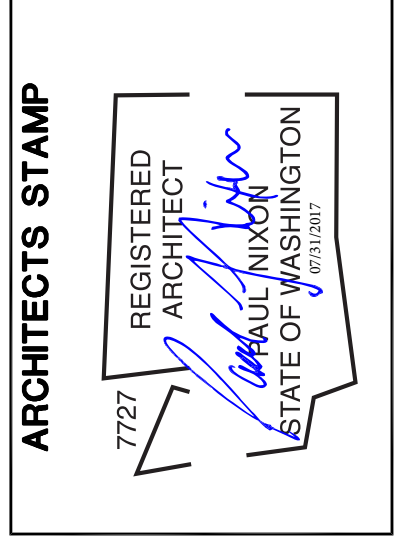

SHEET NAME
GENERATOR
DETAIL

SHEET NUMBER
A-4.4

MANUFACTURERS SPECS:

MANUFACTURER	CUMMINS
MODEL	C50 D6
DIMENSION	97.7"(L) x 40"(W) x 51.7"(H)
POWER	STANDBY KW (HZ): 50 (60)
FUEL	DIESEL
WEIGHT DRY	1434 LBS
SPL AT 23 FEET	80.9
	dB(A)

- NOTES:**
- OWNER SHALL UTILIZE ALL INTERNATIONAL FIRE CODE (IFC) FUEL CONTAINMENT MEASURES SUCH AS ENGINE FLUID CONTAINMENT ALARMS ON ALL GENERATOR LIQUIDS, AND DOUBLE WALL FUEL TANKS
 - GENERATOR MUST BE SCHEDULED TO COMPLETE MAINTENANCE OPERATION DURING DAYTIME HOURS.
 - INFORMATION OBTAINED FROM MANUFACTURER PUBLISHED DATA SHEET. CONTRACTOR TO VERIFY BEFORE ORDERING ANY PARTS.

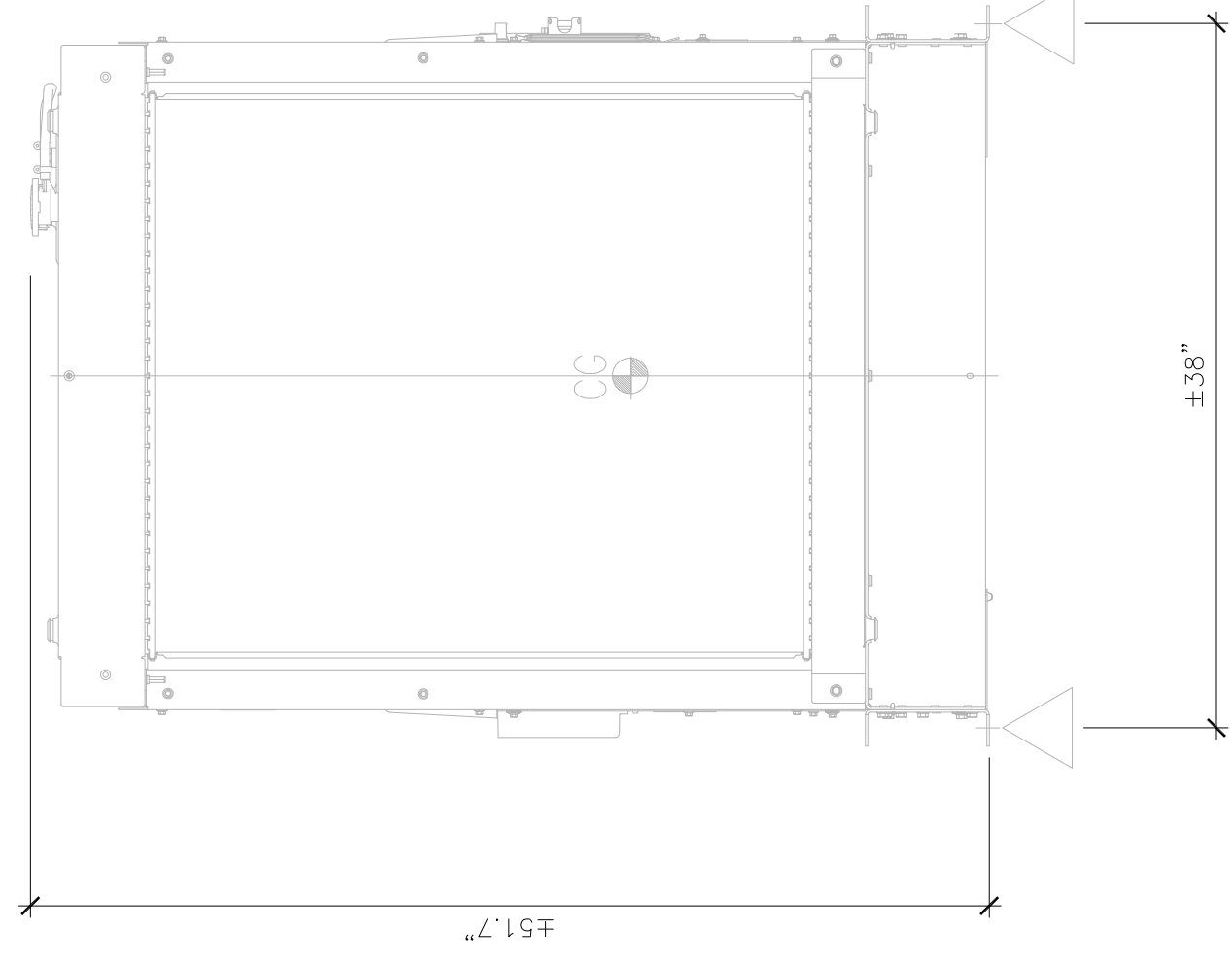
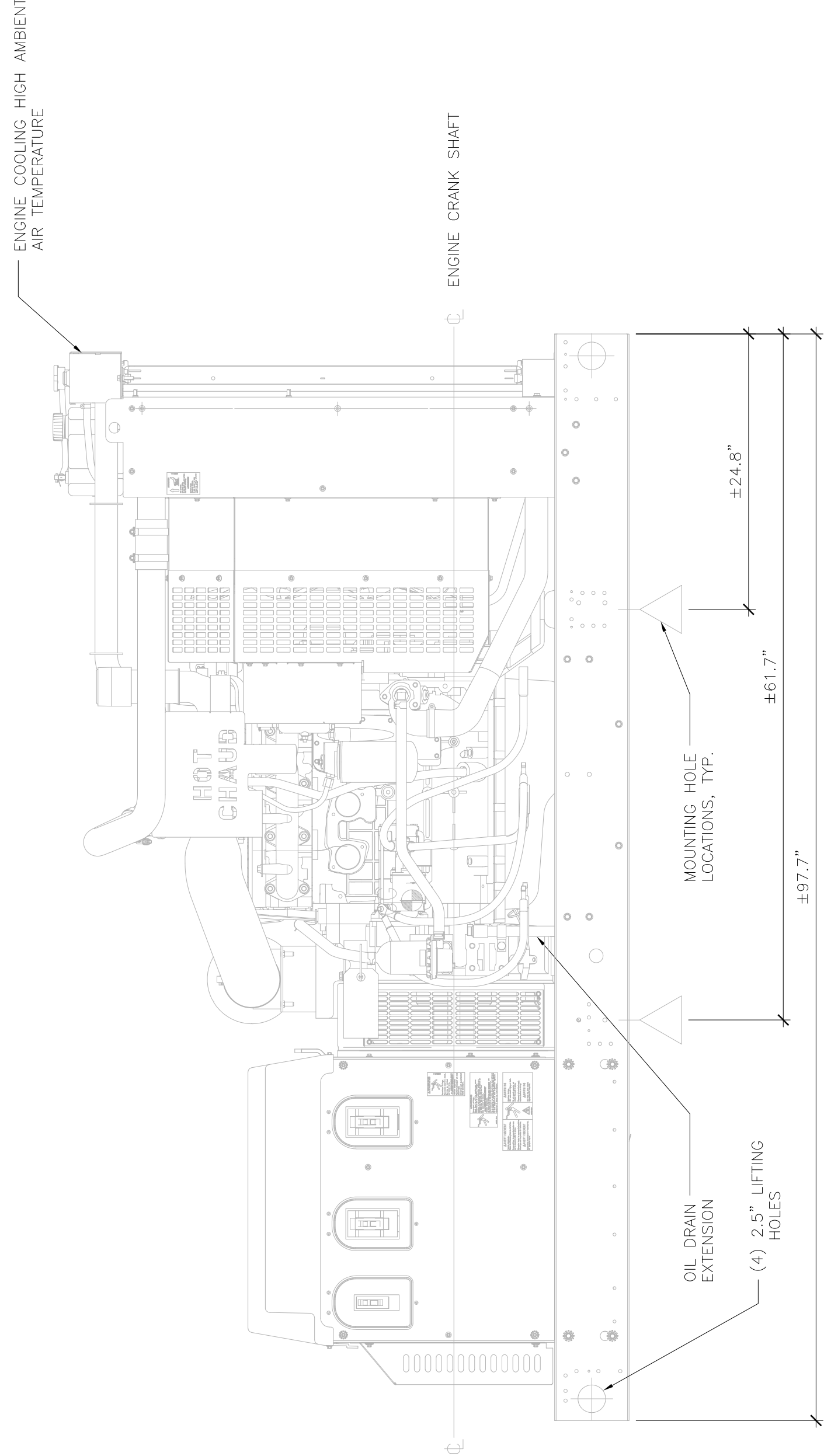
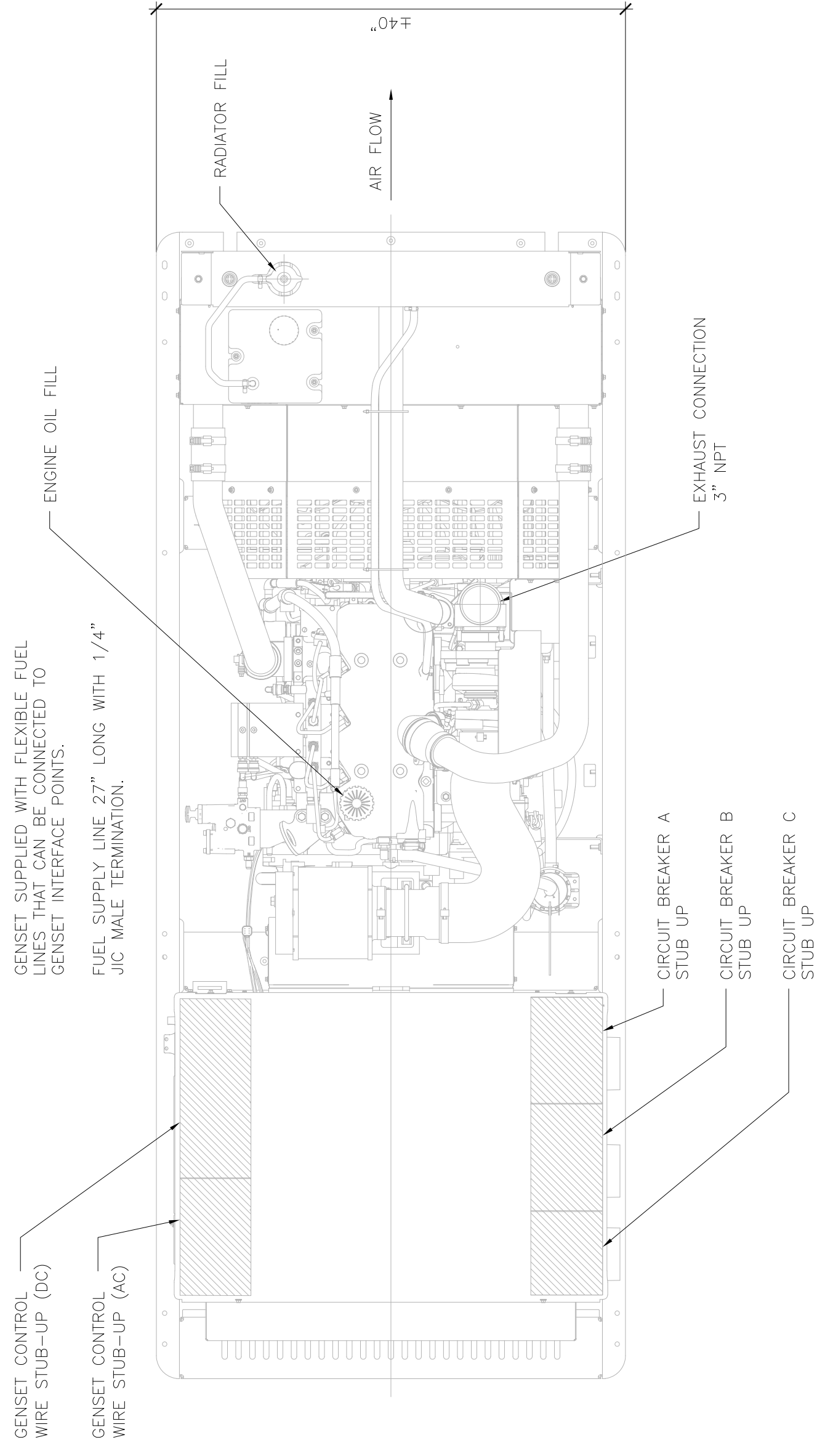

BATTERY SYSTEM DATA	
BATTERY MFG:	ENERSYS POWERSAFE DDM
BATTERY TYPE:	VRLA (VALVE REGULATED LEAD ACID)
NO. OF BATTERIES:	24 (4X X 6H)
MODEL NUMBER:	DOM65-27
NOMINAL AH CAPACITY:	1105
NON-SPELLABLE CLASSIFICATION:	UN2800
RECOGNIZED BY:	UL 1989
NO. OF CELLS PER MODULE:	1
ELECTROLYTE VOLUME PER CELL (GAL.):	3.70
ELECTROLYTE VOLUME TOTAL (GAL.):	88.8
DIMENSIONS:	48.2" W x 23.5" D x 60.8" H
TOTAL WEIGHT (CELLS AND PACK):	4,776 LBS.
CELL IS NEBS CERTIFIED	

NOTE: REFER TO DEPARTMENT OF LABOR AND INDUSTRIES -- FACTORY BUILT STRUCTURES PLANS AND CALCULATIONS FOR PROPER ROOM VENTILATION AND 1+ HOUR CONSTRUCTION SPECIFICATIONS.

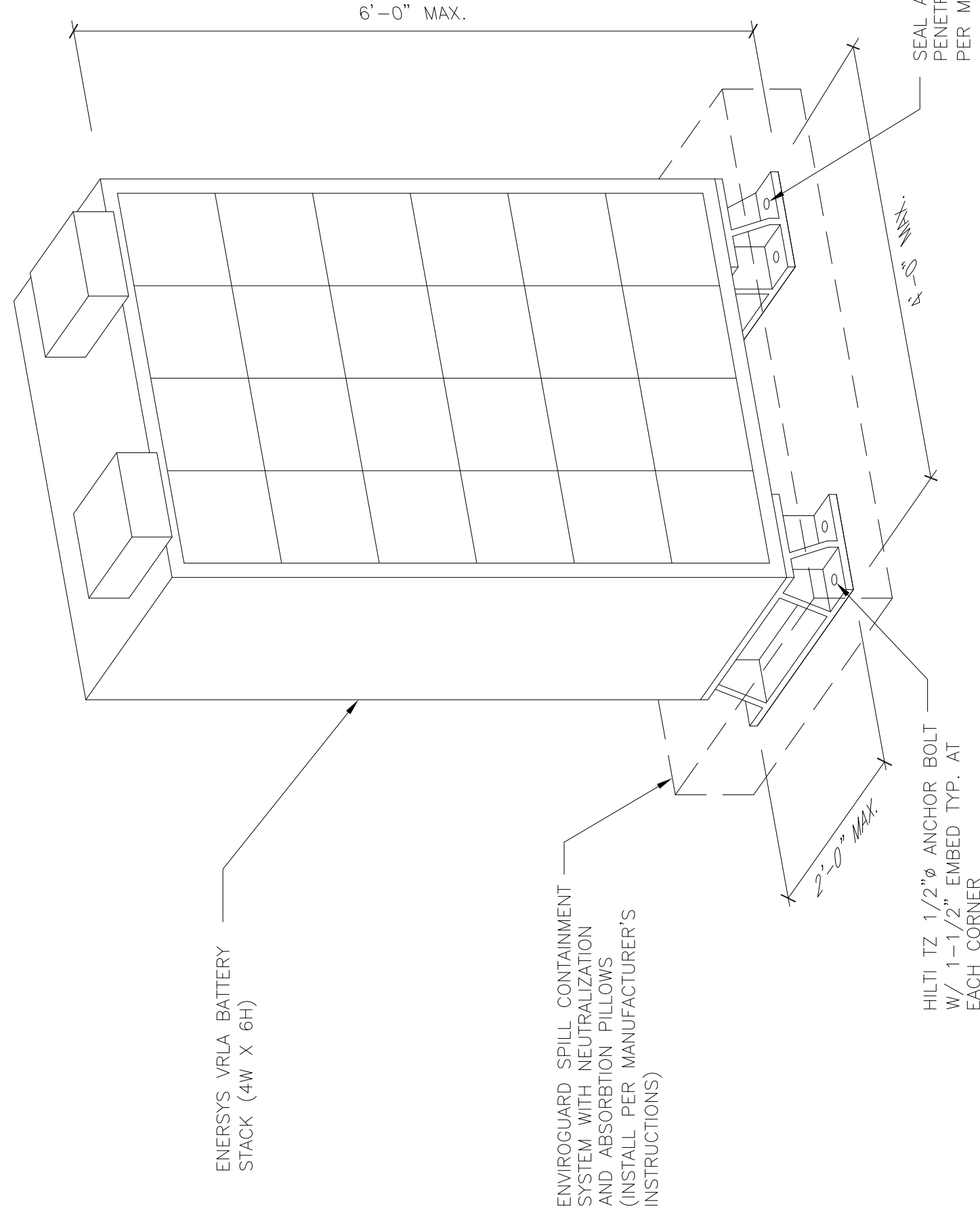

BATTERY SYSTEM

3 NOT TO SCALE

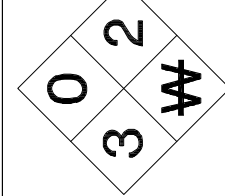

CORROSIVE LIQUIDS SIGN

4 NOT TO SCALE

Thermal Runaway Procedure Posting Attachment A to Thermal Runaway Procedure

Handling Overheating Batteries or Thermal Runaway

(A copy of this page shall be laminated or placed in a plastic sheet protector and posted in all battery areas.)

If you encounter batteries too hot to touch, that make hissing or whistling noises from their vents or:

- There is a fire or smoke
- If the fire alarms are sounding
- If there is a strong rotten egg (hydrogen sulfide) odor

Important: Take no action that could produce a spark and ignite airborne hydrogen.

If you encounter batteries too hot to touch but there is no smoke and it is safe to remain in the facility:

- Call for help
- Increase ventilation in battery area
- Reduce charge current either by turning off enough rectifiers so that the load barely is covered or by lowering the float voltage
- Increase cooling in the battery area if possible
- If there is a spill or other hazardous situation call the Environmental Hotline at 1-800-485-7900

Do not overreact to battery emergencies. Burning batteries release potentially lethal concentrations of toxic gases or other chemicals and should be handled by trained personnel in accordance with the Department with appropriate protective clothing and Self-Contained Breathing Apparatus (SCBA)

THERMAL RUNAWAY PROCEDURE

5 NOT TO SCALE

BATTERY REQUIREMENTS

REQUIREMENTS	NON-RECOMBINANT FLOODED LEAD ACID BATTERIES	FLOODED NICK-CAD (Ni-Cd) BATTERIES	VALVE REGULATED LEAD ACID (VRLA) BATTERIES	RECOMBINANT LITHIUM-ION BATTERIES
RELIEF VALVE	N/A	N/A	YES (608.2.2)	N/A
COMMENTS: RELIEF VALVE OPERATES AT 2-3 PSI AND IS COMPLETE WITH INTEGRAL FLAME ARRESTOR.				
THERMAL RUNAWAY MANAGEMENT	N/A	N/A	YES (608.3)	N/A
COMMENTS: BATTERY SYSTEM SHALL BE INSTALLED WITH BATTERY MONITORING SYSTEM (DETAIL 6/A-4.5) FOR THERMAL RUNAWAY PREVENTION AND PROTECTION. (MFR. BY CELLWATCH OR APPROVED EQUAL ACCEPTED BY THE KING COUNTY FIRE MARSHAL.)				
SPILL CONTROL	N/A	N/A	YES (N/A)	N/A
COMMENTS: PROVIDE ENVIROGUARD SPILL CONTAINMENT SYSTEM WITH NEUTRALIZATION AND ABSORBENT PILLOWS (INSTALL PER MANUFACTURER'S INSTRUCTIONS).				
NEUTRALIZATION	N/A	N/A	YES (608.2.2)	N/A
COMMENTS: NEUTRALIZATION AND ABSORBENT PILLOWS SHALL BE PROVIDED WITH ENVIROGUARD SPILL CONTAINMENT SYSTEM (INSTALL PER MANUFACTURER'S INSTRUCTIONS).				
VENTILATION	N/A	N/A	YES (608.6.1, 608.6.2)	N/A
COMMENTS: 1095 CFM EXHAUST FAN IS PROVIDED WITH SHELTER.				
SIGNAGE	N/A	N/A	YES (608.7)	N/A
COMMENTS: CODE SPECIFIED BATTERY ROOM SAFETY SIGNAGE, HAZARDOUS MATERIAL SIGNAGE (4 DIAMOND) AND THERMAL RUNAWAY PROCEDURE SIGNAGE SHALL ALL BE CLEARLY POSTED IN ALL BATTERY AREAS.				
SEISMIC PROTECTION	N/A	N/A	YES (608.8)	N/A
COMMENTS: REFER TO BATTERY SYSTEM DETAIL (3/A-4.5) FOR ANCHORAGE.				
SMOKE DETECTION	N/A	N/A	YES (608.9)	N/A
COMMENTS: AUTOMATIC SMOKE DETECTION AND FIRE SUPPRESSION SYSTEM (FM-200) TO BE INSTALLED.				
NOTE: CODE REFERENCES ARE TO 2015 INTERNATIONAL FIRE CODE FOR STATIONARY STORAGE BATTERY SYSTEMS.				

BATTERY REQUIREMENTS

1

Cell Level Battery Monitoring
Cellwatch Frontier measures voltage and ohmic resistance of each cell as well as the temperature and DC current to provide a complete picture of battery health.

Cell Level Alarms
Frontier triggers alarms when any value is beyond acceptable limits, including an increase in a battery's internal resistance. Alarms are sent to device LEDs, site web pages and centralized network management systems.

Flexible and Scalable
With its modular architecture, Cellwatch Frontier is designed to be scaled from a single rack to a combination of 2 to 16 racks. Installers can customize the setup to reflect the variation from site to site, accommodating deployment deviations as they arise.

Reliable and Economical
The Cellwatch Frontier components were designed to have an extremely long life and the major components of the solution have a mean time between failures (MTBF) of almost 30 years. The Cellwatch Frontier system is highly reliable and provides an extremely high return on investment.

Cellwatch Frontier systems are composed of five major components: a battery cabinet, a Cellwatch Frontier (DCM) DCMs are connected to each cell and measure its voltage and ohmic value. DCMs are networked with the Frontier device via fiber optic cable for electrical isolation and safety. The Frontier unit provides a complete picture of the health of all the cells in the battery plant at a site. Cellwatch Frontier integrates with site or network management systems (NMS) to provide a complete view of the battery health across all the distributed sites.

Cellwatch's unique testing method has no impact on the cell's capacity and no impact on the cell's useful life.

BATTERY MONITORING SYSTEM

6

King County

PSERN

PUGET SOUND EMERGENCY RADIO NETWORK

Coverage • Capacity • Capability • Connectivity

SWAN

(NEW BUILD)

39025 NE NORTH FORK RD.
DUVALL, WA 98019

DEBIA PACIFIC CORPORATION

5606 6TH AVE S, SUITE 202
SEATTLE, WA 98108
PHONE: (206) 490-3826
WWW.DEBIA.COM

CAMP+ ASSOCIATES

19401 40TH AVE. W, SUITE 304
LYNNWOOD, WA 98036
PHONE: (425) 740-6392
FAX: (425) 252-2860
WWW.CAMPASSOC.COM

PROJECT MANAGER: EJC

PREPARED BY: AIO/EAT

APPROVED BY: PN

Δ	07/31/17	UPDATED SURVEY
Δ	07/21/17	PIPER COMMENTS
Δ	06/27/17	ELECTRICAL TIE-IN W/ SCL
Δ	06/15/17	ISSUED FOR PERMIT

PLAN REVIEWERS SIGNATURE

ARCHITECTS STAMP

7/27
REGISTERED ARCHITECT
PAUL NIXON
STATE OF WASHINGTON
0711-2017

SHEET NAME

BATTERY SYSTEM

SHEET NUMBER

A-4.5

NOT USED

2

STRUCTURAL NOTES FOR BUILDING & FUEL TANK FOUNDATIONS

(THESE NOTES ARE TYPICAL UNLESS NOTED OR DETAILED OTHERWISE ON DRAWINGS)

CODE

ALL MATERIALS, WORKMANSHIP, DESIGN, AND CONSTRUCTION SHALL CONFORM TO THE DRAWINGS, SPECIFICATIONS, AND THE INTERNATIONAL BUILDING CODE (IBC), 2015 EDITION, SPECIFICATIONS AND STANDARDS WHERE REFERENCED ON THE DRAWINGS ARE TO BE THE LATEST EDITION.

DESIGN LOADS

DEAD LOADS:
BUILDING WEIGHT
FUEL TANK
100.5 KIPS (80 KIPS SELF WT + 20.5 KIPS EQUIPMENT)
25.5 KIPS (18 KIPS SELF WT + 7.5K)

LIVE LOADS:
ROOF (SNOW LOAD)
ROOF (WIND MER)
150 PSF (PER MFR)
100 PSF (PER MFR)

(LIVE LOADS ARE REDUCED WHERE PERMISSIBLE PER IBC SECTION 1607.10).

EARTHQUAKE LOADS:

SITE CLASS (ASSUMED)
SHORT PERIOD SPECTRAL RESPONSE ACCEL (S)
ONE SECOND SPECTRAL RESPONSE ACCEL (S)
SHORT PERIOD DESIGN SPECTRAL RESPONSE ACCEL (S_{0.5})
ONE SECOND DESIGN SPECTRAL RESPONSE ACCEL (S_{1.0})
RISK CATEGORY
SEISMIC IMPORTANCE FACTOR (I)
SEISMIC DESIGN CATEGORY

D 1.124
0.425
0.787
0.447
IV
1.5
D

WIND LOADS:

BASIC WIND SPEED (3 SECOND GUST)
EXPOSURE
K_z
115 MPH
B
1.0

SEE PLANS FOR ADDITIONAL DESIGN LOADS.

STATEMENT OF SPECIAL INSPECTIONS

SPECIAL INSPECTIONS ARE REQUIRED AS INDICATED IN THE FOLLOWING TABLE. THE CONTRACTOR SHALL SUBMIT A WRITTEN STATEMENT OF RESPONSIBILITY TO THE BUILDING OFFICIAL AND OWNER PRIOR TO COMMENCEMENT OF WORK IN ACCORDANCE WITH CHAPTER 1704.4 OF THE IBC.

FREQUENCY AND DISTRIBUTION OF REPORTS - INSPECTION REPORTS SHALL BE PROVIDED FOR EACH DAY ON SITE BY SPECIAL INSPECTOR. STRUCTURAL OBSERVATION REPORTS SHALL BE PROVIDED AFTER EACH OBSERVATION. REPORTS SHALL BE DISTRIBUTED TO THE CONTRACTOR, ARCHITECT, ENGINEER AND BUILDING OFFICIAL.

SPECIAL INSPECTION

OPERATION	CONT	PERIODIC	REMARKS
SOILS			
EXCAVATION & FILL		X	GEOTECH ENGINEER
FOUNDATION BEARING CAPACITY VERIFICATION		X	
CONCRETE			
REINFORCING PLACEMENT		X	
ANCHOR BOLTS		X	
CONCRETE PLACEMENT	X		
EXPANSION ANCHORS		X	
TESTING FOR FC, AIR CONTENT, SLUMP	X		IF RECID

NOTE:
ALL ITEMS MARKED WITH AN "X" SHALL BE INSPECTED IN ACCORDANCE WITH IBC CHAPTER 17. SPECIAL INSPECTION SHALL BE PERFORMED BY A QUALIFIED TESTING AGENCY DESIGNATED BY THE OWNER. THE CONTRACTOR SHALL BE RESPONSIBLE FOR THE COST OF ALL SPECIAL INSPECTIONS. ALL SPECIAL INSPECTIONS SHALL BE PERFORMED WITHIN THE TIME FRAME OF ALL RESULTS. ANY INSPECTION FAILING TO MEET THE PROJECT SPECIFICATIONS SHALL BE IMMEDIATELY BROUGHT TO THE ATTENTION OF THE DESIGN TEAM.

FOUNDATIONS:

SOILS REPORT:
NO: 114-5710384A
BY: TETRATECH
DATED: APRIL 15, 2016

ALLOWABLE SOIL PRESSURE: 4000 PSF

PASSIVE EARTH PRESSURE: 350 PSF
COEFFICIENT OF FRICTION: 0.45
ACTIVE PRESSURE: 55 PCF

FOOTINGS SHALL BEAR ON FIRM UNDISTURBED EARTH OR ENGINEERED GRAVEL FILL AS REQUIRED AND AT LEAST 18" BELOW ADJACENT EXTERIOR GRADE. ANY FOOTING ELEVATIONS SHOWN IN THE DRAWINGS REPRESENT MINIMUM DEPTHS AND ARE FOR BIDDING ONLY. ACTUAL FOOTING ELEVATIONS ARE SUBJECT TO SITE CONDITIONS AND MUST THEREFORE BE ESTABLISHED BY THE CONTRACTOR. FOOTINGS SHALL BE CENTERED BELOW COLUMNS OR WALLS ABOVE, UNLESS NOTED OTHERWISE.

IMPORTED STRUCTURAL FILL AND BACKFILL MATERIAL SHOULD CONSIST OF CLEAN, WELL GRADED GRANULAR MATERIAL FREE OF DEBRIS OR ORGANICS WITH A MAXIMUM PARTICLE DIAMETER OF THREE INCHES AND NO MORE THAN 10% FINES (PASSING THE #200 SIEVE).

FILL AND BACKFILL MATERIAL SHOULD BE PLACED IN LEVEL LIFTS NOT EXCEEDING TWELVE (12") INCHES IN LOOSE THICKNESS AND COMPACTED TO A MINIMUM OF 98% OF ITS MAXIMUM DRY DENSITY AS DETERMINED BY ASTM TEST METHOD D1557-00.

EXCAVATIONS AND DRAINAGE INSTALLATION SHALL BE OBSERVED BY A SOILS ENGINEER RETAINED BY THE OWNER. IF EXCAVATION SHOWS SOIL CONDITIONS TO BE OTHER THAN THOSE ASSUMED ABOVE NOTIFY THE STRUCTURAL ENGINEER FOR POSSIBLE FOUNDATION REDESIGN.

CONCRETE

ALL CONCRETE SHALL BE MIXED, PROPORTIONED, CONVEYED, AND PLACED IN ACCORDANCE WITH ACI 318 AND THE AMERICAN CONCRETE INSTITUTE'S SPECIFICATIONS FOR STRUCTURAL CONCRETE FOR BUILDINGS (ACI 301).

ALL CONCRETE SHALL BE STONE-AGGREGATE CONCRETE HAVING A UNIT WEIGHT OF APPROXIMATELY 150 POUNDS PER CUBIC FOOT.

CONCRETE STRENGTHS AT 28 DAYS (F_c) AND MIX CRITERIA SHALL BE AS FOLLOWS:

TYPE OF CONSTRUCTION	F _c	MAXIMUM WATER/CEMENT RATIO	MIN CEMENT CONTENT PER CUBIC YARD	MAXIMUM SHRINKAGE STRAIN
SLABS ON GRADE	5000 PSI	0.55	5 1/2 SACK	N/A
FOOTINGS	5000 PSI	0.55	5 1/2 SACK	N/A
GRADE BEAMS	5000 PSI	0.55	5 1/2 SACK	N/A
ALL OTHER CONC.	5000 PSI	0.55	5 SACK	N/A

THE MINIMUM AMOUNT OF CEMENT LISTED ABOVE MAY BE CHANGED IF A CONCRETE PERFORMANCE MIX IS SUBMITTED TO THE ENGINEER AND THE BUILDING DEPARTMENT FOR APPROVAL TWO WEEKS PRIOR TO PLACING ANY CONCRETE. THE PERFORMANCE MIX SHALL INCLUDE THE AMOUNTS OF CEMENT, FINE AND COARSE AGGREGATE, WATER, AND ADMIXTURES AS WELL AS THE WATER-CEMENT RATIO, SLUMP, CONCRETE YIELD, AND SUBSTANTIATING STRENGTH DATA IN ACCORDANCE WITH ACI 318.

ALL CONCRETE EXPOSED TO WEATHER OR TO FREEZING TEMPERATURES SHALL BE AIR-ENTRAINED AND MEET REQUIREMENTS IN ACCORDANCE WITH ACI 318 TABLE 19.3.2.1 FOR EXPOSURE CATEGORIES F2, S0, W10, & C0.

REINFORCING STEEL

REINFORCING STEEL SHALL BE DEFORMED BILLET STEEL CONFORMING TO ASTM A615, AND SHALL BE GRADE 60 (F_y = 60,000 PSI), UNLESS NOTED OTHERWISE. GRADE 60 REINFORCING BARS INDICATED ON DRAWINGS TO BE WELDED SHALL CONFORM TO ASTM A706. REINFORCING COMPLYING WITH ASTM A615 MAY BE WELDED IF MATERIAL PROPERTY REPORTS INDICATING CONFORMANCE WITH WELDING PROCEDURES SPECIFIED IN AWS D1.4 ARE SUBMITTED.

WELDED WIRE FABRIC SHALL CONFORM TO ASTM A185. PROVIDE WELDED WIRE FABRIC IN SHEETS NOT ROLLS. LAP WELDED WIRE FABRIC 12" AT SIZES AND ENDS.

REINFORCING STEEL SHALL BE DETAILED INCLUDING HOOKS AND BENDS IN ACCORDANCE WITH SP-66 AND ACI 318R, LATEST EDITIONS, UNLESS OTHERWISE NOTED. REINFORCING SPICE LENGTHS AND DEVELOPMENT LENGTHS SHALL BE PER SCHEDULE.

MECHANICAL SPICING OF REINFORCING BARS, WHERE INDICATED ON THE DRAWINGS, SHALL BE BY AN IBCO APPROVED SYSTEM. SHALL DEVELOP 125% OF THE SPECIFIED YIELD STRENGTH OF THE BAR, AND SHALL BE INSTALLED IN ACCORDANCE WITH THE MANUFACTURER'S RECOMMENDATIONS.

REINFORCING SHALL BE PLACED AND ADEQUATELY SUPPORTED PRIOR TO PLACING CONCRETE. WET-SETTING EMBEDDED ITEMS IS NOT ALLOWED WITHOUT PRIOR ENGINEER APPROVAL. BARS PARTIALLY EMBEDDED IN HARDENED CONCRETE SHALL NOT BE FIELD BENT UNLESS SO DETAILED OR APPROVED BY THE STRUCTURAL ENGINEER. REFER TO CHAPTER 7 OF ACI 318 FOR OTHER REINFORCING STEEL REQUIREMENTS.

MINIMUM LAPS AND EMBEDMENT

UNLESS OTHERWISE NOTED, REINFORCING SPICE LENGTHS AND DEVELOPMENT LENGTHS SHALL BE AS TABULATED BELOW:

BAR SIZE	DEVELOPMENT LENGTH		LAP SPICE		COMPRESSION	
	TENSION	OTHER BARS	TENSION			
			ALL BARS	TOP BARS		OTHER BARS
#3	17	13	7	22	17	12
#4	23	17	9	29	23	15
#5	28	22	11	36	28	19
#6	34	26	13	43	34	23
#7	49	38	15	63	49	27
#8	56	43	17	72	56	30

NOTE:
1. ALL LENGTHS ARE IN INCHES.
2. ALL LAP SPICES ARE CLASS B.
3. TOP BARS ARE HORIZONTAL REINFORCEMENT PLACED SUCH THAT MORE THAN 12 INCHES OF CONCRETE IS CAST IN THE MEMBER BELOW THE BAR.

CONCRETE COVER ON REINFORCING

CONCRETE CAST AGAINST AND PERMANENTLY EXPOSED TO EARTH:

CONCRETE EXPOSED TO EARTH AND WEATHER:

#6 BARS AND LARGER

#5 BARS AND SMALLER

CONCRETE NOT EXPOSED TO EARTH OR WEATHER:

SLABS, WALLS AND JOISTS

COLUMN TIES OR SPIRALS AND BEAM STIRRUPS

CONCRETE GENERAL NOTES

VERTICAL BARS SHALL START FROM TOP OF FOOTING. HORIZONTAL BARS SHALL START A DISTANCE OF 1/2 THE NORMAL BAR SPACING FROM TOP OF FOOTING AND TOP OF FRAMED SLABS. IN ADDITION, THERE SHALL BE A HORIZONTAL BAR AT A MAXIMUM OF 3" FROM TOP OF WALL AND BOTTOM OF FRAMED SLABS.

PROVIDE CORNER BARS TO MATCH THE HORIZONTAL REINFORCING WITH TENSION LAP SPICE AT EACH SIDE PER TABLE, OR BEND ONE SIDE OVER TO PROVIDE TENSION LAP.

PROVIDE CONTROL OR CONSTRUCTION JOINTS IN SLABS ON GRADE TO BREAK LAP SLAB INTO RECTANGULAR AREAS OF NOT MORE THAN 400 SQUARE FEET EACH. AREAS TO BE AS SQUARE AS PRACTICAL, AND HAVE NO ACUTE ANGLES. JOINT LOCATIONS TO BE APPROVED BY THE ARCHITECT.

ALL CONSTRUCTION JOINTS SHALL BE THOROUGHLY CLEANED AND PROPERLY PREPARED IMMEDIATELY PRIOR TO POURING OF CONCRETE. DOWEL STEEL SHALL BE THE SAME SIZE AND SPACING AS MAIN REINFORCING DETAILED BEYOND JOINT.

SEE ARCHITECTURAL DRAWINGS AND MECHANICAL DRAWINGS FOR EXACT LOCATIONS AND DIMENSIONS OF OPENINGS IN CONCRETE WALLS, FLOORS AND ROOF. UNLESS INDICATED OTHERWISE, REINFORCE AROUND OPENINGS GREATER THAN 12" IN EITHER DIRECTION WITH (2) #5 EACH SIDE AND (1) #5 X 4"-0" DIAGONAL AT EACH CORNER. EXTEND BARS 2'-0" BEYOND EDGE OF OPENING. IF 2'-0" IS UNAVAILABLE, EXTEND AS FAR AS POSSIBLE AND HOOK. HOOK ALL REINFORCING INTERRUPTED BY OPENINGS.

BARS PARTIALLY EMBEDDED IN HARDENED CONCRETE SHALL NOT BE FIELD BENT UNLESS SO DETAILED OR APPROVED BY THE STRUCTURAL ENGINEER.

SEE ARCHITECTURAL DRAWINGS FOR ALL GROOVES, NOTCHES, CHAMFERS, FEATURE STRIPS, COLOR, TEXTURE AND OTHER FINISH DETAILS AT ALL EXPOSED CONCRETE SURFACES. PROVIDE 3/4" CHAMFER AT ALL CORNERS EXCEPT AS NOTED.

STRUCTURAL STEEL

STRUCTURAL STEEL DESIGN, FABRICATION AND ERECTION SHALL BE IN ACCORDANCE WITH THE AISC "SPECIFICATION FOR THE DESIGN, FABRICATION, AND ERECTION OF STRUCTURAL STEEL FOR BUILDINGS", LATEST EDITION.

SHAPES SHALL CONFORM TO ASTM A992, F_y = 50 KSI.

PLATES, ANGLES, AND RODS SHALL CONFORM TO ASTM A36, F_y = 36 KSI.

STRUCTURAL TUBING SHALL CONFORM TO ASTM A500 GRADE B, F_y = 46 KSI.

STEEL PIPE SHALL CONFORM TO ASTM A53 GRADE B, F_y = 35 KSI.

BOLTS CONNECTING STEEL MEMBERS SHALL CONFORM TO ASTM A325-N. BOLTS SHALL BE 3/4"-Ø MINIMUM, UNO ANCHOR BOLTS SHALL CONFORM TO ASTM A307.

CONTRACTOR SHALL PROVIDE CONNECTION ADJUSTMENT TOLERANCES TO SATISFY THE REQUIREMENTS OF AISC MANUAL OF STEEL CONSTRUCTION.

UNLESS SPECIFIED AS STAINLESS STEEL, ALL STEEL MEMBERS, SHAPES, BOLTS, AND ACCESSORIES EXPOSED TO WEATHER SHALL BE HOT DIP GALVANIZED.

WELDING

WELDING SHALL CONFORM TO AWS "STRUCTURAL WELDING CODE", LATEST EDITION. ALL WELDING SHALL BE DONE WITH 70 KSI LOW HYDROGEN ELECTRODES, WHERE NOT CALLED OUT, MINIMUM FILLET WELD SIZE SHALL BE PER TABLE 5.8 IN AWS D1.1, LATEST EDITION.

WELDING OF REINFORCING BARS SHALL NOT BE PERMITTED UNLESS SPECIFICALLY CALLED OUT ON DRAWINGS OR APPROVED BY STRUCTURAL ENGINEER. WELDING OF GRADE 60 REINFORCING BARS SHALL BE PERFORMED USING LOW HYDROGEN ELECTRODES. WELDING OF GRADE 60 REINFORCING BARS SHALL BE PERFORMED USING E70XX ELECTRODES. SEE REINFORCING NOTES FOR MATERIAL REQUIREMENTS OF WELDED BARS. WELDING WITHIN 4" OF COLD BENDS IN REINFORCING BARS IS NOT PERMITTED.

ALL WELDING SHALL BE DONE BY WASHINGTON ASSOCIATION OF BUILDING OFFICIALS (WABO) CERTIFIED WELDERS.

EXISTING BUILDING

CONTRACTOR SHALL VERIFY ALL DIMENSIONS, MEMBER SIZES AND CONDITIONS OF THE EXISTING BUILDING DEPICTED IN THE DRAWINGS, AND NOTIFY THE STRUCTURAL ENGINEER OF ANY DISCREPANCIES FOR POSSIBLE REDESIGN.

CONTRACTOR RESPONSIBLE FOR COMPLETELY SEALING ALL AREAS WHERE EXISTING ROOF MATERIAL IS PENETRATED OR REMOVED. PROVIDE WATER PROOFING AS REQUIRED BY THE ARCH.

GENERAL

STRUCTURAL DRAWINGS SHALL BE USED IN CONJUNCTION WITH ARCHITECTURAL, CIVIL, ELECTRICAL, AND MECHANICAL DRAWINGS FOR BIDDING AND CONSTRUCTION. CONTRACTOR SHALL VERIFY ALL DIMENSIONS AND CONDITIONS FOR COMPATIBILITY BEFORE PROCEEDING. ANY DISCREPANCIES SHALL BE BROUGHT TO THE ATTENTION OF THE ARCHITECT BEFORE PROCEEDING.

CONTRACTOR TO SEE ARCHITECTURAL, CIVIL, ELECTRICAL AND MECHANICAL DRAWINGS FOR SIZE AND LOCATION OF PIPE, VENT, DUCT AND OTHER OPENINGS AND DETAILS NOT SHOWN ON THESE DRAWINGS.

CONTRACTOR SHALL BE RESPONSIBLE FOR ERECTION STABILITY AND TEMPORARY SHORING AS NECESSARY UNTIL PERMANENT SUPPORT AND STIFFENING ARE INSTALLED.

CONTRACTOR-INITIATED CHANGES SHALL BE SUBMITTED IN WRITING TO THE ARCHITECT AND STRUCTURAL ENGINEER FOR APPROVAL PRIOR TO FABRICATION OR CONSTRUCTION. CHANGES SHOWN ON SHOP DRAWINGS ONLY WILL NOT SATISFY THIS REQUIREMENT.

DRAWINGS INDICATE GENERAL AND TYPICAL DETAILS OF CONSTRUCTION. WHERE CONDITIONS ARE NOT SPECIFICALLY INDICATED BUT ARE OF A SIMILAR CHARACTER TO DETAILS SHOWN, SIMILAR DETAILS OF CONSTRUCTION SHALL BE USED, SUBJECT TO REVIEW AND APPROVAL BY THE ARCHITECT AND THE STRUCTURAL ENGINEER.

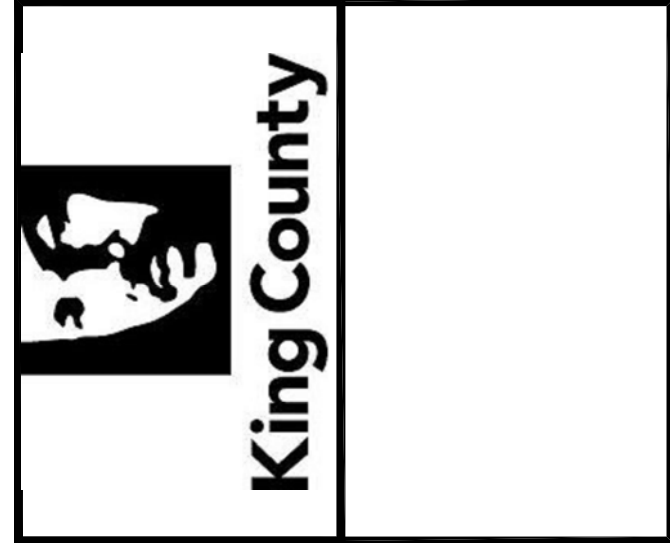

SWAN
(NEW BUILD)
39025 NE NORTH FORK RD.
DUWALL WA 98019

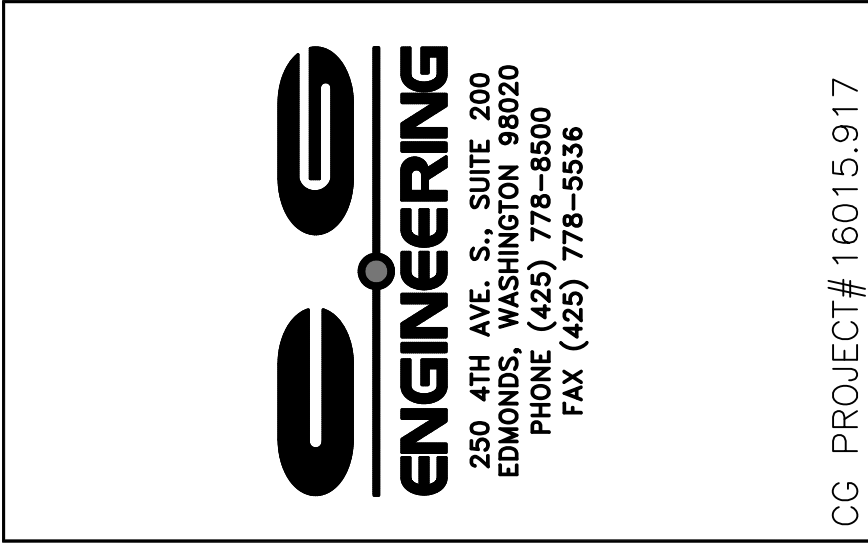

PROJECT MANAGER	M/IM	
PREPARED BY	ZOS	
APPROVED BY	JAC	
REV	DATE	DESCRIPTION
△	04/14/17	PERMIT RESUBMITTAL
△	02/24/17	PERMIT RESUBMITTAL
△	02/17/17	PERMIT SUBMITTAL

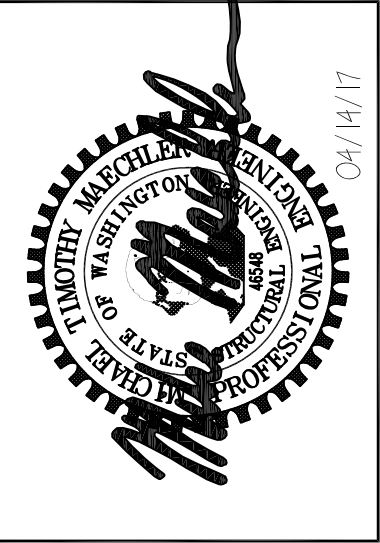

CITY APPROVAL

SHEET NAME
BUILDING AND FUEL TANK FOUNDATIONS STRUCTURAL NOTES

SHEET NUMBER
F1.1

ANCHOR PLATES ALONG THE SHORT SIDES OF THE SHELTER SHALL BE FIELD WELDED PER NOTE IN DETAIL 5

ANCHOR PLATE PER DETAIL 5, TYP
(12) LOCATIONS. LOCATE ANCHOR PLATES AT SHELTER LIFT DEVICE LOCATIONS PER SHELTER MFR

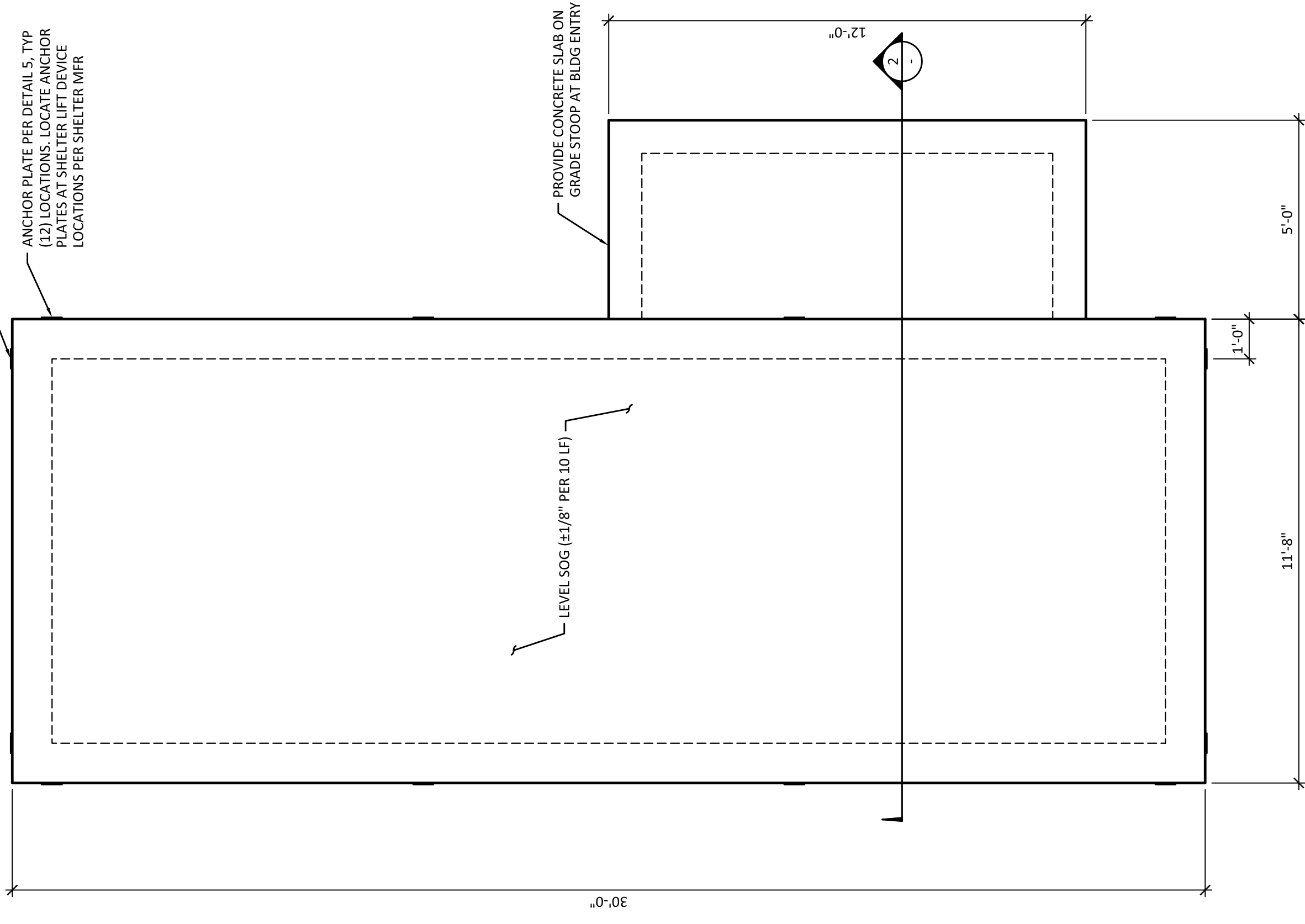

1 SHELTER FOUNDATION PLAN
SCALE: 3/8" = 1'-0"

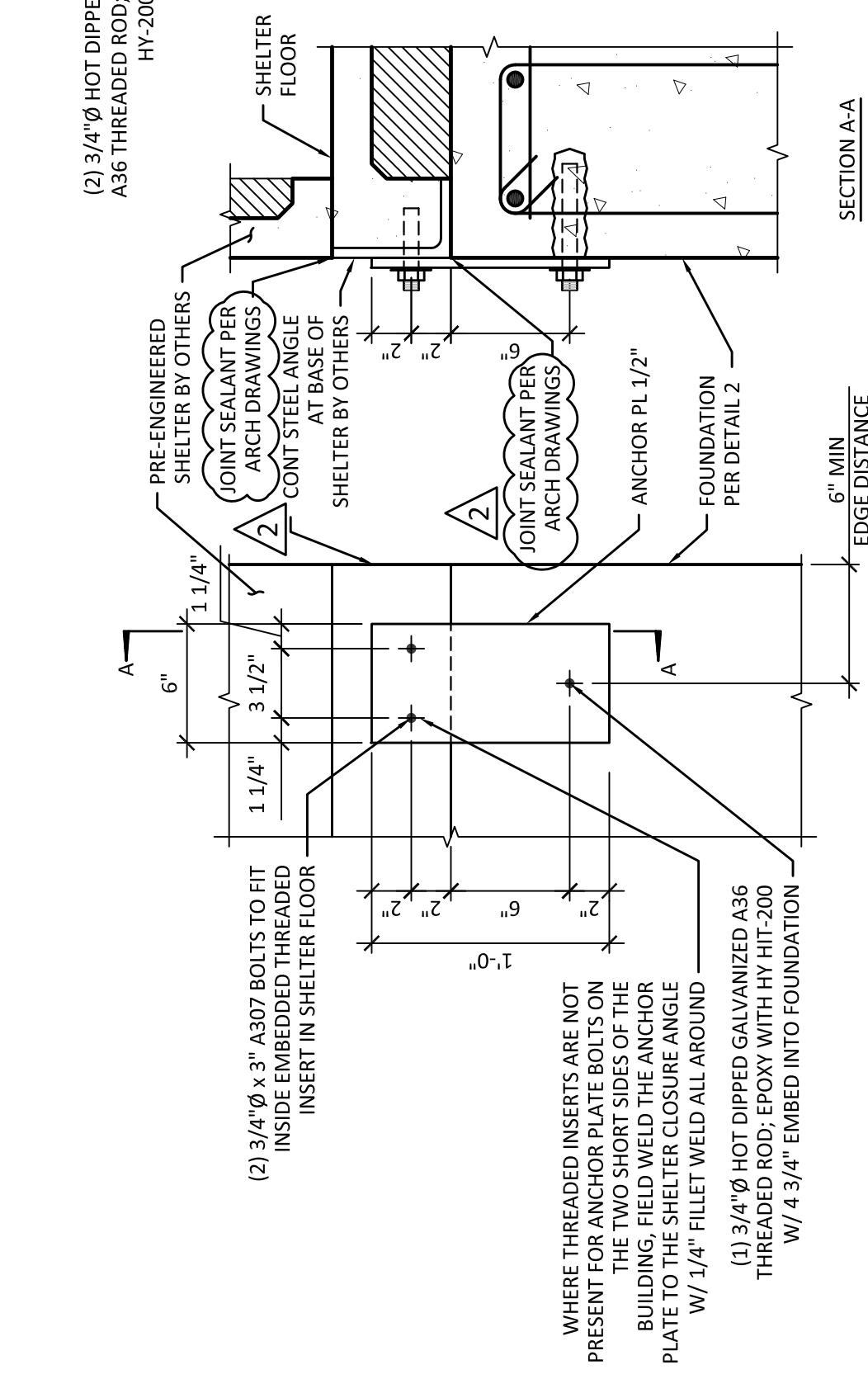

5 SHELTER ANCHORAGE DETAIL
SCALE: 1 1/2" = 1'-0"

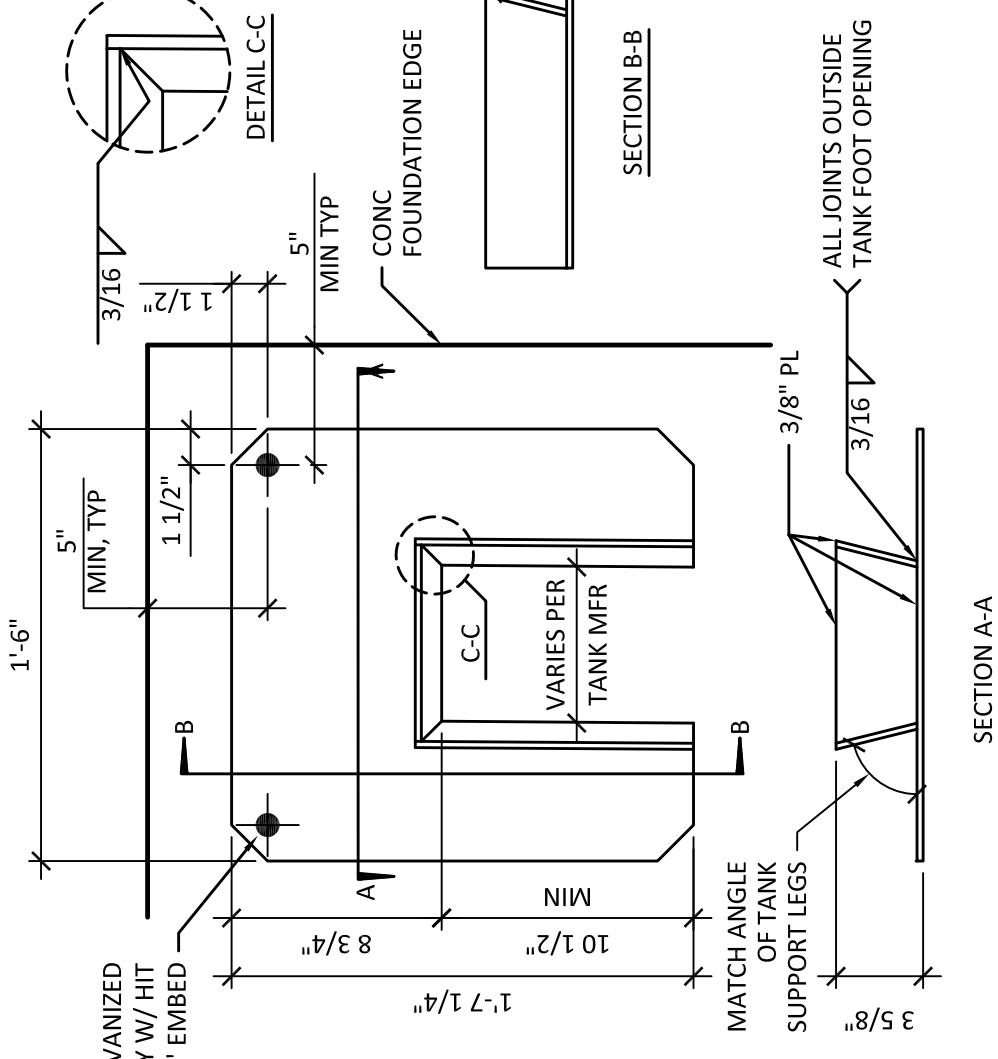

6 FUEL TANK LATERAL RESTRAINTS
SCALE: 1 1/2" = 1'-0"

7 ICE BRIDGE PIER FOUNDATIONS
SCALE: 1/2" = 1'-0"

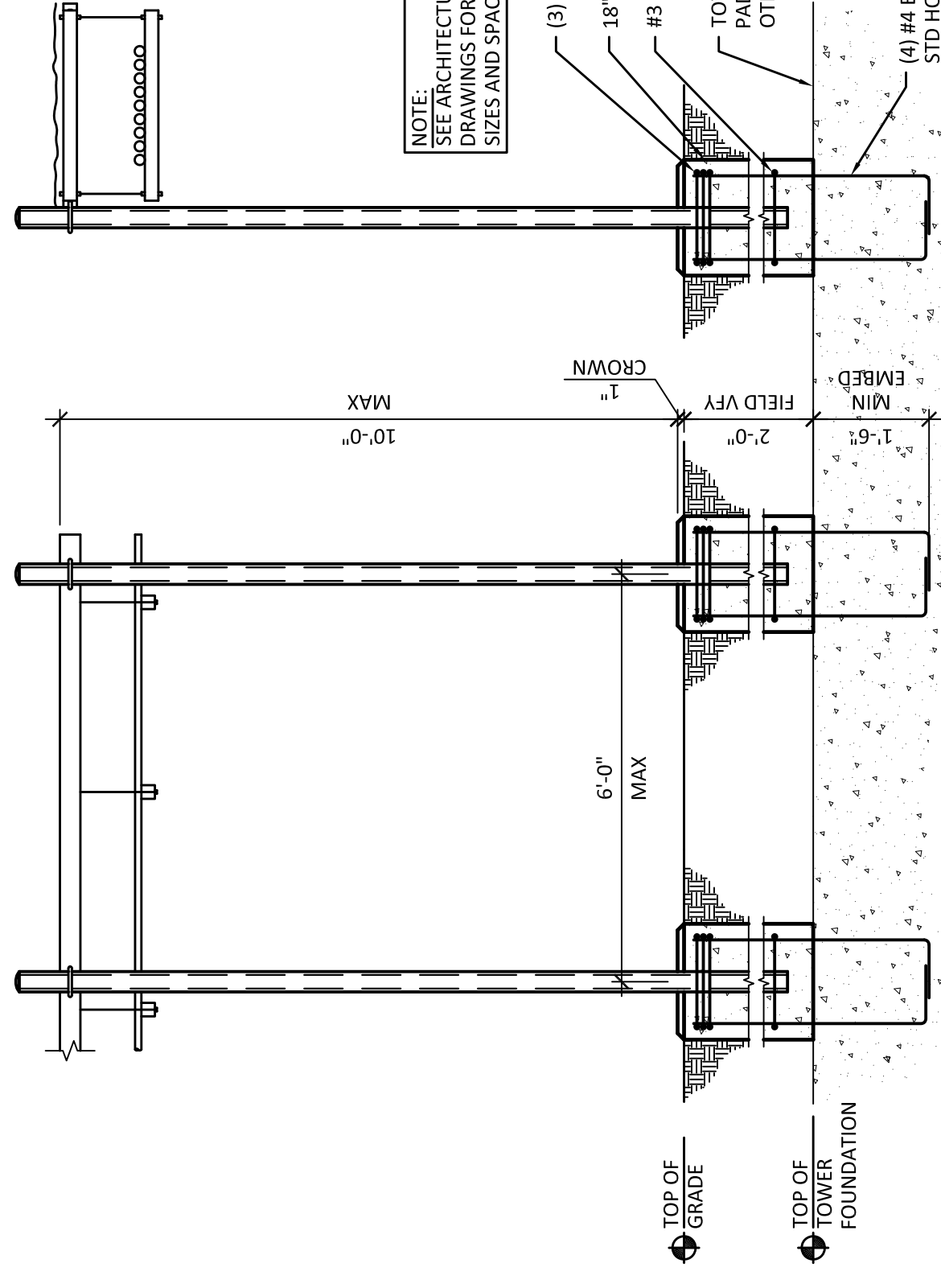

4 DIESEL TANK SECTION
SCALE: 1/2" = 1'-0"

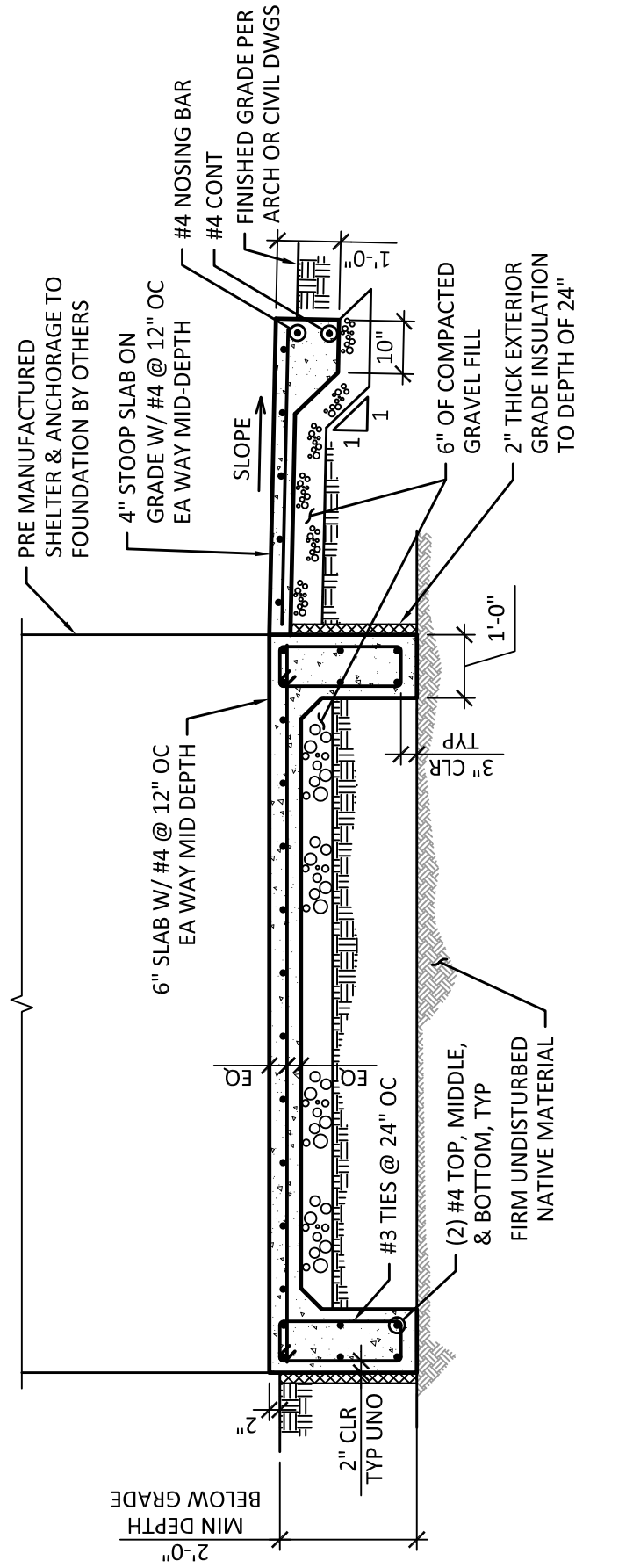

2 SHELTER FOUNDATION SECTION
SCALE: 3/8" = 1'-0"

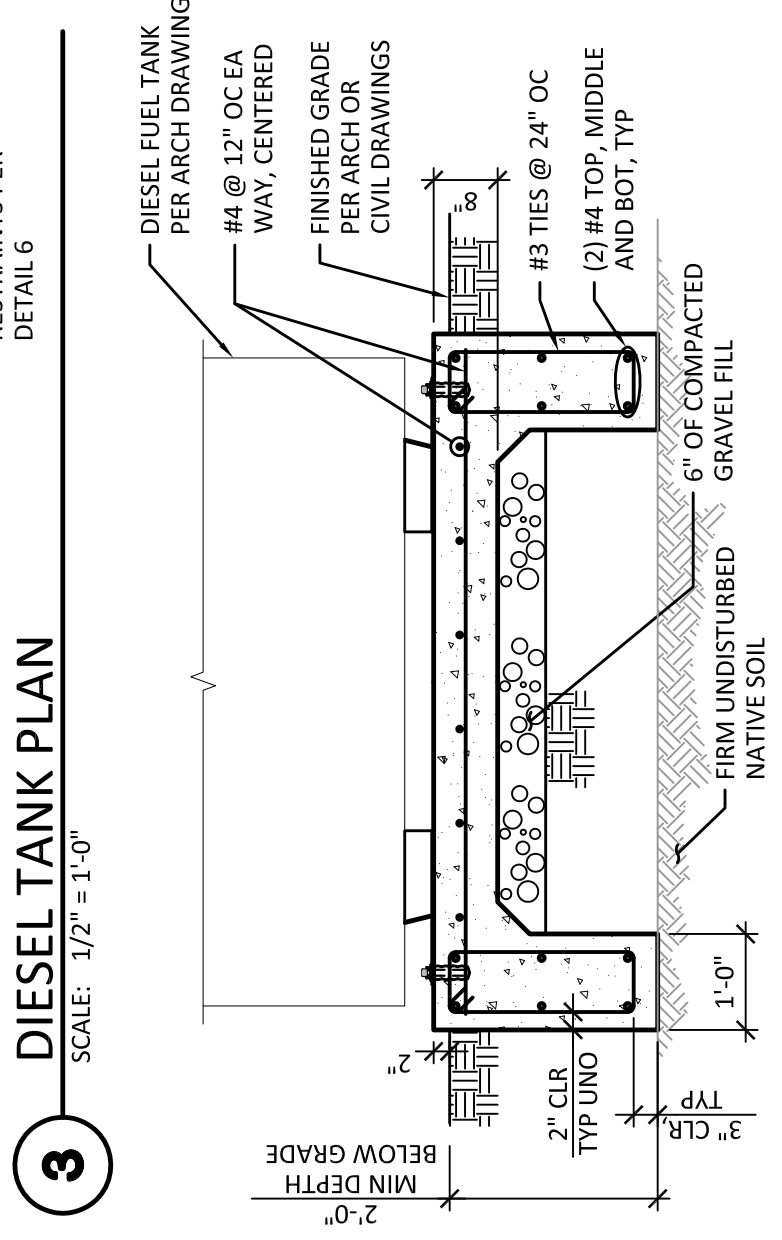

3 DIESEL TANK SECTION
SCALE: 1/2" = 1'-0"

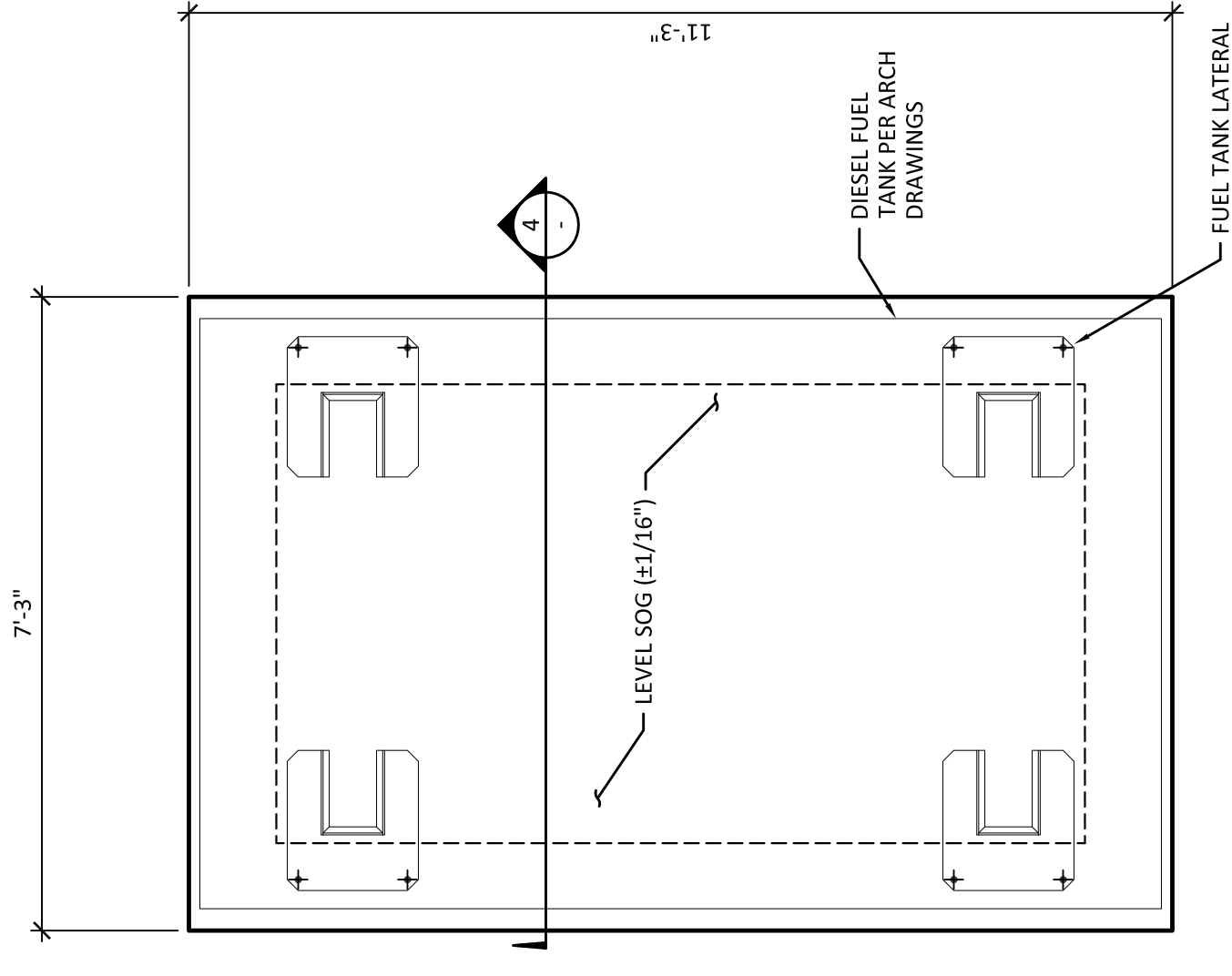

3 DIESEL TANK PLAN
SCALE: 1/2" = 1'-0"



SWAN
(NEW BUILD)
39025 NE NORTH FORK RD.
DUWALL WA 98019

ENGINEERING
250 4TH AVE. S. SUITE 200
EDMONDS, WASHINGTON 98020
PHONE (425) 778-8500
FAX (425) 778-5536

CC. PROJECT # 16015.917
PROJECT MANAGER M/TM
PREPARED BY ZOS
APPROVED BY JAC

REV	DATE	DESCRIPTION
Δ	04/14/17	PERMIT RESUBMITTAL
Δ	02/24/17	PERMIT RESUBMITTAL
Δ	02/17/17	PERMIT SUBMITTAL

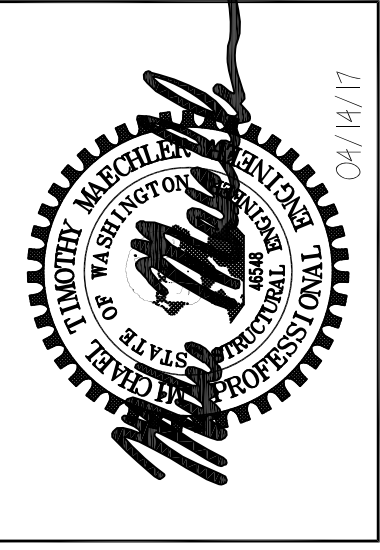

CITY APPROVAL

SHEET NAME
BUILDING AND TANK
FOUNDATION PLANS
AND DETAILS

SHEET NUMBER
F2.1

DESIGN CRITERIA :

BASIC WIND SPEED: 85 mph

ICE WIND SPEED: 30 mph

ICE THICKNESS: 0.5 " Radial

STRUCTURE CLASS III

EXPOSURE CATEGORY C

TOPOGRAPHIC CATEGORY 1

SEISMIC: SITE CLASS C, $S_s = 1.124$, $S_1 = 0.426$

ANTENNAS

SEE SHEET 6 FOR ANTENNA LIST

MATERIALS & CODES

STRUCTURAL STEEL: ASTM A36, A572 & A53 GR.B (50 ksi minimum)

ERECTION BOLTS: ASTM A325X & SAE GR.5 ANCHOR BOLTS: ASTM F1554 GR.55

STEEL: AISC LRFD

CONCRETE: ACI 318

INDUSTRY: ANSII/TIA 222-G

BAY	TOWER	ELEV.	DEAD LOAD	WIND LOAD	BAY
DV05	235	0.32	0.63	0.90	
DV10	225	0.69	1.09	1.42	
DV20	215	0.72	1.36	1.42	
DV20	210	0.62	1.36	1.42	
DV20	205	0.72	1.36	1.42	
DV20	200	0.65	1.35	1.42	
DV20	195	0.78	1.34	1.42	
DV20	190	0.68	1.33	1.42	
DV20	185	0.78	1.33	1.42	
DV20	180	0.70	1.31	1.42	
ET	175	0.80	1.36	1.00	
ET	170	0.77	1.43	0.99	
ET	165	0.77	1.44	0.93	
ET	160	1.14	1.99	0.85	
FT	151	1.88	2.79	0.76	
FT	140	1.96	2.80	0.61	
GT	131	2.40	2.77	0.54	
GT	120	2.16	2.81	0.20	
HT	110	2.39	2.85	0.01	
HT	100	2.14	2.83	0.01	
IT	90	2.54	2.81	0.01	
IT	80	2.17	2.77	0.01	
JT	70	2.61	2.71	0.01	
JT	60	2.31	2.70	0.01	
KT	50	3.06	2.68	0.01	
KT	40	2.47	2.59	0.01	
LT	30	3.15	2.44	0.01	
LT	20	2.57	2.29	0.01	
MT	10	3.40	2.20	0.01	
MT	0	1.38	1.23	0.01	

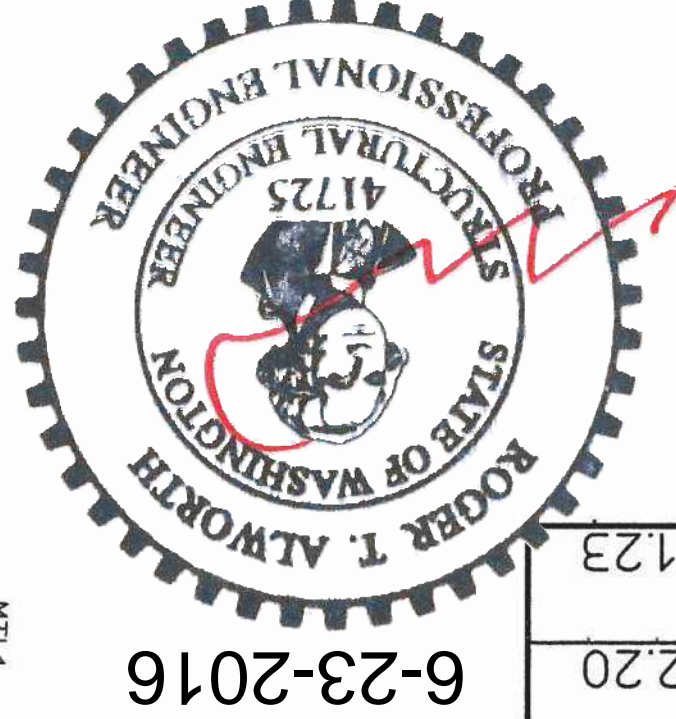
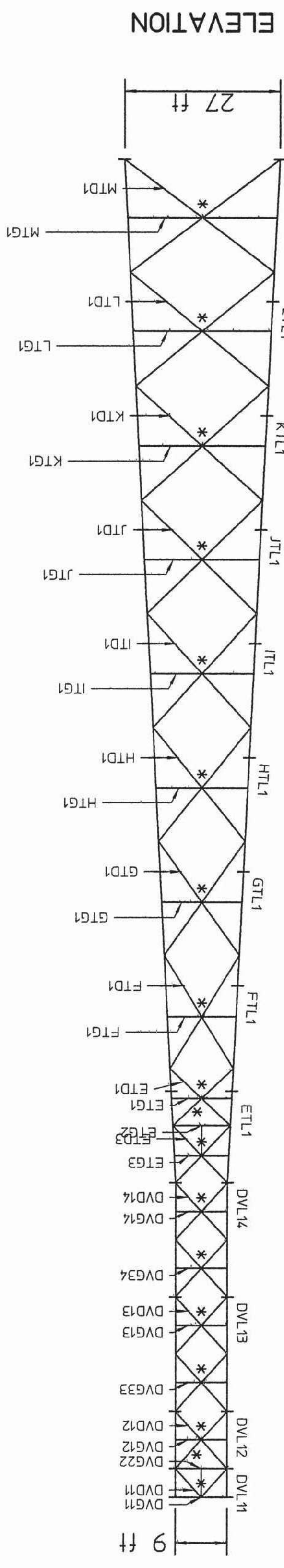

VECTOR ENGINEERS
 9138 S. STATE STREET, SUITE 101
 SANDY, UT 84070
 P: (801) 990-1775 F: (801) 990-1776
 VECTOR PROJECT: U1316-126-161
 ROGER T. ALWORTH, S.E.: 41725
 WA FIRM LICENSE: 2202

TOWER MODEL: 108-L855-235

STRESS ANALYSIS
 ODELIA PACIFIC/KING COUNTY
 SITE: SWAN, WA

valmont MICROFLECT
 1-877-467-4763 Plymouth, IN
 1-800-547-2151 Salem, OR

BY	JG
CK	MF
DATE	16 JUN 16
S.O.	333171-1

SHEET 1 OF 6
 DWG. NO. B-143904

ANT. DEAD LOAD	ANT. WIND LOAD	MAXIMUM DEAD OR TWIST OR SWAY
2.08	6.07	1.42
2.43	4.25	1.42
1.05	2.87	1.42
1.11	4.19	1.43
0.40	2.81	1.42
0.00	1.50	1.37
0.27	1.77	1.08
0.05	0.31	1.00
0.02	0.04	0.99
0.00	0.01	0.93
0.07	0.18	0.85
0.19	0.50	0.76
0.01	0.01	0.61
0.14	0.22	0.54
0.01	0.02	0.20
0.01	0.02	0.15

NOTES:

- 1) Bay wind loads and dead loads include effects of tower members, access ladder, W/G ladders, and transmission lines.
- 2) Worst case antenna wind shear has been applied in multiple wind directions to obtain maximum tower member stresses.
- 3) An '*' indicates that girts are internally braced at this level.
- 4) Maximum twist/sway at 60 MPH wind loading is 0.39° > 0.47° allowable for a 6' diameter antenna (Worst case elevation) operating at an assumed frequency of 11 GHz.
- 5) Max Stress Ratio <= 85%.

REVISIONS

REV	DESCRIPTION	DATE	BY/CK

MISCELLANEOUS EQUIPMENT SCHEDULE

SYMBOL	ITEM DESCRIPTION	SPECIFIED MFR & MODEL NO.	AREA SERVED	EQUIPMENT CAPACITY	ELECTRICAL AMPS	VOLTS/PH	REMARKS
LDP-1	TANK GAUGE AND LEAK DETECTION PANEL	FUEL SENTRY TG-EL-D4A	TANK, DAY TANK	6 INPUT	4-2	120/1	PROVIDE NEMA 3 ENCLOSURE

PIPING MATERIAL SCHEDULE

PIPING	LOCATION	MATERIAL	JOINT
DIESEL FUEL SUPPLY/RETURN	ALL	PVED DOUBLE WALLED FLEXIBLE END FITTINGS	STAINLESS STEEL END FITTINGS
DIESEL FUEL VENT	ABOVE GROUND	SCHEDULE 40 STEEL	THREADED
CONDUIT FOR FUEL PIPE	ALL	SCHEDULE 40 PVC	GLUED

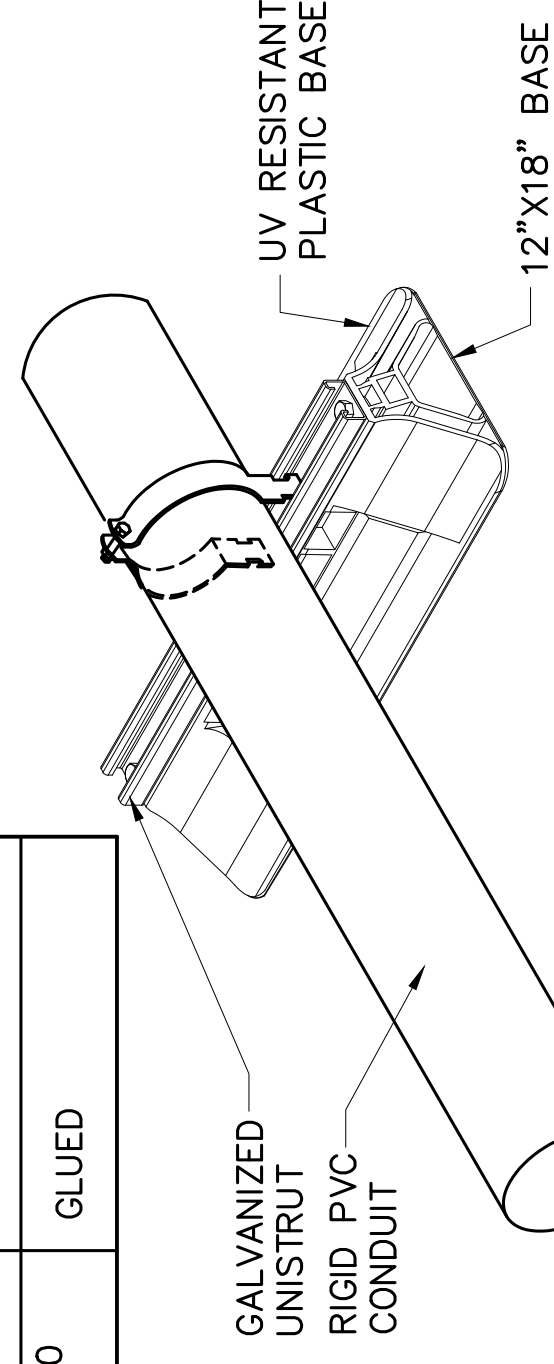

PIPE SUPPORT

NOT TO SCALE

1 M1.0

CONNECT TO DRY CONTACTOR IN DAY TANK CONTROLS. LDP-1 TO ALARM ON DAY TANK LEAK DETECTION.

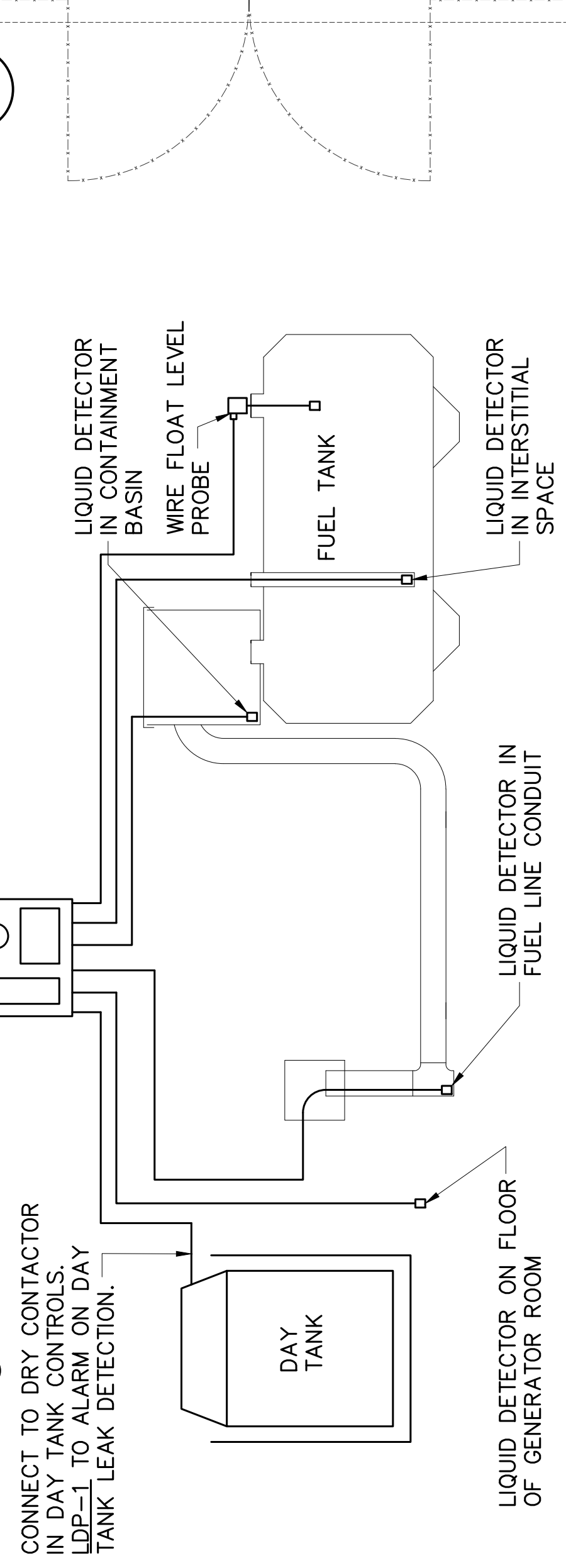

NOTE: PROVIDE WIRE AND CONDUIT FROM PANEL TO EACH LEAK DETECTION DEVICE.

LEAK DETECTION SYSTEM DIAGRAM

NOT TO SCALE

3 M1.0

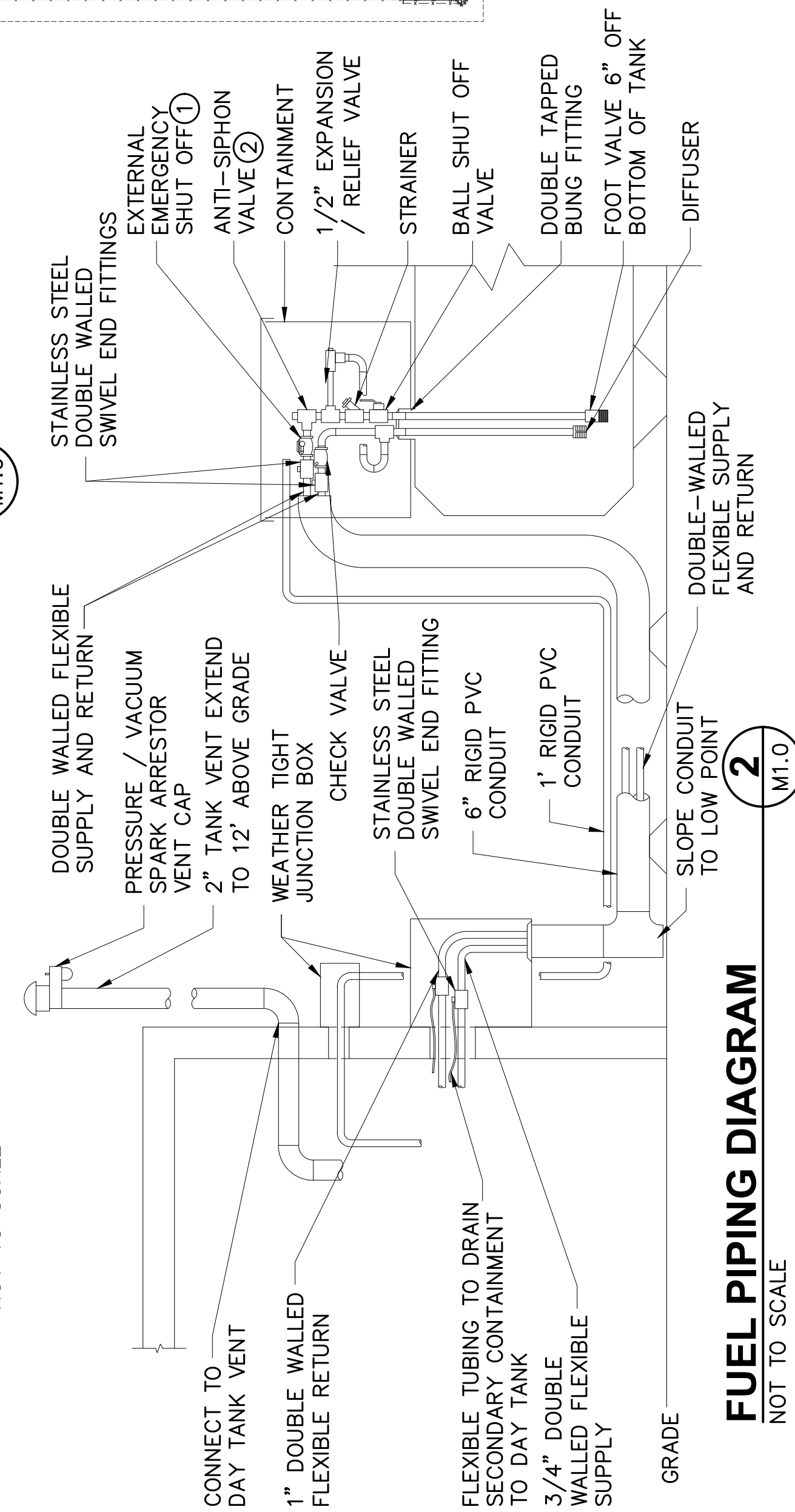

FUEL PIPING DIAGRAM

NOT TO SCALE

2 M1.0

KEYED NOTES:

- 1 FULL LINE SIZE FUSEABLE LINK SHUT-OFF VALVE.
- 2 COMPATIBLE IN A SUCTION SYSTEM.
- 3 VERIFY DAY TANK'S SUPPLY AND RETURN PUMPS ARE OPERATING CORRECTLY TO MOVE FUEL WITHOUT SPILL OR OVERFLOW.
- 4 COORDINATE CONNECTION OF ALARM OUTPUTS TO KING COUNTY COMMUNICATIONS SYSTEM.

DRAWING NOTES:

1. FUEL PIPING INSTALLATION SHALL CONFORM TO 2015 NFPA 30.
2. SEAL ALL CONDUIT AND CONTAINMENTS TO BE WATER TIGHT.
3. CONTRACTOR SHALL LAY OUT CONTAINMENT CONDUITS AND PIPING SO THAT ANY POINT OF LEAKAGE IS CAUGHT BY SECONDARY CONTAINMENT AND ALARMS WITH THE LEAK DETECTION SYSTEM.
4. COORDINATE CONNECTION OF LEAK DETECTION SYSTEM TO REMOTE MONITORING.
5. PRESSURE TEST PRIMARY AND SECONDARY CONTAINMENT PIPING PER UFC REQUIREMENTS.

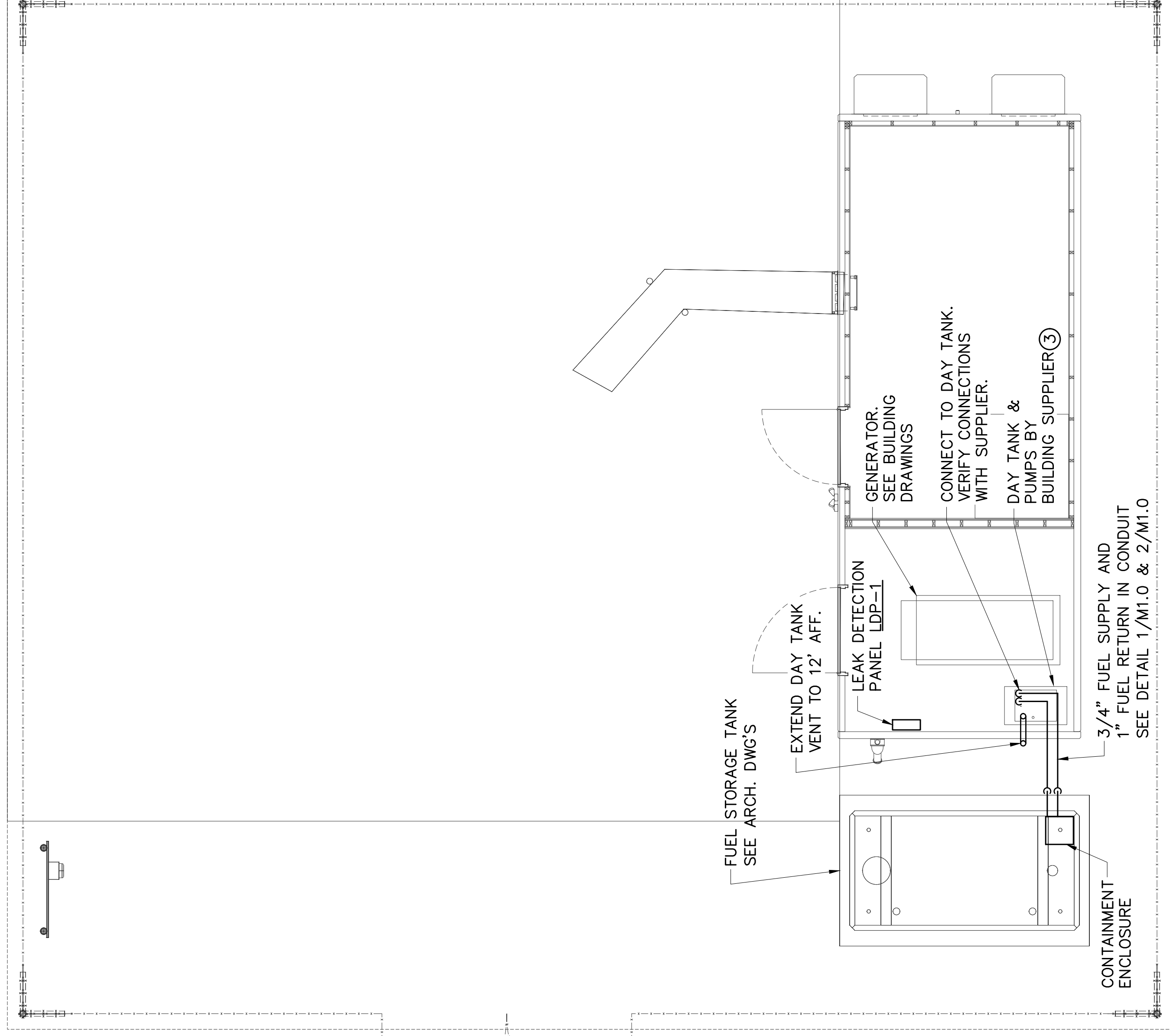

FUEL SYSTEM PIPING PLAN

SCALE: 1/4" = 1'-0" (22x34), 1/8" = 1'-0" (11x17)

1



SWAN
(NEW BUILD)
39025 NE NORTH FORK RD.
DUVALL, WA 98019

DEBELIA PACIFIC CORPORATION
5506 6TH AVE S, SUITE 202
SEATTLE, WA 98108
PHONE: (206) 460-3826
WWW.ODELA.COM

CAMP+ ASSOCIATES
19401 40TH AVE W, SUITE 304
LYNNWOOD, WA 98036
PHONE: (425) 740-8392
FAX: (425) 252-2860
WWW.CAMPASSOC.COM

PROJECT MANAGER:
PREPARED BY: SJC

APPROVED BY: TAV

DATE	REVISIONS
11/02/16	PERMIT REVISIONS
09/30/16	FINAL DRAWING
05/06/16	ISSUED FOR PRELIM. REVIEW

PLAN REVIEWERS SIGNATURE

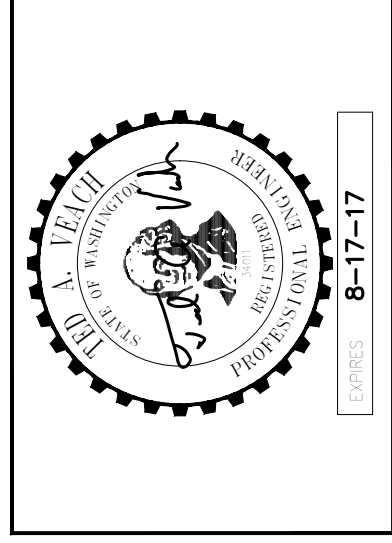

SHEET NAME
FUEL SYSTEM PIPING PLAN

SHEET NUMBER
M1.0



12202 Pacific Ave, Suite B Tacoma, WA 98444
Ph: 252-274-5701 Prof: 1532



SWAN
 (NEW BUILD)
 39025 NE NORTH FORK RD.
 DUVALL, WA 98019

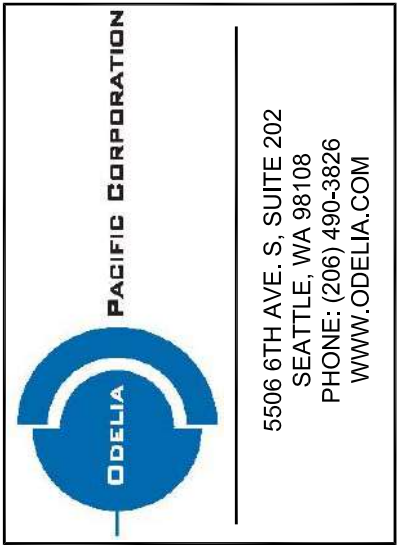

PROJECT MANAGER: EJC

PREPARED BY: AIO/EAT

APPROVED BY: PN

- ▲ 07/31/17 UPDATED SURVEY
- ▲ 07/31/17 DPER COMMENTS
- ▲ 06/27/17 ELECTRICAL TIE-IN W/ SCL
- ▲ 06/15/17 ISSUED FOR PERMIT

PLAN REVIEWERS SIGNATURE



SHEET NAME
 ELECTRICAL
 SITE PLAN

SHEET NUMBER
E-1

- KEY NOTES:**
- 1 EXISTING UTILITY POLE WITH POLE MOUNTED TRANSFORMER PROVIDED AND INSTALLED BY SEATTLE CITY LIGHT.
 - 2 CONTRACTOR SHALL TERMINATE NEW RACEWAY 40'-0" ABOVE FINISH GRADE AT NEW WEATHER HEAD. CONDUIT AND CONDUCTORS SHALL BE INSTALLED ON FACE OF POLE (NORTH SIDE). COORDINATE INSTALLATION WITH SEATTLE CITY LIGHT.
 - 3 NEW 120/240V 1/0 3W UNDERGROUND SERVICE MINIMUM 36" BELOW FINISH GRADE.
 - 4 NEW UTILITY METER WITH MAIN BREAKER MOUNTED TO NEW UNISTRUT FRAME.
 - 5 CONTRACTOR SHALL TERMINATE AT AUTOMATIC TRANSFER SWITCH PROVIDED WITH NEW PRE-MANUFACTURED EQUIPMENT SHELTER.
 - 6 CONTRACTOR SHALL PROVIDE ALARM CONNECTIONS TO FUEL TANK AND LEAK DETECTION ALARM CONDUCTORS. PROVIDE (12 #16) 3/4"C TO LEAK DETECTION CONTROL PANEL. VERIFY EXACT QUANTITY OF CONDUCTORS WITH LEAK DETECTION PANEL PROVIDED.
 - 7 CONTRACTOR TO PROVIDE 120V CONNECTION TO LEAK DETECTION PANEL FROM PANELBOARD PROVIDED WITH EQUIPMENT SHELTER.

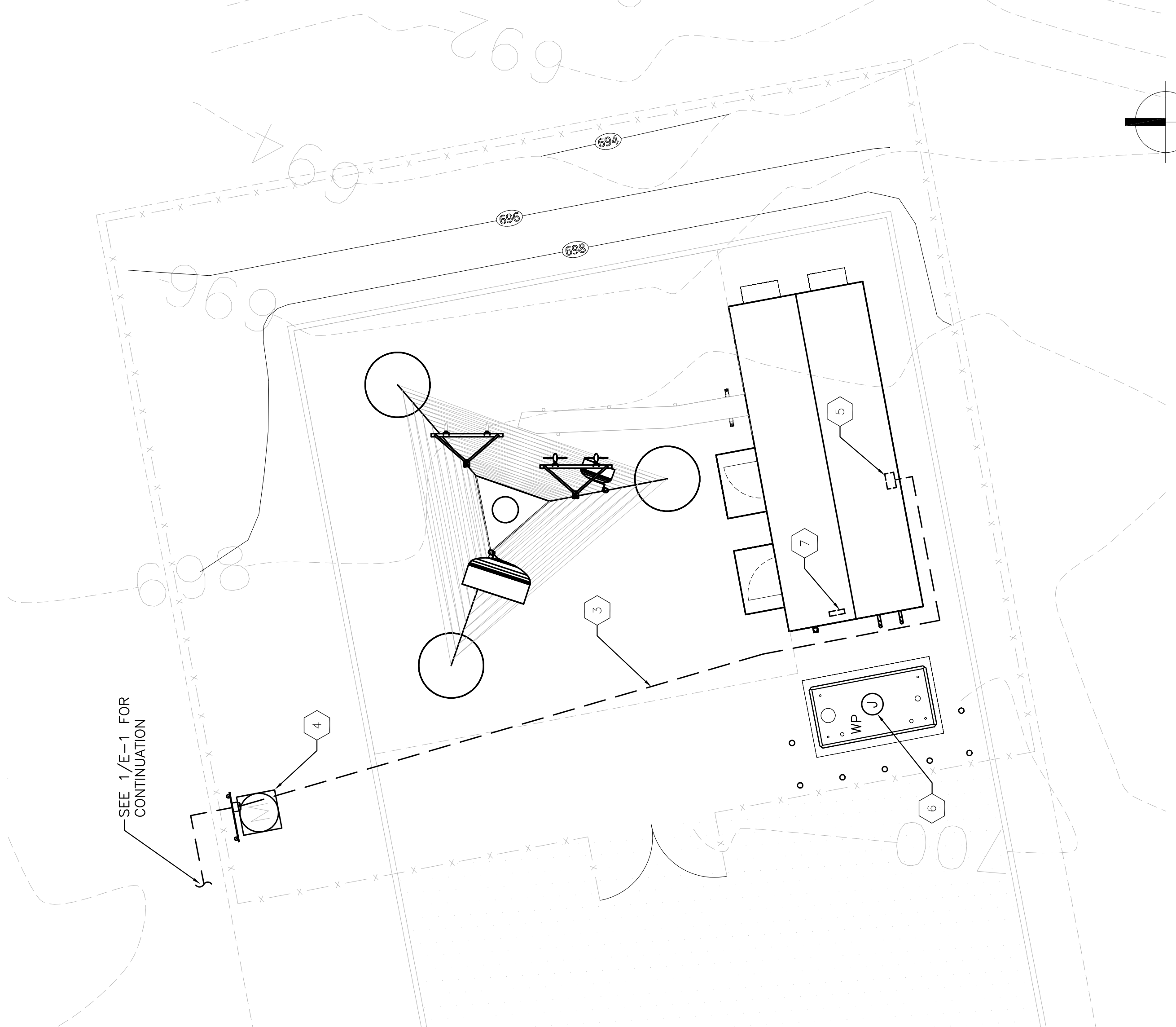

2 PARTIAL ELECTRICAL SITE PLAN
 SCALE: 1/8" = 1'-0" (22x34), 1/16" = 1'-0" (11x17)

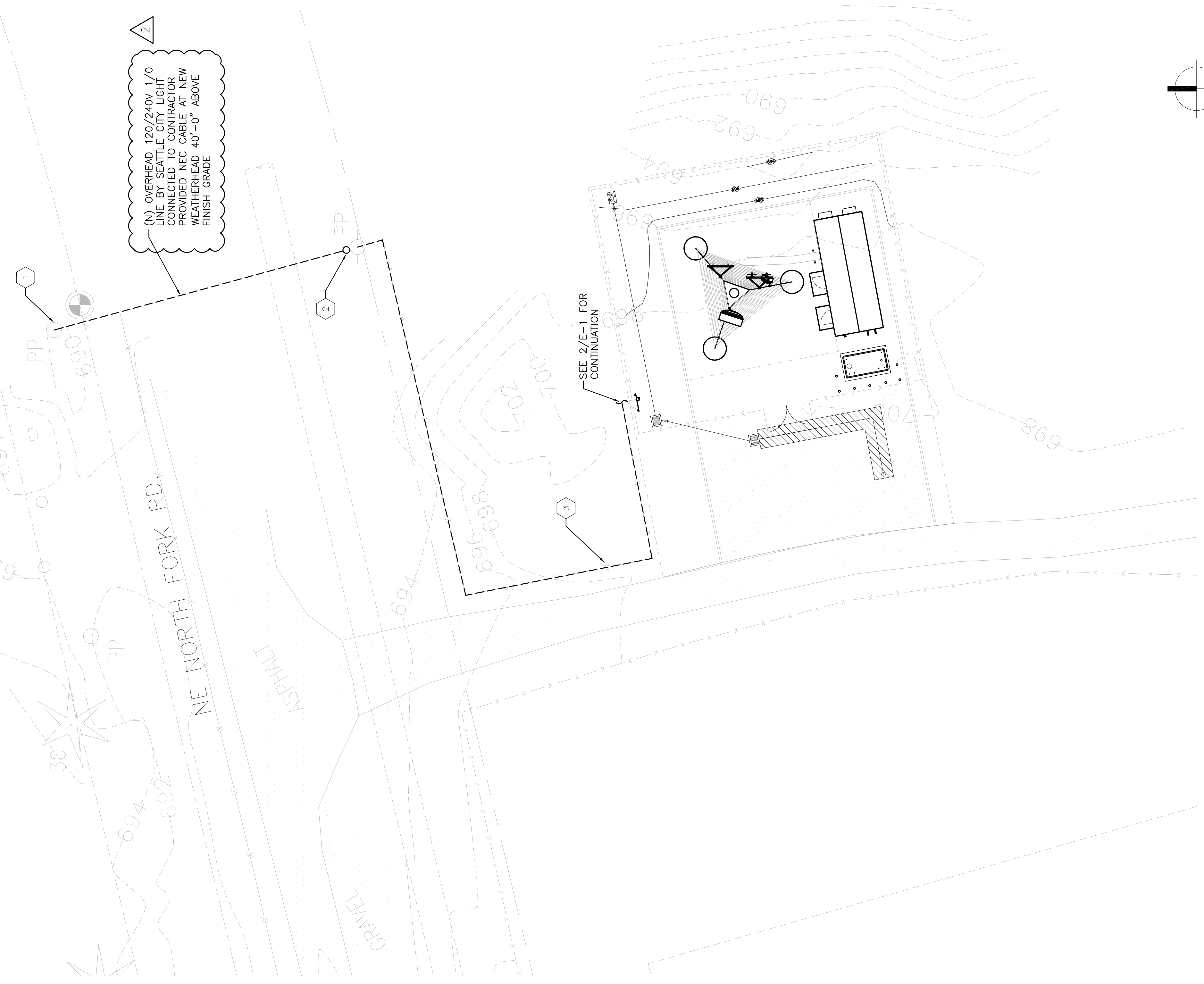

1 ELECTRICAL SITE PLAN
 SCALE: 1/16" = 1'-0" (22x34), 1/32" = 1'-0" (11x17)

PP1												
225 A. BUS 200 A. MAIN CIRCUIT BREAKER												
240 / 120 VOLT, 1 PHASE, 3 WIRE												
10000 AMPERE PANEL SHORT CIRCUIT RATING												
PANEL TYPE: PROVIDED WITH EQUIPMENT SHELTER												
PANEL MOUNTING: SURFACE												
NOTE: PROVIDED WITH EQUIPMENT SHELTER												
DESCRIPTION	TOTAL BREAKER (VA)	A	P	CCT	PH	CCT	PH	CCT	BREAKER A	P	TOTAL (VA)	DESCRIPTION
HVAC #1	2800	50	2	1	A	2	A	2	50	2	2800	HVAC #2
PANEL PP2	14940	125	2	3	B	4	B	4	60	2	14940	REUNDANT UNIT
EXTERIOR LTC	14580	20	1	7	B	8	B	8	20	1	14580	SURGE ARRESTOR
EQ ROOM LTC	198	20	1	9	A	10	A	10	20	1	198	EXT GFI RECEP
FIRE SUPPRESSION	1011	20	1	11	B	12	B	12	20	1	1011	900 EQUIP RM RECEP
	126	20	1	13	A	14	A	14	20	1	126	FUEL PUMP
		20	1	15	B	16	B	16	20	1	500	LEAK CONTROL PANEL
		17	A	17	A	18	A	18	20	1		
		19	B	19	B	20	B	20	20	1		
		21	A	21	A	22	A	22	20	1		
		23	B	23	B	24	B	24	20	1		
		25	A	25	A	26	A	26	20	1		
		27	B	27	B	28	B	28	20	1		
		29	A	29	A	30	A	30	20	1		
		31	B	31	B	32	B	32	20	1		
		33	A	33	A	34	A	34	20	1		
		35	B	35	B	36	B	36	20	1		
		37	A	37	A	38	A	38	20	1		
		39	B	39	B	40	B	40	20	1		
		41	A	41	A	42	A	42	20	1		
		42	B	42	B	43	B	43	20	1		
		43	A	43	A	44	A	44	20	1		
		44	B	44	B	45	B	45	20	1		
		45	A	45	A	46	A	46	20	1		
		46	B	46	B	47	B	47	20	1		
		47	A	47	A	48	A	48	20	1		
		48	B	48	B	49	B	49	20	1		
		49	A	49	A	50	A	50	20	1		
		50	B	50	B	51	B	51	20	1		
		51	A	51	A	52	A	52	20	1		
		52	B	52	B	53	B	53	20	1		
		53	A	53	A	54	A	54	20	1		
		54	B	54	B	55	B	55	20	1		
		55	A	55	A	56	A	56	20	1		
		56	B	56	B	57	B	57	20	1		
		57	A	57	A	58	A	58	20	1		
		58	B	58	B	59	B	59	20	1		
		59	A	59	A	60	A	60	20	1		
		60	B	60	B	61	B	61	20	1		
		61	A	61	A	62	A	62	20	1		
		62	B	62	B	63	B	63	20	1		
		63	A	63	A	64	A	64	20	1		
		64	B	64	B	65	B	65	20	1		
		65	A	65	A	66	A	66	20	1		
		66	B	66	B	67	B	67	20	1		
		67	A	67	A	68	A	68	20	1		
		68	B	68	B	69	B	69	20	1		
		69	A	69	A	70	A	70	20	1		
		70	B	70	B	71	B	71	20	1		
		71	A	71	A	72	A	72	20	1		
		72	B	72	B	73	B	73	20	1		
		73	A	73	A	74	A	74	20	1		
		74	B	74	B	75	B	75	20	1		
		75	A	75	A	76	A	76	20	1		
		76	B	76	B	77	B	77	20	1		
		77	A	77	A	78	A	78	20	1		
		78	B	78	B	79	B	79	20	1		
		79	A	79	A	80	A	80	20	1		
		80	B	80	B	81	B	81	20	1		
		81	A	81	A	82	A	82	20	1		
		82	B	82	B	83	B	83	20	1		
		83	A	83	A	84	A	84	20	1		
		84	B	84	B	85	B	85	20	1		
		85	A	85	A	86	A	86	20	1		
		86	B	86	B	87	B	87	20	1		
		87	A	87	A	88	A	88	20	1		
		88	B	88	B	89	B	89	20	1		
		89	A	89	A	90	A	90	20	1		
		90	B	90	B	91	B	91	20	1		
		91	A	91	A	92	A	92	20	1		
		92	B	92	B	93	B	93	20	1		
		93	A	93	A	94	A	94	20	1		
		94	B	94	B	95	B	95	20	1		
		95	A	95	A	96	A	96	20	1		
		96	B	96	B	97	B	97	20	1		
		97	A	97	A	98	A	98	20	1		
		98	B	98	B	99	B	99	20	1		
		99	A	99	A	100	A	100	20	1		
		100	B	100	B	101	B	101	20	1		
		101	A	101	A	102	A	102	20	1		
		102	B	102	B	103	B	103	20	1		
		103	A	103	A	104	A	104	20	1		
		104	B	104	B	105	B	105	20	1		
		105	A	105	A	106	A	106	20	1		
		106	B	106	B	107	B	107	20	1		
		107	A	107	A	108	A	108	20	1		
		108	B	108	B	109	B	109	20	1		
		109	A	109	A	110	A	110	20	1		
		110	B	110	B	111	B	111	20	1		
		111	A	111	A	112	A	112	20	1		
		112	B	112	B	113	B	113	20	1		
		113	A	113	A	114	A	114	20	1		
		114	B	114	B	115	B	115	20	1		
		115	A	115	A	116	A	116	20	1		
		116	B	116	B	117	B	117	20	1		
		117	A	117	A	118	A	118	20	1		
		118	B	118	B	119	B	119	20	1		
		119	A	119	A	120	A	120	20	1		
		120	B	120	B	121	B	121	20	1		
		121	A	121	A	122	A	122	20	1		
		122	B	122	B	123	B	123	20	1		
		123	A	123	A	124	A	124	20	1		
		124	B	124	B	125	B	125	20	1		
		125	A	125	A	126	A	126	20	1		
		126	B	126	B	127	B	127	20	1		
		127	A	127	A	128	A	128	20	1		
		128	B	128	B	129	B	129	20	1		
		129	A	129	A	130	A	130	20	1		
		130	B	130	B	131	B	131	20	1		
		131	A	131	A	132	A	132	20	1		
		132	B	132	B	133	B	133	20	1		
		133	A	133	A	134	A	134	20	1		
		134	B	134	B	135	B	135	20	1		
		135	A	135	A	136	A	136	20	1		
		136	B	136	B	137	B	137	20	1		
		137	A	137	A	138	A	138	20	1		
		138	B	138	B	139	B	139	20	1		
		139	A	139	A	140	A	140	20	1		
		140	B	140	B	141	B	141	20	1		
		141	A	141	A	142	A	142	20	1		
		142	B	142	B	143	B	143	20	1		
		143	A	143	A	144	A	144	20	1		
		144	B	144	B	145	B	145	20	1		
		145	A	145	A	146	A	146	20	1		
		146	B	146	B	147	B	147	20	1		
		147	A	147	A	148	A	148	20	1		
		148	B	148	B	149	B	149	20	1		
		149	A									



SWAN
(NEW BUILD)
39025 NE NORTH FORK RD.
DUVALL, WA 98019

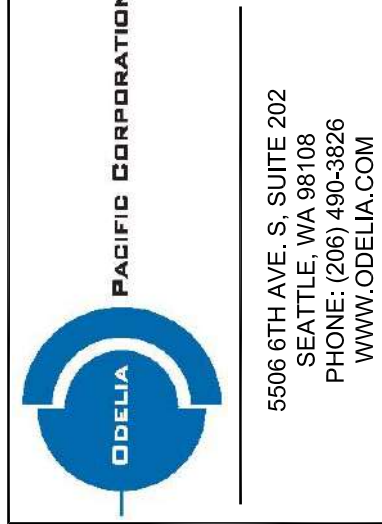

PROJECT MANAGER: EJC

PREPARED BY: AJO/EAT

APPROVED BY: PN

07/31/17	UPDATED SURVEY
07/31/17	DPER COMMENTS
06/27/17	ELECTRICAL TIE-IN W/ SCL
06/15/17	ISSUED FOR PERMIT

PLAN REVIEWERS SIGNATURE



SHEET NAME
GROUNDING PLANS & NOTES

SHEET NUMBER
E-3.0

GENERAL NOTES:

- ALL CADWELD CONNECTIONS ON GALVANIZED SURFACES SHALL BE CLEANED THOROUGHLY AND COVERED WITH TWO (2) COATS OF SHERWIN WILLIAMS GALVANITE B350W3 OR EQUAL.
- ALL ELECTRICAL CADWELD AND MECHANICAL GROUND CONNECTIONS WILL HAVE NON-OXIDATION COMPOUND APPLIED TO CONNECTION.
- ANY METAL OBJECTS WITHIN 6 FEET OF THE EXTERNAL GROUND RING SHALL BE GROUNDED.
- ALL GROUNDING MATERIALS AND CADWELD MOLDS, SHOTS, ETC. SHALL BE FURNISHED AND INSTALLED BY CONTRACTOR UNLESS OTHERWISE NOTED.
- THE ELECTRICAL CONTRACTOR SHALL FOLLOW GROUNDING SYSTEM INSTALLED AND TESTING PROCEDURES AS DESCRIBED IN THE GENERAL ELECTRICAL PROVISIONS.
- CONNECTIONS TO THE GROUND BUS SHALL NOT BE DOUBLED UP OR STACKED. BACK TO BACK CONNECTIONS ON OPPOSITE SIDES OF THE GROUND BUS ARE PERMITTED.
- USE OF 90° BENDS IN THE PROTECTION GROUNDING CONDUCTORS SHALL BE AVOIDED WHEN 45° BENDS CAN BE ADEQUATELY SUPPORTED.
- OBSERVE NEC AND LOCAL UTILITY REQUIREMENTS FOR ELECTRICAL SERVICE GROUNDING.
- MAXIMUM RESISTANCE OF THE COMPLETED GROUND SYSTEM SHALL NOT EXCEED 5 OHMS.
- SITE TO COMPLY WITH R56 STANDARDS FOR GROUNDING.

ITEM	LEGEND	DESCRIPTION
⊗		3/4" DIAMETER x 10'-0" LONG COPPER CLAD GROUND ROD, MINIMUM 30" BELOW GRADE, AT MINIMUM 10'-0" O.C. (HARGER #5810).
⊠		CADWELD INSPECTION WELL.
—		#2 AWG TINNED SOLID BARE COPPER WIRE, MINIMUM 30" BELOW GRADE, OR 6" BELOW LOCAL FROST LINE.
■		CADWELD/EXOTHERMIC WELD CONNECTION.
●		MECHANICAL CONNECTION.

KEYED NOTES:

- NEW 235' HIGH SELF-SUPPORTING LATTICE TOWER. PROVIDE #2 BARE SOLID TINNED COPPER CONDUCTOR FROM EXOTHERMIC WELD CONNECTION AT EXTERIOR GROUND RING TO EXOTHERMIC WELD CONNECTION AT BASE OF TOWER, TYP.
- NEW 12'-0" X 30'-0" EQUIPMENT SHELTER.
- PROVIDE #2 BARE SOLID TINNED COPPER CONDUCTOR LOCATED 30" BELOW FINISH GRADE FOR EXTERIOR GROUND RING AT TOWER AND EQUIPMENT SHELTER.
- PROVIDE 3/4" DIAMETER x 10'-0" LONG COPPER CLAD GROUND ROD, MINIMUM 30" BELOW GRADE, AT MINIMUM 10'-0" O.C.
- GROUND INSPECTION AND TEST WELL. SEE DETAIL FOR CONSTRUCTION REQUIREMENTS. MIN (1) ONE PER GROUND RING.
- PROVIDE #2 BARE SOLID TINNED COPPER CONDUCTOR FROM EXOTHERMIC WELD CONNECTION AT EXTERIOR GROUND RING TO INTERIOR HALO GROUND RING.
- NEW UTILITY METER W/ MAIN BREAKER GROUNDING. #2 BARE SOLID TINNED COPPER CONDUCTOR FROM EXOTHERMIC WELD CONNECTION AT EXTERIOR GROUND RING TO MECHANICAL CONNECTION AT ELECTRICAL ENCLOSURE. PROVIDE EXOTHERMIC WELD CONNECTION TO NEW GROUND ROD.
- PROVIDE #2 BARE SOLID TINNED COPPER CONDUCTOR FOR GROUND CONNECTION TO WAVEGUIDE BRIDGE PIPE SUPPORT. PROVIDE GROUND CONNECTION AT EACH PIPE SUPPORT.
- NEW COLLECTION GROUND BAR MOUNTED AT ANTENNA LEVEL OF TOWER. PROVIDE #2 INSULATED SHAWED COPPER CONDUCTOR TO MECHANICAL CONNECTION AT MASTER GROUND BAR AT BASE OF TOWER.
- NEW MASTER GROUND BAR MOUNTED AT BASE OF TOWER. PROVIDE (2) #2 BARE SOLID TINNED COPPER CONDUCTORS TO EXOTHERMIC WELD CONNECTION AT EXTERIOR GROUND RING.
- PROVIDE (2) #2 BARE SOLID TINNED COPPER CONDUCTOR FROM EXOTHERMIC WELD CONNECTION AT TOWER GROUND RING TO EXOTHERMIC WELD CONNECTION AT EQUIPMENT SHELTER GROUND RING. SEPARATE AS MUCH AS FEASIBLE.
- MICROWAVE ANTENNA GROUNDING. #2 BARE SOLID TINNED COPPER CONDUCTOR FROM MECHANICAL CONNECTION AT COLLECTION GROUND BAR TO EXOTHERMIC WELD CONNECTION AT MICROWAVE ANTENNAS, TYP.
- ENCLOSED DIPOLE ANTENNA WITH REFLECTOR GROUNDING. #2 BARE SOLID TINNED COPPER CONDUCTOR FROM MECHANICAL CONNECTION AT COLLECTION GROUND BAR TO MECHANICAL CONNECTION AT ENCLOSED DIPOLE ANTENNAS, TYP.
- ENCLOSED DIPOLE ARRAY ANTENNA GROUNDING. #2 BARE SOLID TINNED COPPER CONDUCTOR FROM MECHANICAL CONNECTION AT COLLECTION GROUND BAR TO MECHANICAL CONNECTION AT ENCLOSED DIPOLE ANTENNAS, TYP.
- GPS GROUNDING. #2 BARE SOLID TINNED COPPER CONDUCTOR FROM EXOTHERMIC WELD CONNECTION AT GROUND RING TO MECHANICAL CONNECTION AT GPS ANTENNA, TYP.
- FENCE POST AND GATE GROUNDING. #2 AWG TINNED SOLID BARE COPPER CONDUCTORS FROM EXOTHERMIC WELD CONNECTION AT EXTERIOR GROUND RING TO EXOTHERMIC WELD CONNECTION AT NEW FENCE POST AND GATE. PROVIDE CONNECTION AT EACH FENCE CORNER POST. PROVIDE FLEXIBLE MECHANICAL CONNECTION AT FENCE GATE AND POST.
- FUEL TANK GROUNDING. #2 BARE SOLID TINNED COPPER CONDUCTOR FROM EXOTHERMIC WELD CONNECTION AT GROUND RING TO MECHANICAL CONNECTION AT FUEL TANK GROUNDING LUG.
- SAFETY BOLLARD GROUNDING. #2 BARE SOLID TINNED COPPER CONDUCTOR FROM EXOTHERMIC WELD CONNECTION AT GROUND RING TO EXOTHERMIC WELD CONNECTION AT BOLLARD, TYP.
- EXTERNAL GROUND BAR MOUNTED BELOW ENTRY PORT AT EQUIPMENT SHELTER. PROVIDE (2) #2 BARE SOLID TINNED COPPER CONDUCTORS TO EXOTHERMIC WELD CONNECTION AT NEW EXTERIOR GROUND RING.

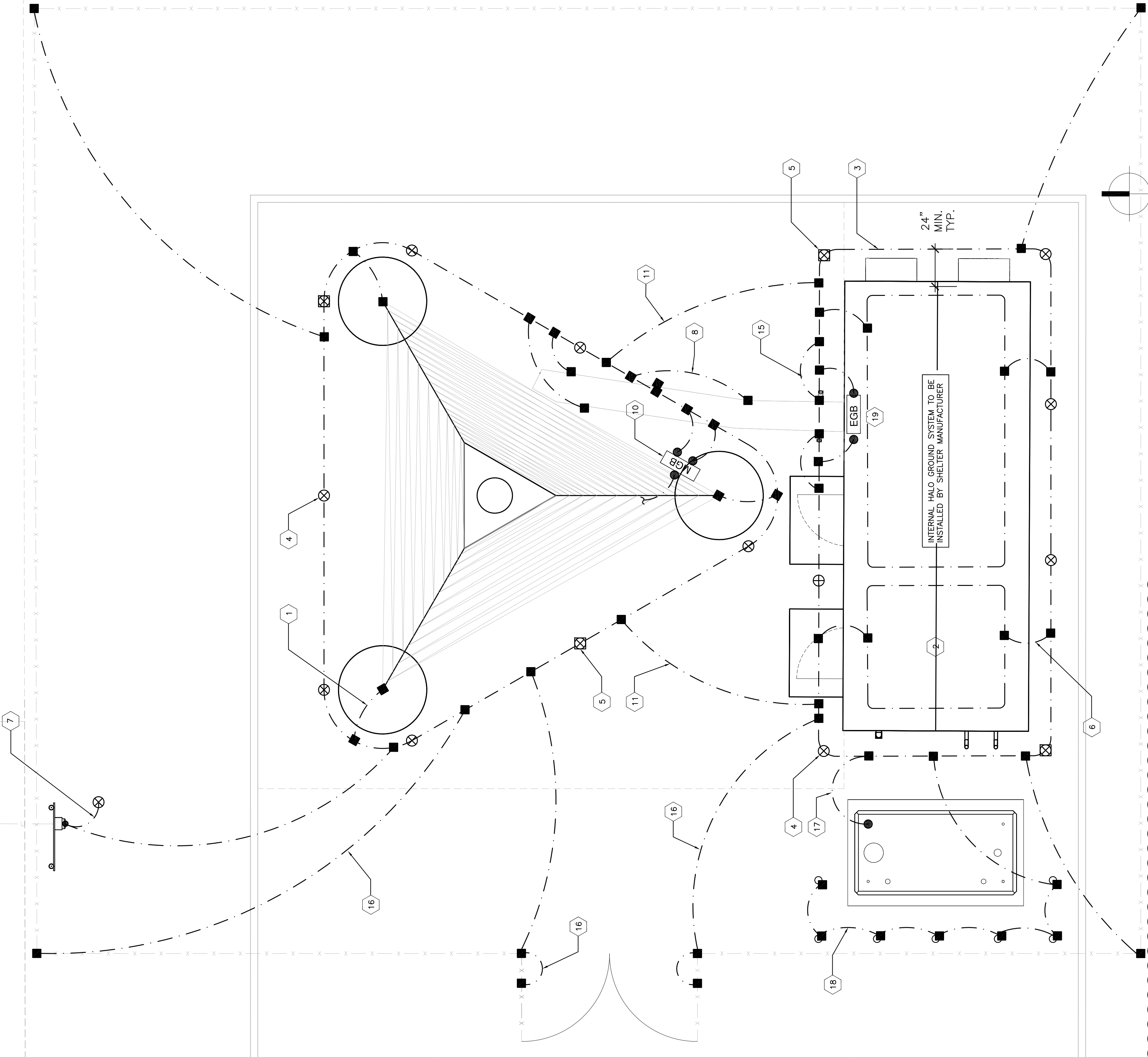

1 ELECTRICAL GROUNDING PLAN @ GRADE

SCALE: 1/4" = 1'-0" (22x34), 1/8" = 1'-0" (11x17)

NORTH



SWAN
(NEW BUILD)
39025 NE NORTH FORK RD.
DUVALL, WA 98019

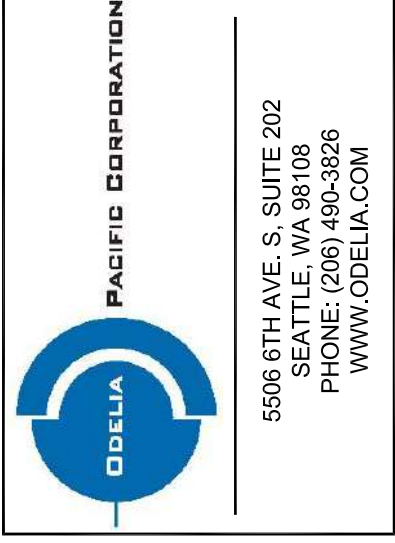

PROJECT MANAGER: E/C

PREPARED BY: A/O/EAT

APPROVED BY: PN

▲	07/31/17	UPDATED SURVEY
▲	07/21/17	DPER COMMENTS
▲	06/27/17	ELECTRICAL TIE-IN W/ SCL
▲	06/15/17	ISSUED FOR PERMIT

PLAN REVIEWERS SIGNATURE



SHEET NAME
GROUNDING PLANS & NOTES

SHEET NUMBER
E-3.1

GENERAL NOTES.

- ALL CADWELD CONNECTIONS ON GALVANIZED SURFACES SHALL BE CLEANED THOROUGHLY AND COVERED WITH TWO (2) COATS OF SHERWIN WILLIAMS GALVANITE B550W3 OR EQUAL.
- ALL ELECTRICAL CADWELD AND MECHANICAL GROUND CONNECTIONS WILL HAVE NON-OXIDATION COMPOUND APPLIED TO CONNECTION.
- ANY METAL OBJECTS WITHIN 6 FEET OF THE EXTERNAL GROUND RING SHALL BE GROUNDING.
- ALL GROUNDING MATERIALS AND CADWELD MOLDS, SHOTS, ETC. SHALL BE FURNISHED AND INSTALLED BY CONTRACTOR UNLESS OTHERWISE NOTED.
- THE ELECTRICAL CONTRACTOR SHALL FOLLOW GROUNDING SYSTEM INSTALLED AND TESTING PROCEDURES AS DESCRIBED IN THE GENERAL ELECTRICAL PROVISIONS.
- CONNECTIONS TO THE GROUND BUS SHALL NOT BE DOUBLED UP OR STACKED. BACK TO BACK CONNECTIONS ON OPPOSITE SIDES OF THE GROUND BUS ARE PERMITTED.
- USE OF 90° BENDS IN THE PROTECTION GROUNDING CONDUCTORS SHALL BE AVOIDED WHEN 45° BENDS CAN BE ADEQUATELY SUPPORTED.
- OBSERVE NEC AND LOCAL UTILITY REQUIREMENTS FOR ELECTRICAL SERVICE GROUNDING.
- MAXIMUM RESISTANCE OF THE COMPLETED GROUND SYSTEM SHALL NOT EXCEED 5 OHMS.
- SITE TO COMPLY WITH R66 STANDARDS FOR GROUNDING.

ITEM	LEGEND	DESCRIPTION
⊗		3/4" DIAMETER x 10'-0" LONG COPPER CLAD GROUND ROD, MINIMUM 30" BELOW GRADE, AT MINIMUM 10'-0" O.C. (LARGER #5619).
⊠		CADWELD INSPECTION WELL.
—		#2 AWG TINNED SOLID BARE COPPER WIRE, MINIMUM 30" BELOW GRADE, OR 6" BELOW LOCAL FROST LINE.
■		CADWELD/EXOTHERMIC WELD CONNECTION.
●		MECHANICAL CONNECTION.

KEYED NOTES.

- NEW 235' HIGH SELF-SUPPORTING LATTICE TOWER. PROVIDE #2 BARE SOLID TINNED COPPER CONDUCTOR FROM EXOTHERMIC WELD CONNECTION AT EXTERIOR GROUND RING TO EXOTHERMIC WELD CONNECTION AT BASE OF TOWER, TYP.
- NEW 12'-0" x 30'-0" EQUIPMENT SHELTER.
- PROVIDE #2 BARE SOLID TINNED COPPER CONDUCTOR LOCATED 30" BELOW FINISH GRADE FOR EXTERIOR GROUND RING AT TOWER AND EQUIPMENT SHELTER.
- PROVIDE 3/4" DIAMETER x 10'-0" LONG COPPER CLAD GROUND ROD, MINIMUM 30" BELOW GRADE, AT MINIMUM 10'-0" O.C.
- GROUND INSPECTION AND TEST WELL. SEE DETAIL FOR CONSTRUCTION REQUIREMENTS. MIN (1) ONE PER GROUND RING.
- PROVIDE #2 BARE SOLID TINNED COPPER CONDUCTOR FROM EXOTHERMIC WELD CONNECTION AT EXTERIOR GROUND RING TO INTERIOR HALO GROUND RING.
- NEW UTILITY METER W/ MAIN BREAKER GROUNDING, #2 BARE SOLID TINNED COPPER CONDUCTOR FROM EXOTHERMIC WELD CONNECTION AT EXTERIOR GROUND RING TO MECHANICAL CONNECTION AT ELECTRICAL ENCLOSURE. PROVIDE EXOTHERMIC WELD CONNECTION TO NEW GROUND ROD.
- PROVIDE #2 BARE SOLID TINNED COPPER CONDUCTOR FOR GROUND CONNECTION TO WATGUIDE BRIDGE PIPE SUPPORT. PROVIDE GROUND CONNECTION AT EACH PIPE SUPPORT.
- NEW COLLECTION GROUND BAR MOUNTED AT ANTENNA LEVEL OF TOWER. PROVIDE #2 INSULATED STRANDED COPPER CONDUCTOR TO MECHANICAL CONNECTION AT MASTER GROUND BAR AT BASE OF TOWER.
- NEW MASTER GROUND BAR MOUNTED AT BASE OF TOWER. PROVIDE (2) #2 BARE SOLID TINNED COPPER CONDUCTORS TO EXOTHERMIC WELD CONNECTION AT EXTERIOR GROUND RING.
- PROVIDE (2) #2 BARE SOLID TINNED COPPER CONDUCTOR FROM EXOTHERMIC WELD CONNECTION AT TOWER GROUND RING TO EXOTHERMIC WELD CONNECTION AT EQUIPMENT SHELTER GROUND RING. SEPARATE AS MUCH AS FEASIBLE.
- MICROWAVE ANTENNA GROUNDING. #2 BARE SOLID TINNED COPPER CONDUCTOR FROM MECHANICAL CONNECTION AT COLLECTION GROUND BAR TO EXOTHERMIC WELD CONNECTION AT MICROWAVE ANTENNAS, TYP.
- ENCLOSED DIPOLE ANTENNA WITH REFLECTOR GROUNDING, #2 BARE SOLID TINNED COPPER CONDUCTOR FROM MECHANICAL CONNECTION AT COLLECTION GROUND BAR TO MECHANICAL CONNECTION AT ENCLOSED DIPOLE ANTENNAS, TYP.
- ENCLOSED DIPOLE ARRAY ANTENNA GROUNDING. #2 BARE SOLID TINNED COPPER CONDUCTOR FROM MECHANICAL CONNECTION AT COLLECTION GROUND BAR TO MECHANICAL CONNECTION AT ENCLOSED DIPOLE ANTENNAS, TYP.
- GPS GROUNDING, #2 BARE SOLID TINNED COPPER CONDUCTOR FROM EXOTHERMIC WELD CONNECTION AT GROUND RING TO MECHANICAL CONNECTION AT GPS ANTENNA, TYP.
- FENCE POST AND GATE GROUNDING. #2 AWG TINNED SOLID BARE COPPER CONDUCTORS FROM EXOTHERMIC WELD CONNECTION AT EXTERIOR GROUND RING TO EXOTHERMIC WELD CONNECTION AT NEW FENCE POST AND GATE. PROVIDE CONNECTION AT EACH FENCE CORNER POST. PROVIDE FLEXIBLE MECHANICAL CONNECTION AT FENCE GATE AND POST.
- FUEL TANK GROUNDING. #2 BARE SOLID TINNED COPPER CONDUCTOR FROM EXOTHERMIC WELD CONNECTION AT GROUND RING TO MECHANICAL CONNECTION AT FUEL TANK GROUNDING LUG.
- SAFETY BOLLARD GROUNDING. #2 BARE SOLID TINNED COPPER CONDUCTOR FROM EXOTHERMIC WELD CONNECTION AT GROUND RING TO EXOTHERMIC WELD CONNECTION AT BOLLARD, TYP.
- EXTERNAL GROUND BAR MOUNTED BELOW ENTRY PORT AT EQUIPMENT SHELTER. PROVIDE (2) #2 BARE SOLID TINNED COPPER CONDUCTORS TO EXOTHERMIC WELD CONNECTION AT NEW EXTERIOR GROUND RING.

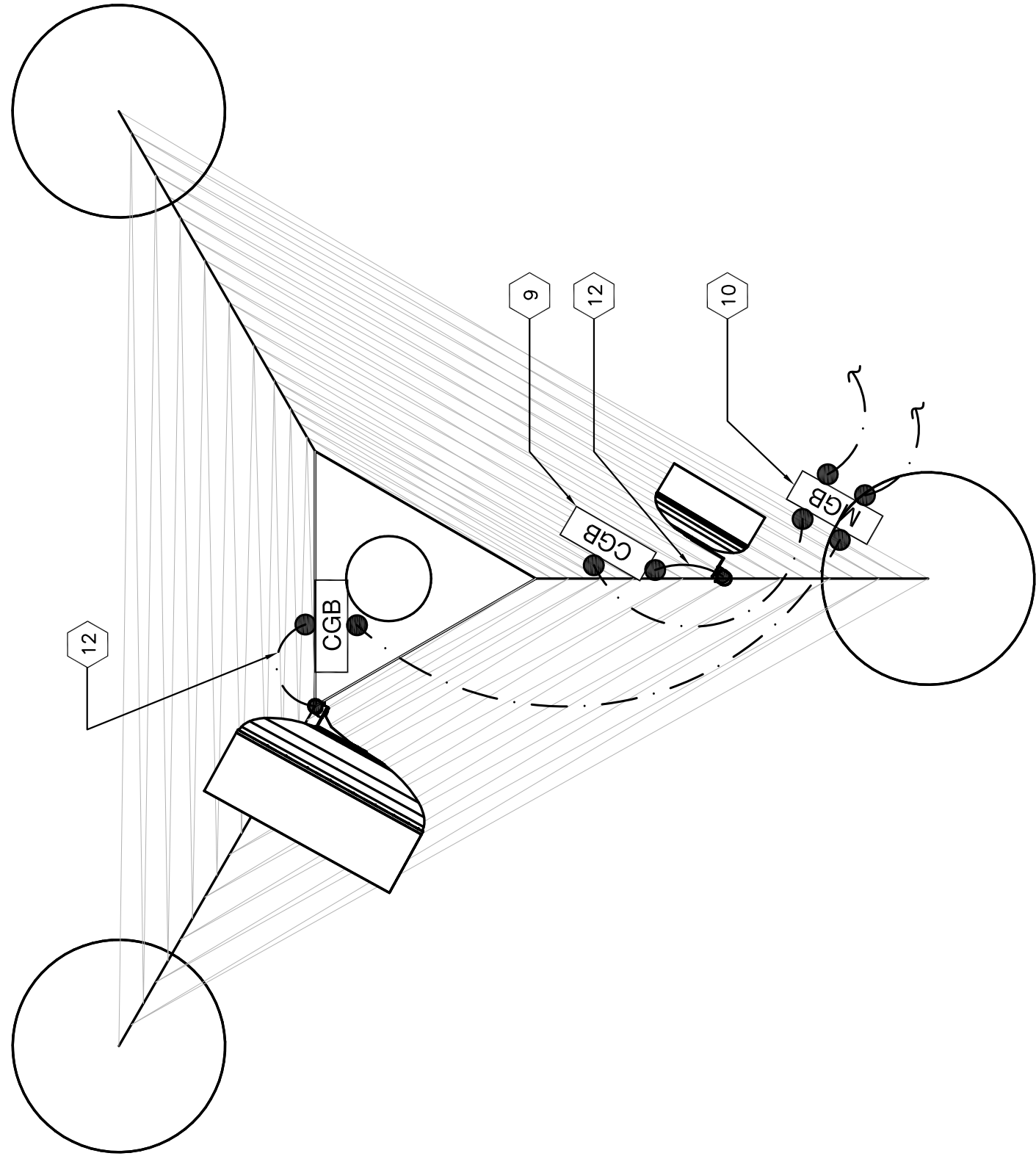

1 ANTENNA GROUNDING PLAN @ 230'-0"

SCALE: 1/4" = 1'-0" (22x34), 1/8" = 1'-0" (11x17)

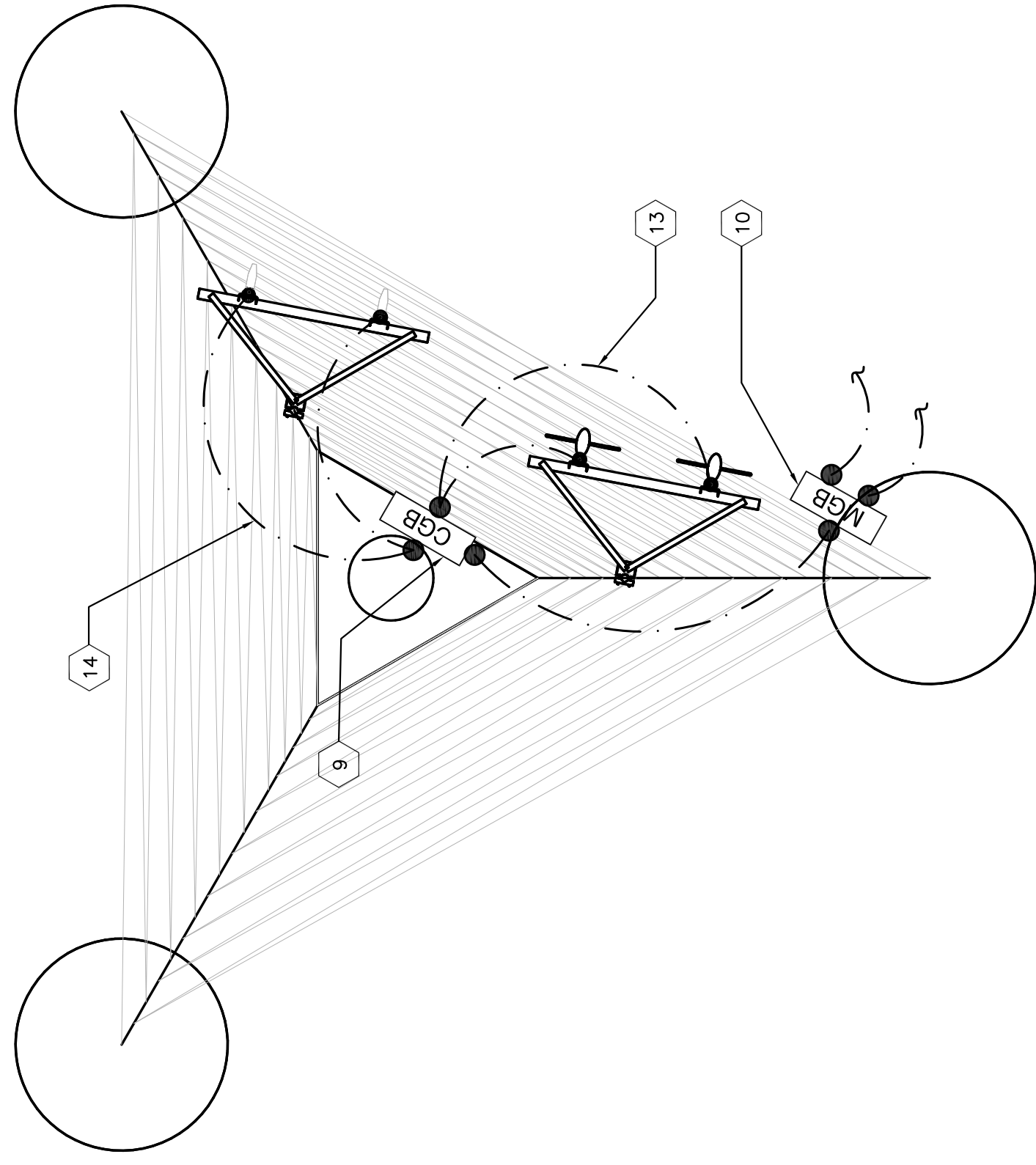
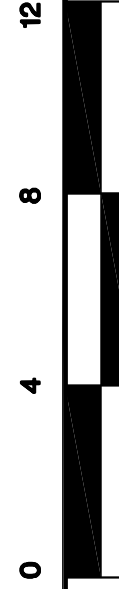
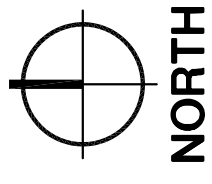

2 ANTENNA GROUNDING PLAN @ 170'-0"

SCALE: 1/4" = 1'-0" (22x34), 1/8" = 1'-0" (11x17)

